

# BRIMAR

## RECEIVING VALVE 6AT6

### APPLICATION REPORT VAD/511.2

This document is issued by S. T. & C. Ltd. on condition that it is not copied or reprinted either wholly or in part without the consent in writing of S. T. & C. Ltd.

The publication of information in this document does not imply freedom from patent rights of S. T. & C. Ltd. or others, nor is any responsibility or liability assumed or accepted.

The right is reserved to make any modifications to the data herein without prior notice.

*Standard Telephones and Cables Limited*

FOOTSCRAY, KENT, ENGLAND

**INTRODUCTION:** The Brimar 6AT6 is an indirectly heated miniature double diode triode. The triode unit and the diode unit are separate but have a common cathode. This report contains characteristics of the valve and details of its use as second detector in superheterodyne receivers.

**DESCRIPTION:** The valve comprises two units mounted one above the other; the diode unit is screened from the triode unit. The triode unit is of the high  $\mu$  type and the whole is mounted in a standard T5 $\frac{1}{2}$  bulb and based with a B.V.A. standard base type B7G.

**CHARACTERISTICS:** Indirectly-heated oxide-coated cathode.

Heater Voltage	6.3 volts
Heater Current	0.3 amperes
Max. DC Heater-Cathode potential	250 volts

**DIMENSIONS:**

Max. Overall Length	2-1/8 ins.
Max. Diameter	3/4 in.
Max. Seated Height (excluding tip)	1-19/32 ins.

**BASE:** Type B7G

**BASE CONNECTIONS:**

- Pin 1 Triode Grid
- Pin 2 Cathode and Shield
- Pin 3 Heater
- Pin 4 Heater
- Pin 5 Diode Anode 2
- Pin 6 Diode Anode 1
- Pin 7 Triode Anode

**MAXIMUM RATINGS:**

Triode Unit:	
Max. Anode Voltage	300 volts
Max. Anode Dissipation	1.0 watts
Diode Unit:	
Max. Anode Current	1.0 mA

**CAPACITIES (approx.):** Measured with no external shield.

$c_{g, a}$	2.1 pF
c Input	2.3 pF
c Output	1.1 pF
$c_{h, k}$	3.5 pF
$c_{a' d, k}$	0.65 pF
$c_{a'' d, k}$	1.4 pF
$c_{a' d, a'' d}$	1.0 pF
Cat, a' d; Cat, a'' d	0.4 pF
$c_{g, a' d}; c_{g, a'' d}$	0.025 pF max.

**CHARACTERISTIC CURVES:** Curves are attached to this report showing:

- a. Triode anode current plotted against anode voltage for various values of grid voltage (Curve No. 311.11).
- b. Triode anode current plotted against grid voltage for various anode voltages (Curve No. 311.12).
- c. Mutual conductance ( $g_m$ ), amplification factor ( $\mu$ ) and anode impedance ( $r_a$ ) plotted against anode current (Curve No. 311.13).
- d. Diode anode current against anode voltage (Curve No. 311.14).

## TYPICAL OPERATING CONDITIONS

TRIODE UNIT:

### Class A Amplifier:

Heater Voltage	6.3	6.3	volts
Anode Voltage	100	250	volts
Grid Voltage	-1	-3	volts
Amplification Factor	70	70	
Anode Impedance	54,000	58,000	ohms
Mutual Conductance	1.3	1.2	mA/V
Anode Current	0.8	1.0	mA

**Resistance-Capacity Coupled Amplifier:** The valve is very suitable for use as a resistance coupled amplifier and below is a table giving a summary of useful values at two different supply voltages for a distortion of approximately 4%.

#### a. Anode Supply Voltage $V_{a(b)}$ 100 volts:

Anode Load ( $R_a$ megohms)	0.10	0.10	0.22	0.22	0.47	0.47
Grid Leak (succeeding valve) (megohms)	0.22	0.47	0.22	0.47	0.47	1.0
Cathode Resistor (ohms)	4700	4800	7000	7800	12000	14000
Output Voltage (peak)	7.5	9.1	7.3	10	10	14
Voltage Gain	27	30	30	34	36	39

#### b. Anode Supply Voltage $V_{a(b)}$ 250 volts:

Anode Load ( $R_a$ megohms)	0.10	0.10	0.22	0.22	0.47	0.47
Grid Leak (succeeding valve) (megohms)	0.22	0.47	0.22	0.47	0.47	1.0
Cathode Resistor (ohms)	1800	2100	2600	3300	5200	6000
Output Voltage (peak)	40	47	38	49	45	56
Voltage Gain	36	40	40	45	46	48

A graph is attached which shows the relationship of the various valve parameters under conditions of resistance capacity coupling. This graph (311.15) is taken at an anode supply voltage,  $V_{a(b)}$  of 250 volts with three values of anode load resistance, viz. 100,000, 220,000 and 470,000 ohms, and plots the anode current, amplification factor, mutual conductance and anode impedance against grid voltage. From this graph the correct grid bias (cathode resistor) can be obtained, also the stage gain can be calculated and an estimate made of the distortion. The graph is not drawn beyond the limits of the commencement of grid current or around the grid cut-off region. Below follows a description of the method of using this graph.

If, for example, it is desired to use a valve at a supply voltage of 250 volts, an anode load of 100,000 ohms, and a succeeding valve grid leak of 470,000 ohms, then to determine the grid bias, an inspection of the graph indicates a linear portion of the curve of anode current/grid voltage over the range of -1 to -3 volts, the mid point being -2 volts. At this point the anode current is 0.75 mA, hence the cathode resistor should be 2700 ohms. The peak input voltage is 1 volt and the r.m.s. input 0.7 volts. Following the grid bias voltage upward it is evident that with an anode load of 100,000 ohms, the amplification factor is 78 and the anode impedance is 62,000 ohms. The anode load is effectively in parallel with the succeeding valve grid leak as regards the signal but not as regards the anode current, hence the effective signal value of the anode load is 100,000 ohms in parallel with 470,000 ohms or is 83,000 ohms. The stage gain is:

$$\frac{\mu R_a}{R_a + r_a} = \frac{78 \times 83,000}{83,000 + 62,000} = 45.$$

or in the above case:

The peak input voltage above was 1 volt, hence the peak output voltage will be this figure multiplied by the stage gain or 45 volts (31 volts r.m.s.).

An estimate of the distortion may be made by calculating from the graph, as above, the stage gain at the extremes of grid bias. In the example the stage gain at  $-1$  volt is 51 and at  $-3$  volts is 31, hence the second harmonic distortion will be approximately 10% at this input.

**Zero Bias Operation:** The triode unit may also be used with a high value grid resistor, the bias being provided by contact potential. A summary of useful values employing a 10 megohm grid resistor and two different supply voltages for a distortion of 5% are given below.

**a. Anode Supply Voltage  $V_a$ (b) 100 volts:**

Anode Load ( $R_a$ megohms)	0.22	0.22	0.47	0.47
Grid Leak (succeeding valve) (megohms)	0.22	0.47	0.47	1.0
Output Voltage (peak)	7	10	10.5	14
Voltage Gain	31	37	39	40

**b. Anode Supply Voltage  $V_a$ (b) 250 volts:**

Anode Load ( $R_a$ megohms)	0.22	0.22	0.47	0.47
Grid Leak (succeeding valve) (megohms)	0.22	0.47	0.47	1.0
Output Voltage (peak)	42	54	47	60
Voltage Gain	46	51	53	56

**DIODE UNIT:**

**Half-Wave Rectification:** A graph is attached which shows the performance of either diode when used as a signal rectifier (Curve No. 311.16). Load lines have been drawn for DC loads of 0.1, 0.22, 0.47 and 1.0 megohm. It should be remembered that in order to determine the performance, further load lines must be drawn through the operating point, having a slope equal to the load presented by the AC and DC loads in parallel.

**Full-Wave Rectification:** The diodes may be employed as signal rectifiers in a full-wave circuit if required.

**Combined Detector and AF Amplifier:** The circuit (Ref. 311.55) attached shows a typical arrangement suitable for a receiver of good average performance. The IF pentode may be a type such as a Brimar 6BA6 and a following output valve may be a Brimar 6AQ5, 6BW6 or 6L6G. Using the values shown the distortion at 60% modulation will be of the order of 1.7% of second harmonic and 0.3% of third harmonic, and at 100% modulation 5% of second harmonic and 2% of third harmonic for an output of 10 volts r.m.s.

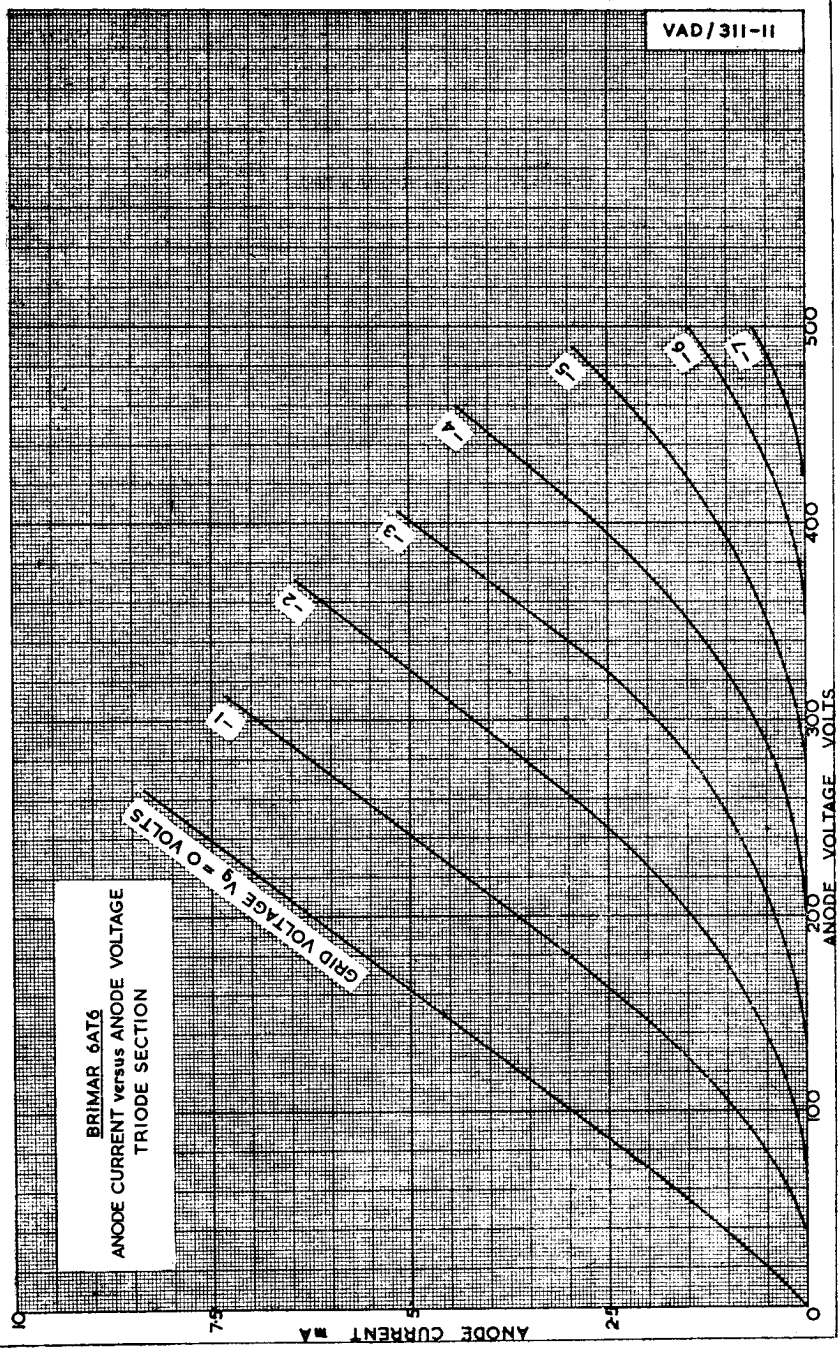

BRIMAR 6AT6  
ANODE CURRENT versus ANODE VOLTAGE  
TRIODE SECTION

GRID VOLTAGE  $V_{g1} = 0$  VOLTS

ANODE CURRENT MA

ANODE VOLTAGE VOLTS

VAD/311-12

**BRIMAR 6AT6**  
ANODE CURRENT versus GRID VOLTAGE

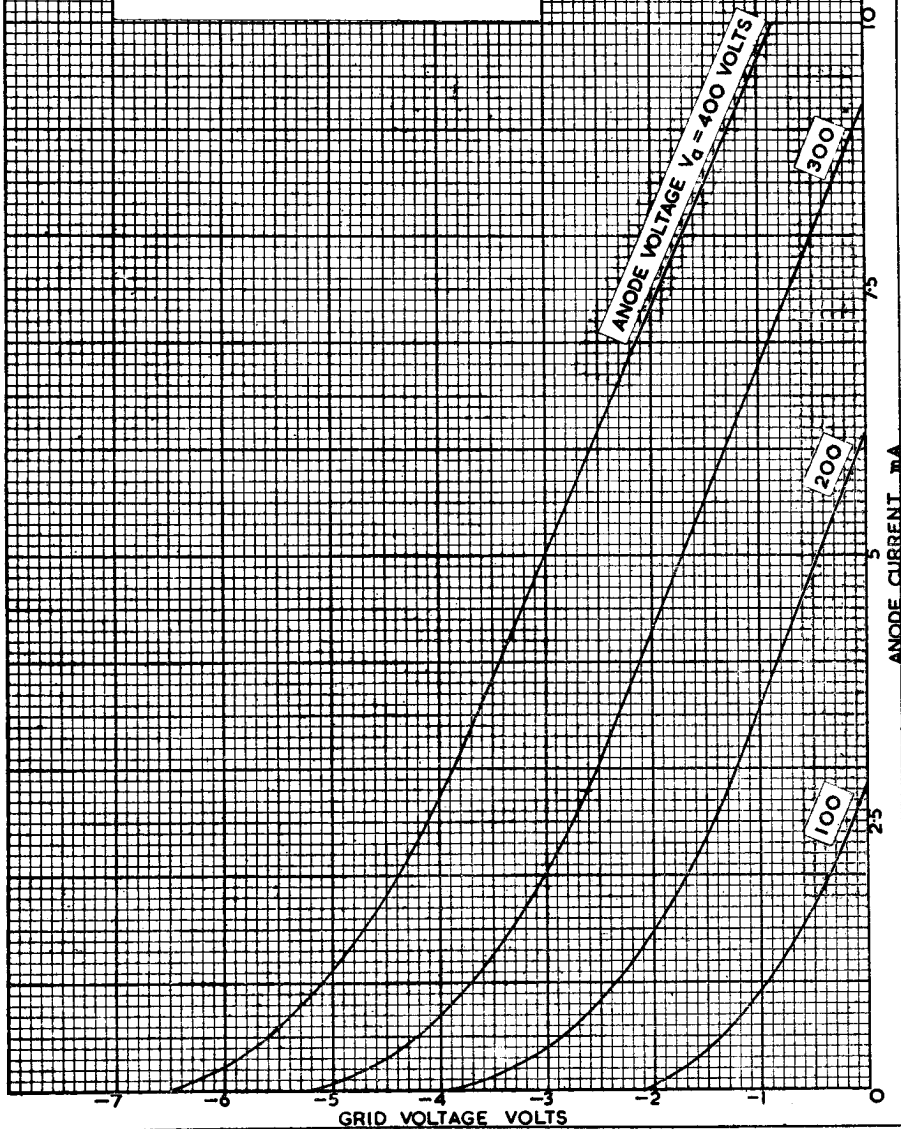

VAD/311-13

**BRIMAR 6AT6**

ANODE VOLTAGE  $V_a = 250$  VOLTS

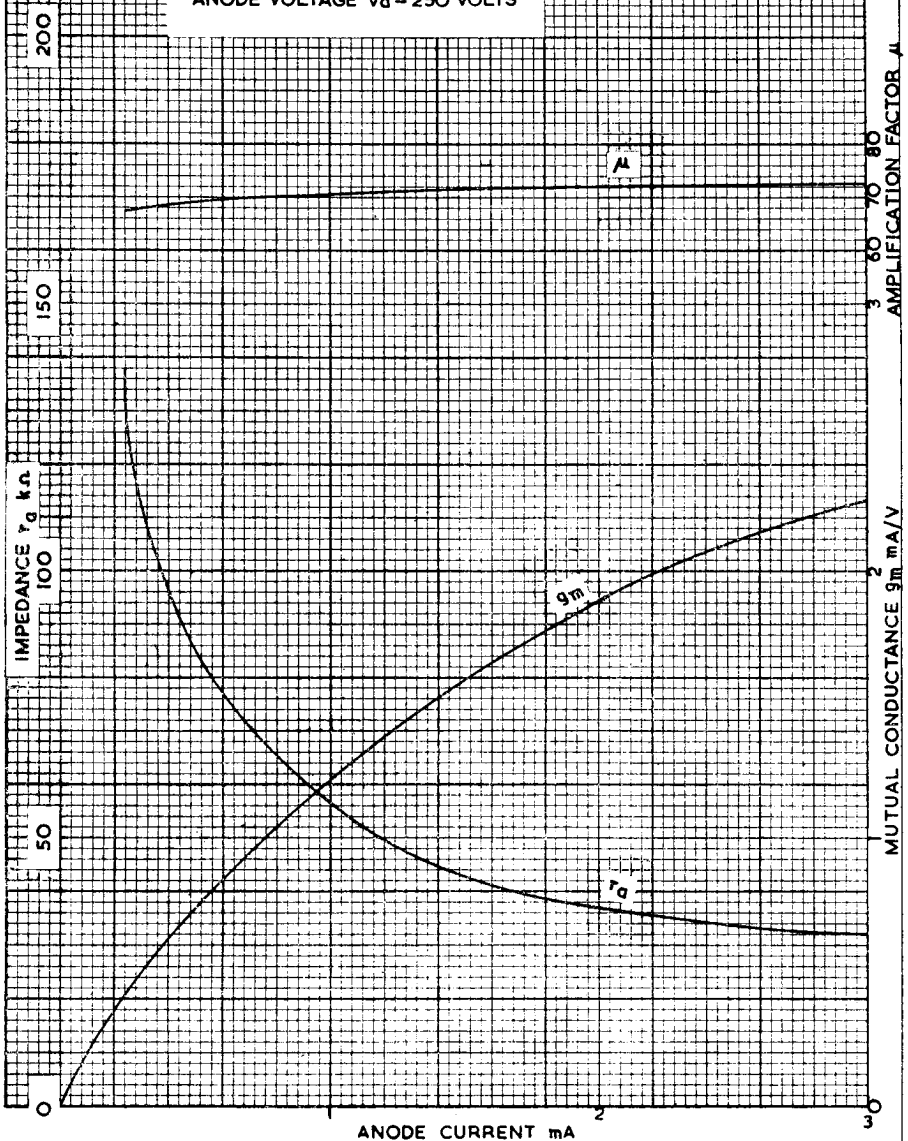

ANODE CURRENT mA

IMPEDANCE  $r_a$   $k\Omega$

AMPLIFICATION FACTOR  $\mu$

MUTUAL CONDUCTANCE  $g_m$  mA/V

VAD/311-14

BRIMAR 6AT6  
ANODE CURRENT versus ANODE VOLTAGE  
EACH DIODE

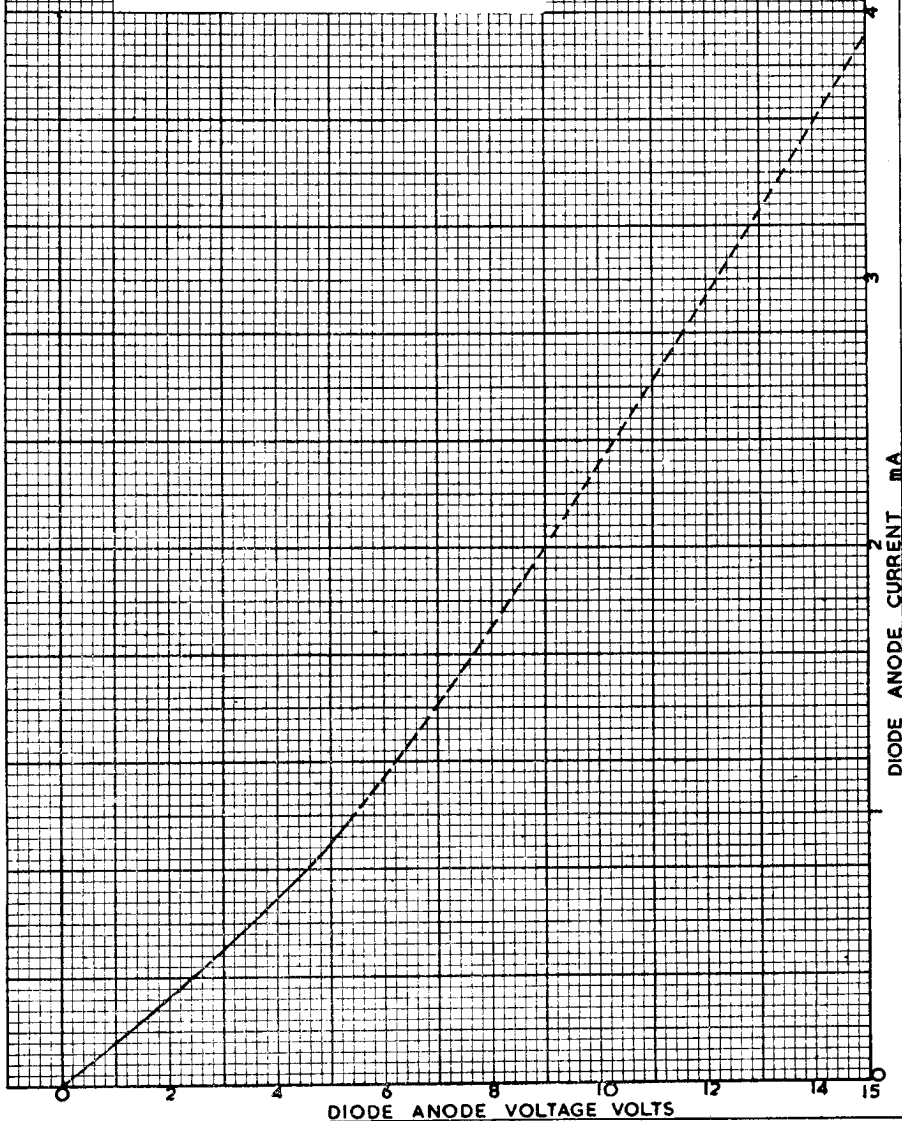



BRIMAR 6AT6  
 R.C. COUPLING CURVES  
 ANODE LOADS  
 1)  $R_a$  100 k $\Omega$   
 2)  $R_a$  220 k $\Omega$   
 3)  $R_a$  470 k $\Omega$

$V_{a(b)} \approx 250$  VOLTS

VAD/311-15

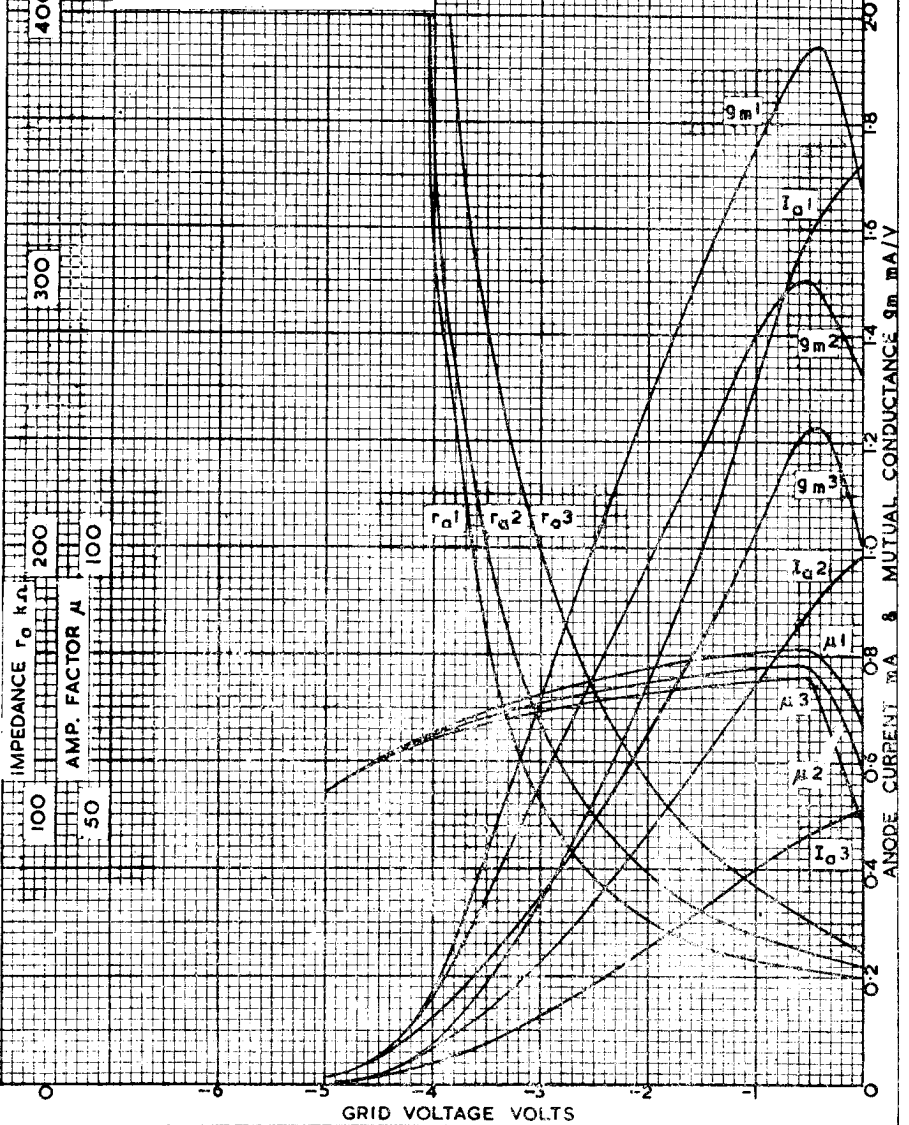

BRIMAR 6AT6  
OPERATION AS HALF WAVE RECTIFIER  
EACH DIODE

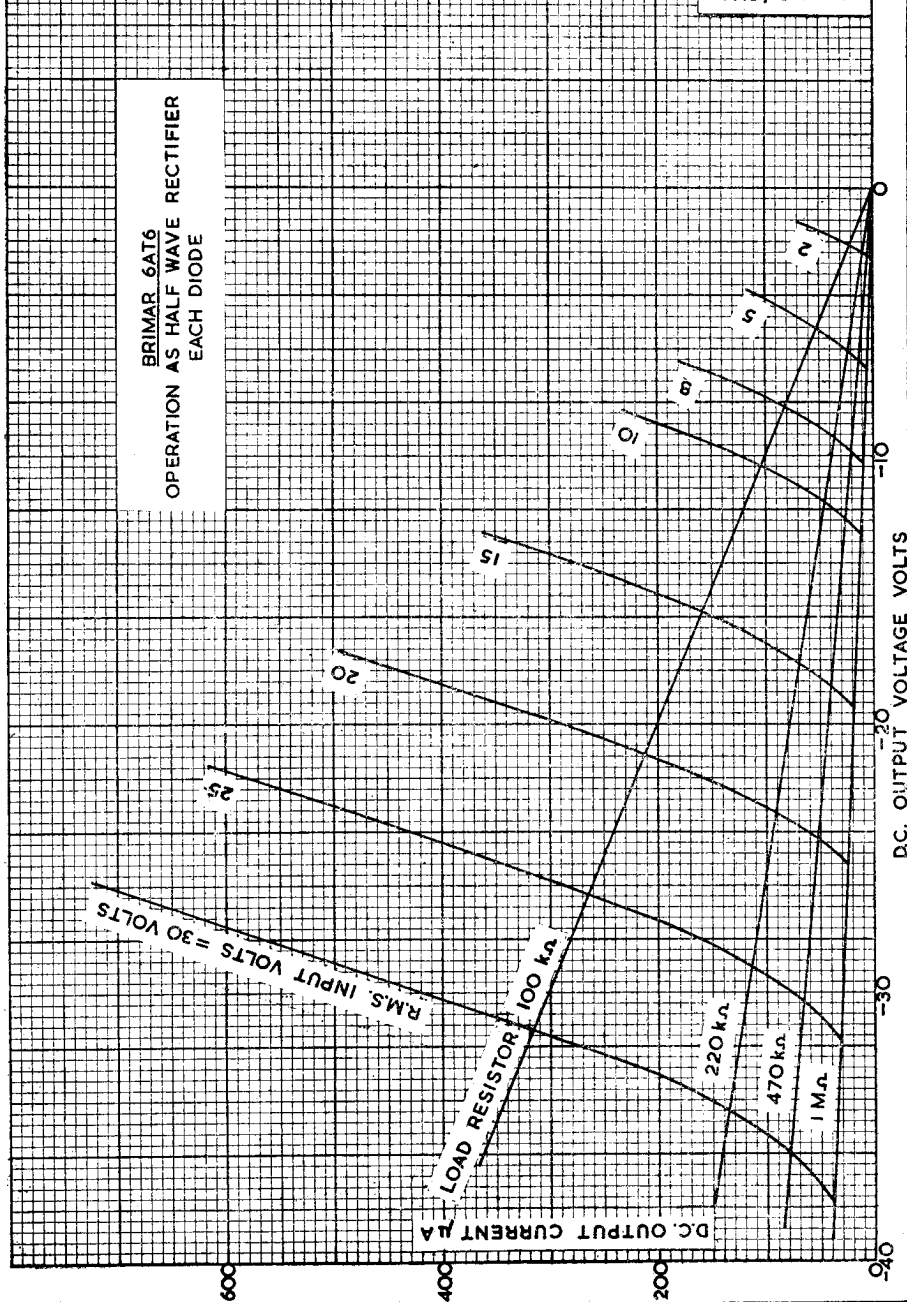

R.M.S. INPUT VOLTS = 30 VOLTS

LOAD RESISTOR 100 kΩ

220 kΩ

470 kΩ

1 MΩ

DC. OUTPUT CURRENT mA

DC. OUTPUT VOLTAGE VOLTS

# BRIMAR 6AT6 COMBINED DETECTOR & A.F. AMPLIFIER

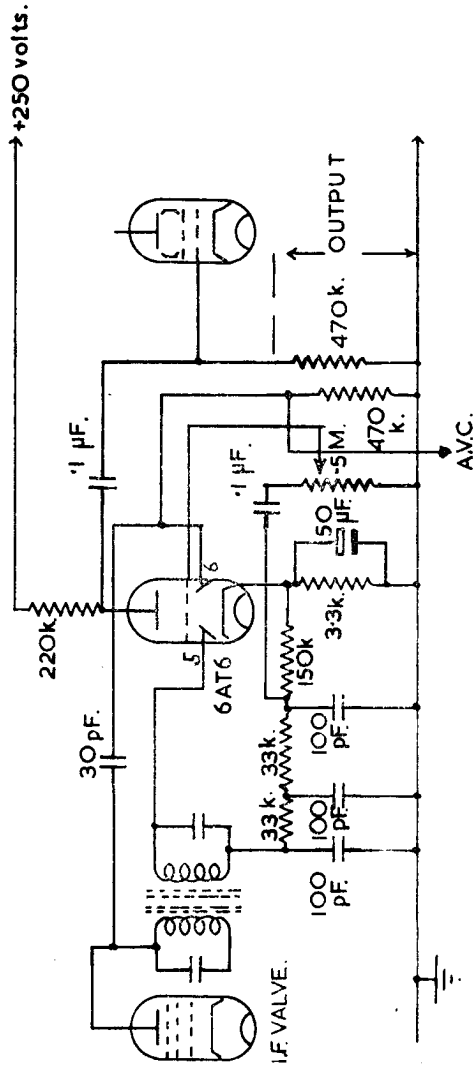

FREQUENCY 465 kc/s.