



CMA 1246 CARCINOTRON

The CMA.1246 is a rugged, compact, electronically tunable, crossfield, backward wave oscillator. Its light weight makes it suitable for airborne equipments. Sturdy metal-ceramic construction insures reliable performance in spite of severe environmental conditions.

This M type carcinotron provides an output of at least 500 W over the frequency range of 2.60 to 3.40 GHz. The tube tunes over the entire frequency range by changing the line or sole voltage.

It can be amplitude modulated through its anode. Frequency modulation can be obtained by line or sole voltage variations.

The CMA.1246 uses integral permanent magnet focusing. Liquid cooling insures operation in a wide temperature range.

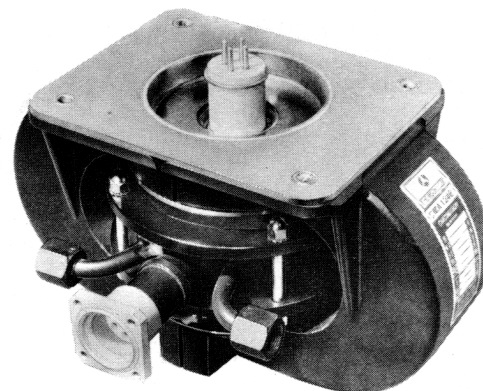

GENERAL CHARACTERISTICS

Electrical (1)

	min.	max.	
Heater voltage		6.3	V
Heater current	2.0	5.5	A
Output power	500	-	W
Frequency range	2.60	3.40	GHz
Interelectrodes capacitances :			
Sole to all other electrodes	-	90	pF
Anode to all other electrodes	-	20	pF
Line to all other electrodes	-	100	pF
Sole voltage	-2000	-700	V
Sole current	-150	+10	mA
Grid voltage	-800	0	V
Grid current	-5	+5	mA
Anode voltage	-	2.0	kV
Anode current	-3	+3	mA
Line voltage	2.5	5.8	kV
Line current		600	mA

Mechanical

Operating position	any
Dimensions	see drawing
Weight	8 kg
RF output connector	UG 46/U

(1) - All voltages are referred to the cathode.



COOLING

WATER

Water flow	min.	4	l/mn
Pressure drop (1)	max.	0.25	bar
Coolant temperature . . .	max.	80	°C
Absolute inlet pressure .	max.	4	bar

COOLANOL 35

Liquid flow	min.	6	l/mn
Pressure drop (1)	max.	0.3	bar
Coolant temperature . . .	max.	80	°C
Absolute inlet pressure .	max.	4	bar

ABSOLUTE RATINGS

(non simultaneous values)

	min.	max.		min.	max.	
Warm-up time	3	—	mn	Sole voltage (3)	-200	+200 V
Heater voltage	6.0	6.6	V	Grid voltage (3)	-50	+50 V
Heater surge current . . .	—	7.5	A	Anode voltage (3)	—	+200 V
Load VSWR (2)	—	3:1		Line voltage	—	6 kV
Ambient temperature . . .	-40	+110	°C	Line current	—	650 mA
Vibration : 5 to 15 Hz	±4 mm			Acceleration	—	15 g
15 to 400 Hz	5 g					

TYPICAL OPERATION

Heater voltage	6.3	V	Oscillating frequency :	2.60	3.40	GHz
Heater current	3.0	A				
Sole voltage	-1.0	kV	Anode voltage	1.40	1.38	kV
Grid voltage	-0.2	kV	Line voltage	3.20	5.70	kV
Grid current	0	mA	Sole current	-20	-70	mA
Line current	600	mA	Output power	690	680	W

OPERATING INSTRUCTIONS

Application of voltages

- Before applying any voltages to the tube, check the coolant flow.
- Apply the heater voltage and allow at least three minutes for the cathode to warm-up.
- Apply grid and sole voltages.
- Apply line voltage. The minimum value of the line voltage given on the tube label is for operating at the lower frequency ; when starting the tube, the voltage applied should be slightly higher.
- Apply reduced anode voltage. Increase the voltage slowly and simultaneously check the line voltage, which should not decrease.
- Adjust the voltages for each particular operation.
- Apply modulation voltages.

Removal of voltages

- First remove the modulation voltages.
- Remove anode voltage.
- Remove line voltage.
- Remove sole, grid and heater voltages.
- Turn off coolant supply to the tube.

Caution

Minimum distance of 15 cm should be kept between the tube and all other magnetic materials.

(1) - 1 bar = approximately 15 psi.
 (2) - The tube may require a load isolator at load VSWR exceeding 1.5 : 1 to maintain the tube performances.
 (3) - These minimum and maximum ratings are the allowable deviation from the nominal value given for each tube.



Characteristic curves

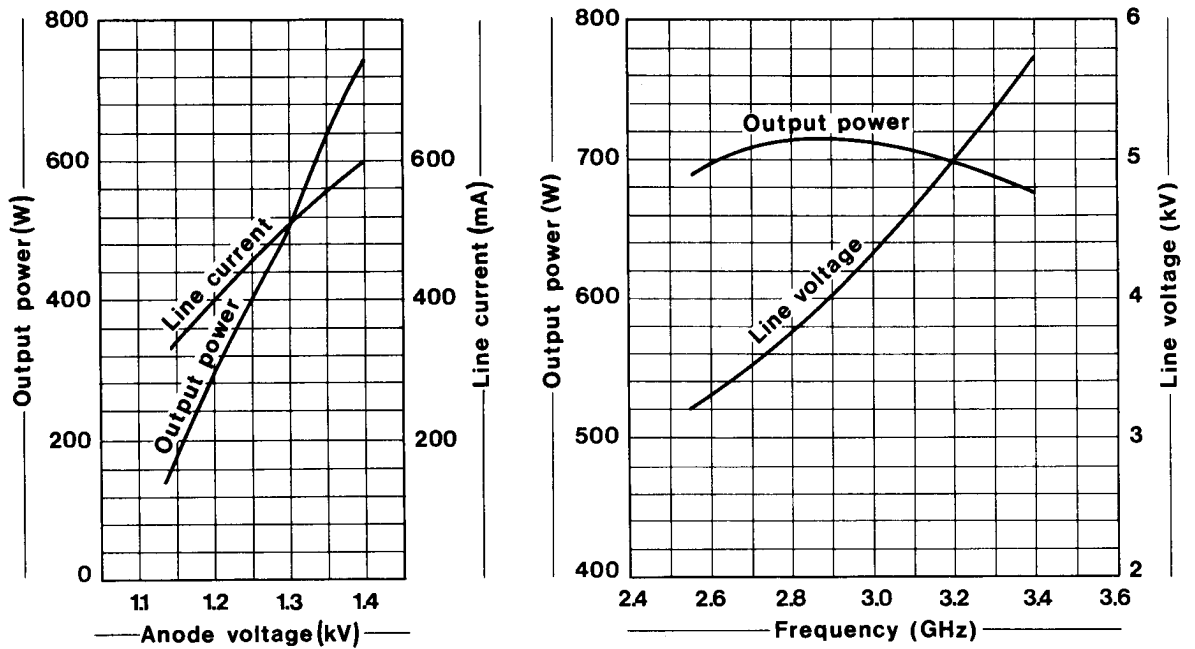

Supply diagram

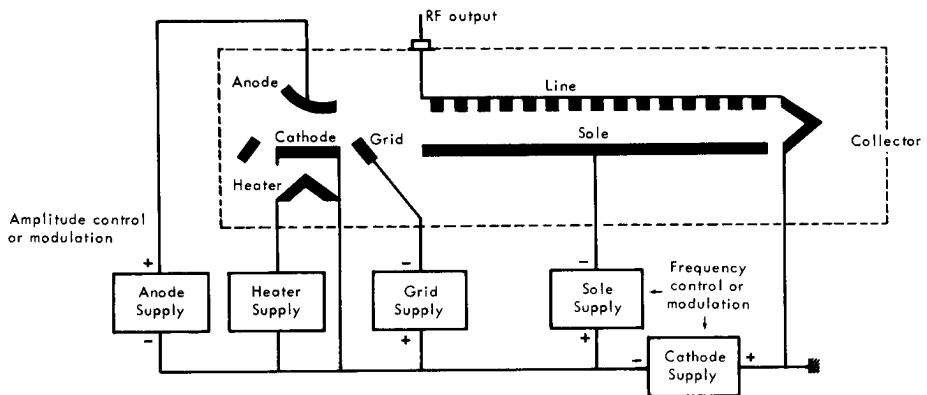



OUTLINE DRAWING

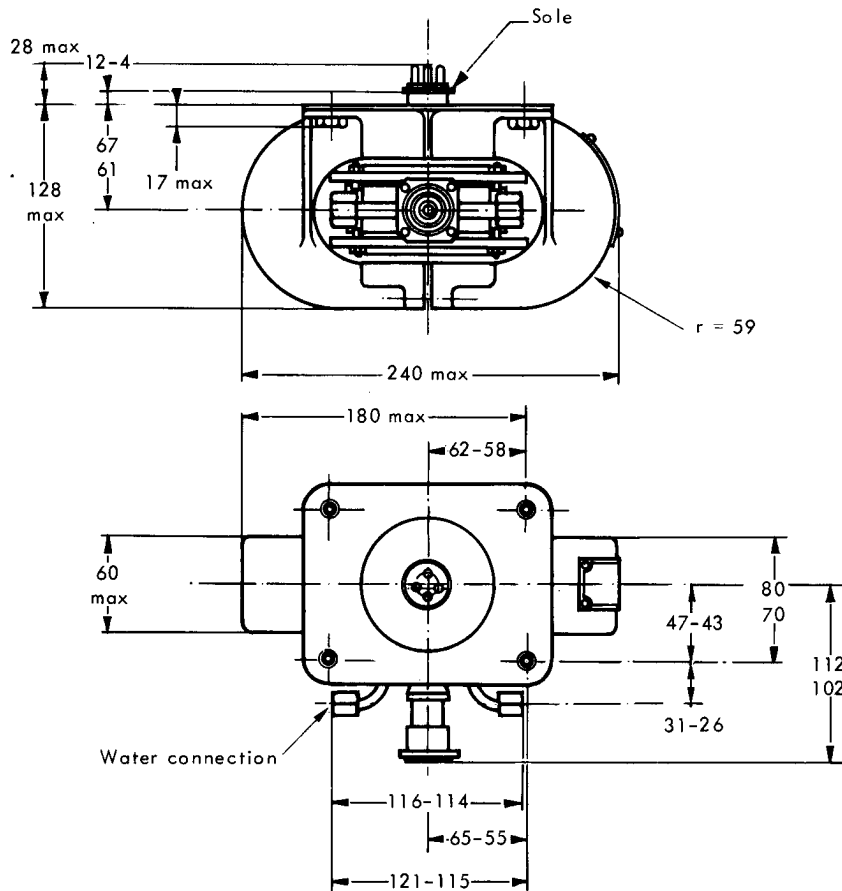

Pin arrangement

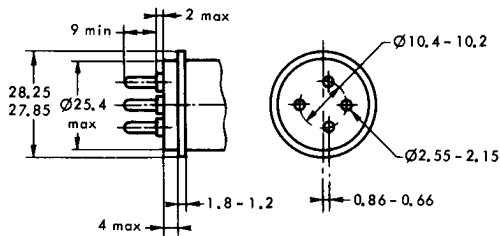

The pin position with respect to the tube axes is determined within 10°

Maximum base eccentricity with respect to the sole connection: 0.3 mm.

Mounting flange

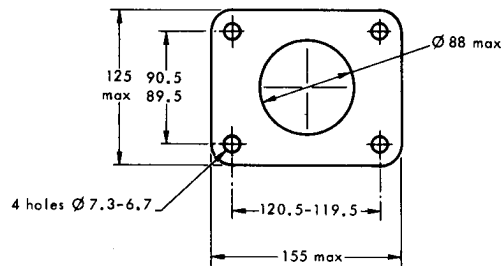

Water connection

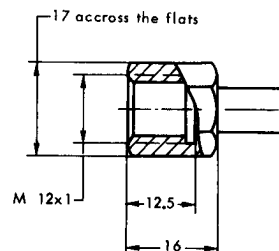

Dimensions in mm

