

TRIODE-PENTODE

DESCRIPTION AND RATING

The 10C8 is a miniature triode-pentode designed for use in compact, 300-milliampere, series-string television receivers. The pentode section may be used as a general-purpose amplifier or as a triode-connected vertical-deflection amplifier. The high-mu triode section is suitable for use as a vertical oscillator, AF voltage amplifier, or as a sync separator, clipper, or amplifier.

The 10C8 has a controlled heater warm-up characteristic as required for use in television receivers that employ series-connected heaters. Other features of the tube include relatively small size, low power requirements, and high performance capabilities at the low d-c supply voltages normally available in these applications.

GENERAL

ELECTRICAL

Cathode—Coated Unipotential

Heater Voltage, AC or DC.....	10.5 Volts
Heater Current.....	$0.3 \pm 6\%$ Amperes
Heater Warm-up Time*.....	11 Seconds

Direct Interelectrode Capacitances†

Pentode Section

Grid-Number 1 to Plate, maximum.....	0.04 μ f
Input.....	7.0 μ f
Output.....	2.2 μ f

Triode Section

Grid to Plate.....	1.6 μ f
Input.....	2.4 μ f
Output.....	0.20 μ f

Pentode Grid-Number 1 to Triode Plate, maximum.....	0.008 μ f
Triode Grid to Pentode Plate, maximum.....	0.006 μ f
Pentode Plate to Triode Plate, maximum.....	0.06 μ f

MECHANICAL

Mounting Position—Any

Envelope—T-6 1/2, Glass

Base—E9-1, Small Button 9-Pin

BASING DIAGRAM

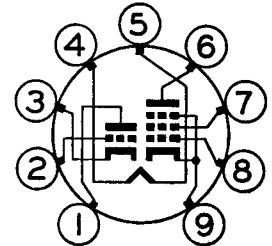

RETMA 9DA

TERMINAL CONNECTIONS

- Pin 1—Triode Plate
- Pin 2—Triode Grid
- Pin 3—Triode Cathode
- Pin 4—Heater
- Pin 5—Heater
- Pin 6—Pentode Plate
- Pin 7—Pentode Grid Number 2 (Screen)
- Pin 8—Pentode Grid Number 1
- Pin 9—Pentode Cathode, Grid Number 3, and Internal Shield

PHYSICAL DIMENSIONS

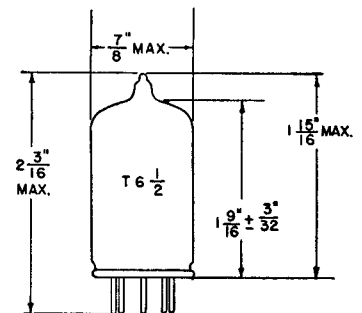

RETMA 6-2

MAXIMUM RATINGS

	Pentode Section	Triode Section
CLASS A₁ AMPLIFIER SERVICE—DESIGN-MAXIMUM VALUES		
Plate Voltage	300	300 Volts
Screen-Supply Voltage	300 Volts
Screen Voltage—See Screen Rating Chart		
Positive DC Grid-Number 1 Voltage	0	0 Volts
Plate Dissipation	2.2	2.0 Watts
Screen Dissipation	0.55 Watts
Heater-Cathode Voltage		
Heater Positive with Respect to Cathode		
DC Component	100	100 Volts
Total DC and Peak	200	200 Volts
Heater Negative with Respect to Cathode		
Total DC and Peak	200	200 Volts
Grid-Number 1 Circuit Resistance		
With Fixed Bias	0.25	0.5 Megohms
With Cathode Bias	1.0	1.0 Megohms
 VERTICAL OSCILLATOR AND AMPLIFIER SERVICE DESIGN-MAXIMUM VALUES		
	Vertical- deflection Amplifier † (Pentode Section- triode Con- nection §)	Vertical Oscillator Service ‡ (Triode Section)
DC Plate Voltage	300	300 Volts
Peak Positive Pulse Plate Voltage	1000 Volts
Peak Negative Grid Voltage	250	400 Volts
Plate Dissipation	2.5 †	1.0 Watts
DC Cathode Current	18	12 Milliampere
Peak Cathode Current	55	35 Milliampere
Heater-Cathode Voltage		
Heater Positive with Respect to Cathode		
DC Component	100	100 Volts
Total DC and Peak	200	200 Volts
Heater Negative with Respect to Cathode		
Total DC and Peak	200	200 Volts
Grid Circuit Resistance		
With Fixed Bias	2.2 Megohms
With Cathode Bias	2.2	2.2 Megohms
With Grid-Leak Bias	2.2	2.2 Megohms

Design-Maximum Ratings are the limiting values expressed with respect to bogie tubes at which satisfactory tube life can be expected to occur for the types of service for which the tube is rated. Therefore, the equipment designer must establish the circuit design so that initially and throughout equipment life no design-maximum value is exceeded with a bogie tube under the worst probable operating conditions with respect to supply-voltage variation, equipment component variation, equipment control adjustment, load variation, and environmental conditions.

CHARACTERISTICS AND TYPICAL OPERATION

AVERAGE CHARACTERISTICS

	Pentode Section (Triode- Connection§)	Pentode Section	Triode Section
Plate Voltage	135	135	250 Volts
Screen Voltage	135	... Volts
Grid-Number 1 Voltage	0¶ Volts
Cathode-Bias Resistor	100	390 Ohms
Amplification Factor	53
Plate Resistance, approximate	19000	12000 Ohms
Transconductance	8000	4400 Micromhos
Plate Current	33	11.5	7.3 Milliamperes
Screen Current	3.2	... Milliamperes
Grid-Number 1 Voltage, approximate			
I _b = 10 Microamperes	-10 Volts
I _b = 50 Microamperes	-6	... Volts
Triode Amplification Factor§	40	...

* The time required for the voltage across the heater to reach 80 percent of its rated value after applying 4 times rated heater voltage to a circuit consisting of the tube heater in series with a resistance equal to 3 times the rated heater voltage divided by the rated heater current.

† Without external shield.

‡ For operation in a 525-line, 30-frame television system as described in "Standards of Good Engineering Practice Concerning Television Broadcast Stations," Federal Communications Commission. The duty cycle of the voltage pulse must not exceed 15 percent of one scanning cycle.

§ With screen connected to plate.

♦ In stages operating with grid-leak bias, an adequate cathode-bias resistor or other suitable means is required to protect the tube in the absence of excitation.

¶ Applied for short interval (two seconds maximum) so as not to damage tube.

AVERAGE PLATE CHARACTERISTICS

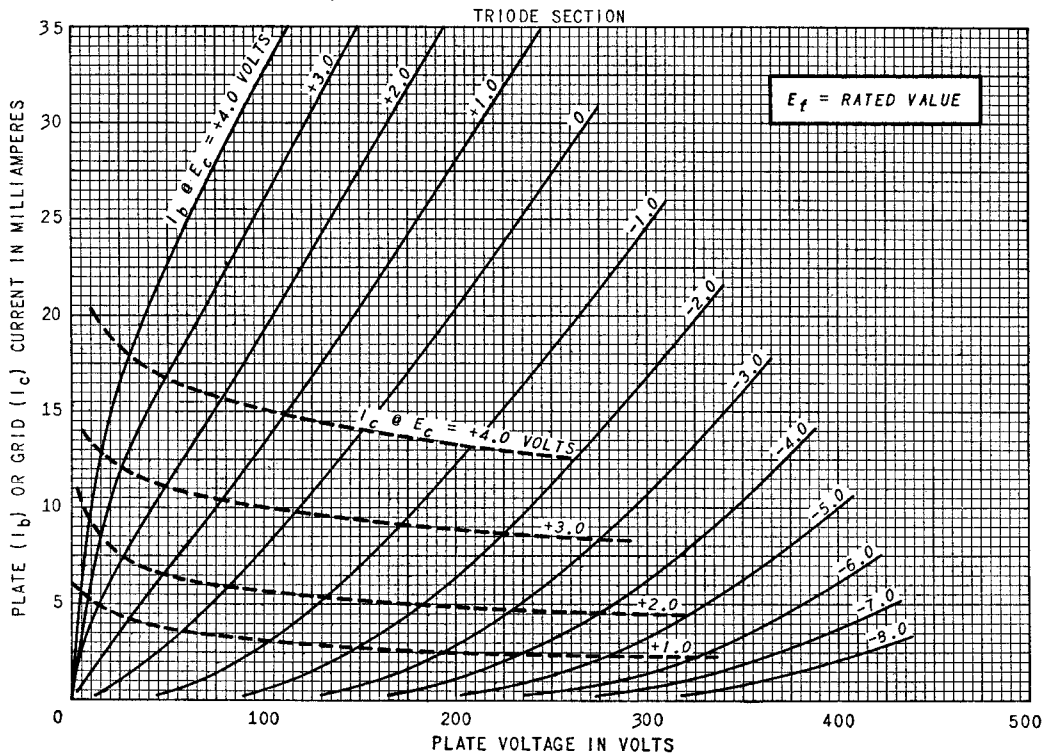

AVERAGE TRANSFER CHARACTERISTICS

TRIODE SECTION

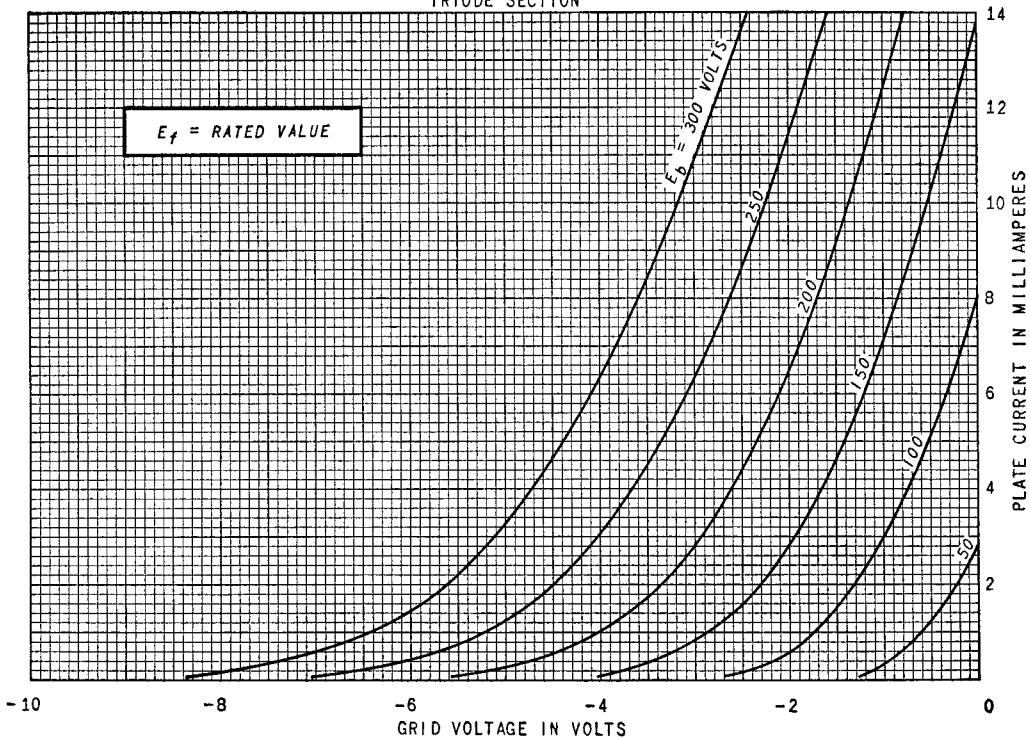

AVERAGE CHARACTERISTICS

TRIODE SECTION

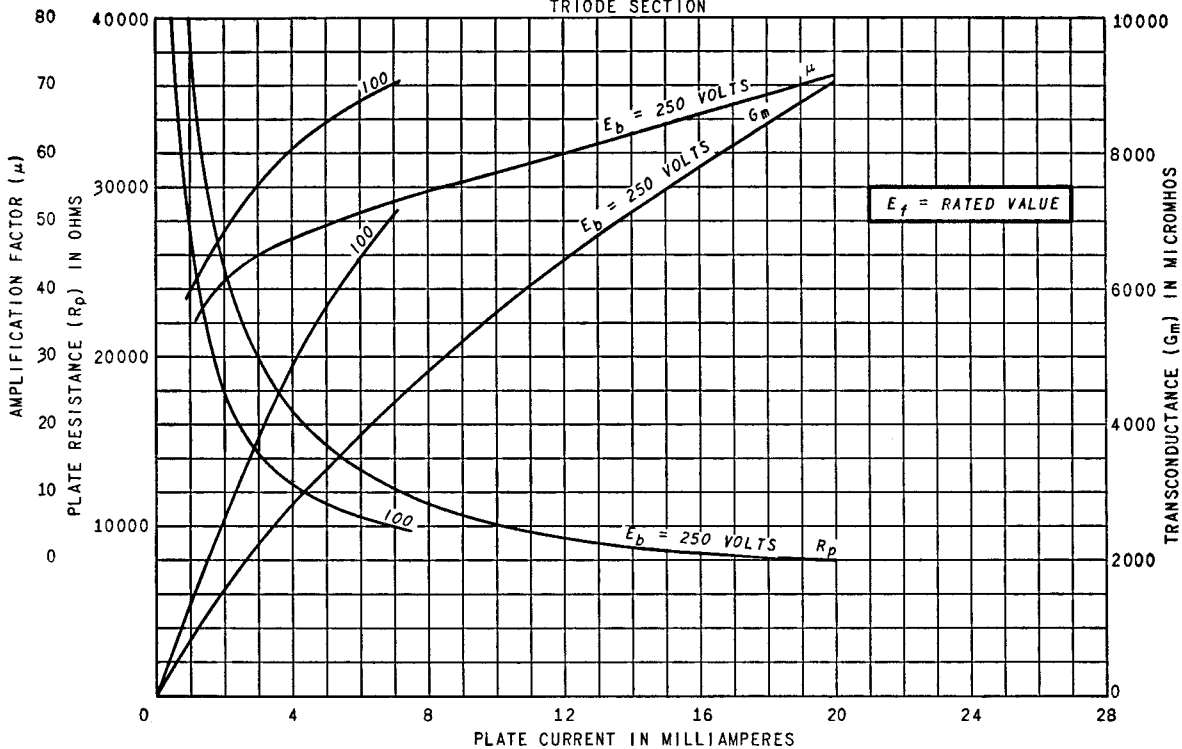

AVERAGE PLATE CHARACTERISTICS
 PENTODE SECTION - TRIODE CONNECTION

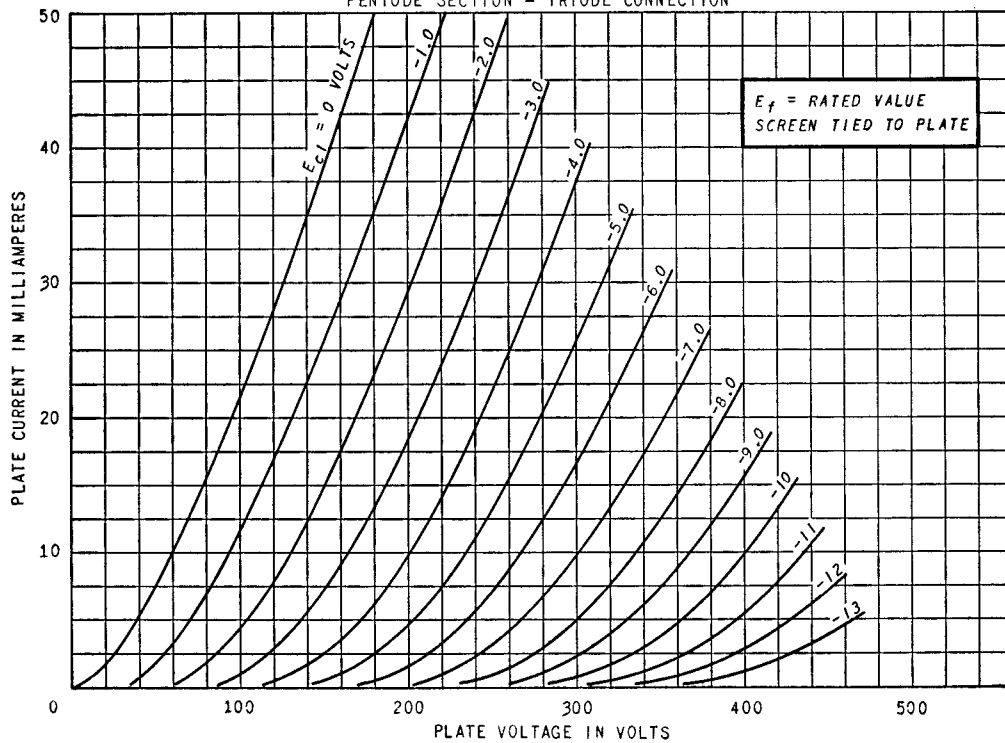

AVERAGE PLATE CHARACTERISTICS
 PENTODE SECTION

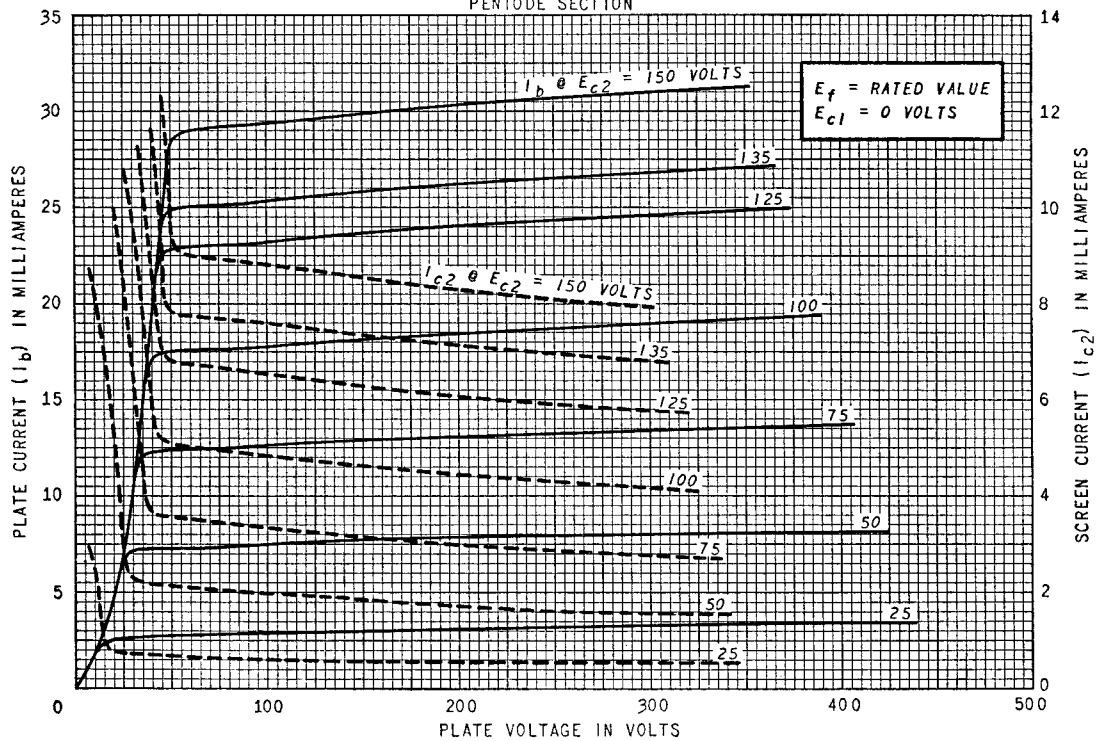

AVERAGE PLATE CHARACTERISTICS

PENTODE SECTION

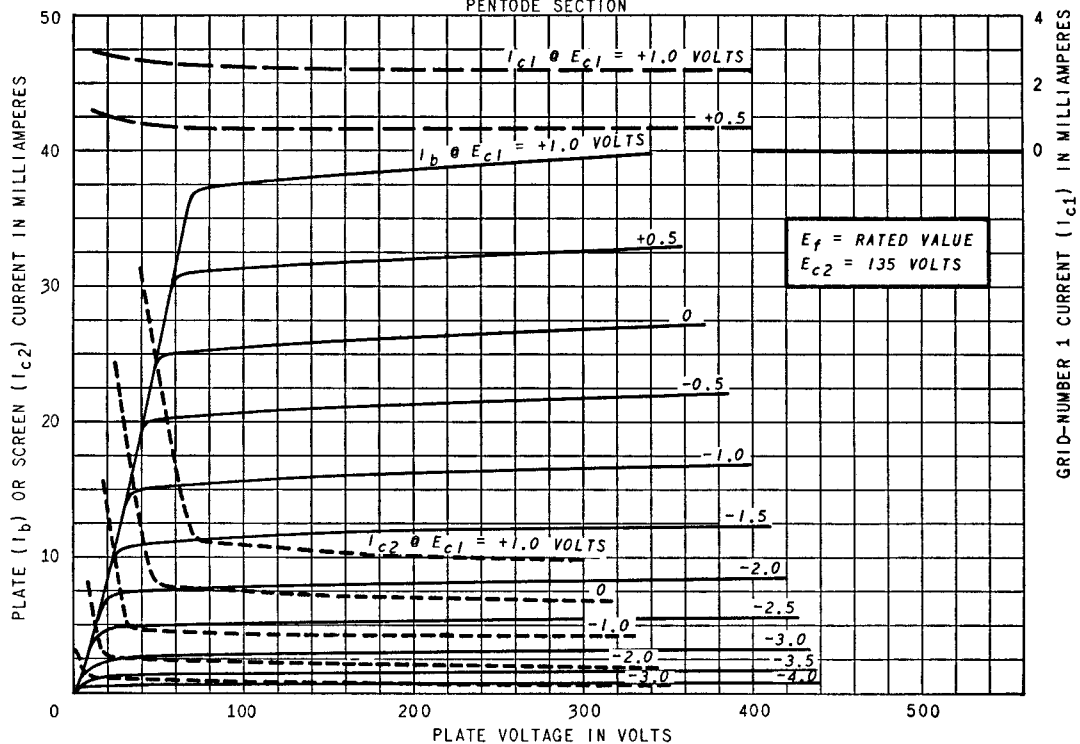

AVERAGE TRANSFER CHARACTERISTICS

PENTODE SECTION

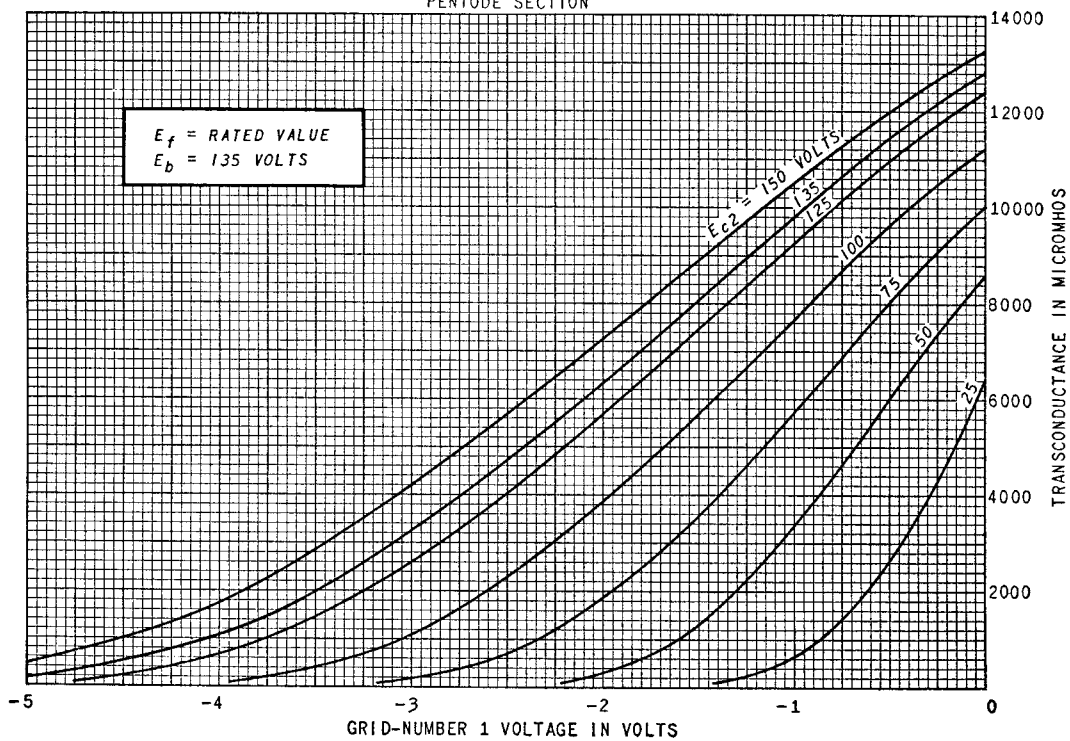

AVERAGE TRANSFER CHARACTERISTICS PENTODE SECTION

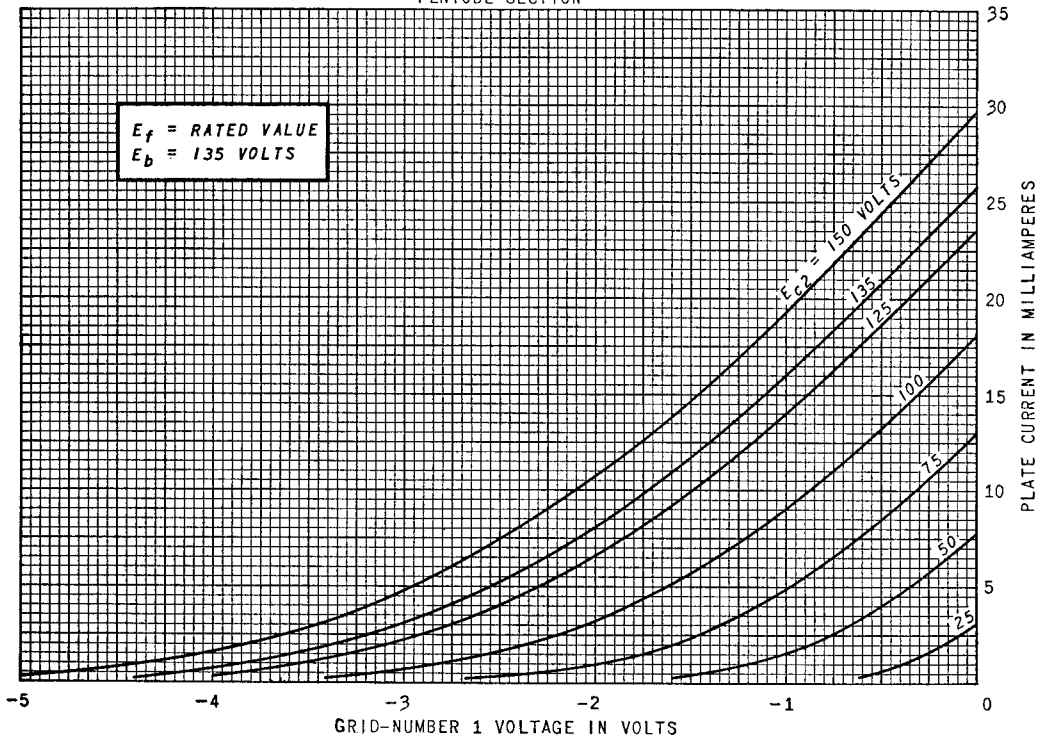

AVERAGE TRANSFER CHARACTERISTICS PENTODE SECTION

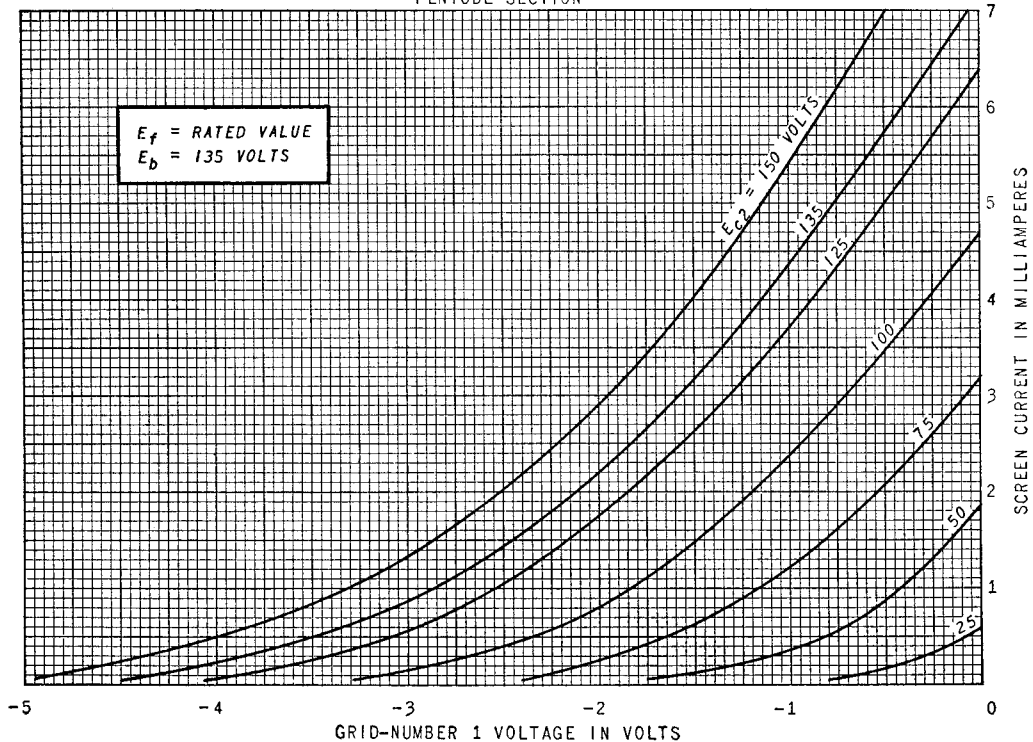

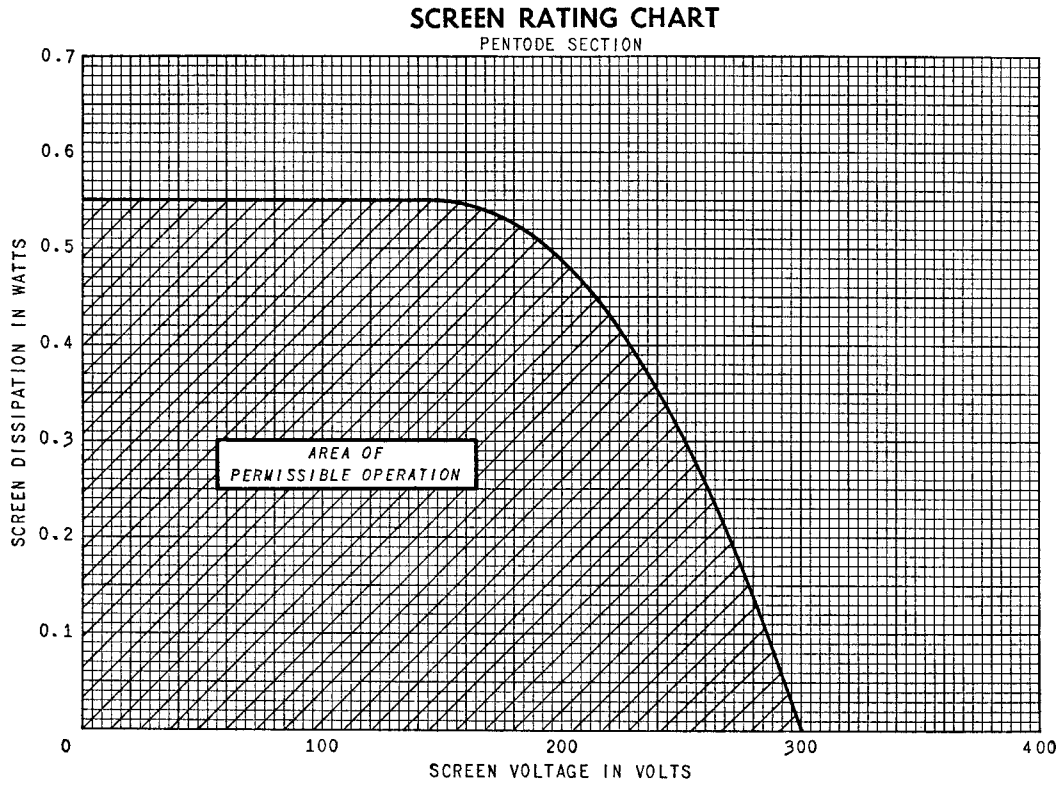

TUBE DEPARTMENT

GENERAL  ELECTRIC

Schenectady 5, N. Y.