

The Eimac 3X2500A3 is a medium-mu, forced-air-cooled, external-anode transmitting triode with a maximum plate-dissipation rating of 2500 watts. Relatively high power output as an amplifier, oscillator or modulator may be obtained from this tube at low plate voltages. A single tube will deliver a radio-frequency output of 7500 watts at 4000 plate volts at frequencies up to 110 Mc., as well as at lower frequencies.

The tube has a rugged, low-inductance cylindrical filament-stem structure, which readily becomes part of a linear filament tank circuit for V.H.F. operation. The grid provides thorough shielding between the input and output circuits for grounded-grid applications, and is conveniently terminated in a ring between the plate and filament terminals. As a result of the use of unique grid- and filament-terminal arrangements, it is possible to install or remove the 3X2500A3 without the aid of tools.

The approved Federal Communications Commission rating for the 3X2500A3 as a plate-modulated amplifier is 5000 watts of carrier power.

**GENERAL CHARACTERISTICS**

**ELECTRICAL**

Filament: Thoriated tungsten	
Voltage	7.5 volts
Current	51 amperes
Amplification Factor (Average)	20
Direct Interelectrode Capacitances (Average)	
Grid-Plate	20 $\mu$ fd
Grid-Filament	36 $\mu$ fd
Plate-Filament	1.2 $\mu$ fd
Transconductance ( $I_b=830$ ma., $E_b=3000$ v.)	20,000 $\mu$ hos
Highest Frequencies for Maximum Ratings	75 Mc

**MECHANICAL**

Base	see drawing
Mounting	Vertical, base down or up
Cooling	Forced air
Maximum Anode Cooler Core and Seal Temperatures	150°C
Maximum Over-All Dimensions:	
Length	9.0 inches
Diameter	4.156 inches
Net Weight	6.25 pounds
Shipping Weight (Average)	17 pounds



**RADIO-FREQUENCY POWER AMPLIFIER OR OSCILLATOR**

(Conventional Neutralized Amplifier—Frequencies below 75 Mc.)  
 Class-C FM or Telegraphy (Key-down conditions, per tube)

<b>MAXIMUM RATINGS</b>	
D-C PLATE VOLTAGE	6000 MAX. VOLTS
D-C PLATE CURRENT	2.5 MAX. AMPS
PLATE DISSIPATION	2500 MAX. WATTS
PLATE COOLER CORE TEMPERATURE	150 MAX. °C
GRID DISSIPATION*	150 MAX. WATTS

**TYPICAL OPERATION (Frequencies below 75 Mc., per tube)**

D-C Plate Voltage	4000	5000	6000	volts
D-C Plate Current	2.5	2.5	2.08	amps
D-C Grid Voltage	-450	-450	-500	volts
D-C Grid Current	245	265	180	ma
Peak R-F Grid Input Voltage	580	750	765	volts
Driving Power (approx.)	142	197	136	watts
Grid Dissipation	68	78	46	watts
Plate Power Input	10,000	12,500	12,500	watts
Plate Dissipation	2500	2500	2500	watts
Plate Power Output	7500	10,000	10,000	watts

**RADIO-FREQUENCY POWER AMPLIFIER**

Grounded-Grid Circuit  
 Class-C FM Telephony

<b>MAXIMUM RATINGS (Frequencies between 85 and 110 Mc.)</b>	
D-C PLATE VOLTAGE	4000 MAX. VOLTS
D-C PLATE CURRENT	2.0 MAX. AMPS
D-C GRID CURRENT*	200 MAX. MA
PLATE DISSIPATION	2500 MAX. WATTS
PLATE COOLER CORE TEMPERATURE	150 MAX. °C
GRID DISSIPATION*	150 MAX. WATTS

**TYPICAL OPERATION (110 Mc., per tube)**

D-C Plate Voltage	3700	4000	volts
D-C Grid Voltage	-450	-500	volts
D-C Plate Current	1.8	1.85	amps
D-C Grid Current	190	190	ma
Driving Power (approx.)	1600	1900	watts
Useful Power Output	6850	7500	watts

**PLATE-MODULATED RADIO-FREQUENCY AMPLIFIER**

(Conventional Neutralized Amplifier—Frequencies below 75 Mc.)  
 Class-C Telephony (Carrier conditions, per tube)

<b>MAXIMUM RATINGS</b>	
D-C PLATE VOLTAGE	5000 MAX. VOLTS
D-C PLATE CURRENT	2.0 MAX. AMPS
PLATE DISSIPATION	1670 MAX. WATTS
PLATE COOLER CORE TEMPERATURE	150 MAX. °C
GRID DISSIPATION	150 MAX. WATTS

**TYPICAL OPERATIONS (Frequencies below 75 Mc., per tube)**

D-C Plate Voltage	4000	4500	5000	volts
D-C Plate Current	1.67	1.55	1.45	amps
Total Bias Voltage	-450	-500	-550	volts
Fixed Bias Voltage	-230	-325	-410	volts
Grid Resistor	1500	1500	1400	ohms
D-C Grid Current	150	120	100	ma
Peak R-F Grid Input Voltage	680	720	760	volts
Driving Power (approx.)	102	86	76	watts
Grid Dissipation	35	26	21	watts
Plate Power Input	6670	6970	7250	watts
Plate Dissipation	1670	1670	1670	watts
Plate Power Output	5000	5300	5580	watts

IF IT IS DESIRED TO OPERATE THIS TUBE UNDER CONDITIONS WIDELY DIFFERENT FROM THOSE GIVEN UNDER "TYPICAL OPERATION", POSSIBLY EXCEEDING THE MAXIMUM RATINGS GIVEN FOR CW SERVICE, WRITE EITEL-McCULLOUGH, INC., FOR INFORMATION AND RECOMMENDATIONS.

## AUDIO-FREQUENCY POWER AMPLIFIER AND MODULATOR

Class B (Sinusoidal wave, two tubes unless otherwise specified)

MAXIMUM RATINGS	
D-C PLATE VOLTAGE	6000 MAX. VOLTS
MAX.-SIGNAL D-C PLATE CURRENT, PER TUBE	2.5 MAX. AMPS
PLATE DISSIPATION, PER TUBE	2500 MAX. WATTS
PLATE COOLER CORE TEMPERATURE	150 MAX. ° C

TYPICAL OPERATION CLASS AB <sub>2</sub> (Two tubes)			
D-C Plate Voltage	4000	5000	6000 volts
D-C Grid Voltage (approx.)*	-150	-190	-240 volts
Zero-Signal D-C Plate Current	0.6	0.5	0.4 amps
Max.-Signal D-C Plate Current	4.0	3.2	3.0 amps
Effective Load, Plate to Plate	2200	3600	4650 ohms
Peak A-F Grid Input Voltage (per tube)	340	360	390 volts
Max.-Signal Peak Driving Power	340	230	225 watts
Max.-Signal Nominal Driving Power (approx.)	170	115	113 watts
Max.-Signal Plate Power Output	11,000	11,000	13,000 watts

### TYPICAL OPERATION CLASS AB<sub>2</sub> (Two tubes)

(Modulator service for 4000 and 5000 volt operation, to modulate one or two tubes, as shown under "Plate Modulated Radio Frequency Amplifier.")

D-C Plate Voltage	4000	5000	4000	5000	volts
D-C Grid Voltage (approx.)*	-155	-200	-145	-190	volts
Zero-Signal D-C Plate Current	0.4	0.4	0.6	0.5	amps
Max.-Signal D-C Plate Current	1.35	1.13	2.70	2.26	amps
Effective Load, Plate to Plate	6600	10,000	3300	5000	ohms
Peak A-F Grid Input Voltage (per tube)	240	275	285	310	volts
Max-Signal Peak Driving Power	42	40	134	118	watts
Max.-Signal Nominal Driving Power (approx.)	21	20	67	59	watts
Max.-Signal Plate Power Output	3700	4000	7400	8000	watts
Will Modulate R. F. Final Input of	6670	7250	13,340	14,500	watts

\*Adjust to give stated zero-signal plate current.

## APPLICATION

► **Cooling**—A minimum air flow of 120 cubic feet per minute must be passed through the anode cooler. The pressure drop across the cooler at this rate of flow equals 1.0 inch of water when the tube is cold, and increases with rising temperature to 1.25 inches when the plate dissipation attains its rated maximum value of 2500 watts.

A minimum air flow of 6 cubic feet per minute must also be directed into the filament stem structure between the inner and outer filament terminals. Cooling air in the above quantities must be supplied to the anode cooler and the filament seals before filament voltage is applied, and the air flow should be maintained for at least one minute after the filament power has been removed. Simultaneous removal of all power and air (as in case of power failure) will not ordinarily injure the tube, but it is not recommended as a standard operating practice. Anode-cooler-core, grid- and filament-seal temperatures must not exceed 150° C.

The figures above are for an ambient temperature of 20° C at sea level and do not include duct or filter losses. Further information regarding operation at higher ambient temperatures or higher altitudes is available in an article entitled "Blower Selection for Forced Air Cooled Tubes", by A. G. Nekat, in the August, 1950, issue of "Electronics".

► **Filament Voltage**—The filament voltage, as measured directly at the tube, should be 7.5 volts with maximum allowable variations due to line fluctuation of from 7.12 to 7.87 volts.

► **Bias Voltage**—There is little advantage in using bias voltages in excess of those given under "Typical Operation", except in certain very specialized applications. Where bias is obtained from a grid resistor, suitable protective means must be provided to prevent excessive plate dissipation in the event of loss of excitation.

► **Plate Voltage**—The plate-supply voltage for the 3X2500A3 should not exceed 6000 volts. In most cases there is little advantage in using plate-supply voltages higher than those given under "Typical Operation" for the power output desired.

In Class-C FM or Telegraphy service, a 0.1 henry choke, shunted by a spark gap, should be series connected between the plates of the amplifier tubes and the high-voltage-plate-supply capacitor to offer protection from transients and surges. In plate-modulated service, where a plate-modulation transformer is used, the protective choke is not normally required.

► **Grid Dissipation**—The power dissipated by the grid of the 3X2500A3 must never exceed 150 watts. Grid dissipation may be calculated from the following expression:

$$P_g = e_{cmp} I_c$$

where  $P_g$  = Grid dissipation,  
 $e_{cmp}$  = Peak positive grid voltage, and  
 $I_c$  = D-c grid current.

$e_{cmp}$  may be measured by means of a suitable peak voltmeter connected between filament and grid. Any suitable peak v.t.v.m. circuit may be used (one is shown in "Vacuum Tube Ratings", Eimac News, January 1945. This article is available, in reprint form on request).

In equipment in which the plate loading varies widely, such as oscillators used for radio-frequency heating, care should be taken to make certain that the grid dissipation does not exceed the maximum rating under any condition of loading.

In VHF operation, particularly above 75 Mc., the d-c grid current must not exceed 200 ma. under any conditions of plate loading. With lightly loaded conditions the grid driving power should be reduced so that the grid current does not exceed one-tenth of the plate current.

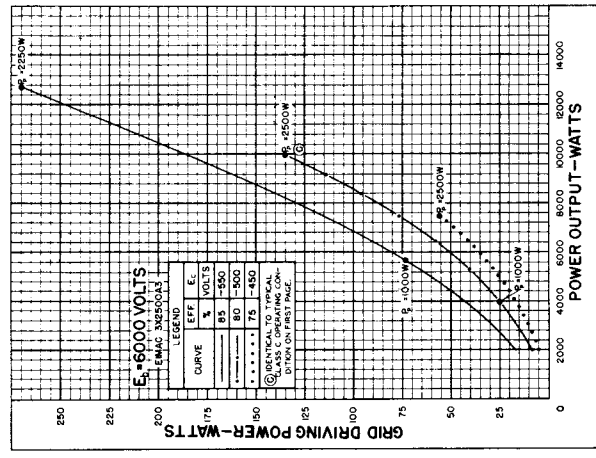
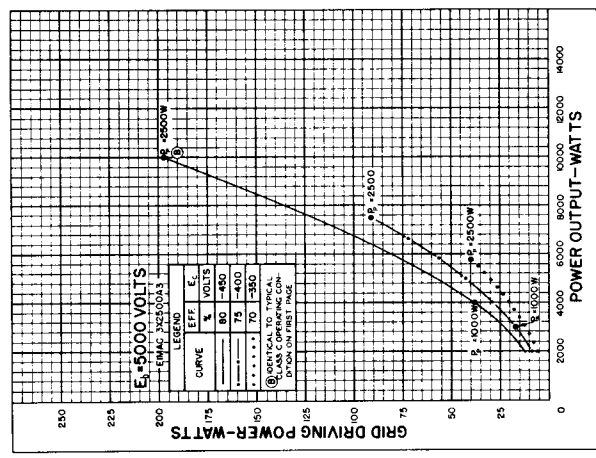
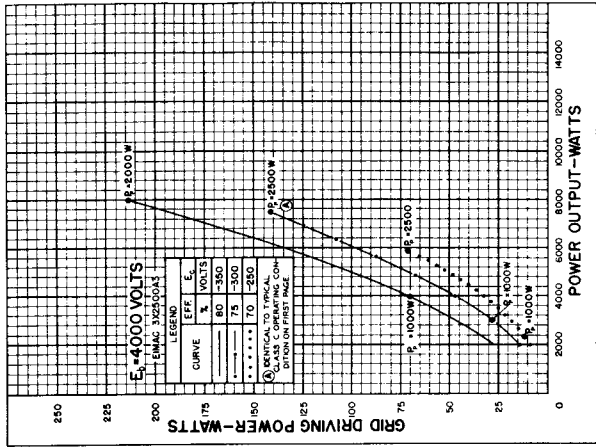

## DRIVING POWER vs. POWER OUTPUT

The three charts on this page show the relationship of plate efficiency, power output and approximate grid driving power at plate voltages of 4000, 5000 and 6000 volts. These charts show combined grid and bias losses only. The driving-power and power-output figures do not include circuit losses. The plate dissipation in watts is indicated by Pp. Points A, B, and C are identical to the typical Class C operating conditions shown on the first page under 4000, 5000 and 6000 volts respectively.

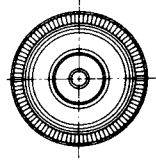
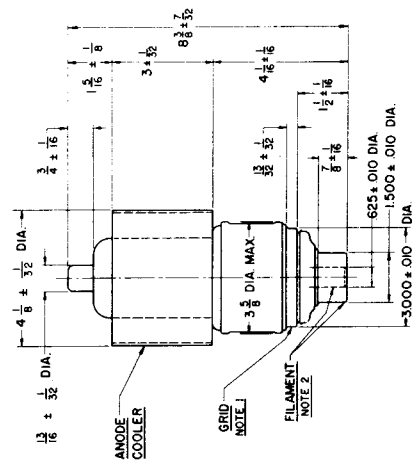
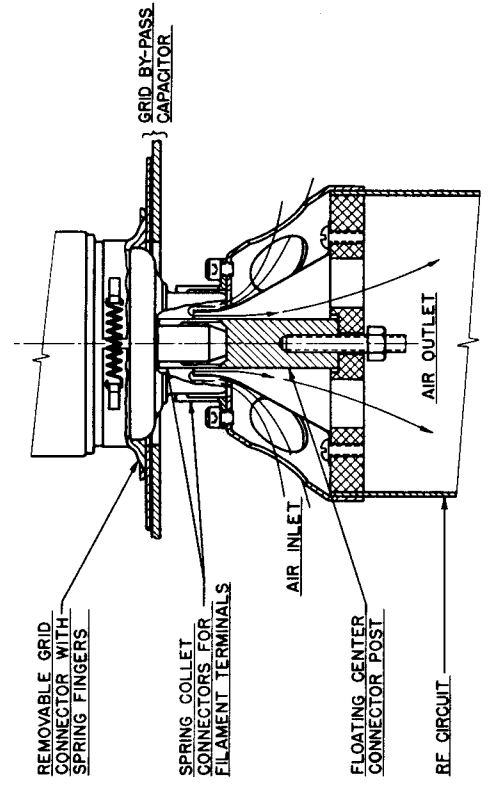

NOTE 1  
SEE MAXIMUM RUNOUT OF GRID CONTACT SURFACE WITH RESPECT TO AXIS DETERMINED BY ANODE AND OUTER FILAMENT CONTACT SURFACE.

NOTE 2  
SEE MAXIMUM RUNOUT OF INNER FILAMENT CONTACT SURFACE WITH RESPECT TO CENTER OF FILAMENT CONTACT SURFACE.

BOTTOM VIEW

TYPICAL TUBE CONNECTORS AND STEM COOLING.

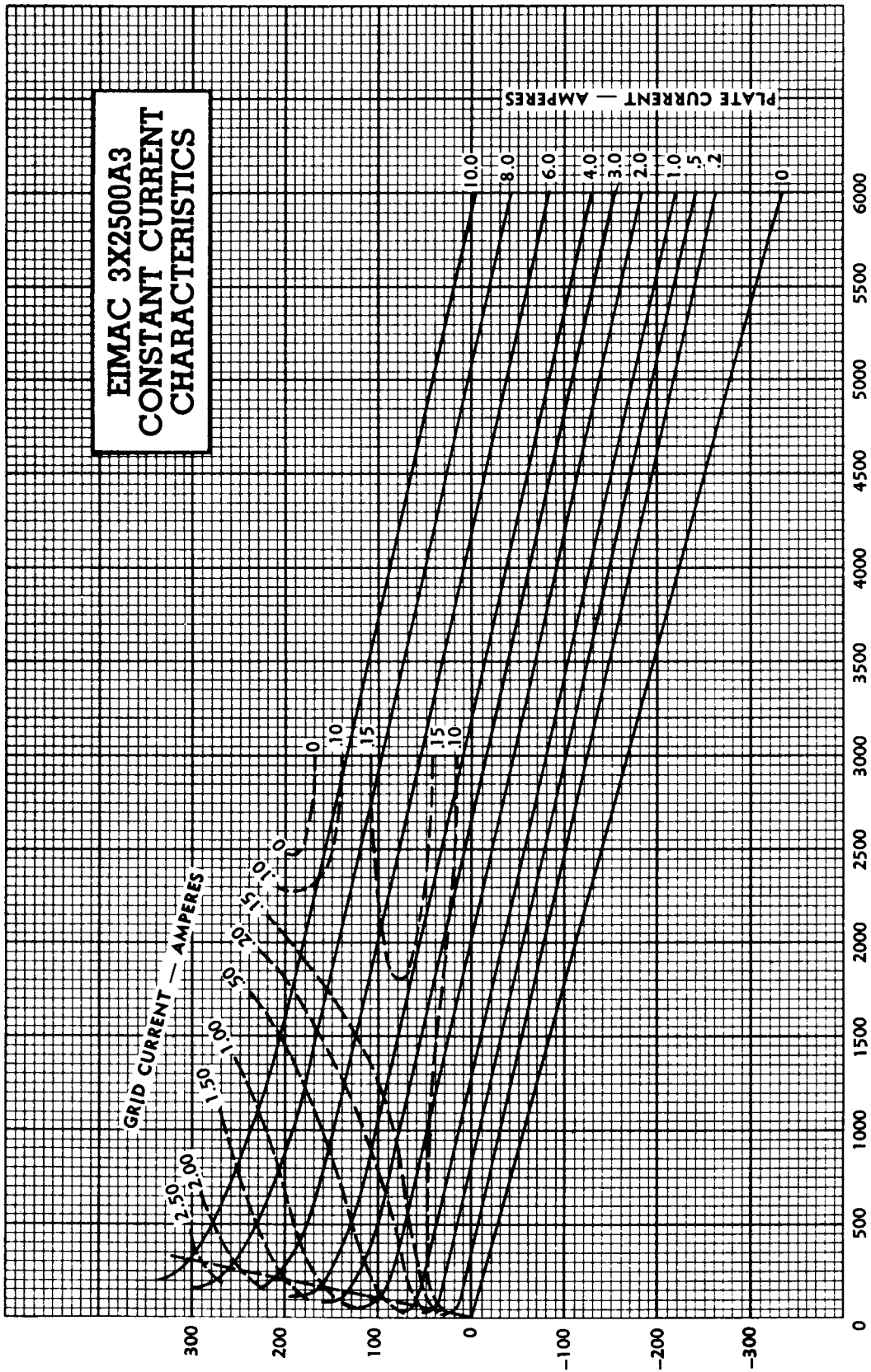

PLATE VOLTAGE - VOLTS

GRID VOLTAGE - VOLTS