



**TRIODE  
AUDIO-FREQUENCY AMPLIFIER**

*Western Electric*

**DESCRIPTION**

The 101L is a filamentary type triode. It is designed for use as an audio-frequency amplifier or modulator.

**CHARACTERISTICS**

Filament Current . . . . .	250 milliamperes
Maximum Plate Voltage . . . . .	180 volts
Amplification Factor . . . . .	6.5

**GENERAL CHARACTERISTICS****ELECTRICAL DATA**

Filament Current . . . . .	250 milliamperes
Filament Voltage, Nominal* . . . . .	4.15 volts
Direct Interelectrode Capacitances . . . . .	without external shield
Grid to Plate . . . . .	6.0 uuf
Input . . . . .	3.9 uuf
Output . . . . .	2.8 uuf

**MECHANICAL DATA**

Cathode . . . . .	Coated Filament
Base . . . . .	Medium 4-pin type with bayonet pin
Mounting Position . . . . .	Preferably vertical; if horizontal, pins #1 and #2 must lie in same vertical plane

Dimensions and pin connections shown in outline drawing on Page 5

**MAXIMUM RATINGS, Design-Center Values**

Plate Voltage . . . . .	180 volts
Plate Dissipation . . . . .	2.0 watts
Plate Current . . . . .	15 milliamperes

**TYPICAL OPERATING CONDITIONS AND CHARACTERISTICS — CLASS A<sub>1</sub> AMPLIFIER**

Filament Current, D-C . . . . .	250	250 milliamperes
Plate Voltage . . . . .	130	160 volts
Grid Voltage . . . . .	-8	-10 volts
Peak A-F Grid Voltage . . . . .	8	10 volts
Plate Current . . . . .	6.8	10.2 milliamperes
Transconductance . . . . .	1080	1240 micromhos
Amplification Factor . . . . .	6.5	6.5
Plate Resistance . . . . .	6000	5200 ohms
Load Resistance . . . . .	6000	5200 ohms
Maximum Signal Power Output . . . . .	60	100 milliwatts
Total Harmonic Distortion Less Than . . . . .	3.4	3.2 per cent

\* The filament resistance of this tube increases slightly during the first year of operating life. The voltage given above is the nominal value after the filament resistance has stabilized.

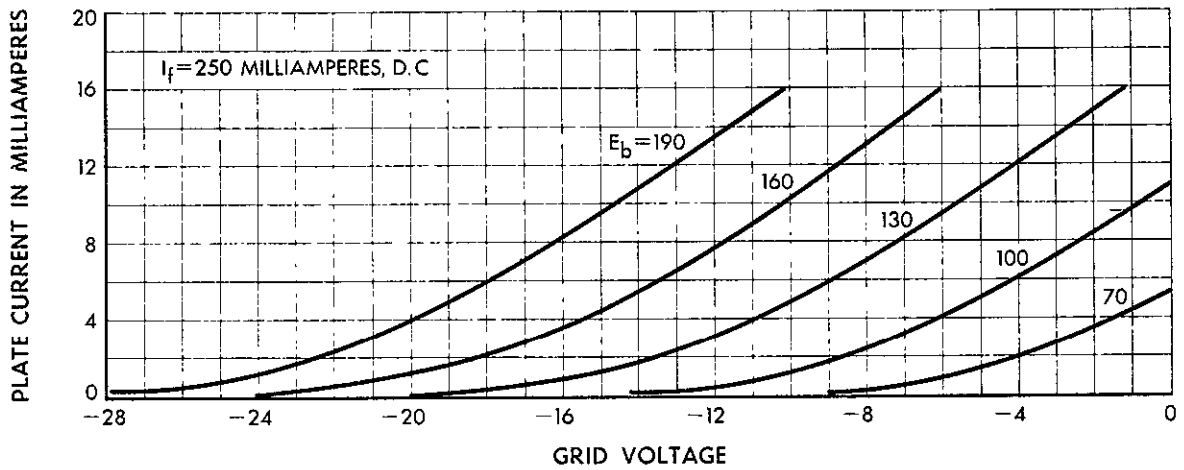
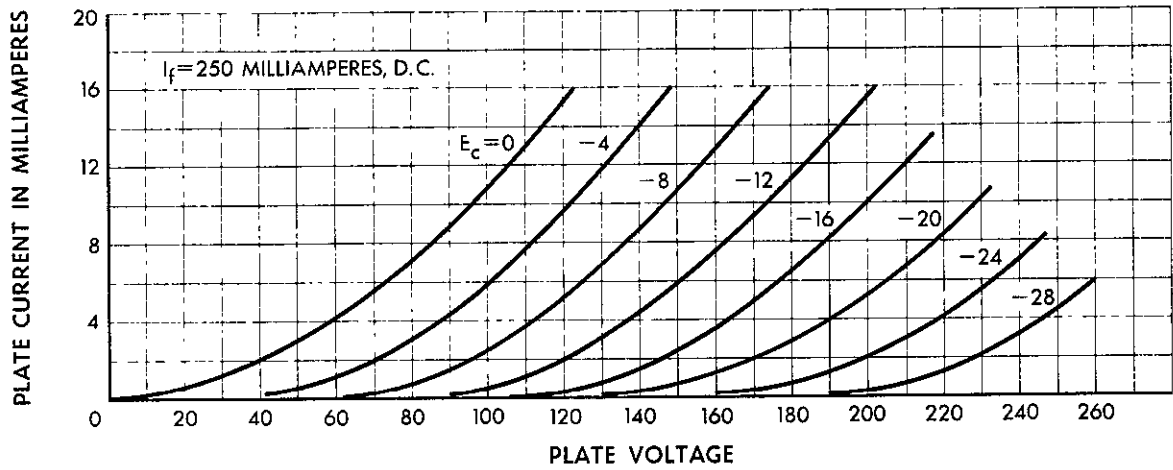

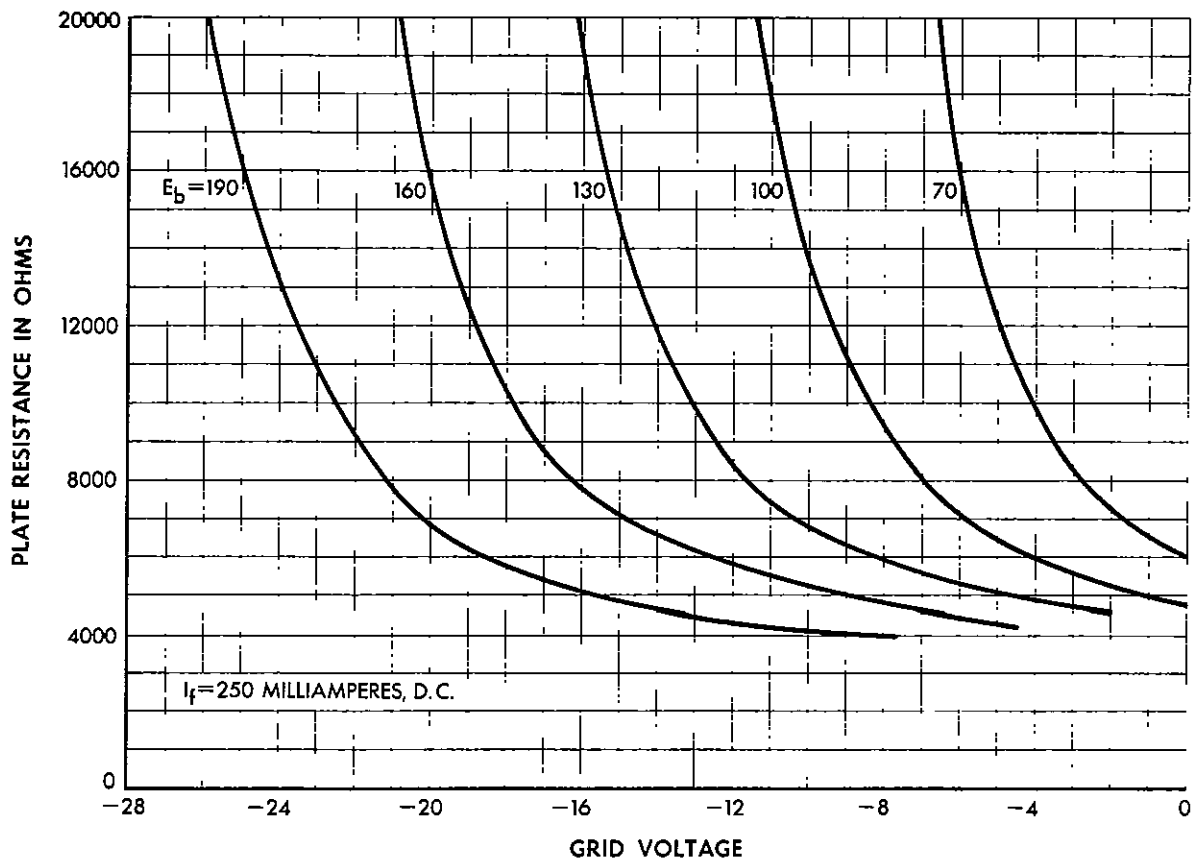
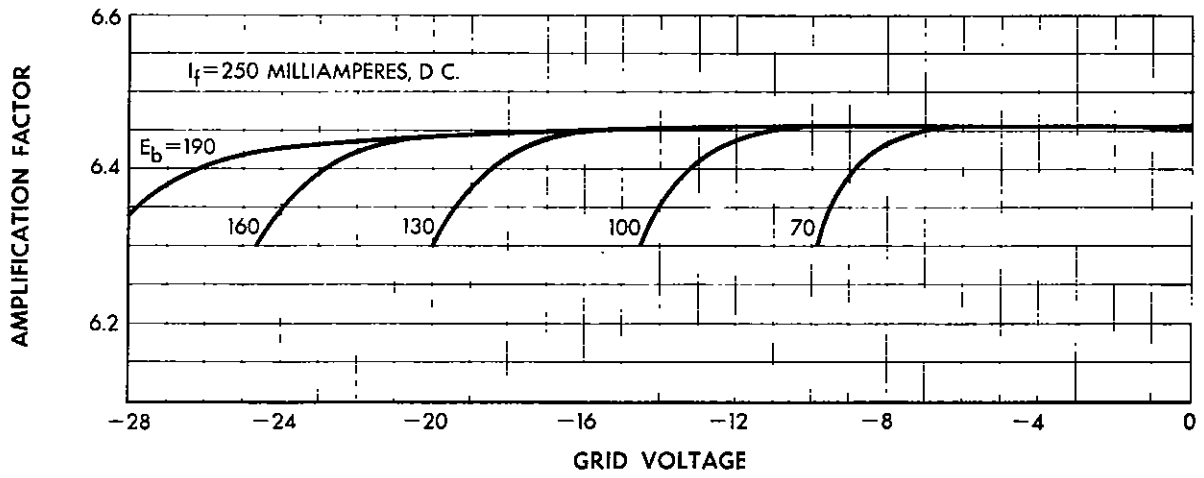

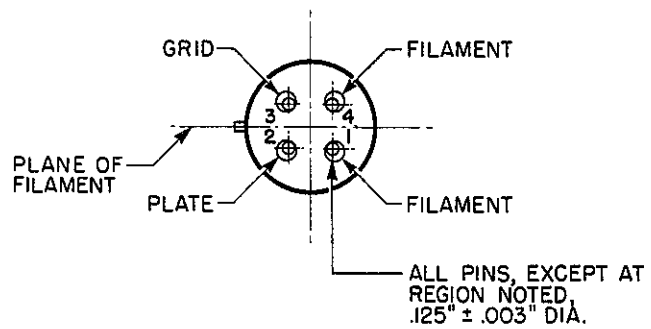
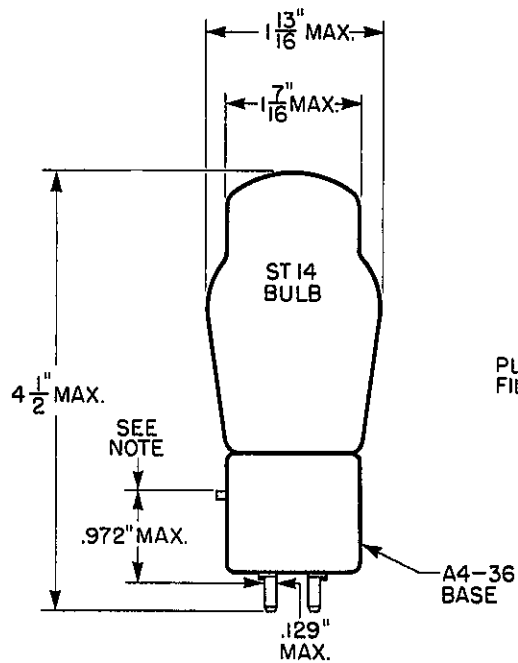
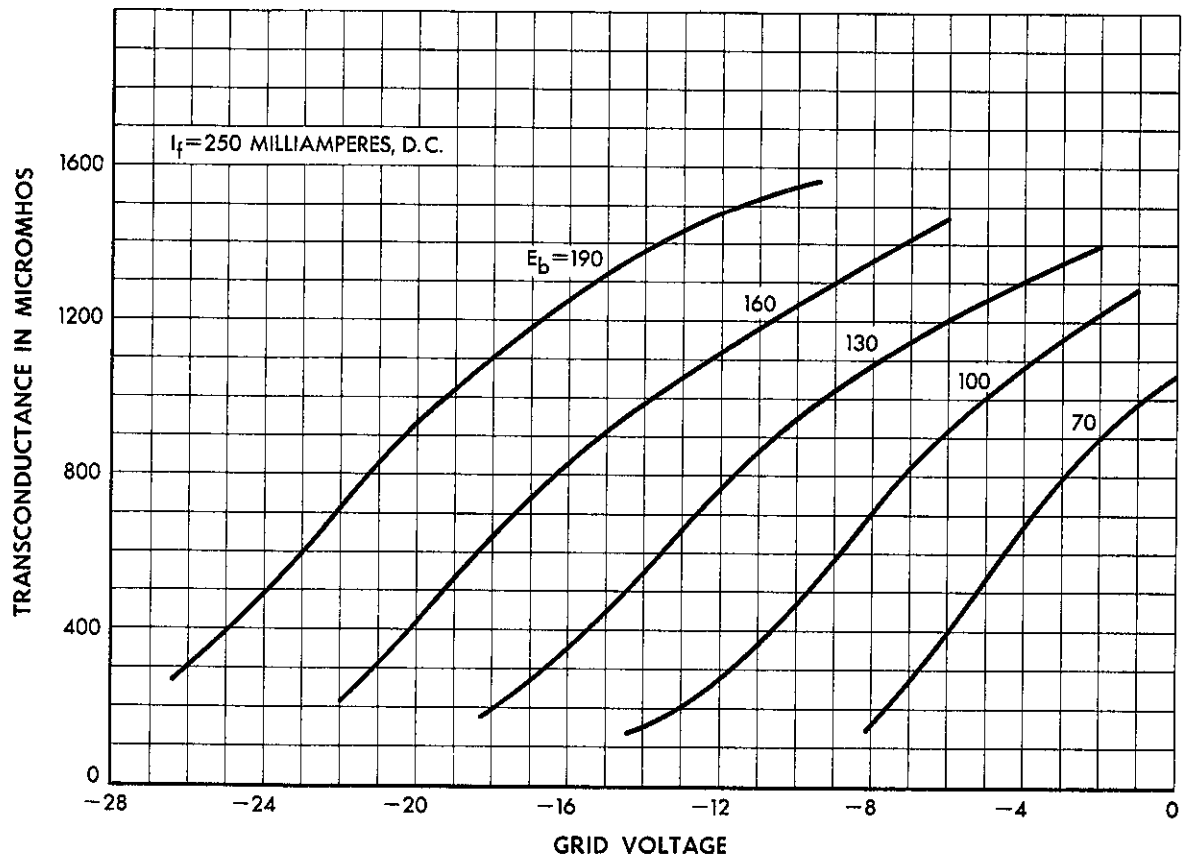

NOTE:  
THIS DIMENSION APPLIES FROM THE TOP OF THE BAYONET PIN, TO A POINT ON THE STUD WHERE THE DIAMETER OF THE STUD PLUS SOLDER DOES NOT EXCEED  $.129$  MAX.

*Western Electric*

A development of Bell Telephone Laboratories, the research laboratories of the American Telephone and Telegraph Company and the Western Electric Company.