

**TECHNICAL SERIES RC-24**

**\$1.25**  
**SUGGESTED**  
**PRICE**

# **RCA**

# **RECEIVING TUBE**

# **MANUAL**



**RADIO CORPORATION OF AMERICA**

**ELECTRONIC COMPONENTS AND DEVICES**  
**HARRISON, NEW JERSEY**

# Contents

	PAGE
<b>ELECTRONS, ELECTRODES, AND ELECTRON TUBES . . . . .</b>	<b>3</b>
Electrons, Cathodes, Generic Tube Types, Diodes, Triodes, Tetrodes, Pentodes, Beam Power Tubes, Multi-Electrode and Multi-Unit Types, Receiving Tube Structure, Television Picture Tubes	
<b>ELECTRON TUBE CHARACTERISTICS . . . . .</b>	<b>13</b>
<b>ELECTRON TUBE APPLICATIONS . . . . .</b>	<b>15</b>
Amplification, Rectification, Detection, Automatic Volume or Gain Control, Tuning Indication with Electron-Ray Tubes, Oscillation, Deflection Circuits, Frequency Conversion, Automatic Frequency Control	
<b>ELECTRON TUBE INSTALLATION . . . . .</b>	<b>67</b>
Filament and Heater Power Supply, Heater-to-Cathode Connection, Plate Voltage Supply, Grid Voltage Supply, Screen-Grid Voltage Supply, Shielding, Dress of Circuit Leads, Filters, Output-Coupling Devices, High-Fidelity Systems, High-Voltage Considerations for Television Picture Tubes, Picture-Tube Safety Considerations	
<b>INTERPRETATION OF TUBE DATA . . . . .</b>	<b>79</b>
<b>APPLICATION GUIDE FOR RCA RECEIVING TUBES . . . . .</b>	<b>85</b>
<b>TECHNICAL DATA FOR RCA TUBE TYPES . . . . .</b>	<b>94</b>
<b>PICTURE-TUBE CHARACTERISTICS CHART . . . . .</b>	<b>494</b>
<b>RCA VOLTAGE-REGULATOR AND VOLTAGE-REFERENCE TUBES . . . . .</b>	<b>499</b>
<b>ELECTRON TUBE TESTING . . . . .</b>	<b>500</b>
<b>RESISTANCE-COUPLED AMPLIFIERS . . . . .</b>	<b>504</b>
<b>OUTLINES . . . . .</b>	<b>513</b>
<b>CIRCUITS . . . . .</b>	<b>519</b>
<b>INDEX TO RCA RECEIVING TUBES . . . . .</b>	<b>561</b>
<b>INDEX . . . . .</b>	<b>568</b>

Information furnished by RCA is believed to be accurate and reliable. However, no responsibility is assumed by RCA for its use; nor for any infringements of patents or other rights of third parties which may result from its use. No license is granted by implication or otherwise under any patent or patent rights of RCA.

Copyright 1965 by Radio Corporation of America (All Rights Reserved)



Trade Mark(s) Registered  
Marca(s) Registrada(s)

10-65  
Printed in U.S.A.

# RCA

## Receiving Tube Manual

**THIS MANUAL**, like its preceding editions, has been prepared to assist those who work or experiment with home-entertainment-type electron tubes and circuits. It will be found valuable by engineers, service technicians, educators, experimenters, radio amateurs, hobbyists, students, and many others technically interested in electron tubes.

This up-dated edition features an all-inclusive **Index to RCA Receiving Tubes**, a comprehensive listing which will greatly facilitate the location of specific tube types in the manual. In addition, for more convenient referencing of latest tube types, the Technical Data Section has been restricted to coverage of active RCA types; basic data for replacement and discontinued RCA tubes are given in the **RCA Types for Replacement Use** table.

**RADIO CORPORATION OF AMERICA**  
ELECTRONIC COMPONENTS AND DEVICES                      HARRISON, N. J.

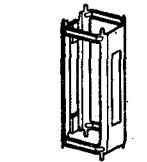

BEAM-  
CONFINING ELECTRODE

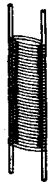

GRID  
NO. 2



GRID  
NO. 1  
(FRAME  
GRID  
CON-  
STRUCTION)



INSULATING  
SPACER

PLATE

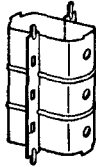

GRID  
RADIATOR



INSULATING  
SPACER

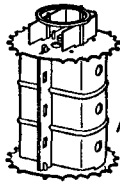

CAGE  
ASSEMBLY

HEATER



GETTER  
AND SUPPORT

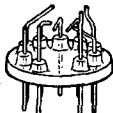

BUTTON  
STEM  
ASSEMBLY

CATHODE



BOTTOM-EXHAUST  
TYPE

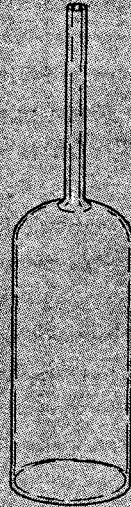

GLASS  
ENVELOPE



## Parts of a Typical Receiving Tube



# Electrons, Electrodes and Electron Tubes

**T**HE electron tube is a marvelous device. It makes possible the performing of operations, amazing in conception, with a precision and a certainty that are astounding. It is an exceedingly sensitive and accurate instrument—the product of coordinated efforts of engineers and craftsmen. Its construction requires materials from every corner of the earth. Its use is world-wide. Its future possibilities, even in the light of present-day accomplishments, are but dimly foreseen, for each development opens new fields of design and application.

The importance of the electron tube lies in its ability to control almost instantly the flight of the millions of electrons supplied by the cathode. It accomplishes this control with a minimum of energy. Because it is almost instantaneous in its action, the electron tube can operate efficiently and accurately at electrical frequencies much higher than those attainable with rotating machines.

## Electrons

All matter exists in the solid, liquid, or gaseous state. These three forms consist entirely of minute divisions known as molecules, which, in turn, are composed of atoms. Atoms have a nucleus which is a positive charge of electricity, around which revolve tiny charges of negative electricity known as **electrons**. Scientists have estimated that electrons weigh only 1/30-billion, billion, billion, billionths of an ounce, and that they may travel at speeds of thousands of miles per second.

Electron movement may be accelerated by the addition of energy. Heat is

one form of energy which can be conveniently used to speed up the electron. For example, if the temperature of a metal is gradually raised, the electrons in the metal gain velocity. When the metal becomes hot enough, some electrons may acquire sufficient speed to break away from the surface of the metal. This action, which is accelerated when the metal is heated in a vacuum, is utilized in most electron tubes to produce the necessary electron supply.

An electron tube consists of a cathode, which supplies electrons, and one or more additional electrodes, which control and collect these electrons, mounted in an evacuated envelope. The envelope may be made of glass, metal, ceramic, or a combination of these materials.

## Cathodes

A cathode is an essential part of an electron tube because it supplies the electrons necessary for tube operation. When energy in some form is applied to the cathode, electrons are released. Heat is the form of energy generally used. The method of heating the cathode may be used to distinguish between the different forms of cathodes. For example, a directly heated cathode, or filament-cathode, is a wire heated by the passage of an electric current. An indirectly heated cathode, or heater-cathode, consists of a filament, or heater, enclosed in a metal sleeve. The sleeve carries the electron-emitting material on its outside surface and is heated by radiation and conduction from the heater.

A **filament, or directly heated cathode**, such as that shown in Fig. 1 may

be further classified by identifying the filament or electron-emitting material. The materials in regular use are tungsten, thoriated tungsten, and metals which have been coated with alkaline-earth oxides. Tungsten filaments are made from the pure metal. Because they must operate at high temperatures (a dazzling white) to emit sufficient electrons, a relatively large amount of filament power is required.

Thoriated-tungsten filaments are made from tungsten impregnated with thorium oxide. Due to the presence of thorium, these filaments liberate electrons at a more moderate temperature of about 1700°C (a bright yellow) and are, therefore, much more economical of filament power than are pure tungsten filaments.

Alkaline earths are usually applied as a coating on a nickel-alloy wire or ribbon. This coating, which is dried in a relatively thick layer on the filament, requires only a relatively low temperature of about 700-750°C (a dull red) to produce a copious supply of electrons. Coated filaments operate very efficiently and require relatively little filament power. However, each of these cathode materials has special advantages which determine the choice for a particular application.

Directly heated filament-cathodes require comparatively little heating power. They are used in tube types designed for battery operation because it is, of course, desirable to impose as small a drain as possible on the batteries. They are also used in rectifiers such as the 1G3GT/1B3GT and the 5Y3GT.

An **indirectly heated cathode**, or **heater-cathode**, consists of a thin metal sleeve coated with electron-emitting material such as alkaline-earth oxides. The emissive surface of the cathode is maintained at the required temperature (approximately 1050°K) by resistance-heating of a tungsten or tungsten-alloy wire which is placed inside the cathode sleeve and electrically insulated from it, as shown in Fig. 2. The heater is used only for the purpose of heating the cathode sleeve and sleeve coating to an electron-emitting temperature.

Useful emission does not take place from the heater wire.

A new dark heater insulating coating developed by RCA has better heat transfer than earlier aluminum-oxide coatings, and makes it possible to operate heaters at lower temperatures for given power inputs. Because the tensile strength of the heater wire increases at the lower operating temperatures, tubes using **dark heaters** have increased reliability, stability, and life.

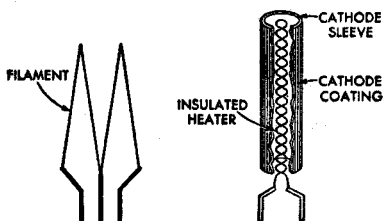

Fig. 1—Filament or directly heated cathode. Fig. 2—Indirectly heated cathode or heater-cathode.

The heater-cathode construction is well adapted for use in electron tubes intended for operation from ac power lines and from storage batteries. The use of separate parts for emitter and heater functions, the electrical insulation of the heater from the emitter, and the shielding effect of the sleeve may all be utilized in the design of the tube to minimize the introduction of hum from the ac heater supply and to minimize electrical interference which might enter the tube circuit through the heater-supply line. From the viewpoint of circuit design, the heater-cathode construction offers advantages in connection flexibility because of the electrical separation of the heater from the cathode.

Another advantage of the heater-cathode construction is that it makes practical the design of a rectifier tube having close spacing between its cathode and plate, and of an amplifier tube having close spacing between its cathode and grid. In a close-spaced rectifier tube, the voltage drop in the tube is low, and, therefore, the regulation is improved. In an amplifier tube, the close spacing increases the gain obtainable from the tube. Because of the

advantages of the heater-cathode construction, almost all present-day receiving tubes designed for ac operation have heater-cathodes.

### Generic Tube Types

Electrons are of no value in an electron tube unless they can be put to work. Therefore, a tube is designed with the parts necessary to utilize electrons as well as those required to produce them. These parts consist of a cathode and one or more supplementary electrodes. The electrodes are enclosed in an evacuated envelope having the necessary connections brought out through air-tight seals. The air is removed from the envelope to allow free movement of the electrons and to prevent injury to the emitting surface of the cathode.

When the cathode is heated, electrons leave the cathode surface and form an invisible cloud in the space around it. Any positive electric potential within the evacuated envelope offers a strong attraction to the electrons (unlike electric charges attract; like charges repel). Such a positive electric potential can be supplied by an **anode** (positive electrode) located within the tube in proximity to the cathode.

### Diodes

The simplest form of electron tube contains two electrodes, a cathode and an anode (plate), and is often called a diode, the family name for a two-electrode tube. In a diode, the positive potential is supplied by a suitable electrical source connected between the plate terminal and a cathode terminal, as shown in Fig. 3. Under the influence of the positive plate potential, electrons

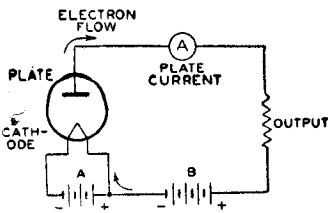

Fig. 3—Basic diode circuit.

flow from the cathode to the plate and return through the external plate-battery circuit to the cathode, thus completing the circuit. This flow of electrons is known as the **plate current**.

If a negative potential is applied to the plate, the free electrons in the space surrounding the cathode will be forced back to the cathode and no plate current will flow. If an alternating voltage is applied to the plate, the plate is alternately made positive and negative. Because plate current flows only during the time when the plate is positive, current flows through the tube in only one direction and is said to be rectified. Fig. 4 shows the rectified output current produced by an alternating input voltage.

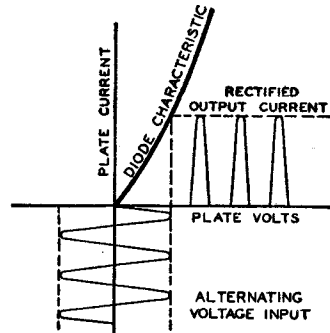

Fig. 4—Current characteristics of rectifier circuit.

Diode rectifiers are used in ac receivers to convert the ac supply voltage to dc voltage for the electrodes of the other tubes in the receiver. Rectifier tubes having only one plate and one cathode, such as the 35W4, are called **half-wave rectifiers**, because current can flow only during one-half of the alternating-current cycle. When two plates and one or more cathodes are used in the same tube, current may be obtained on both halves of the ac cycle. The 6X4, 5Y3GT, and 5U4GB are examples of this type and are called **full-wave rectifiers**.

Not all of the electrons emitted by the cathode reach the plate. Some return to the cathode, while others remain in the space between the cathode and plate for a brief period to produce

an effect known as **space charge**. This charge has a repelling action on other electrons which leave the cathode surface and impedes their passage to the plate. The extent of this action and the amount of space charge depend on the cathode temperature, the distance between the cathode and the plate, and the plate potential. The higher the plate potential, the less is the tendency for electrons to remain in the space-charge region and repel other electrons. This effect may be noted by applying increasingly higher plate voltages to a tube operating at a fixed heater or filament voltage. Under these conditions, the maximum number of available electrons is fixed, but increasingly higher plate voltages will succeed in attracting a greater proportion of the free electrons.

Beyond a certain plate voltage, however, additional plate voltage has little effect in increasing the plate current because all of the electrons emitted by the cathode are already being drawn to the plate. This maximum current, illustrated in Fig. 5, is called **saturation current**. Because it is an indication of the total number of electrons emitted, it is also known as **emission current** or simply **emission**.

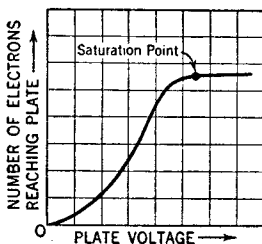

Fig. 5—Current characteristic of diode tube.

Although tubes are sometimes tested by measurement of their emission current, it is generally not advisable to measure the full value of emission because this value would be sufficiently large to cause change in the tube characteristics or even to damage the tube. Consequently, while the test value of emission current is somewhat larger than the maximum current which will be required from the cathode in the

use of the tube, it is ordinarily less than the full emission current. The emission test, therefore, is used to indicate whether the cathode can supply a sufficient number of electrons for satisfactory operation of the tube.

If space charge were not present to repel electrons coming from the cathode, the same plate current could be produced at a lower plate voltage. One way to make the effect of space charge small is to make the distance between plate and cathode small. This method is used in rectifier types having heater-cathodes, such as the 5V4GA and the 6AX5GT. In these types the radial distance between cathode and plate is only about two hundredths of an inch.

Another method of reducing space-charge effect is utilized in **mercury-vapor rectifier tubes**. When such tubes are operated, a small amount of mercury contained in the tube is partially vaporized, filling the space inside the bulb with mercury atoms. These atoms are bombarded by electrons on their way to the plate. If the electrons are moving at a sufficiently high speed, the collisions tear off electrons from the mercury atoms. The mercury atom is then said to be "**ionized**," *i.e.*, it has lost one or more electrons and, therefore, has a positive charge. Ionization is evidenced by a bluish-green glow between the cathode and plate. When ionization occurs, the space charge is neutralized by the positive mercury atoms so that increased numbers of electrons are made available. Mercury-vapor tubes are used primarily for power rectifiers.

**Ionic-heated-cathode rectifiers** depend on gas ionization for their operation. These tubes are of the full-wave design and contain two anodes and a coated cathode sealed in a bulb containing a reduced pressure of inert gas. The cathode becomes hot during tube operation, but the heating effect is caused by bombardment of the cathode by ions within the tube rather than by heater or filament current from an external source.

The internal structure of an ionic-heated-cathode tube is designed so that when sufficient voltage is applied to the tube, ionization of the gas occurs be-

tween the anode which is instantaneously positive and the cathode. Under normal operating voltages, ionization does not take place between the anode that is negative and the cathode, so that the requirements for rectification are satisfied. The initial small flow of current through the tube is sufficient to raise the cathode temperature quickly to incandescence, whereupon the cathode emits electrons. The voltage drop in such tubes is slightly higher than that of the usual hot-cathode gas rectifiers because energy is taken from the ionization discharge to keep the cathode at operating temperature. Proper operation of these rectifiers requires a minimum flow of load current at all times to maintain the cathode at the temperature required to supply sufficient emission.

### Triodes

When a third electrode, called the **grid**, is placed between the cathode and plate, the tube is known as a triode, the family name for a three-electrode tube. The grid usually consists of relatively fine wire wound on two support rods (siderods) and extending the length of the cathode. The spacing between turns of wire is large compared with the size of the wire so that the passage of electrons from cathode to plate is practically unobstructed by the grid. In some types, a **frame grid** is used. The frame consists of two siderods supported by four metal straps. Extremely fine lateral wire (diameter of 0.5 mil or less) is wound under tension around the frame. This type of grid permits the use of closer spacings between grid wires and between tube electrodes, and thus improves tube performance.

The purpose of the grid is to control the flow of plate current. When a tube is used as an amplifier, a negative dc voltage is usually applied to the grid. Under this condition the grid does not draw appreciable current.

The number of electrons attracted to the plate depends on the combined effect of the grid and plate polarities, as shown in Fig. 6. When the plate is positive, as is normal, and the dc grid volt-

age is made more and more negative, the plate is less able to attract electrons to it and plate current decreases. When the grid is made less and less negative (more and more positive), the plate more readily attracts electrons to it and plate current increases. Hence, when the voltage on the grid is varied in accordance with a signal, the plate current varies with the signal. Because a small voltage applied to the grid can control a comparatively large amount of plate current, the signal is amplified by the tube. Typical three-electrode tube types are the 6C4 and 6AF4A.

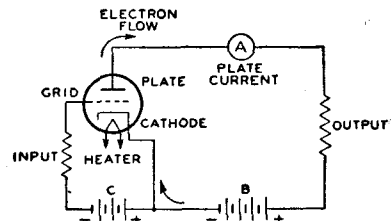

Fig. 6—Basic triode circuit.

The grid, plate, and cathode of a triode form an electrostatic system, each electrode acting as one plate of a small capacitor. The capacitances are those existing between grid and plate, plate and cathode, and grid and cathode. These capacitances are known as **inter-electrode capacitances**. Generally, the capacitance between grid and plate is of the most importance. In high-gain radio-frequency amplifier circuits, this capacitance may act to produce undesired coupling between the **input circuit**, the circuit between grid and cathode, and the **output circuit**, the circuit between plate and cathode. This coupling is undesirable in an amplifier because it may cause instability and unsatisfactory performance.

### Tetrodes

The capacitance between grid and plate can be made small by mounting an additional electrode, called the **screen grid** (grid No. 2), in the tube. With the addition of the grid No. 2, the tube has four electrodes and is, accordingly, called a tetrode. The screen

grid or grid No. 2 is mounted between the grid No. 1 (control grid) and the plate, as shown in Fig. 7, and acts as an electrostatic shield between them, thus reducing the grid-to-plate capacitance. The effectiveness of this shielding action is increased by a bypass

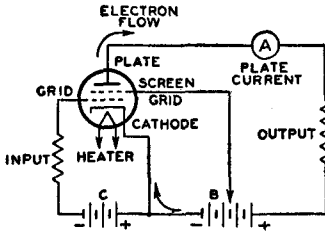

Fig. 7—Basic tetrode circuit.

capacitor connected between screen grid and cathode. By means of the screen grid and this bypass capacitor, the grid-plate capacitance of a tetrode is made very small. In practice, the grid-plate capacitance is reduced from several picofarads (pF) for a triode to 0.01 pF or less for a screen-grid tube.

The screen grid has another desirable effect in that it makes plate current practically independent of plate voltage over a certain range. The screen grid is operated at a positive voltage and, therefore, attracts electrons from the cathode. However, because of the comparatively large space between wires of the screen grid, most of the electrons drawn to the screen grid pass through it to the plate. Hence the screen grid supplies an electrostatic force pulling electrons from the cathode to the plate. At the same time the screen grid shields the electrons between cathode and screen grid from the plate so that the plate exerts very little electrostatic force on electrons near the cathode.

So long as the plate voltage is higher than the screen-grid voltage, plate current in a screen-grid tube depends to a great degree on the screen-grid voltage and very little on the plate voltage. The fact that plate current in a screen-grid tube is largely independent of plate voltage makes it possible to obtain much higher amplification with a tetrode than with a triode. The

low grid-plate capacitance makes it possible to obtain this high amplification without plate-to-grid feedback and resultant instability. In receiving-tube applications, the tetrode has been replaced to a considerable degree by the pentode.

## Pentodes

In all electron tubes, electrons striking the plate may, if moving at sufficient speed, dislodge other electrons. In two- and three-electrode types, these dislodged electrons usually do not cause trouble because no positive electrode other than the plate itself is present to attract them. These electrons, therefore, are drawn back to the plate. Emission caused by bombardment of an electrode by electrons from the cathode is called **secondary emission** because the effect is secondary to the original cathode emission.

In the case of screen-grid tubes, the proximity of the positive screen grid to the plate offers a strong attraction to these secondary electrons, and particularly so if the plate voltage swings lower than the screen-grid voltage. This effect reduces the plate current and limits the useful plate-voltage swing for tetrodes.

The effects of secondary emission are minimized when a fifth electrode is placed within the tube between the screen grid and plate. This fifth electrode is known as the **suppressor grid** (grid No. 3) and is usually connected to the cathode, as shown in Fig. 8. Because of its negative potential with respect to the plate, the suppressor grid retards the flight of secondary electrons and diverts them back to the plate.

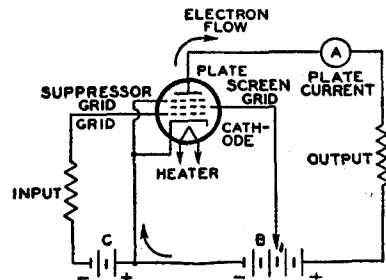

Fig. 8—Basic pentode circuit.

The family name for a five-electrode tube is "pentode." In power-output pentodes, the suppressor grid makes possible higher power output with lower grid-driving voltage; in radio-frequency amplifier pentodes, the suppressor grid makes possible high voltage amplification at moderate values of plate voltage. These desirable features result from the fact that the plate-voltage swing can be made very large. In fact, the plate voltage may be as low as, or lower than, the screen-grid voltage without serious loss in signal-gain capability. Representative pentodes used for power amplification are the 6CL6 and 6K6GT; representative pentodes used for voltage amplification are the 6AU6A, 6BA6, and 5879.

### Beam Power Tubes

A beam power tube is a tetrode or pentode in which directed electron beams are used to increase substantially the power-handling capability of the tube. Such a tube contains a cathode, a control grid (grid No. 1), a screen grid (grid No. 2), a plate, and, optionally, a suppressor grid (grid No. 3). When a beam power tube is designed without an actual suppressor grid, the electrodes are so spaced that secondary emission from the plate is suppressed by space-charge effects between screen grid and plate. The space charge is produced by the slowing up of electrons traveling from a high-potential screen grid to a lower-potential plate. In this low-velocity region, the space charge produced is sufficient to repel secondary electrons emitted from the plate and to cause them to return to the plate.

Beam power tubes of this design employ beam-confining electrodes at cathode potential to assist in producing the desired beam effects and to prevent stray electrons from the plate from returning to the screen grid outside of the beam. A feature of a beam power tube is its low screen-grid current. The screen grid and the control grid are spiral wires wound so that each turn of the screen grid is shaded from the cathode by a grid turn. This alignment of the screen

grid and control grid causes the electrons to travel in sheets between the turns of the screen grid so that very few of them strike the screen grid. Because of the effective suppressor action provided by space charge and because of the low current drawn by the screen grid, the beam power tube has the advantages of high power output, high power sensitivity, and high efficiency.

Fig. 9 shows the structure of a beam power tube employing space-charge suppression and illustrates how

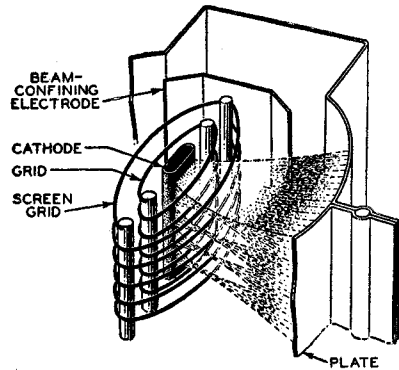

Fig. 9—Structure of beam power tube showing beam-confining action.

the electrons are confined to beams. The beam condition illustrated is that for a plate potential less than the screen-grid potential. The high-density space-charge region is indicated by the heavily dashed lines in the beam. Note that the edges of the beam-confining electrodes coincide with the dashed portion of the beam. In this way the space-charge potential region is extended beyond the beam boundaries and stray secondary electrons are prevented from returning to the screen grid outside of the beam. The space-charge effect may also be obtained by use of an actual suppressor grid. Examples of beam power tubes are 6AQ5A, 6L6GC, 6V6GTA, and 50C5.

### Multi-Electrode and Multi-Unit Tubes

Early in the history of tube devel-



opment and application, tubes were designed for a general service; that is, a single tube type—a triode—was used as a radio-frequency amplifier, an intermediate-frequency amplifier, an audio-frequency amplifier, an oscillator, or a detector. Obviously, with this diversity of application, one tube did not meet all requirements to the best advantage.

Later and present trends of tube design are the development of "specialty" types. These types are intended either to give optimum performance in a particular application or to combine in one bulb functions which formerly required two or more tubes. The first class of tubes includes such examples of specialty types as the 6CB6A and 6BY6. Types of this class generally require more than three electrodes to obtain the desired special characteristics and may be broadly classed as multi-electrode types. The 6BY6 is an especially interesting type in this class. This tube has an unusually large number of electrodes, namely seven, exclusive of the heater. Plate current in the tube is varied at two different frequencies at the same time. The tube is designed primarily for use as a combined sync separator and sync clipper in television receivers.

The second class includes multi-unit tubes such as the twin-diode triodes 6CN7 and 6AV6, as well as triode-pentodes such as the 6U8A and 6X8. This class also includes class A twin triodes such as the 6CG7 and 12AX7A, and types such as the 6CM7 containing dissimilar triode units used primarily as combined vertical oscillators and vertical deflection amplifiers in television receivers. Full-wave rectifiers are also multi-unit types.

A third class of tubes combines features of each of the other two classes. Typical of this third class are the pentagrid-converter types 6BE6 and 6SA7. These tubes are similar to the multi-electrode types in that they have seven electrodes, all of which affect the electron stream; and they are similar to the multi-unit tubes in that they perform simultaneously the double function of oscillator and mixer in superheterodyne receivers.

## Receiving Tube Structure

Receiving tubes generally utilize a glass or metal envelope and a base. Originally, the base was made of metal or molded phenolic material. Types having a glass envelope and a molded phenolic base include the "octal" types such as the 5U4GB and the 6SN7GTB. Types having a metal envelope and molded phenolic octal base include the 6F6 and the 6L6. Many modern types utilize integral glass bases. Present-day conventional tube designs utilizing glass envelopes and integral glass bases include the seven-pin and nine-pin **miniature** types, the nine-pin **novar** and **neonov**al types, and the twelve-pin **duodecar** types. Examples of the seven-pin miniature types are the 6AU6A and 6BN6. Examples of the nine-pin miniature types are the 12AU7A and 6EA8. Examples of the novar types are the 6BH3 and 7868. The nine-pin base for the novar types has a relatively large pin-circle diameter and long pins to insure firm retention of the tube in its socket.

The **nuvistor** concept provided a new approach to electron tube design. Nuvistor tubes utilize a light-weight cantilever-supported cylindrical electrode structure housed in a ceramic-metal envelope. These tubes combine new materials, processes, and fabrication techniques. Examples of the nuvistor are the 6CW4 and the 6DV4.

## Television Picture Tubes

The picture tube, or kinescope, is a multi-electrode tube used principally in television receivers for picture display. It consists essentially of an electron gun, a glass or metal-and-glass envelope and face-plate combination, and a fluorescent screen.

The electron gun includes a cathode for the production of free electrons, one or more control electrodes for accelerating the electrons in the beam, and, optionally, a device for "trapping" unwanted ions out of the electron beam.

Focusing of the beam is accomplished either electromagnetically by

means of a focusing coil placed on the neck of the tube, or electrostatically, as shown in Fig. 10, by means of a focusing electrode (grid No. 4) within the envelope of the tube. The screen is a white-fluorescing phosphor P4 of either the silicate or the sulfide type.

Deflection of the beam is accomplished either electrostatically by means of deflecting electrodes within the envelope of the tube, or electromagnetically by means of a deflecting yoke placed on the neck of the tube. Fig. 10 shows the structure of the gun section of a picture tube and illustrates how the electron beam is formed and how the beam is deflected by means of an electromagnetic deflecting yoke. In this type of tube, ions in the beam are prevented from damaging the fluorescent screen by an aluminum film on the gun side of the screen. This film not only "traps" unwanted ions, but also improves picture contrast. In many types of non-aluminized tubes, ions are separated from the electron beam by means of a tilted-gun and ion-trap-magnet arrangement.

**Color television picture tubes** are similar to black-and-white picture tubes, but differ in three major ways: (1) The light-emitting screen is made up of trios

of phosphor dots deposited in an interlaced pattern. Each dot of a trio is capable of emitting light in one of the three primary colors (red, green, or blue). (2) A shadow mask mounted near the screen of the tube contains over 300,000 apertures, one for each of the phosphor dot trios. This mask provides color separation by shadowing two of the three phosphor dots of each trio. (3) Three closely spaced electron guns, built as a unit, provide separate beams for excitation of the three different color-phosphor-dot arrays. Thus it is possible to control the brightness of each of the three colors independently of the other two. Fig. 11 shows a cut-away view of a color television picture tube.

The three electron guns are mounted with their axes tilted toward the central axis of the envelope, and are spaced 120 degrees with respect to each other. The focusing electrodes of the three guns are interconnected internally, and their potential is adjusted to cause the separate beams to focus at the phosphor-dot screen. All three beams must be made to converge at the screen while they are simultaneously being deflected. Convergence is accomplished by the action of static and

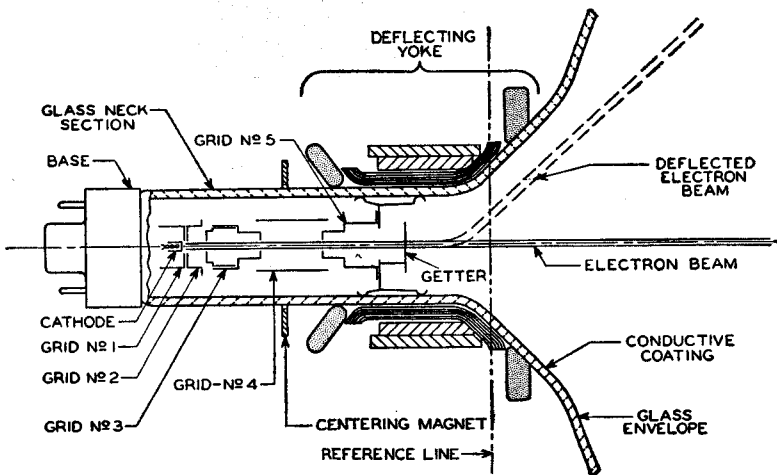

Fig. 10—Structure of television-picture-tube electron gun.

dynamic magnetic fields set up by the radial-converging magnet assembly mounted on the neck of the tube. These fields are coupled into the radial-converging pole pieces within the tube. Another pair of pole pieces in the tube is activated by the lateral-converging magnet also mounted on the neck of the tube. These pole pieces permit lateral shift in position of the blue beam in opposition to the lateral shift of the green and red beams.

A purifying magnet is used with color picture tubes to provide a magnetic field, adjustable in magnitude and direction, to effect register over the entire area of the screen. A magnetic shield is used to minimize the effects of the earth's magnetic field.

Deflection of the three beams is accomplished simultaneously by a deflecting yoke using four electromagnetic coils similar to the deflection yoke used for black-and-white picture tubes.

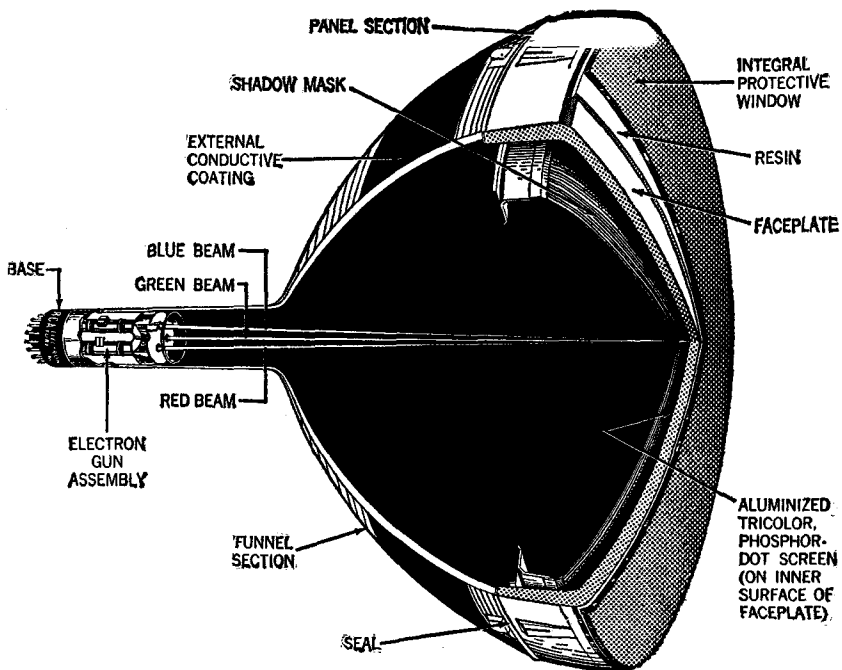

Fig. 11—Cutaway view of color television picture tube.

# Electron Tube Characteristics

**T**HE term "characteristics" is used to identify the distinguishing electrical features and values of an electron tube. These values may be shown in curve form or they may be tabulated. When the characteristics values are given in curve form, the curves may be used for the determination of tube performance and the calculation of additional tube factors.

Tube characteristics are obtained from electrical measurements of a tube in various circuits under certain definite conditions of voltages. Characteristics may be further described by denoting the conditions of measurements. For example, Static Characteristics are the values obtained with different dc potentials applied to the tube electrodes, while Dynamic Characteristics are the values obtained with an ac voltage on a control grid under various conditions of dc potentials on the electrodes. The dynamic characteristics, therefore, are indicative of the performance capabilities of a tube under actual working conditions.

**Static characteristics** may be shown by plate characteristics curves and transfer (mutual) characteristics curves. These curves present the same information, but in two different forms to increase its usefulness. The plate characteristic curve is obtained by varying plate voltage and measuring plate current for different grid-bias voltages, while the transfer-characteristic curve is obtained by varying grid-bias voltage and measuring plate current for different plate voltages. A plate-characteristic family of curves is shown in Fig. 12. Fig. 13 gives the transfer-characteristic family of curves for the same tube.

**Dynamic characteristics** include amplification factor, plate resistance, control-grid—plate transconductance, and certain detector characteristics, and may be shown in curve form for variations in tube operating conditions.

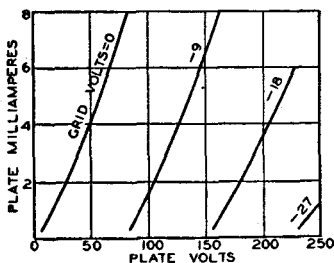

Fig. 12—Family of plate-characteristics curves.

The **amplification factor**, or  $\mu$ , is the ratio of the change in plate voltage to a change in control-electrode voltage in the opposite direction, under the condition that the plate current remains

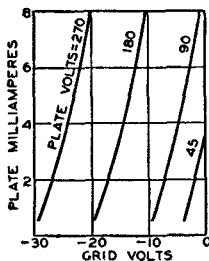

Fig. 13—Family of transfer-characteristics curves.

unchanged and that all other electrode voltages are maintained constant. For example, if, when the plate voltage

is made 1 volt more positive, the control-electrode (grid-No. 1) voltage must be made 0.1 volt more negative to hold plate current unchanged, the amplification factor is 1 divided by 0.1, or 10. In other words, a small voltage variation in the grid circuit of a tube has the same effect on the plate current as a large plate-voltage change—the latter equal to the product of the grid-voltage change and amplification factor. The  $\mu$  of a tube is often useful for calculating stage gain. This use is discussed in the **Electron Tube Applications** section.

**Plate resistance** ( $r_p$ ) of an electron tube is the resistance of the path between cathode and plate to the flow of alternating current. It is the quotient of a small change in plate voltage divided by the corresponding change in plate current and is expressed in ohms, the unit of resistance. Thus, if a change of 0.1 milliamper (0.0001 ampere) is produced by a plate-voltage variation of 1 volt, the plate resistance is 1 divided by 0.0001, or 10000 ohms.

**Control-grid—plate transconductance**, or simply **transconductance** ( $g_m$ ), is a factor which combines in one term the amplification factor and the plate resistance, and is the quotient of the first divided by the second. This term has also been known as mutual conductance. Transconductance may be more strictly defined as the quotient of a small change in plate current (amperes) divided by the small change in the control-grid voltage producing it, under the condition that all other voltages remain unchanged. Thus, if a grid-

voltage change of 0.5 volt causes a plate-current change of 1 milliamper (0.001 ampere), with all other voltages constant, the transconductance is 0.001 divided by 0.5, or 0.002 mho. A "mho" is the unit of conductance and was named by spelling ohm backwards. For convenience, a millionth of a mho, or a micromho ( $\mu$ mho), is used to express transconductance. Thus, in the example, 0.002 mho is 2000 micromhos.

**Conversion transconductance** ( $g_c$ ) is a characteristic associated with the mixer (first detector) function of tubes and may be defined as the quotient of the intermediate-frequency (if) current in the primary of the if transformer divided by the applied radio-frequency (rf) voltage producing it; more precisely, it is the limiting value of this quotient as the rf voltage and if current approach zero. When the performance of a frequency converter is determined, conversion transconductance is used in the same way as control-grid—plate transconductance is used in single-frequency amplifier computations.

The **plate efficiency** of a power amplifier tube is the ratio of the ac power output ( $P_o$ ) to the product of the average dc plate voltage ( $E_b$ ) and dc plate current ( $I_b$ ) at full signal, or

$$\text{Plate efficiency} \% = \frac{P_o \text{ watts}}{E_b \text{ volts} \times I_b \text{ amperes}} \times 100$$

The **power sensitivity** of a tube is the ratio of the power output to the square of the input signal voltage ( $E_{i_s}$ ), and is expressed in mhos as follows:

$$\text{Power sensitivity (mhos)} = \frac{P_o \text{ watts}}{(E_{i_s} \text{ rms})^2}$$

# Electron Tube Applications

**T**HE diversified applications of an electron receiving tube have, within the scope of this section, been treated under seven headings. These are: Amplification, Rectification, Detection, Automatic Volume or Gain Control, Oscillation, Frequency Conversion, and Automatic Frequency Control. Although these operations may take place at either radio or audio frequencies and may involve the use of different circuits and different supplemental parts, the general considerations of each kind of operation are basic.

## Amplification

The amplifying action of an electron tube was mentioned under **Triodes** in the section on **Electrons, Electrodes, and Electron Tubes**. This action can be utilized in electronic circuits in a number of ways, depending upon the results desired. Four classes of amplifier service recognized by engineers are covered by definitions standardized by the Institute of Radio Engineers (now the Institute of Electrical and Electronics Engineers). This classification depends primarily on the fraction of input cycle during which plate current is expected to flow under rated full-load conditions. The classes are class A, class AB, class B, and class C. The term "cutoff bias" used in these definitions is the value of grid bias at which plate current is very small.

### *Classes of Service*

A **class A amplifier** is an amplifier in which the grid bias and alternating grid voltages are such that plate current in a specific tube flows at all times.

A **class AB amplifier** is an amplifier in which the grid bias and alternating grid voltages are such that plate current in a specific tube flows for appreciably more than half but less than the entire electrical cycle.

A **class B amplifier** is an amplifier in which the grid bias is approximately equal to the cutoff value, so that the plate current is approximately zero when no exciting grid voltage is applied, and so that plate current in a specific tube flows for approximately one-half of each cycle when an alternating grid voltage is applied.

A **class C amplifier** is an amplifier in which the grid bias is appreciably greater than the cutoff value, so that the plate current in each tube is zero when no alternating grid voltage is applied, and so that plate current flows in a specific tube for appreciably less than one-half of each cycle when an alternating grid voltage is applied.

The suffix 1 may be added to the letter or letters of the class identification to denote that grid current does not flow during any part of the input cycle. The suffix 2 may be used to denote that grid current flows during part of the cycle.

For radio-frequency (rf) amplifiers which operate into a selective tuned circuit, as in radio transmitter applications, or under requirements where distortion is not an important factor, any of the above classes of amplifiers may be used, either with a single tube or with a push-pull stage. For audio-frequency (af) amplifiers in which distortion is an important factor, only class A amplifiers permit single-tube operation. In this case, operating con-

ditions are usually chosen so that distortion is kept below the conventional 5 per cent for triodes and the conventional 7 to 10 per cent for tetrodes or pentodes. Distortion can be reduced below these figures by means of special circuit arrangements such as that discussed under **inverse feedback**. With class A amplifiers, reduced distortion with improved power performance can be obtained by using a push-pull stage for audio service. With class AB and class B amplifiers, a balanced stage using two tubes is required for audio service.

### Class A Voltage Amplifiers

As a class A voltage amplifier, an electron tube is used to reproduce grid-voltage variations across an impedance or a resistance in the plate circuit. These variations are essentially of the same form as the input signal voltage impressed on the grid, but their amplitude is increased. This increase is accomplished by operation of the tube at a suitable grid bias so that the applied grid input voltage produces plate-current variations proportional to the signal swings. Because the voltage variation obtained in the plate circuit is much larger than that required to swing the grid, amplification of the signal is obtained.

Fig. 14 gives a graphical illustration of this method of amplification and shows, by means of the grid-voltage vs. plate-current characteristics curve, the effect of an input signal (S) applied to the grid of a tube. The output signal (O)

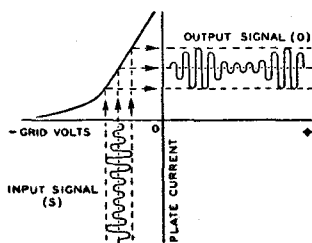

Fig. 14—Current characteristics of class A amplifier.

is the resulting amplified plate-current variation.

The plate current flowing through the load resistance (R) of Fig. 15 causes a voltage drop which varies directly with the plate current. The ratio of this voltage variation produced in the load resistance to the input signal voltage is

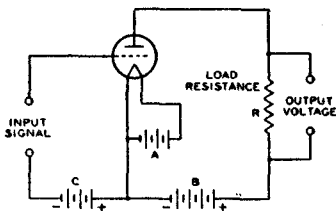

Fig. 15—Triode amplifier circuit.

the voltage amplification, or **gain**, provided by the tube. The voltage amplification due to the tube is expressed by the following convenient formulas:

$$\text{Voltage amplification} = \frac{\mu \times R_L}{R_L + r_p}$$

$$\text{or } \frac{g_m \times r_p \times R_L}{1000000 \times (r_p + R_L)}$$

where  $\mu$  is the amplification factor of the tube,  $R_L$  is the load resistance in ohms,  $r_p$  is the plate resistance in ohms, and  $g_m$  is the transconductance in micromhos.

From the first formula, it can be seen that the gain actually obtainable from the tube is less than the tube amplification factor, but that the gain approaches the amplification factor when the load resistance is large compared to the tube plate resistance. Fig. 16 shows graphically how the gain approaches the amplification factor of the tube as the load resistance is increased. From the curve it can be seen that a high value of load resistance should be used to obtain high gain in a voltage amplifier.

In a **resistance-coupled amplifier**, the load resistance of the tube is approximately equal to the resistance of the plate resistor in parallel with the grid resistor of the following stage. Hence, to obtain a large value of load resistance, it is necessary to use a plate resistor and a grid resistor of large



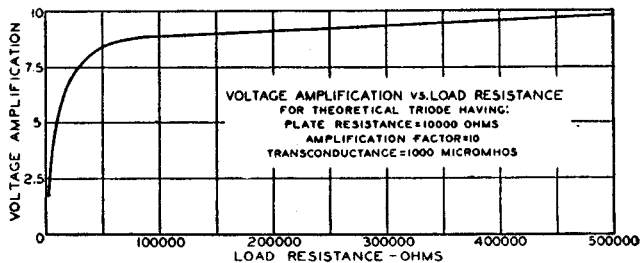

Fig. 16—Gain curve for triode amplifier circuit.

resistance. However, the plate resistor should not be too large because the flow of plate current through the plate resistor produces a voltage drop which reduces the plate voltage applied to the tube. If the plate resistor is too large, this drop will be too large, the plate voltage on the tube will be too small, and the voltage output of the tube will be too small. Also, the grid resistor of the following stage should not be too large, the actual maximum value being dependent on the particular tube type. This precaution is necessary because all tubes contain minute amounts of residual gas which cause a minute flow of current through the grid resistor. If the grid resistor is too large, the positive bias developed by the flow of this current through the resistor decreases the normal negative bias and produces an increase in the plate current. This increased current may overheat the tube and cause liberation of more gas which, in turn, will cause further decrease in bias. The action is cumulative and results in a runaway condition which can destroy the tube.

A higher value of grid resistance is permissible when cathode-resistor bias is used than when fixed bias is used. When cathode-resistor bias is used, a loss in bias due to gas or grid-emission effects is almost completely offset by an increase in bias due to the voltage drop across the cathode resistor. Typical values of plate resistor and grid resistor for tube types used in resistance-coupled circuits, and the values of gain obtainable, are shown in the **Resistance-Coupled Amplifier** section.

The **input impedance** of an electron tube (that is, the impedance between grid and cathode) consists of (1) a reactive component due to the capacitance between grid and cathode, (2) a resistive component resulting from the time of transit of electrons between cathode and grid, and (3) a resistive component developed by the part of the cathode lead inductance which is common to both the input and output circuits. Components (2) and (3) are dependent on the frequency of the incoming signal. The input impedance is very high at audio frequencies when a tube is operated with its grid biased negative. In a class  $A_1$  or  $AB_1$  transformer-coupled audio amplifier, therefore, the loading imposed by the grid on the input transformer is negligible. As a result, the secondary impedance of a class  $A_1$  or class  $AB_1$  input transformer can be made very high because the choice is not limited by the input impedance of the tube; however, transformer design considerations may limit the choice.

At the higher radio frequencies, the input impedance may become very low even when the grid is negative, due to the finite time of passage of electrons between cathode and grid and to the appreciable lead reactance. This impedance drops very rapidly as the frequency is raised, and increases input-circuit loading. In fact, the input impedance may become low enough at very high radio frequencies to affect the gain and selectivity of a preceding stage appreciably. Tubes such as the "acorn" and "pencil" types and the high-frequency miniatures have been

developed to have low input capacitances, low electron-transit time, and low lead inductance so that their input impedance is high even at the ultra-high radio frequencies. **Input admittance** is the reciprocal of input impedance.

A **remote-cutoff amplifier** tube is a modified construction of a pentode or a tetrode type designed to reduce modulation-distortion and cross-modulation in radio-frequency stages. **Cross-modulation** is the effect produced in a radio or television receiver by an interfering station "riding through" on the carrier of the station to which the receiver is tuned. **Modulation-distortion** is a distortion of the modulated carrier and appears as audio-frequency distortion in the output. This effect is produced by a radio-frequency amplifier stage operating on an excessively curved characteristic when the grid bias has been increased to reduce volume. The offending stage for cross-modulation is usually the first radio-frequency amplifier, while for modulation-distortion the cause is usually the last intermediate-frequency stage. The characteristics of remote-cutoff types are such as to enable them to handle both large and small input signals with minimum distortion over a wide range of signal strength.

Fig. 17 illustrates the construction of the grid No. 1 (control grid) in a remote-cutoff tube. The remote-cutoff

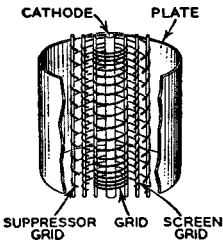

Fig. 17—Structure of remote-cutoff grid.

action is due to the structure of the grid which provides a variation in amplification factor with change in grid bias. The grid No. 1 is wound with open spacing at the middle and with close spacing

at the ends. When weak signals and low grid bias are applied to the tube, the effect of the non-uniform turn spacing of the grid on cathode emission and tube characteristics is essentially the same as for uniform spacing. As the grid bias is made more negative to handle larger input signals, the electron flow from the sections of the cathode enclosed by the ends of the grid is cut off. The plate current and other tube characteristics are then dependent on the electron flow through the open section of the grid. This action changes the gain of the tube so that large signals may be handled with minimum distortion due to cross-modulation and modulation-distortion.

Fig. 18 shows a typical plate-current vs. grid-voltage curve for a remote-cutoff type compared with the curve

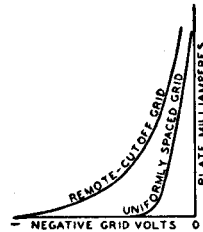

Fig. 18—Plate-current curves for triodes having remote-cutoff and uniformly spaced grids.

for a type having a uniformly spaced grid. It will be noted that while the curves are similar at small grid-bias voltages, the plate current of the remote-cutoff tube drops quite slowly with large values of bias voltage. This slow change makes it possible for the tube to handle large signals satisfactorily. Because remote-cutoff types can accommodate large and small signals, they are particularly suitable for use in sets having automatic volume control. Remote-cutoff tubes also are known as **variable- $\mu$**  types.

### Class A Power Amplifiers

As a class A power amplifier, an electron tube is used in the output stage of a radio or television receiver to supply a relatively large amount of power

to the loudspeaker. For this application, large power output is of more importance than high voltage amplification; therefore, gain possibilities are sacrificed in the design of power tubes to obtain power-handling capability.

Triodes, pentodes, and beam power tubes designed for power amplifier service have certain inherent features for each structure. Power tubes of the triode type for class A service are characterized by low power sensitivity, low plate-power efficiency, and low distortion. Power tubes of the pentode type are characterized by high power sensitivity, high plate-power efficiency and, usually, somewhat higher distortion than class A triodes. Beam power tubes have higher power sensitivity and efficiency than triode or conventional pentode types.

A class A power amplifier is also used as a driver to supply power to a class AB<sub>2</sub> or a class B stage. It is usually advisable to use a triode, rather than a pentode, in a driver stage because of the lower plate impedance of the triode.

Power tubes connected in either **parallel** or **push-pull** may be employed as class A amplifiers to obtain increased output. The parallel connection (Fig. 19) provides twice the output of a single tube with the same value of grid-signal voltage. With this connection,

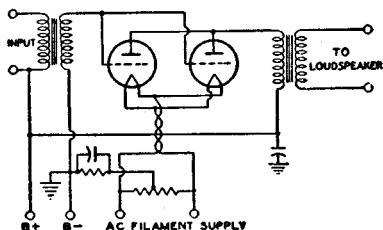

Fig. 19—Power amplifier with tubes connected in parallel.

the effective transconductance of the stage is doubled, and the effective plate resistance and the load resistance required are halved as compared with single-tube values.

The push-pull connection (Fig. 20), although it requires twice the grid-

signal voltage, provides increased power and has other important advantages

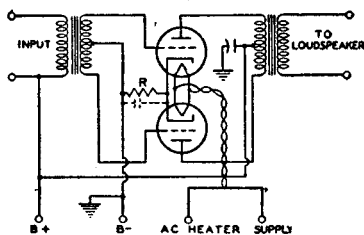

Fig. 20—Power amplifier with tubes connected in push-pull.

over single-tube operation. Distortion caused by even-order harmonics and hum caused by plate-voltage-supply fluctuations are either eliminated or decidedly reduced through cancellation. Because distortion for push-pull operation is less than for single-tube operation, appreciably more than twice single-tube output can be obtained with triodes by decreasing the load resistance for the stage to a value approaching the load resistance for a single tube.

For either parallel or push-pull class A operation of two tubes, all electrode currents are doubled while all dc electrode voltages remain the same as for single-tube operation. If a cathode resistor is used, its value should be about one-half that for a single tube. If oscillations occur with either type of connection, they can often be eliminated by the use of a non-inductive resistor of approximately 100 ohms connected in series with each grid at the socket terminal.

Operation of power tubes so that the grids run positive is inadvisable except under conditions such as those discussed in this section for class AB and class B amplifiers.

### Power-Output Calculations

Calculation of the power output of a triode used as a class A amplifier with either an output transformer or a choke having low dc resistance can be made without serious error from the plate family of curves by assuming a resistance load. The proper plate current, grid bias, optimum load resistance, and

per-cent second-harmonic distortion can also be determined. The calculations are made graphically and are illustrated in Fig. 21 for given conditions. The procedure is as follows:

(1) Locate the zero-signal bias point P by determining the zero-signal bias  $E_c$  from the formula:

$$\text{Zero-signal bias } (E_{c0}) = -(0.68 \times E_b) / \mu$$

where  $E_b$  is the chosen value in volts of dc plate voltage at which the tube is to be operated, and  $\mu$  is the amplification factor of the tube. This quantity is shown as negative to indicate that a negative bias is used.

(2) Locate the value of zero-signal plate current,  $I_0$ , corresponding to point P.

(3) Locate the point  $2I_0$ , which is twice the value of  $I_0$  and corresponds to the value of the maximum-signal plate current  $I_{max}$ .

(4) Locate the point X on the dc bias curve at zero volts,  $E_c = 0$ , corresponding to the value of  $I_{max}$ .

(5) Draw a straight line XY through X and P.

Line XY is known as the load resistance line. Its slope corresponds to the value of the load resistance. The load resistance in ohms is equal to  $(E_{max} - E_{min})$  divided by  $(I_{max} - I_{min})$ , where E is in volts and I is in amperes.

It should be noted that in the case of filament types of tubes, the calculations are given on the basis of a dc-operated filament. When the filament is ac-operated, the calculated value of dc bias should be increased by approximately one-half the filament voltage rating of the tube.

The value of zero-signal plate current  $I_0$  should be used to determine the plate dissipation, an important factor influencing tube life. In a class A amplifier under zero-signal conditions, the plate dissipation is equal to the power input, *i.e.*, the product of the dc plate voltage  $E_0$  and the zero-signal dc plate current  $I_0$ . If it is found that the plate-dissipation rating of the tube is exceeded with the zero-signal bias  $E_{c0}$  calculated above, it will be necessary to increase the bias by a sufficient amount so that the actual plate dissipation does not exceed the rating before proceeding further with the remaining calculations.

For power-output calculations, it is assumed that the peak alternating grid voltage is sufficient (1) to swing the grid from the zero-signal bias value  $E_{c0}$  to zero bias ( $E_c = 0$ ) on the positive swing and (2) to swing the grid to a value twice the zero-signal bias value on the negative swing. During the negative swing, the plate voltage and plate current reach values of  $E_{max}$  and  $I_{min}$ ; during the positive swing, they reach values of  $E_{min}$  and  $I_{max}$ . Because power is the product of voltage and current, the power output  $P_0$  as shown by a watt-meter is given by

$$P_0 = \frac{(I_{max} - I_{min}) \times (E_{max} - E_{min})}{8}$$

where E is in volts, I is in amperes, and  $P_0$  is in watts.

In the output of power-amplifier triodes, some distortion is present. This distortion is due predominantly to second harmonics in single-tube amplifiers. The percentage of second-harmonic distortion may be calculated by the following formula:

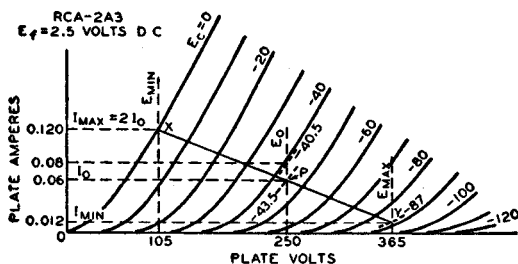

Fig. 21—Graphic calculations for class A amplifier using the 2A3 power triode.

$$\% \text{ distortion} = \frac{I_{\max} + I_{\min} - I_0}{I_{\max} - I_{\min}} \times 100$$

where  $I_0$  is the zero-signal plate current in amperes. If the distortion is excessive, the load resistance should be increased or, occasionally, decreased slightly and the calculations repeated.

**Example:** Determine the load resistance, power output, and distortion of a triode having an amplification factor of 4.2, a plate-dissipation rating of 15 watts, and plate-characteristics curves as shown in Fig. 21. The tube is to be operated at 250 volts on the plate.

**Procedure:** For a first approximation, determine the operating point P from the zero-signal bias formula,  $E_c = -(0.68 \times 250) / 4.2 = -40.5$  volts. From the curve for this voltage, it is found that the zero-signal plate current is 0.08 ampere and, therefore, the plate-dissipation rating is exceeded ( $0.08 \times 250 = 20$  watts). Consequently, it is necessary to reduce the zero-signal plate current to 0.06 ampere at 250 volts. The grid bias is then  $-43.5$  volts. Note that the curve was taken with a dc filament supply; if the filament is to be operated on an ac supply, the bias must be increased by about one-half the filament voltage, or to  $-45$  volts, and the circuit returns made to the mid-point of the filament circuit.

Point X can then be determined. Point X is at the intersection of the dc bias curve at zero volts with  $I_{\max}$ , where  $I_{\max} = 2I_0 = 2 \times 0.06 = 0.12$  ampere. Line XY is drawn through points P and X.  $E_{\max}$ ,  $E_{\min}$ , and  $I_{\min}$  are then found from the curves. When these values are substituted in the power-output formula, the following result is obtained:

$$P_o = \frac{(0.12 - 0.012) \times (365 - 105)}{8} = 3.52 \text{ watts}$$

The resistance represented by load line XY is

$$\frac{(365 - 105)}{(0.12 - 0.012)} = 2410 \text{ ohms}$$

When the values from the curves are substituted in the distortion formula, the following result is obtained:

$$\% \text{ distortion} = \frac{0.12 + 0.012}{2} - 0.06 \times 100 = 5.5\%$$

It is customary to select the load resistance so that the distortion does not exceed five per cent. When the method shown is used to determine the slope of the load-resistance line, the second-harmonic distortion generally does not exceed five per cent. In the example, however, the distortion is excessive and it is desirable, therefore, to use a slightly higher load resistance. A load resistance of 2500 ohms will provide a distortion of about 4.9 per cent. The power output is reduced only slightly to 3.5 watts.

Operating conditions for **triodes in push-pull** depend on the type of operation desired. Under class A conditions, distortion, power output, and efficiency are all relatively low. The operating bias can be anywhere between that specified for single-tube operation and that equal to one-half the grid-bias voltage required to produce plate-current cutoff at a plate voltage of  $1.4E_o$ , where  $E_o$  is the operating plate voltage. Higher bias than this value requires higher grid-signal voltage and results in class AB<sub>1</sub> operation, which is discussed later.

The method for calculating maximum power output for **triodes in push-pull class A operation** is as follows: Erect a vertical line at  $0.6 E_o$  (see Fig. 22, intersecting the  $E_c = 0$  curve at the point  $I_{\max}$ . Then,  $I_{\max}$  is determined from the curve for use in the formula

$$P_o = (I_{\max} \times E_o) / 5$$

If  $I_{\max}$  is expressed in amperes and  $E_o$  in volts, power output is in watts.

The method for determining the proper load resistance for triodes in push-pull is as follows: Draw a load line through  $I_{\max}$  on the zero-bias curve and through the  $E_o$  point on the zero-current axis. Four times the resistance represented by this load line is the plate-to-plate load ( $R_{pp}$ ) for two triodes in a class A push-pull amplifier. Expressed as a formula,

$$R_{pp} = 4 \times (E_o - 0.6E_o) / I_{\max}$$

where  $E_o$  is expressed in volts,  $I_{\max}$  in amperes, and  $R_{pp}$  in ohms.

**Example:** Assume that the plate voltage ( $E_o$ ) is to be 300 volts, and the plate-dissipation rating of the tube is 15

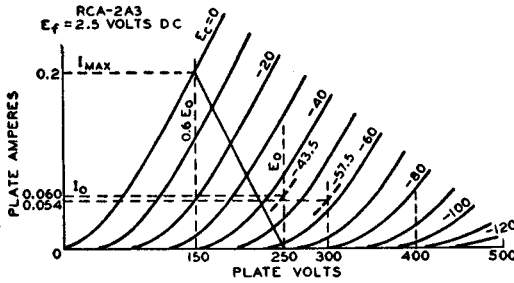

Fig. 22—Graphic calculations for push-pull class A amplifier using the 2A3 power triode.

watts. Then, for class A operation, the operating bias can be equal to, but not more than, one-half the grid bias for cutoff with a plate voltage of  $1.4 \times 300 = 420$  volts. (Since cutoff bias is approximately  $-115$  volts at a plate voltage of 420 volts, one-half of this value is  $-57.5$  volts bias.) At this bias, the plate current is found from the plate family to be 0.054 ampere and, therefore, the plate dissipation is  $0.054 \times 300$  or 16.2 watts. Since  $-57.5$  volts is the limit of bias for class A operation of these tubes at a plate voltage of 300 volts, the dissipation cannot be reduced by increasing the bias and it becomes necessary to reduce the plate voltage.

If the plate voltage is reduced to 250 volts, the bias will be found to be  $-43.5$  volts. For this value, the plate current is 0.06 ampere, and the plate dissipation is 15 watts. Then, following

the method for calculating power output, erect a vertical line at  $0.6E_0 = 150$  volts. The intersection of the line with the curve  $E_c = 0$  is  $I_{max}$  or 0.2 ampere. When this value is substituted in the power formula, the power output is  $(0.2 \times 250)/5 = 10$  watts. The load resistance is determined from the load formula: Plate-to-plate load ( $R_{pp}$ ) =  $4 \times (250 - 150)/0.2 = 2000$  ohms.

**Power output for a pentode or a beam power tube as a class A amplifier** can be calculated in much the same way as for triodes. The calculations can be made graphically from a special plate family of curves, as illustrated in Fig. 23

From a point A at or just below the knee of the zero-bias curve, draw arbitrarily selected load lines to intersect the zero-plate-current axis. These lines should be on both sides of the operating point P, whose position is

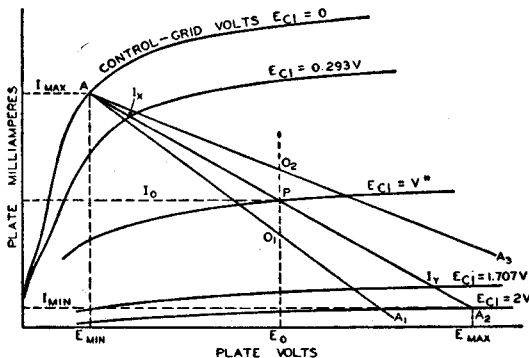

Fig. 23—Graphic calculations for class A amplifier using a pentode or beam power tube.

determined by the desired operating plate voltage,  $E_o$ , and one-half the maximum-signal plate current. Along any load line, say  $AA_1$ , measure the distance  $AO_1$ . On the same line, lay off an equal distance,  $O_1A_1$ . For optimum operation, the change in bias from  $A$  to  $O_1$  should be nearly equal to the change in bias from  $O_1$  to  $A_1$ . If this condition can not be met with one line, as is the case for the line first chosen, then another should be chosen. When the most satisfactory line has been selected, its resistance may be determined by the following formula:

$$\text{Load resistance (R}_L\text{)} = \frac{E_{\text{max}} - E_{\text{min}}}{I_{\text{max}} - I_{\text{min}}}$$

The value of  $R_L$  may then be substituted in the following formula for calculating power output.

$$P_o = \frac{[I_{\text{max}} - I_{\text{min}} + 1.41 (I_x - I_y)]^2 R_L}{32}$$

In both of these formulas,  $I$  is in amperes,  $E$  is in volts,  $R_L$  is in ohms, and  $P_o$  is in watts.  $I_x$  and  $I_y$  are the current values on the load line at bias voltages of  $E_{c1} = V - 0.707V = 0.293V$  and  $E_{c1} = V + 0.707V = 1.707V$ , respectively.

Calculations for distortion may be made by means of the following formulas. The terms used have already been defined.

$$\% \text{ 2nd-harmonic distortion} = \frac{I_{\text{max}} + I_{\text{min}} - 2 I_o}{I_{\text{max}} - I_{\text{min}} + 1.41 (I_x - I_y)} \times 100$$

$$\% \text{ 3rd-harmonic distortion} = \frac{I_{\text{max}} - I_{\text{min}} - 1.41 (I_x - I_y)}{I_{\text{max}} - I_{\text{min}} + 1.41 (I_x - I_y)} \times 100$$

$$\% \text{ total (2nd and 3rd) harmonic distortion} = \frac{\sqrt{(\% \text{ 2nd})^2 + (\% \text{ 3rd})^2}}$$

### Conversion Factors

Operating conditions for voltage values other than those shown in the published data can be obtained by use of the **nomograph** shown in Fig. 24 when all electrode voltages are changed simultaneously in the same ratio. The nomograph includes conversion factors for current ( $F_i$ ), power output ( $F_p$ ), plate resistance or load resistance ( $F_r$ ),

and transconductance ( $F_{gm}$ ) for voltage ratios between 0.5 and 2.0. These factors are expressed as functions of the ratio between the desired or new voltage for any electrode ( $E_{des}$ ) and the published or original value of that voltage ( $E_{pub}$ ). The relations shown are applicable to triodes and multigrid tubes in all classes of service.

To use the nomograph, simply place a straight-edge across the page so that it intersects the scales for  $E_{des}$  and  $E_{pub}$  at the desired values. The desired conversion factor may then be read directly or estimated at the point where the straight-edge intersects the  $F_i$ ,  $F_p$ ,  $F_r$ , or  $F_{gm}$  scale.

For example, suppose it is desired to operate two 6L6GC's in class  $A_1$  push-pull, fixed bias, with a plate voltage of 200 volts. The nearest published operating conditions for this class of service are for a plate voltage of 250 volts. The operating conditions for the new plate voltage can be determined as follows:

The voltage conversion factor,  $F_v$ , is equal to  $200/250$  or 0.8. The dashed lines on the nomograph of Fig. 24 indicate that for this voltage ratio  $F_i$  is approximately 0.72,  $F_p$  is approximately 0.57,  $F_r$  is 1.12, and  $F_{gm}$  is approximately 0.892. These factors may be applied directly to operating values shown in the tube data, or to values calculated by the methods described previously.

Because this method for conversion of characteristics is necessarily an approximation, the accuracy of the nomograph decreases progressively as the ratio  $E_{des}/E_{pub}$  departs from unity. In general, results are substantially correct when the value of the ratio  $E_{des}/E_{pub}$  is between 0.7 and 1.5. Beyond these limits, the accuracy decreases rapidly, and the results obtained must be considered rough approximations.

The nomograph does not take into consideration the effects of contact potential or secondary emission in tubes. Because contact-potential effects become noticeable only at very small dc grid-No. 1 (bias) voltages, they are generally negligible in power tubes.



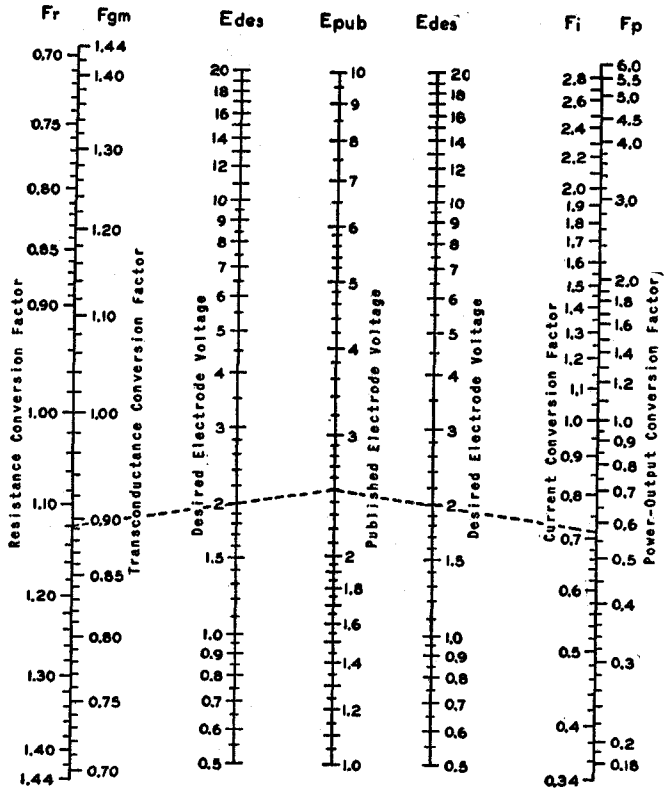

Fig. 24—Nomograph of tube conversion factors.

Secondary emission may occur in conventional tetrodes, however, if the plate voltage swings below the grid-No. 2 voltage. Consequently, the conversion factors shown in the nomograph apply to such tubes only when the plate voltage is greater than the grid-No. 2 voltage. Because secondary emission may also occur in certain beam power tubes at very low values of plate current and plate voltage, the conversion factors shown in the nomograph do not apply when these tubes are operated under such conditions.

**Class AB Power Amplifiers**

A class AB power amplifier employs two tubes connected in push-pull with a higher negative grid bias than is used in a class A stage. With this higher negative bias, the plate and screen-

grid voltages can usually be made higher than for class A amplifiers because the increased negative bias holds plate current within the limit of the tube plate-dissipation rating. As a result of these higher voltages, more power output can be obtained from class AB operation.

Class AB amplifiers are subdivided into class AB<sub>1</sub> and class AB<sub>2</sub>. In class AB<sub>1</sub>, there is no flow of grid current. That is, the peak signal voltage applied to each grid is not greater than the negative grid-bias voltage. The grids therefore are not driven to a positive potential and do not draw current. In class AB<sub>2</sub>, the peak signal voltage is greater than the bias so that the grids are driven positive and draw current.

Because of the flow of grid current in a class AB<sub>2</sub> stage, there is a loss of

power in the grid circuit. The sum of this loss and the loss in the input transformer is the total driving power required by the grid circuit. The driver stage should be capable of a power output considerably larger than this required power in order that distortion introduced in the grid circuit be kept low. The input transformer used in a class  $AB_2$  amplifier usually has a step-down turns ratio.

Because of the large fluctuations of plate current in a class  $AB_2$  stage, it is important that the plate power supply have good regulation. Otherwise the fluctuations in plate current cause fluctuations in the voltage output of the power supply, with the result that power output is decreased and distortion is increased. To obtain satisfactory regulation, it is usually advisable to use a low-drop rectifier, such as the 5V4GA, with a choke-input filter. In all cases, the resistance of the choke and transformers should be as low as possible.

**Class  $AB_1$  Power Amplifiers**

In class  $AB_1$  push-pull amplifier service using triodes, the operating conditions may be determined graphically by means of the plate family if  $E_o$ , the desired operating plate voltage, is given. In this service, the dynamic load line does not pass through the operating point P as in the case of the single-tube amplifier, but through the

point D in Fig. 25. Its position is not affected by the operating grid bias provided the plate-to-plate load resistance remains constant.

Under these conditions, grid bias has no appreciable effect on the power output. Grid bias cannot be neglected, however, since it is used to find the zero-signal plate current and, from it, the zero-signal plate dissipation. Because the grid bias is higher in class  $AB_1$  than in class A service for the same plate voltage, a higher signal voltage may be used without grid current being drawn and, therefore, higher power output is obtained.

In general, for any load line through point D, Fig. 25, the plate-to-plate load resistance in ohms of a push-pull amplifier is  $R_{pp} = 4E_o/I'$ , where  $I'$  is the plate-current value in amperes at which the load line as projected intersects the plate-current axis, and  $E_o$  is in volts. This formula is another form of the one given under push-pull class A amplifiers,  $R_{pp} = 4(E_o - 0.6E_o)/I_{max}$ , but is more general. Power output =  $(I_{max}/\sqrt{2})^2 \times R_{pp}/4$ , where  $I_{max}$  is the peak plate current at zero grid volts for the load chosen. This formula simplified is  $(I_{max})^2 \times R_{pp}/8$ . The maximum-signal average plate current is  $2I_{max}/\pi$  or  $0.636 I_{max}$ ; the maximum-signal average power input is  $0.636 I_{max} \times E_o$ .

It is desirable to simplify these

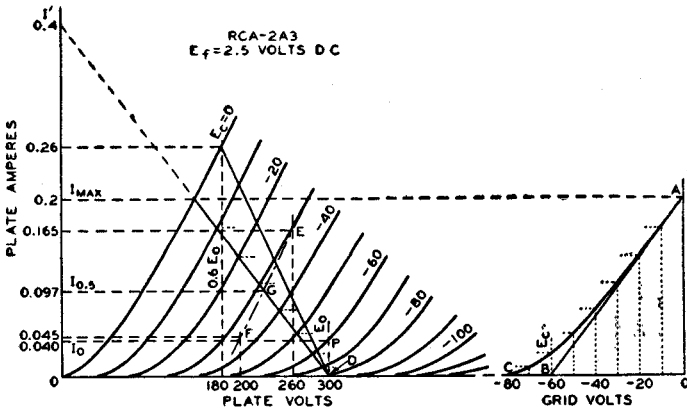

Fig. 25—Graphic calculations for class  $AB_1$  amplifier using the 2A3 power triode.

Fig. 26—Instantaneous curve for class  $AB_1$  amplifier.

formulas for a first approximation. This simplification can be made if it is assumed that the peak plate current,  $I_{\max}$ , occurs at the point of the zero-bias curve corresponding approximately to 0.6  $E_o$ , the condition for maximum power output. The simplified formulas are:

$$P_o \text{ (for two tubes)} = (I_{\max} \times E_o)/5$$

$$R_{pp} = 1.6E_o/I_{\max}$$

where  $E_o$  is in volts,  $I_{\max}$  is in amperes,  $R_{pp}$  is in ohms, and  $P_o$  is in watts.

It may be found during subsequent calculations that the distortion or the plate dissipation is excessive for this approximation; in that case, a different load resistance must be selected, using the first approximation as a guide, and the process repeated to obtain satisfactory operating conditions.

**Example:** Fig. 25 illustrates the application of this method to a pair of 2A3's operated at  $E_o = 300$  volts. Each tube has a plate-dissipation rating of 15 watts. The method is to erect a vertical line at  $0.6E_o$ , or at 180 volts, which intersects the  $E_o = 0$  curve at the point  $I_{\max} = 0.26$  ampere. Using the simplified formulas, the following values are obtained:

$$R_{pp} = (1.6 \times 300)/0.26 = 1845 \text{ ohms}$$

$$P_o = (0.26 \times 300)/5 = 15.6 \text{ watts}$$

At this point, it is well to determine the plate dissipation and to compare it with the maximum rated value. From the average-plate-current formula ( $0.636 I_{\max}$ ) mentioned previously, the maximum-signal average plate current is 0.166 ampere. The product of this current and the operating plate voltage is 49.8 watts, the average input to the two tubes. From this value, subtract the power output of 15.6 watts to obtain the total dissipation for both tubes, which is 34.2 watts. Half of this value, 17 watts, is in excess of the 15-watt rating of the tube and it is necessary, therefore, to assume another and higher load resistance so that the plate-dissipation rating will not be exceeded.

It will be found that at an operating plate voltage of 300 volts the 2A3's require a plate-to-plate load resistance of 3000 ohms. From the formula for  $R_{pp}$ , the value of  $I'$  is found to be 0.4

ampere. The load line for the 3000-ohm load resistance is then represented by a straight line from the point  $I' = 0.4$  ampere on the plate-current ordinate to the point  $E_o = 300$  volts on the plate-voltage abscissa. At the intersection of the load line with the zero-bias curve, the peak plate current,  $I_{\max}$ , can be read at 0.2 ampere. Then

$$P_o = (I_{\max}/\sqrt{2})^2 \times R_{pp}/4$$

$$= (0.2/1.41)^2 \times 3000/4$$

$$= 15 \text{ watts}$$

Proceeding as in the first approximation, it is found that the maximum-signal average plate current,  $0.636I_{\max}$ , is 0.127 ampere, and the maximum-signal average power input is 38.1 watts. This input minus the power output is  $38.1 - 15 = 23.1$  watts. This value is the dissipation for two tubes; the value per tube is 11.6 watts, a value well within the rating of this tube type.

The operating bias and the zero-signal plate current may then be found by use of a curve which is derived from the plate family and the load line. Fig. 26 is a curve of instantaneous values of plate current and dc grid-bias voltages taken from Fig. 25. Values of grid bias are read from each of the grid-bias curves of Fig. 25 along the load line and are transferred to Fig. 26 to produce the curved line from A to C. A tangent to this curve, starting at A, is drawn to intersect the grid-voltage abscissa. The point of intersection, B, is the operating grid bias for fixed-bias operation. In the example, the bias is  $-60$  volts. Refer back to the plate family at the operating conditions of plate volts = 300 and grid bias =  $-60$  volts; the zero-signal plate current per tube is seen to be 0.04 ampere.

This procedure locates the operating point for each tube at P. The plate current must be doubled, of course, to obtain the zero-signal plate current for both tubes. Under maximum-signal conditions, the signal voltage swings from zero-signal bias voltage to zero bias for each tube on alternate half cycles. Hence, in the example, the peak of signal voltage per tube is 60 volts, or the grid-to-grid value is 120 volts.

As in the case of the push-pull class A amplifier, the second-harmonic dis-

tortion in a class  $AB_1$  amplifier using triodes is very small and is largely canceled by virtue of the push-pull connection. Third-harmonic distortion, however, which may be larger than permissible, can be found by means of composite characteristic curves. A complete family of curves can be plotted, but for the present purpose only the one corresponding to a grid bias of one-half the peak grid-voltage swing is needed. In the example, the peak grid voltage per tube is 60 volts, and the half value is 30 volts. The composite curve, since it is nearly a straight line, can be constructed with only two points (see Fig. 25. These two points are obtained from deviations above and below the operating grid and plate voltages.

In order to find the curve for a bias of  $-30$  volts, a deviation of 30 volts from the operating grid voltage of  $-60$  volts is assumed. Next assume a deviation from the operating plate voltage of, say, 40 volts. Then at  $300 - 40 = 260$  volts, erect a vertical line to intersect the  $(-60) - (-30) = -30$ -volt bias curve and read the plate current at this intersection, which is 0.167 ampere; likewise, at the intersection of a vertical line at  $300 + 40 = 340$  volts and the  $(-60) + (-30) = -90$ -volt bias curve, read the plate current. In this example, the plate current is estimated to be 0.002 ampere. The difference of 0.165 ampere between these two currents determines the point E on the  $300 - 40 = 260$ -volt vertical. Similarly, another point F on the same composite curve is found by assuming the same grid-bias deviation but a larger plate-voltage deviation, say, 100 volts.

These steps provide points at 260 volts and 0.165 ampere (E), and at 200 volts and 0.045 ampere (F). A straight line through these points is the composite curve for a bias of  $-30$  volts, shown as a long-short dash line in Fig. 25. At the intersection of the composite curve and the load line, G, the instantaneous composite plate current at the point of one-half the peak signal swing is determined. This current value, designated  $I_{o.s}$  and the peak plate current,  $I_{max}$ , are used in the following formula

to find the peak value of the third-harmonic component of the plate current.

$$I_{h3} = (2I_{o.s} - I_{max})/3$$

In the example, where  $I_{o.s}$  is 0.097 ampere and  $I_{max}$  is 0.2 ampere,  $I_{h3} = (2 \times 0.097 - 0.2)/3 = (0.194 - 0.2)/3 = -0.006/3 = -0.002$  ampere. (The fact that  $I_{h3}$  is negative indicates that the phase relation of the fundamental (first-harmonic) and third-harmonic components of the plate current is such as to result in a slightly peaked wave form.  $I_{h3}$  is positive in some cases, indicating a flattening of the wave form.)

The peak value of the fundamental or first-harmonic component of the plate current is found by the following formula:

$$I_{h1} = 2/3 \times (I_{max} + I_{o.s})$$

In the example,  $I_{h1} = 2/3 \times (0.2 + 0.097) = 0.198$  ampere. Thus, the percentage of third-harmonic distortion is  $(I_{h3}/I_{h1}) \times 100 = (0.002/0.198) \times 100 = 1$  per cent approx.

### Class $AB_2$ Power Amplifiers

A class  $AB_2$  amplifier employs two tubes connected in push-pull as in the case of class  $AB_1$  amplifiers. It differs in that it is biased so that plate current flows for somewhat more than half the electrical cycle but less than the full cycle, the peak signal voltage is greater than the dc bias voltage, grid current is drawn, and, consequently, power is consumed in the grid circuit. These conditions permit high power output to be obtained without excessive plate dissipation.

The sum of the power used in the grid circuit and the losses in the input transformer is the total driving power required by the grid circuit. The driver stage should be capable of a power output considerably larger than this required power in order that distortion introduced in the grid circuit be kept low. In addition, the internal impedance of the driver stage as reflected into or as effective in the grid circuit of the power stage should always be as low as possible in order that distortion may be kept low. The input transformer used

in a class AB<sub>2</sub> stage usually has a step-down ratio adjusted for this condition.

Load resistance, plate dissipation, power output, and distortion determinations are similar to those for class AB<sub>1</sub>. These quantities are interdependent with peak grid-voltage swing and driving power; a satisfactory set of operating conditions involves a series of approximations. The load resistance and signal swing are limited by the permissible grid current and power and the distortion. If the load resistance is too high or the signal swing is excessive, the plate-dissipation rating will be exceeded, distortion will be high, and the driving power will be unnecessarily high.

#### *Class B Power Amplifiers*

A class B amplifier employs two tubes connected in push-pull, so biased that plate current is almost zero when no signal voltage is applied to the grids. Because of this low value of no-signal plate current, class B amplification has the same advantage as class AB<sub>2</sub>, *i.e.*, large power output can be obtained without excessive plate dissipation. Class B operation differs from class AB<sub>2</sub> in that plate current is cut off for a larger portion of the negative grid swing, and the signal swing is usually larger than in class AB<sub>2</sub> operation.

Because certain triodes used as class B amplifiers are designed to operate very close to zero bias, the grid of each tube is at a positive potential during all or most of the positive half-cycle of its signal swing. In this type of triode operation, considerable grid current is drawn and there is a loss of power in the grid circuit. This condition imposes the same requirement in the driver stage as in a class AB<sub>2</sub> stage; *i.e.*, the driver should be capable of delivering considerably more power output than the power required for the grid circuit of the class B amplifier so that distortion will be low. Similarly, the interstage transformer between the driver and the class B stage usually has a step-down turns ratio. Because of the high dissipations involved in class B operation at zero bias, it is not feasible to use tetrodes or pentodes in this type of class B operation.

Determination of load resistance, plate dissipation, power output, and distortion is similar to that for a class AB<sub>1</sub> stage.

Power amplifier tubes designed for class A operation can be used in class AB<sub>2</sub> and class B service under suitable operating conditions. There are several tube types designed especially for class B service. The characteristic common to all of these types is a high amplification factor. With a high amplification factor, plate current is small even when the grid bias is zero. These tubes, therefore, can be operated in class B service at a bias of zero volts so that no bias supply is required. A number of class B amplifier tubes consist of two triode units mounted in one tube. The two units can be connected in push-pull so that only one tube is required for a class B stage.

#### *High-Fidelity Amplifiers*

Several high-fidelity amplifiers are shown in the **Circuits** section. The performance capabilities of such amplifiers are usually given in terms of frequency response, total harmonic distortion, maximum power output, and noise level.

To provide high-fidelity reproduction of audio program material, an amplifier should have a frequency response which does not vary more than 1 db over the entire audio spectrum. General practice is to design the amplifier so that its frequency response is flat within 1 db from a frequency below the lowest to be reproduced to one well above the upper limit of the audible region.

Harmonic distortion and intermodulation distortion produce changes in program material which may have adverse effects on the quality of the reproduced sound. **Harmonic distortion** causes a change in the character of an individual tone by the introduction of harmonics which were not originally present in the program material. For high-fidelity reproduction, total harmonic distortion (expressed as a percentage of the output power) should not be greater than about 1 per cent at the

desired listening level. Types such as the 6973, 7027A and 7868 are designed to provide extremely low harmonic distortion in suitably designed push-pull amplifier circuits.

**Intermodulation distortion** is a change in the waveform of an individual tone as a result of interaction with another tone present at the same time in the program material. This type of distortion not only alters the character of the modulated tone, but may also result in the generation of spurious signals at frequencies equal to the sum and difference of the interacting frequencies. Intermodulation distortion should be less than 2 per cent at the desired listening level. In general, any amplifier which has low intermodulation distortion will have very low harmonic distortion.

The maximum power output which a high-fidelity amplifier should deliver depends upon a complex relation of several factors, including the size and acoustical characteristics of the listening area, the desired listening level, and the efficiency of the loudspeaker system. Practically, however, it is possible to determine amplifier requirements in terms of room size and loudspeaker efficiency.

The acoustic power required to reproduce the loudest passages of orchestral music at concert-hall level in the average-size living room is about 0.4 watt. Because high-fidelity loudspeakers of the type generally available for home use have an efficiency of only about 5 per cent, the output stage of the amplifier should therefore be able to deliver a power output of at least 8 watts. Because many wide-range loudspeaker systems, particularly those using frequency-divider networks, have efficiencies of less than 5 per cent, output tubes used with such systems must have correspondingly larger power outputs. The 6973, 7027A, 7189, and 7868 can provide ample output for most systems when used in suitable push-pull circuits.

The noise level of a high-fidelity amplifier determines the range of volume the amplifier is able to reproduce, *i.e.*, the difference (usually expressed in decibels) between the loudest

and softest sounds in program material. Because the greatest volume range utilized in electrical program material at the present time is about 60 dB, the noise level of a high-fidelity amplifier should be at least 60 dB below the signal level at the desired listening level.

### Cathode-Drive Circuits

The preceding text has discussed the use of tubes in the conventional **grid-drive** type of amplifier—that is, where the cathode is common to both the input and output circuits. Tubes may also be employed as amplifiers in circuit arrangements which utilize the grid or plate as the common terminal. Probably the most important of these amplifiers are the cathode-drive circuit, which is discussed below, and the cathode-follower circuit, which will be discussed later in connection with inverse feedback.

A typical **cathode-drive** circuit is shown in Fig. 27. The load is placed in

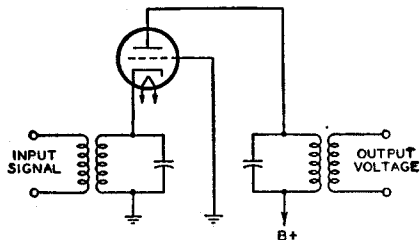

Fig. 27—Cathode-drive circuit.

the plate circuit and the output voltage is taken off between the plate and ground as in the grid-drive method of operation. The grid is grounded, and the input voltage is applied across an appropriate impedance in the cathode circuit. The cathode-drive circuit is particularly useful for vhf and uhf applications, in which it is necessary to obtain the low-noise performance usually associated with a triode, but where a conventional grid-drive circuit would be unstable because of feedback through the grid-to-plate capacitance of the tube. In the cathode-drive circuit, the grounded grid serves as a capacitive shield between plate and cathode and

permits stable operation at frequencies higher than those in which conventional circuits can be used.

The input impedance of a cathode-drive circuit is approximately equal to  $1/g_m$  when the load resistance is small compared to the  $r_p$  of the tube. A certain amount of power is required, therefore, to drive such a circuit. However, in the type of service in which cathode-drive circuits are normally used, the advantages of the grounded-grid connection usually outweigh this disadvantage.

### Inverse Feedback

An inverse-feedback circuit, sometimes called a **degenerative circuit**, is one in which a portion of the output voltage of a tube is applied to the input of the same or a preceding tube in opposite phase to the signal applied to the tube. Two important advantages of feedback are (1) reduced distortion from each stage included in the feedback circuit and (2) reduction in the variations in gain due to changes in line voltage, possible differences between tubes of the same type, or variations in the values of circuit constants included in the feedback circuit.

Inverse feedback is used in audio amplifiers to reduce distortion in the output stage where the load impedance on the tube is a loudspeaker. Because the impedance of a loudspeaker is not constant for all audio frequencies, the load impedance on the output tube varies with frequency. When the output tube is a pentode or beam power tube having high plate resistance, this variation in plate load impedance can, if not corrected, produce considerable frequency distortion. Such frequency distortion can be reduced by means of inverse feedback. Inverse-feedback circuits are of the **constant-voltage** type and the **constant-current** type.

The application of the **constant-voltage** type of inverse feedback to a power-output stage using a single beam power tube is illustrated in Fig. 28. In this circuit,  $R_1$ ,  $R_2$ , and  $C$  are connected as a voltage divider across the output of the tube. The secondary winding of the grid-input transformer is returned to a

point on this voltage divider. Capacitor  $C$  blocks the dc plate voltage from the grid. However, a portion of the tube af output voltage, approximately equal to the output voltage multiplied by the

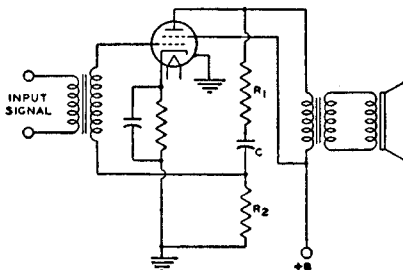

Fig. 28—Power-output stage using constant-voltage inverse feedback.

fraction  $R_2/(R_1 + R_2)$ , is applied to the grid. This voltage reduces the source impedance of the circuit and a decrease in distortion results which is explained in the curves of Fig. 29.

Consider first the amplifier without the use of inverse feedback. Suppose that when a signal voltage  $e_s$  is applied to the grid the af plate current  $i'_p$  has an irregularity in its positive half-cycle. This irregularity represents a departure from the waveform of the input signal and is, therefore, distortion. For this plate-current waveform, the af plate voltage has a waveform shown by  $e'_p$ . The plate-voltage waveform is inverted compared to the plate-current waveform because a plate-current increase produces an increase in the drop across the plate load. The voltage at the plate is the difference between the drop across the load and the supply voltage; thus, when plate current goes up, plate voltage goes down; when plate current goes down, plate voltage goes up.

Now suppose that inverse feedback is applied to the amplifier. The voltage fed back to the grid has the same waveform and phase as the plate voltage, but is smaller in magnitude. Hence, with a plate voltage of waveform shown by  $e'_p$ , the feedback voltage appearing on the grid is as shown by  $e'_{gr}$ . This voltage applied to the grid produces a component of plate current  $i'_{p,r}$ . It is evident that the irregularity in the waveform of



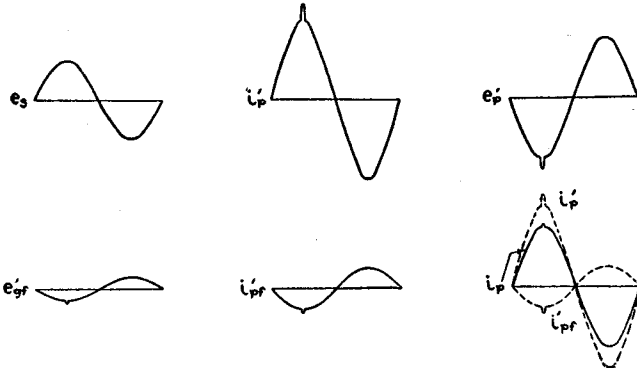

Fig. 29—Voltage and current waveforms showing effect of inverse feedback.

this component of plate current would act to cancel the original irregularity and thus reduce distortion.

After inverse feedback has been applied, the relations are as shown in the curve for  $i_p$ . The dotted curve shown by  $i_{pf}'$  is the component of plate current due to the feedback voltage on the grid. The dotted curve shown by  $i_p'$  is the component of plate current due to the signal voltage on the grid. The algebraic sum of these two components gives the resultant plate current shown by the solid curve of  $i_p$ . Since  $i_p'$  is the plate current that would flow without inverse feedback, it can be seen that the application of inverse feedback has reduced the irregularity in the output current. In this manner inverse feedback acts to correct any component of plate current that does not correspond to the input signal voltage, and thus reduces distortion.

From the curve for  $i_p$ , it can be seen that, besides reducing distortion, inverse feedback also reduces the amplitude of the output current. Consequently, when inverse feedback is applied to an amplifier there is a decrease in gain or power sensitivity as well as a decrease in distortion. Hence, the application of inverse feedback to an amplifier requires that more driving voltage be applied to obtain full power output, but this output is obtained with less distortion.

Inverse feedback may also be applied to resistance-coupled stages, as

shown in Fig. 30. The circuit is conventional except that a feedback resistor,  $R_a$ , is connected between the plates of tubes  $T_1$  and  $T_2$ . The output signal voltage of  $T_1$  and a portion of the output signal voltage of  $T_2$  appear across  $R_a$ . Because the distortion generated in the plate circuit of  $T_2$  is applied to its grid out of phase with the input signal, the distortion in the output of  $T_2$  is comparatively low. With sufficient inverse feedback of the constant-voltage type

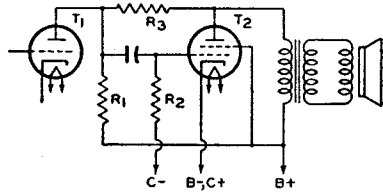

Fig. 30—Resistance-coupled stages using feedback resistor.

in a power-output stage, it is not necessary to employ a network of resistance and capacitance in the output circuit to reduce response at high audio frequencies. Inverse-feedback circuits can also be applied to push-pull class A and class  $AB_1$  amplifiers.

**Constant-current** inverse feedback is usually obtained by omitting the bypass capacitor across a cathode resistor. This method decreases the gain and the distortion but increases the source impedance of the circuit. Consequently, the output voltage rises at the resonant

frequency of the loudspeaker and accentuates hangover effects.

Inverse feedback is not generally applied to a triode power amplifier, such as the 2A3, because the variation in speaker impedance with frequency does not produce much distortion in a triode stage having low plate resistance. It is sometimes applied in a pentode stage, but is not always convenient. As has been shown, when inverse feedback is used in an amplifier, the driving voltage must be increased in order to provide full power output. When inverse feedback is used with a pentode, the total driving voltage required for full power output may be inconveniently large, although still less than that required for a triode. Because a beam power tube gives full power output on a comparatively small driving voltage, inverse feedback is especially applicable to beam power tubes. By means of inverse feedback, the high efficiency and high power output of beam power tubes can be combined with freedom from the effects of varying speaker impedance.

### Cathode-Follower Circuits

Another important application of inverse feedback is in the cathode-follower circuit, an example of which is shown in Fig. 31. In this application, the load has been transferred from the plate circuit to the cathode circuit of the tube.

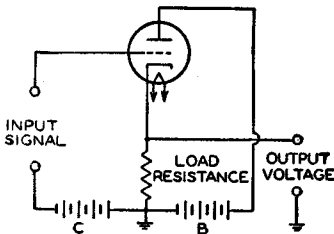

Fig. 31—Cathode-follower circuit.

The input voltage is applied between the grid and ground, and the output voltage is obtained between the cathode and ground. The voltage amplification (V.A.) of this circuit is always less than unity and may be expressed by the following convenient formulas.

For a triode:

$$V. A. = \frac{\mu \times R_L}{r_p + [R_L \times (\mu + 1)]}$$

For a pentode:

$$V. A. = \frac{g_m \times R_L}{1 + (g_m \times R_L)}$$

In these formulas,  $\mu$  is the amplification factor,  $R_L$  is the load resistance in ohms,  $r_p$  is the plate resistance in ohms, and  $g_m$  is the transconductance in mhos.

The use of the cathode follower permits the design of circuits which have high input resistance and high output voltage. The output impedance is quite low and very low distortion may be obtained. Cathode-follower circuits may be used for power amplifiers or as impedance transformers designed either to match a transmission line or to produce a relatively high output voltage at a low impedance level.

In a power amplifier which is transformer coupled to the load, the same output power can be obtained from the tube as would be obtained in a conventional grid-drive type of amplifier. The output impedance is very low and provides excellent damping to the load, with the result that very low distortion can be obtained. The peak-to-peak signal voltage, however, approaches  $1\frac{1}{2}$  times the plate supply voltage if maximum power output is required from the tube. Some problems may be encountered, therefore, in the design of an adequate driver stage for a cathode-follower output system.

When a cathode-follower circuit is used as an impedance transformer, the load is usually a simple resistance in the cathode circuit of the tube. With relatively low values of cathode resistor, the circuit may be designed to supply significant amounts of power and to match the impedance of the device to a transmission line. With somewhat higher values of cathode resistor, the circuit may be used to decrease the output impedance sufficiently to permit the transmission of audio signals along a line in which appreciable capacitance is present.

The cathode follower may also be used as an isolation device to provide extremely high input resistance and low

input capacitance as might be required in the probe of an oscilloscope or vacuum-tube voltmeter. Such circuits can be designed to provide effective impedance transformation with no significant loss of voltage.

Selection of a suitable tube and its operating conditions for use in a cathode-follower circuit having a specified output impedance ( $Z_o$ ) can be made, in most practical cases, by the use of the following formula to determine the approximate value of the required tube transconductance.

$$\text{Required } g_m (\mu\text{mhos}) = \frac{1,000,000}{Z_o (\text{ohms})}$$

Once the required transconductance is obtained, a suitable tube and its operating conditions may be determined from the technical data given in the **Technical Data** section. The tube selected should have a value of transconductance slightly lower than that obtained from the above expression to allow for the shunting effect of the cathode load resistance. The conversion nomograph given in Fig. 24 may be used for calculation of operating conditions for values of transconductance not included in the tabulated data. After the operating conditions have been determined, the approximate value of the required cathode load resistance may be calculated from the following formulas. For a triode:

$$\text{Cathode } R_L = \frac{Z_o \times r_p}{r_p - [Z_o \times (1 + \mu)]}$$

For a pentode:

$$\text{Cathode } R_L = \frac{Z_o}{1 - (g_m \times Z_o)}$$

Resistance and impedance values are in ohms; transconductance values are in mhos.

If the value of the cathode load resistance calculated to provide the required output impedance does not provide the required operating bias, the basic cathode-follower circuit can be modified in a number of ways. Two of the more common modifications are shown in Figs. 32 and 33.

In Fig. 32 the bias is increased by adding a bypassed resistance between the cathode and the unbypassed load resistance and returning the grid to the low end of the load resistance. In Fig.

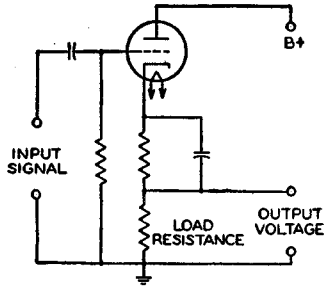

Fig. 32—Cathode-follower circuit modified for increased bias.

33 the bias is reduced by adding a bypassed resistance between the cathode and the unbypassed load resistance but, in this case, the grid is returned to the junction of the two cathode resistors so that the bias voltage is only the dc voltage drop across the added resistance. The size of the bypass capacitor should be large enough so that it has negligible reactance at the lowest frequency to be handled. In both cases the B-supply should be increased to make up for the voltage taken for biasing.

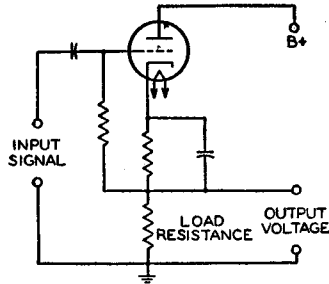

Fig. 33—Cathode-follower circuit modified for reduced bias.

**Example:** Select a suitable tube and determine the operating conditions and circuit components for a cathode-follower circuit having an output impedance that will match a 500-ohm transmission line.

**Procedure:** First, determine the approximate transconductance required.

$$\text{Required } g_m = \frac{1,000,000}{500} = 2000 \mu\text{mhos}$$

A survey of the tubes that have a transconductance in this order of magnitude shows that type 12AX7A is among

the tubes to be considered. Referring to the characteristics given in the technical data section for one triode unit of high- $\mu$  twin triode 12AX7, we find that for a plate voltage of 250 volts and a bias of  $-2$  volts, the transconductance is 1600 micromhos, the plate resistance is 62500 ohms, the amplification factor is 100, and the plate current is 0.0012 ampere. When these values are used in the expression for determining the cathode load resistance, the following result is obtained:

$$\text{Cathode } R_L = \frac{500 \times 62500}{62500 - 500 \times (100 + 1)} = 2600 \text{ ohms}$$

The voltage across this resistor for a plate current of 0.0012 ampere is  $2600 \times 0.0012 = 3.12$  volts. Because the required bias voltage is only  $-2$  volts, the circuit arrangement given in Fig. 33 is employed. The bias is furnished by a resistance that will have a voltage drop of 2 volts when it carries a current of 0.0012 ampere. The required bias resistance, therefore, is  $2/0.0012 = 1670$  ohms. If 60 cycles per second is the lowest frequency to be passed, 20 microfarads is a suitable value for the bypass capacitor. The B-supply, of course, is increased by the voltage drop across the cathode resistance which, in this example, is approximately 5 volts. The B-supply, therefore, is  $250 + 5 = 255$  volts.

Because it is desirable to eliminate, if possible, the bias resistor and bypass capacitor, it is worthwhile to try other tubes and other operating conditions to obtain a value of cathode load resistance which will also provide the required bias. If the triode section of twin diode—high- $\mu$  triode 6AT6 is operated under the conditions given in the technical data section with a plate voltage of 100 volts and a bias of  $-1$  volt, it will have an amplification factor of 70, a plate resistance of 54000 ohms, a transconductance of 1300 micromhos, and a plate current of 0.0008 ampere. Then,

$$\text{Cathode } R_L = \frac{500 \times 54000}{54000 - 500 \times (70 + 1)} = 1460 \text{ ohms}$$

The bias voltage obtained across this resistance is  $1460 \times 0.0008 = 1.17$  volts. Since this value is for all practical purposes close enough to the required bias, no addition bias resistance will be required and the grid may be returned directly to ground. There is no need to adjust the B-supply voltage to make up for the drop in the cathode resistor. The voltage amplification (V.A.) for the cathode-follower circuit utilizing the triode section of type 6AT6 is

$$\text{V.A.} = \frac{70 \times 1460}{54000 + 1460 \times (70 + 1)} = 0.65$$

For applications in which the cathode follower is used to isolate two circuits—for example, when it is used between a circuit being tested and the input stage of an oscilloscope or a vacuum-tube voltmeter—voltage output and not impedance matching is the primary consideration. In such applications it is desirable to use a relatively high value of cathode load resistance, such as 50,000 ohms, in order to get the maximum voltage output. In order to obtain proper bias, a circuit such as that of Fig. 33 should be used. With a high value of cathode resistance, the voltage amplification will approximate unity.

### Corrective Filters

A corrective filter can be used to improve the frequency characteristic of an output stage using a beam power tube or a pentode when inverse feedback is not applicable. The filter consists of a resistor and a capacitor connected in series across the primary of the output transformer. Connected in this way, the filter is in parallel with the plate load impedance reflected from the voice-coil by the output transformer. The magnitude of this reflected impedance increases with increasing frequency in the middle and upper audio range. The impedance of the filter, however, decreases with increasing frequency. It follows that, by use of the proper values for the resistance and the capacitance in the filter, the effective load impedance on the output tubes can be made practically constant for all frequencies in

the middle and upper audio range. The result is an improvement in the frequency characteristic of the output stage.

The resistance to be used in the filter for a push-pull stage is 1.3 times the recommended plate-to-plate load resistance; or, for a single-tube stage, is 1.3 times the recommended plate load resistance. The capacitance in the filter should have a value such that the voltage gain of the output stage at a frequency of 1000 cycles or higher is equal to the voltage gain at 400 cycles.

A method of determining the proper value of capacitance for the filter is to make two measurements of the output voltage across the primary of the output transformer: first, when a 400-cycle signal is applied to the input, and second, when a 1000-cycle signal of the same voltage as the 400-cycle signal is applied to the input. The correct value of capacitance is the one which gives equal output voltages for the two signal inputs. In practice, this value is usually found to be in the order of 0.05 microfarad.

### Volume Compressors and Expanders

Volume compression and expansion are used in FM transmitters and receivers and in recording devices and amplifiers to make more natural the reproduction of music which has a very large volume range. For example, in the music of a symphony orchestra the sound intensity of the soft passages is very much lower than that of the loud passages. When this low volume level is raised above the background noise for transmitting or recording, the peak level of the program material may be raised to an excessively high volume level. It is often necessary, therefore, to compress the volume range of the program content within the maximum capabilities of the FM transmitter or the recording device. Exceeding a maximum peak volume level for FM modulation corresponds to exceeding the allowed bandwidth for transmission. In some recording devices, excessive peak volume levels may cause overloading and distortion.

Volume compression may be accomplished by either manual or automatic control. The types of compression used include peak limiters, volume limiters, and volume compressors. A peak limiter limits the peak power to some predetermined level. A volume limiter provides gain reduction based on an average signal level above a predetermined level. A volume compressor provides gain reduction for only the sustained loud portions of the sound level. Only volume compressors can be correctly compensated for with volume expanders.

For faithful reproduction of the original sound, the volume expander used in the FM receiver or audio amplifier should have the reverse characteristic of the volume compressor used in the FM transmitter or recording device. In general, the basic requirements for either a volume compressor or expander are shown in the block diagram of Fig. 34. In a volume compressor, the

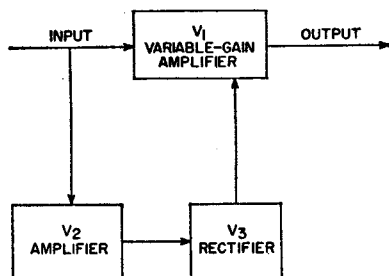

Fig. 34—Block diagram of volume compressor or expander circuit.

variable-gain amplifier  $V_1$  has greater gain for a low-amplitude signal than for a high-amplitude signal; therefore, soft passages are amplified more than loud ones. In an expander, the gain is greater for high-amplitude signals than for low-amplitude signals; therefore, loud passages are amplified more than soft ones and the original amplitude ratio is restored.

In the diagram shown in Fig. 34, the signal to be amplified is applied to  $V_1$ , and a portion of the signal is also applied to  $V_2$ . The amplified output

from  $V_2$  is then rectified by  $V_3$ , and applied as a negative (for compressors) or positive (for expanders) bias voltage to  $V_1$ . As this bias voltage varies with variations in signal amplitude, the gain of  $V_1$  also varies to produce the desired compression or expansion of the signal.

Tubes having a large dynamic range provide the best results in volume compressor or expander applications. Examples of such types are the 6BJ6 and 6BE6. Push-pull operation is generally desired for the variable-gain amplifier to prevent high distortion and other undesirable effects which may occur in volume compressors and expanders.

### Phase Inverters

A phase inverter is a circuit used to provide resistance coupling between the output of a signal-tube stage and the input of a push-pull stage. The necessity for a phase inverter arises because the signal-voltage inputs to the grids of a push-pull stage must be 180 degrees out of phase and approximately equal in amplitude with respect to each other. Thus, when the signal voltage input to a push-pull stage swings the grid of one tube in a positive direction, it should swing the grid of the other tube in a negative direction by a similar amount. With transformer coupling between stages, the out-of-phase input voltage to the push-pull stage is supplied by means of the center-tapped secondary. With resistance coupling, the out-of-phase input voltage is obtained by means of the inverter action of a tube.

Fig. 35 shows a push-pull power amplifier, resistance-coupled by means of a phase-inverter circuit to a single-stage triode  $T_1$ . Phase inversion in this circuit is provided by triode  $T_2$ . The output voltage of  $T_1$  is applied to the grid of triode  $T_3$ . A portion of the output voltage of  $T_1$  is also applied through the resistors  $R_3$  and  $R_5$  to the grid of  $T_2$ . The output voltage of  $T_2$  is applied to the grid of triode  $T_4$ .

When the output voltage of  $T_1$  swings in the positive direction, the

plate current of  $T_2$  increases. This action increases the voltage drop across the plate resistor  $R_2$  and swings the plate of  $T_2$  in the negative direction. Thus, when the output voltage of  $T_1$  swings positive, the output voltage of  $T_2$  swings negative and is, therefore, 180 degrees out of phase with the output voltage of  $T_1$ .

In order to obtain equal voltages at  $E_a$  and  $E_b$ ,  $(R_3 + R_5)/R_5$  should equal the voltage gain of  $T_2$ . Under the condition where a twin-type tube or two tubes having the same characteristics are used as  $T_1$  and  $T_2$ ,  $R_4$  should be equal to the sum of  $R_3$  and  $R_5$ . The ratio of  $R_3 + R_4$  to  $R_5$  should be the same as the voltage gain ratio of  $T_2$  in order to apply the correct value of signal voltage to  $T_2$ . The value of  $R_5$  is, therefore, equal to  $R_4$  divided by the voltage gain of  $T_2$ ;  $R_3$  is equal to  $R_4$  minus  $R_5$ . Values of  $R_1$ ,  $R_2$ ,  $R_3$  plus  $R_5$ , and  $R_4$  may be taken from the chart in the **Resistance-Coupled Amplifiers** section. In the practical application of this circuit, it is convenient to use a twin-triode tube combining  $T_1$  and  $T_2$ .

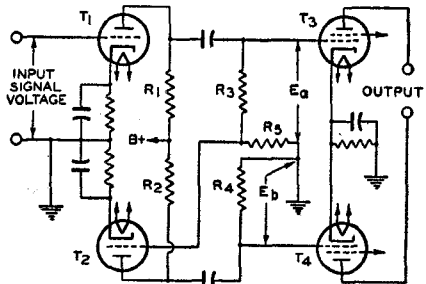

Fig. 35—Push-pull power amplifier resistance-coupled to triode by means of phase inverter.

### Tone Controls

A tone control is a variable filter (or one in which at least one element is adjustable) by means of which the user may vary the frequency response of an amplifier to suit his own taste. In radio receivers and home amplifiers, the tone control usually consists of a resistance-capacitance network in which the resistance is the variable element.

The simplest form of tone control

is a fixed tone-compensating or "equalizing" network such as that shown in Fig. 36. This type of network is often used to equalize the low- and high-frequency response of a crystal phonograph pickup. At low frequencies the attenuation of this network is 20.8 dB. As the frequency is increased, the 100-picofarad capacitor serves as a bypass for the 5-megohm resistor, and the combined impedance of the resistor-capacitor network is reduced. Thus,

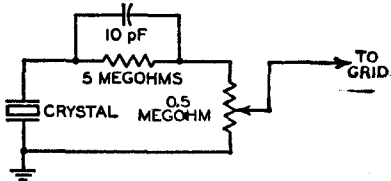

Fig. 36—Tone-control circuit for fixed tone compensation or "equalizing".

more of the crystal output appears across the 0.5-megohm resistor at high frequencies than at low frequencies, and the frequency response at the grid is reasonably flat over a wide frequency range. Fig. 37 shows a comparison between the output of the crystal (curve A) and the output of the equalizing network (curve B). The response curve can be "flattened" still more if the attenuation at low frequencies is increased by changing the 0.5-megohm resistor to 0.125 megohm.

The tone-control network shown in Fig. 38 has two stages with completely separate bass and treble controls. Fig. 39 shows simplified representations of

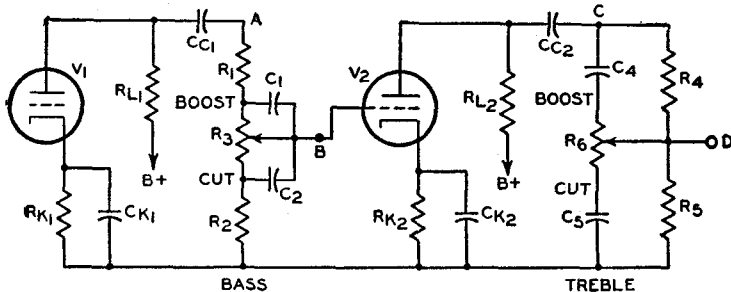

Fig. 38—Two-stage tone-control circuit incorporating separate bass and treble controls.

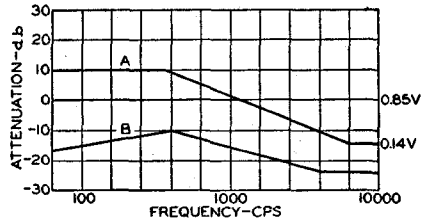

Fig. 37—Curve showing output from crystal phonograph pickup (A) and from equalizing network (B).

the bass control of this circuit when the potentiometer is turned to its extreme variations (usually labeled "Boost" and "Cut"). In this network, as in the crystal-equalizing network shown in Fig. 36, the parallel RC combination is the controlling factor. For bass "boost," the capacitor  $C_2$  bypasses resistor  $R_3$  so that less impedance is placed across the output to grid B at high frequencies than

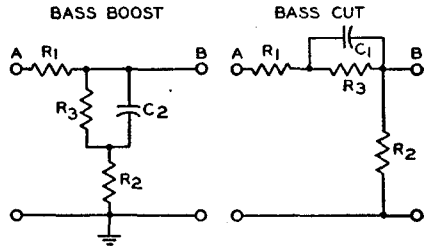

Fig. 39—Simplified representations of bass-control circuit at extreme ends of potentiometer.

at low frequencies. For bass "cut," the parallel combination is shifted so that  $C_1$  bypasses  $R_3$ , causing more high-

frequency than low-frequency output. Essentially, the network is a variable-frequency voltage divider. With proper values for the components, it may be made to respond to changes in the  $R_3$  potentiometer setting for only low frequencies (below 1000 cycles).

Fig 40 shows extreme positions of the treble control. The attenuation of the two circuits is approximately the same at 1000 cycles. The treble "boost" circuit is similar to the crystal-equalizing network shown in Fig. 36. In the treble "cut" circuit, the parallel RC elements serve to attenuate the signal voltage further because the capacitor bypasses the resistance across the output.

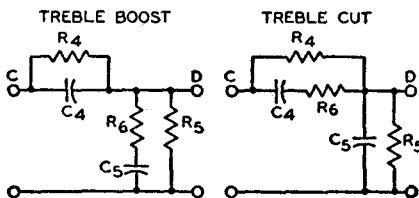

Fig. 40—Simplified representations of treble-control circuit at extreme ends of potentiometer.

The effect of the capacitor is negligible at low frequencies; beyond 1000 cycles, the signal voltage is attenuated at a maximum rate of 6 dB per octave.

The location of a tone-control network is of considerable importance. In a typical radio receiver, it may be inserted in the plate circuit of the power tube, the coupling circuit between the first af amplifier tube and the power tube, or the grid circuit of the first tube. In an amplifier using a beam power tube or pentode power amplifier without negative feedback, it is desirable to connect a resistance-capacitance filter across the primary of the output transformer. This filter may be fixed, with a supplementary tone control elsewhere, or it may form the tone control itself. If the amplifier incorporates negative feedback, the tone control may be inserted in the feedback network or else should be connected to a part of the amplifier which is external to the feedback loop. The over-

all gain of a well designed tone-control network should be approximately unity.

### Phonograph and Tape Preamplifiers

The frequency range and dynamic range which can be recorded on a phonograph record or on magnetic tape depend on several factors, including the composition, mechanical characteristics, and speed of the record or tape, and the electrical and mechanical characteristics of the recording equipment. To achieve wide frequency and dynamic ranges, manufacturers of commercial recordings use equipment which introduces a nonuniform relationship between amplitude and frequency. This relationship is known as a "recording characteristic." To assure proper reproduction of a high-fidelity recording, therefore, some part of the reproducing system must have a frequency-response characteristic which is the inverse of the recording characteristic. Most manufacturers of high-fidelity recordings use the RCA "New Orthophonic" (RIAA) characteristic for discs and the NARTB characteristic for magnetic tape.

Some typical preamplifier stages are shown in the **Circuits** section. The location of the frequency-compensating network or "equalizer" in the reproducing system will depend on the types of recordings which are to be reproduced and on the pickup devices used.

A ceramic high-fidelity phonograph pickup is usually designed to provide proper compensation for the RIAA recording characteristic when the pickup is operated into the load resistance specified by its manufacturer. Because this type of pickup also has relatively high output (0.5 to 1.5 volts), it does not require the use of either an equalizer network or a preamplifier, and can be connected directly to the input of a tone-control amplifier and/or power amplifier.

A magnetic high-fidelity phonograph pickup, on the other hand, usually has an essentially flat frequency-response characteristic and very low output (1 to 10 millivolts). Because a pickup of this type merely reproduces the recording characteristic, it must be



followed by an equalizer network, as well as by a preamplifier having sufficient voltage gain to provide the input voltage required by the tone-control amplifier and/or power amplifier. Many designs include both the equalizing and amplifying circuits in a single unit.

A high-fidelity magnetic-tape pickup head, like a magnetic phonograph pickup, reproduces the recording characteristic and has an output of only a few millivolts. This type of pickup device, therefore, must also be followed by an equalizing network and preamplifier, or by a preamplifier which provides "built-in" equalization for the NARTB characteristic.

### Limiters

An amplifier may also be used as a limiter. One use of a limiter is in receivers designed for the reception of frequency-modulated signals. The limiter in FM receivers has the function of eliminating amplitude variations from the input to the detector. Because in an FM system amplitude variations are primarily the result of noise disturbances, the use of a limiter prevents such disturbances from being reproduced in the audio output. The limiter usually follows the last if stage so that it can minimize the effects of disturbances coming in on the rf carrier and those produced locally.

The limiter is essentially an if voltage amplifier designed for saturated operation. Saturated operation means that an increase in signal voltage above a certain value produces very little increase in plate current. A signal voltage which is never less than sufficient to cause saturation of the limiter, even on weak signals, is supplied to the limiter input by the preceding stages. Any change in amplitude, therefore, such as might be produced by noise voltage fluctuation, is not reproduced in the limiter output. The limiting action, of course, does not interfere with the reproduction of frequency variations.

Plate-current saturation of the limiter may be obtained by the use of grid-No. 1-resistor-and-capacitor bias with plate and grid-No. 2 voltages which are low compared with customary if-amplifier operating conditions.

As a result of these design features, the limiter is able to maintain its output voltage at a constant amplitude over a wide range of input-signal voltage variations. The output of the limiter is frequency-modulated if voltage, the mean frequency of which is that of the if amplifier. This voltage is impressed on the input of the detector.

The reception of FM signals without serious distortion requires that the response of the receiver be such that satisfactory amplification of the signal is provided over the entire range of frequency deviation from the mean frequency. Since the frequency at any instant depends on the modulation at that instant, it follows that excessive attenuation toward the edges of the band, in the rf or if stages, will cause distortion. In a high-fidelity receiver, therefore, the amplifiers must be capable of amplifying, for the maximum permissible frequency deviation of 75 kilocycles, a band 150 kilocycles wide. Suitable tubes for this purpose are the 6BA6 and 6BJ6.

### Television Tuners

The vhf tuner of a television receiver selects the desired frequency channel in the range from 55 to 216 megacycles per second, amplifies it, and converts it to a lower intermediate frequency. These functions are accomplished in rf-amplifier, mixer, and local-oscillator stages employing tube types that are designed specifically for these applications. The rf-amplifier stage uses a high-transconductance tube that has small dimensions to maintain low interelectrode capacitances, particularly between grid and plate. The mixer and oscillator stages usually employ a dual-unit triode-pentode tube that has a high-transconductance pentode unit and a medium-mu triode unit.

Fig. 41 shows a simplified schematic diagram of a typical vhf television tuner. The balun converts the 300-ohm balanced antenna impedance to an unbalanced impedance of 75 ohms. The high-pass filter eliminates lower-frequency interference signals. The tuner is set to the desired frequency by simultaneous adjustment of the inductances

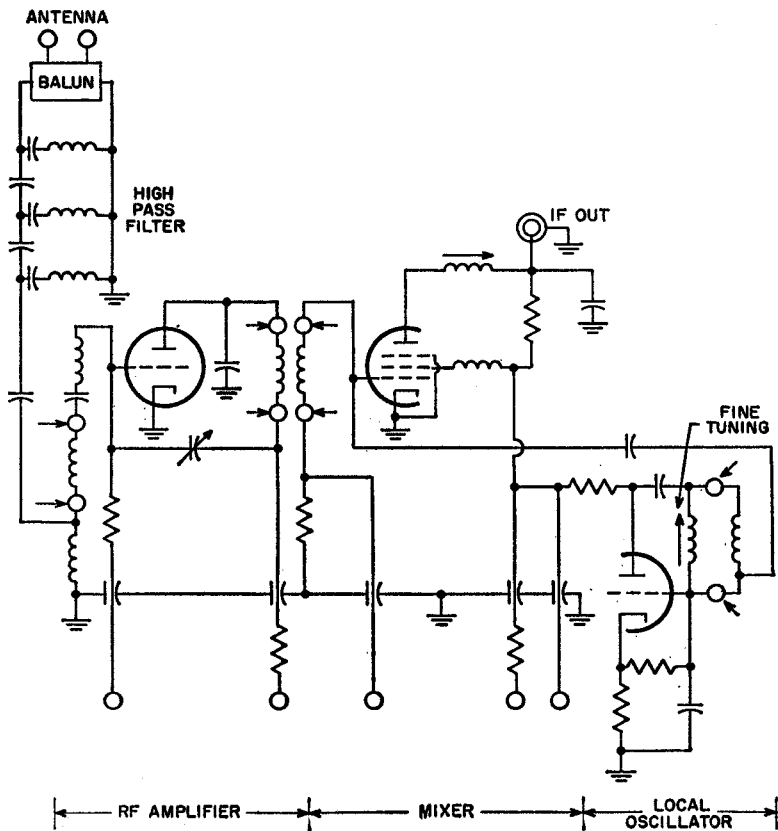

Fig. 41—Simplified schematic of typical vhf television tuner.

indicated by the several sets of arrows in Fig. 41. The inductances are either replaced completely or incremental amounts of inductance are added as the tuner is switched from high frequencies to lower frequencies. Some tuners use a combination of the two methods.

Because **noise** generated in the first amplifier stage is often the controlling factor in determining the over-all sensitivity of a radio or television receiver, the "front end" is designed with special attention to both gain and noise characteristics. The input circuit of an amplifier inherently contains some thermal noise contributed by the resistive elements in the input device. When an

input signal is amplified, therefore, the thermal noise generated in the input circuit is also amplified. If the ratio of signal power to noise power (**signal-to-noise ratio, S/N**) is the same in the output circuit as in the input circuit, the amplifier is considered to be "noiseless," and is said to have a noise figure of unity, or zero dB.

In practical circuits, however, all amplifier stages generate a certain amount of noise as a result of thermal agitation of electrons in resistors and other components, minute variations in the cathode emission of tubes (shot effect), and minute grid currents in the amplifier tubes. As a result, the ratio of signal power to noise power is in-

evitably impaired during amplification. A measure of the degree of impairment is called the **noise figure** (NF) of the amplifier, and is expressed as the ratio of signal power to noise power at the input ( $S_i/N_i$ ) divided by the ratio of signal power to noise power at the output ( $S_o/N_o$ ), as follows:

$$NF = \frac{(S_i/N_i)}{(S_o/N_o)}$$

The noise figure in decibels (dB) is equal to ten times the logarithm of this power ratio. For example, a one-dB noise figure in an amplifier decreases the signal-to-noise ratio by a factor of 1.26, a 3-dB noise figure by a factor of 2, a 10-dB noise figure by a factor of 10, and a 20-dB noise figure by a factor of 100.

The over-all noise figure of a receiver is affected by the total number of stages, as shown by the following relationship:

$$NF_{\text{receiver}} = NF_1 + \frac{(NF_2 + 1)}{G_1} + \frac{(NF_3 + 1)}{G_1 G_2} \dots$$

where G represents power gain and the subscripts indicate the number of each stage. This relationship indicates that the contribution of the second-stage noise factor to that of the over-all receiver is reduced by the gain of the first stage. Therefore, it is important that the rf amplifier have enough gain to make the effect of the second stage negligible. The third stage will then have even less effect. The maximum available power gain G of an rf stage is given by

$$G = \frac{g_m^2 R_{in} R_{out}}{4}$$

For maximum gain, therefore, the rf-amplifier tube should have high transconductance and high input and output impedances. At frequencies in the vhf television band, the input resistance is small enough to affect the gain. As mentioned previously, the rf tube is designed to have low interelectrode capacitances, small interelectrode spacings, and low lead inductances (particularly the cathode lead).

The gain of the rf stage must be

reduced as the incoming-signal amplitude changes to prevent overload distortion in the following stages. As the signal amplitude increases, an automatic-gain-control (agc) circuit biases the rf tube to decrease its gain. The rf tube usually employs a semiremote-cutoff grid to reduce cross-modulation distortion.

Either a triode or a pentode can be used in the **rf-amplifier** stage of tuner input circuits of vhf television receivers. Such stages are required to amplify signals ranging from 55 to 216 megacycles per second and having a bandwidth of 4.5 megacycles per second (the tuner is usually aligned for a bandwidth of 6 megacycles per second to assure complete coverage of the band). In early rf tuners, pentodes rather than triodes were used because the grid-plate capacitance of triodes created stability problems. However, the use of twin triodes in direct-coupled cathode-drive circuits makes it possible to obtain stable operation along with the low-noise characteristics of triodes.

Pentodes or tetrodes do not provide the useful sensitivity of triodes because of the "partition noise" introduced by the screen grid. The direct-coupled cathode-drive circuit provides both the gain and the stability capabilities of the pentode, as well as the advantages of a low-noise triode input stage. Because the cathode-drive stage provides a low-impedance load to the grounded-cathode stage, the gain of the latter stage is very low and there is no necessity for neutralizing the grid-plate capacitance. An interstage impedance, usually an inductance in series with the plate of the first stage and the cathode of the second stage, is often used at higher frequencies to provide a degree of impedance matching between the units. The cathode-drive portion of the circuit is matched to the input network and provides most of the stage gain. Because the feedback path of the cathode-drive circuit is the plate-cathode capacitance, which in most cases is very small, excellent isolation is provided between the antenna and the local oscillator.

Development of single triodes having low grid-plate capacitance, such as the 6BN4, has made possible the design of neutralized triode rf circuits. Tubes such as the 6GK5 and 6CW4 are specially designed to minimize grid-plate capacitance to permit easier neutralization of a grounded-cathode circuit over the wide frequency band. Bridge-neutralized rf-amplifier stages are widely used in television tuners; in this arrangement, a portion of the output signal is returned to the grid out of phase with the feedback signal from the grid-plate capacitance. This circuit provides excellent gain and noise performance with stable operation across the band.

The mixer stage of a vhf tuner usually employs a pentode tube, or the pentode unit of a triode-pentode tube. Although triodes such as the 6J6 were used as mixers in early receivers, they have been replaced by pentodes because the higher output impedance of a pentode provides a higher mixer gain than can be obtained with a triode.

The amplified signal from the rf stage in Fig. 41 is applied to the mixer grid along with a local-oscillator signal of much larger amplitude. The local-oscillator signal varies the mixer grid voltage from cutoff into the grid-current region. This signal develops a grid-resistor bias, called the **injection voltage**, which is a measure of the local-oscillator voltage. Because the transfer curve of the mixer tube is nonlinear, mixing action between the rf signal and the local-oscillator signal produces sum and difference frequencies. The output circuit of the mixer is tuned to the difference frequency (about 44 megacycles per second) and rejects all other frequencies. This signal is then fed to the intermediate-frequency amplifier.

The mixer gain is a function of the amplitude of the local-oscillator signal. The gain has a broad maximum over a range of injection voltages from  $-2.5$  to  $-5.0$  volts for conventional-grid mixers and slightly lower for frame-grid mixers. Good impedance matching between the rf-amplifier plate and the mixer grid, consistent with

bandpass requirements, is important to achieve maximum signal power transfer. A slight amount of regeneration is provided by a small screen-grid inductance. This regeneration effectively increases the mixer-grid input impedance and thus improves power gain.

The **local-oscillator** stage shown in Fig. 41 is a Colpitts type in which the tuned circuit is located between the grid and plate and the feedback path is through the tube interelectrode capacitances. A large signal is developed in the local oscillator and coupled loosely to the mixer grid to minimize the effects of changes in the mixer input on the frequency of oscillation. The circuit is designed to keep frequency shift within a very narrow range with supply-voltage and temperature changes. Fine tuning is provided by a variable inductance or capacitance across the tuned circuit. Tubes commonly used in local-oscillator and mixer circuits are the 6EA8, 6KZ8, and 6KE8.

### Television IF Amplifiers

The intermediate-frequency (if) amplifier stages in a television receiver provide the additional gain required to bring the signal level to an amplitude suitable for final detection. A constant peak signal of about three to five volts is required at the input to the detector. The mixer output signal is passed through two or three stages of amplification to attain this level. High-transconductance pentodes having low grid-No.1-to-plate capacitances are normally used in if amplifiers. The coupling circuits are usually tuned transformers which may be single- or double-tuned. The transformers are either synchronously (same frequency) tuned or stagger-tuned, depending on circuit requirements. The over-all bandwidth varies from a maximum of 3.58 megacycles per second at the 6-dB points for color receivers to values in the order of 2.0 to 2.5 megacycles per second for the most inexpensive receivers. An expression for the figure of merit for a single-tuned if-amplifier tube is the gain-bandwidth product  $G \times B$ , which is

given by

$$G \times B = \frac{g_m}{2\pi C}$$

where C is the total tuning capacitance. This relationship again demonstrates the need for high transconductance and low interelectrode capacitance.

The first stage (or first two stages in the case of a three-stage if) is gain-controlled like the rf amplifier. However, the bias applied to the if-amplifier tube varies the input resistance and capacitance of the tube and thus detunes the circuit. It is important for proper reception to maintain the frequency response of the if stages constant, particularly in the case of the color receiver. Therefore, a small unbypassed cathode resistor is used which provides degenerative feedback to minimize the effect of bias changes. In addition, the effects on input impedance caused by the grid-plate capacitance are reduced by use of a partial bypass capacitor at the screen grid to provide neutralization of the grid-to-plate capacitance.

Tubes used in the gain-controlled stages of the if amplifier have remote- or semiremote-cutoff characteristics to reduce cross-modulation or intermodulation interference. Tube types commonly used in this application include the 6BZ6, 6GM6, 6JH6, and 6JD6.

The last if-amplifier stage is a relatively-large-signal amplifier. For this reason, the tube must be biased so that it will operate over a region of linear operation for large voltage excursions. Because such a quiescent operating point provides a transconductance somewhat below the maximum value for the tube, the selection of the operating point involves a compromise between signal-handling capacity and gain. For purposes of linearity, the final if-amplifier stage is not gain-controlled, and operates with the cathode bypassed to ground. Because fixed bias is used, a sharp-cutoff tube is used to provide higher transconductance than could be obtained with an equivalent remote- or semiremote-cutoff tube. Ex-

amples of types used in this stage are the 6EW6 and 6JC6.

### Video Amplifiers

The video amplifier stage in a television receiver usually employs a pentode-type tube specially designed to amplify the wide band of frequencies contained in the video signal and, at the same time, to provide high gain per stage. Pentodes are more useful than triodes in such stages because they have high transconductance (to provide high gain) together with low input and output interelectrode capacitances (to permit the broadband requirements to be satisfied). An approximate "figure of merit" for a particular tube for this application can be determined from the ratio of its transconductance,  $g_m$ , to the sum of its input and output capacitances,  $C_{in}$  and  $C_{out}$ , as follows:

$$\text{Figure of Merit} = \frac{g_m}{C_{in} + C_{out}}$$

Typical values for this figure are in the order of  $500 \times 10^6$  or greater.

A typical video amplifier stage, such as that shown in Fig. 42, is connected between the second detector of the television receiver and the picture tube. The contrast control,  $R_1$ , in this circuit controls the gain of the video amplifier tube. The inductance,  $L_2$ , in series with the load resistor,  $R_L$ , maintains the plate load impedance at a relatively constant value with increasing

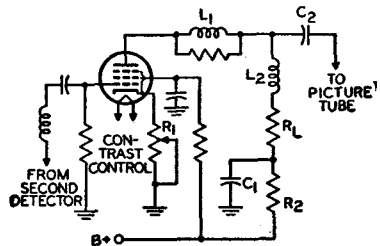

Fig. 42—Typical video amplifier stage.

frequency. The inductance  $L_2$  isolates the output capacitance of the tube so that only stray capacitance is placed

across the load. As a result, a higher-value load resistor is used to provide higher gain without affecting frequency response or phase relations. The decoupling circuit,  $C_1R_2$ , is used to improve the low-frequency response. Tubes used as video amplifiers include types 6CL6 and 12BY7A, or the pentode sections of types 6AW8A and 6AN8A.

The **luminance amplifier** in a color-television receiver is a conventional video amplifier having a bandwidth of approximately 3.5 megacycles per second. In a color receiver, the portion of the output of the second detector which lies within the frequency band from approximately 2.4 to 4.5 megacycles per second is fed to a bandpass amplifier, as shown in the block diagram in Fig. 43. The color synchronizing signal, or "burst," contained in this signal may then be fed to a "burst-keyer" tube. At the same time, a delayed horizontal pulse may be applied to the keyer tube. The output of the keyer tube is applied to the burst amplifier tube and the

The output of the 3.58-megacycle oscillator and the output of the bandpass amplifier are fed into phase and amplitude demodulator circuits. The output of each demodulator circuit is an electrical representation of a color-difference signal, *i.e.*, an actual color signal minus the black-and-white, or luminance, signal. The two color-difference signals are combined to produce the third color-difference signal; each of the three signals then represents one of the primary colors.

The three color-difference signals are usually applied to the grids of the three electron guns of the color picture tube, in which case the black-and-white signal from the luminance amplifier may be applied simultaneously to the cathodes. The chrominance and luminance signals then combine to produce the color picture. In the absence of transmitted color information, the chrominance channel is cut off by the color killer, as described above, and only the luminance signal is applied to the picture tube, producing a black-and-white picture.

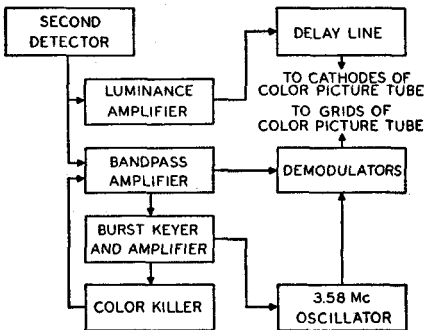

Fig. 43—Block diagram of video-amplifier section of color television receiver.

signal is then fed to the 3.58-megacycle oscillator and to the "color-killer" stage.

The color killer applies a bias voltage to the bandpass amplifier in the absence of burst so that the color section, or **chrominance** channel, of the receiver remains inoperative during black-and-white broadcasts. A threshold control varies the bias and controls the burst level at which the killer stage operates.

### Television Sync Circuits

In addition to picture information, the composite video signal supplied to a television receiver contains information to assure that the picture produced on the receiver is synchronized with the picture being viewed by the camera or pickup tube. The "sync" pulses, which have a greater amplitude than the video signal, trigger the scanning generators of the receiver when the electron beam of the pickup tube ends each trace.

The sync pulses in the composite video signal may be separated from the video information in the output of the second or video detector by means of the triode circuit shown in Fig. 44. In this circuit, the time constant of the network  $R_1C_1$  is long with respect to the interval between pulses. During each pulse, the grid is driven positive and draws current, thereby charging capacitor  $C_1$ . Consequently, the grid develops a bias which is slightly greater

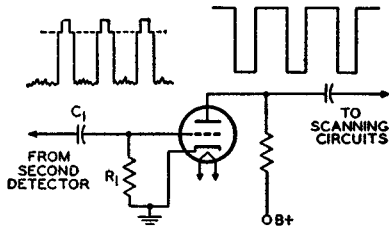

Fig. 44—Sync-separator circuit.

than the cutoff voltage of the tube. Because plate current flows only during the sync-pulse period, only the amplified pulse appears in the output. This sync-separator stage discriminates against the video information. Because the bias developed on the grid is proportional to the strength of the incoming signal, the circuit also has the advantage of being relatively independent of signal fluctuations.

Because the electron beam scans the face of the picture tube at different rates in the vertical and horizontal directions, the receiver incorporates two different scanning generators. The repetition rate of the vertical generator is 60 cycles per second, and the rate of the horizontal generator is approximately 15,750 cycles per second. The composite video signal includes information which enables each generator to derive its correct triggering. One horizontal sync pulse is supplied at the end of each horizontal line scan. At the end of each frame, several pulses of longer duration than the horizontal sync pulses are supplied to actuate the vertical generator. The vertical information is separated from the horizontal information by differentiating and integrating circuits.

In fringe areas, two conditions complicate the process of sync separation. First, the incoming signal available at the antenna is weak and susceptible to fading and other variations; second, the receiver is operating at or near maximum gain, which makes it extremely susceptible to interference from pulse-type noise generated by certain types of electrical equipment, ignition systems, switches, or the like. Some type of noise-immunity provision is

almost essential for acceptable performance. Noise may be reduced or eliminated from the sync and agc circuits by gating or by a combination of gating, inversion, and cancellation. An example, of the latter method is shown in Fig. 45. In this circuit the 6GY6, which has two independent control grids, serves the dual function of agc amplifier and noise inverter. Because the sync tips of the video signal at grid No. 1 of the 6GY6 drive the tube near its cutoff region, any noise signal

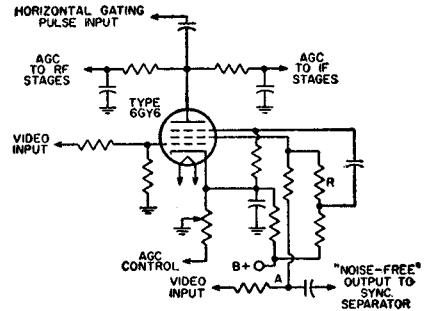

Fig. 45—Typical noise-cancellation circuit.

extending above the tip level will appear inverted across the grid-No.2 load resistor R. This inverted noise signal is re-combined with the video signal and fed to the sync separator at point "A" in Fig. 45, where noise cancellation takes place. This process leaves the sync pulses relatively free of disturbing noise and results in a stable picture. To prevent reduction of receiver gain due to the effect of noise on the agc amplifier, a portion of the inverted noise signal is fed to the second control grid, grid No.3, of the 6GY6 to cut off or gate the agc amplifier when a noise pulse occurs.

### Rectification

The rectifying action of a diode finds important applications in supplying a receiver with dc power from an ac line and in supplying high dc voltage from a high-voltage pulse. A typical arrangement for converting ac to dc includes a rectifier tube, a filter, and a voltage divider. The rectifying action of the tube is explained briefly under **Diodes**, in the **Electrons, Electrodes,**

and **Electron Tubes** section. High-voltage pulse rectification is described later under **Horizontal Output Circuits**.

The function of a filter is to smooth out the ripple of the tube output, as indicated in Fig. 46, and to increase rectifier efficiency. The action

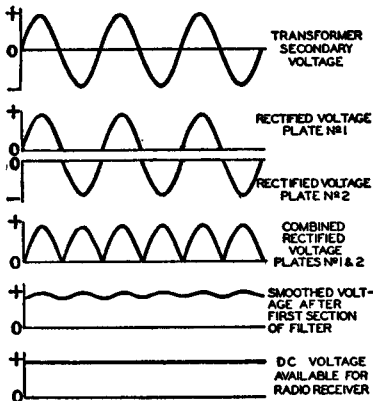

Fig. 46—Voltage waveforms of full-wave rectifier circuit.

of the filter is explained in the **Electron Tube Installation** section under **Filters**. The voltage divider is used to cut down the output voltage to the values required by the plates and the other electrodes of the tubes in the receiver.

A **half-wave rectifier** and a **full-wave rectifier** circuit are shown in Fig. 47. In the half-wave circuit, current flows through the rectifier tube to the filter on every other half-cycle of the ac input voltage when the plate is positive with respect to the cathode. In the full-wave circuit, current flows to the filter on every half-cycle, through plate No. 1 on one half-cycle when plate No. 1 is positive with respect to the cathode, and through plate No. 2 on the next half-cycle when plate No. 2 is positive with respect to the cathode.

Because the current flow to the filter is more uniform in the full-wave circuit than in the half-wave circuit, the output of the full-wave circuit requires less filtering. Rectifier operating information and circuits are given under each rectifier tube type and in the **Circuits** section, respectively.

**Parallel operation** of rectifier tubes furnishes an output current greater than that obtainable with the use of one tube. For example, when two full-wave rectifier tubes are connected in parallel, the plates of each tube are connected together and each tube acts as a half-wave rectifier. The permissible voltage and load conditions per tube are the same as for full-wave service but the total load-handling capability of the complete rectifier is approximately doubled.

When mercury-vapor rectifier tubes are connected in parallel, a stabilizing resistor of 50 to 100 ohms should be connected in series with each plate lead in order that each tube will carry an equal share of the load. The value of the resistor to be used will depend on the amount of plate current that passes through the rectifier. Low plate current requires a high value; high plate current, a low value. When the plates of mercury-vapor rectifier tubes are connected in parallel, the corresponding filament leads should be similarly connected. Otherwise, the tube drops will be considerably unbalanced and larger stabilizing resistors will be required.

Two or more vacuum rectifier tubes can also be connected in parallel

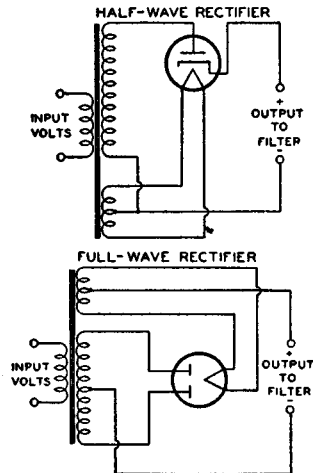

Fig. 47—Half-wave and full-wave rectifier circuits.



to give correspondingly higher output current and, as a result of paralleling their internal resistances, give somewhat increased voltage output. With vacuum types, stabilizing resistors may or may not be necessary depending on the tube type and the circuit.

A **voltage-doubler** circuit of simple form is shown in Fig. 48. The circuit derives its name from the fact that its

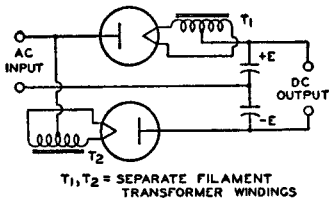

Fig. 48—Full-wave voltage-doubler circuit.

dc voltage output can be as high as twice the peak value of ac input. Basically, a voltage doubler is a rectifier circuit arranged so that the output voltages of two half-wave rectifiers are in series.

The action of a voltage doubler can be described briefly as follows. On the positive half-cycle of the ac input, that is, when the upper side of the ac input line is positive with respect to the lower side, the upper diode passes current and feeds a positive charge into the upper capacitor. As positive charge accumulates on the upper plate of the capacitor, a positive voltage builds up across the capacitor. On the next half-cycle of the ac input, when the upper side of the line is negative with respect to the lower side, the lower diode passes current so that

a negative voltage builds up across the lower capacitor.

So long as no current is drawn at the output terminals from the capacitor, each capacitor can charge up to a voltage of magnitude  $E$ , the peak value of the ac input. It can be seen from the diagram that with a voltage of  $+E$  on one capacitor and  $-E$  on the other, the total voltage across the capacitors is  $2E$ . Thus the voltage doubler supplies a no-load dc output voltage twice as large as the peak ac input voltage. When current is drawn at the output terminals by the load, the output voltage drops below  $2E$  by an amount that depends on the magnitude of the load current and the capacitance of the capacitors. The arrangement shown in Fig. 48 is called a full-wave voltage doubler because each rectifier passes current to the load on each half of the ac input cycle.

Two rectifier types especially designed for use as voltage doublers are the 25Z6GT and 117Z6GT. These tubes combine two separate diodes in one tube. As voltage doublers, the tubes are used in "transformerless" receivers. In these receivers, the heaters of all tubes in the set are connected in series with a voltage-dropping resistor across the line. The connections for the heater supply and the voltage-doubling circuit are shown in Fig. 49.

With the full-wave voltage-doubler circuit in Fig. 49, it will be noted that the dc load circuit can not be connected to ground or to one side of the ac supply line. This circuit presents certain disadvantages when the heaters of all the tubes in the set are connected in series

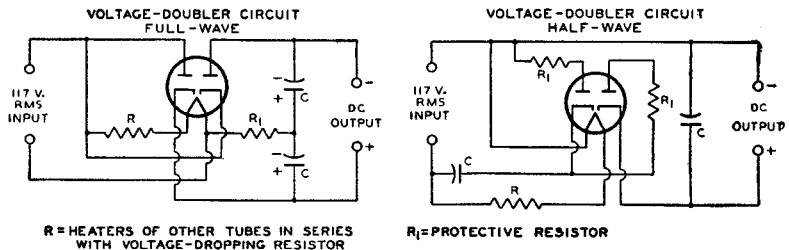

Fig. 49—Full-wave and half-wave voltage-doubler circuits showing heater-supply connections.

with a resistance across the ac line. Such a circuit arrangement may cause hum because of the high ac potential between the heaters and cathodes of the tubes.

The half-wave voltage-doubler circuit in Fig. 49 overcomes this difficulty by making one side of the ac line common with the negative side of the dc load circuit. In this circuit, one half of the tube is used to charge a capacitor which, on the following half cycle, discharges in series with the line voltage through the other half of the tube. This circuit is called a half-wave voltage doubler because rectified current flows to the load only on alternate halves of the ac input cycle. The voltage regulation of this arrangement is somewhat poorer than that of the full-wave voltage doubler.

### Detection

When speech, music, or video information is transmitted from a radio or television station, the station radiates a radio-frequency (rf) wave which is of either of two general types. In one type, the wave is said to be amplitude modulated when its frequency remains constant and the amplitude is varied. In the other type, the wave is said to be frequency modulated when its amplitude remains essentially constant but its frequency is varied.

The function of the receiver is to reproduce the original modulating wave from the modulated rf wave. The receiver stage in which this function is performed is called the **demodulator** or detector stage.

#### AM Detection

The effect of **amplitude modulation** on the waveform of the rf wave is shown in Fig. 50. There are three different basic circuits used for the detection

of amplitude-modulated waves: the diode detector, the grid-bias detector, and the grid-resistor detector. These circuits are alike in that they eliminate, either partially or completely, alternate half-cycles of the rf wave. With alternate half-cycles removed, the audio variations of the other half-cycles can be amplified to drive headphones or a loud-speaker.

A **diode-detector** circuit is shown in Fig. 51. The action of this circuit when a modulated rf wave is applied is

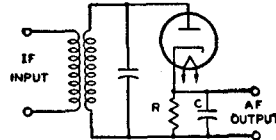

Fig. 51—Basic diode-detector circuit.

illustrated by Fig. 52. The rf voltage applied to the circuit is shown in light line; the output voltage across capacitor C is shown in heavy line.

Between points (a) and (b) on the first positive half-cycle of the applied rf voltage, capacitor C charges up to the peak value of the rf voltage. Then as the applied rf voltage falls away from its peak value, the capacitor holds the cathode at a potential more positive than the voltage applied to the anode. The capacitor thus temporarily cuts off current through the diode. While the diode current is cut off, the capacitor discharges from (b) to (c) through the diode load resistor R.

When the rf voltage on the anode rises high enough to exceed the potential at which the capacitor holds the cathode, current flows again and the capacitor charges up to the peak value of the second positive half-cycle at (d). In this way, the voltage across the capacitor follows the peak value of the applied rf

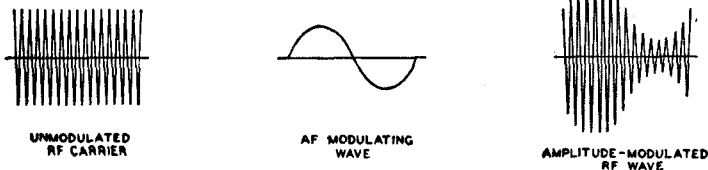

Fig. 50—Waveforms showing effect of amplitude modulation on an rf wave.

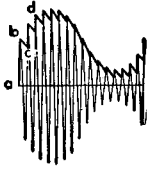

Fig. 52—Waveforms showing modulated rf input (light line) and output voltage (heavy line) of diode-detector circuit.

voltage and reproduces the af modulation.

The curve for voltage across the capacitor, as shown in Fig. 52, is somewhat jagged. However, this jaggedness, which represents an rf component in the voltage across the capacitor, is exaggerated in the drawing. In an actual circuit the rf component of the voltage across the capacitor is negligible. Hence, when the voltage across the capacitor is amplified, the output of the amplifier reproduces the speech or music originating at the transmitting station.

Another way to describe the action of a diode detector is to consider the circuit as a half-wave rectifier. When the rf signal on the plate swings positive, the tube conducts and the rectified current flows through the load resistance  $R$ . Because the dc output voltage of a rectifier depends on the voltage of the ac input, the dc voltage across  $C$  varies in accordance with the amplitude of the rf carrier and thus reproduces the af signal. Capacitor  $C$  should be large enough to smooth out rf or if variations, but should not be so large as to affect the audio variations. Two diodes can be connected in a circuit similar to a full-wave rectifier to provide full-wave detection. However, in practice, the advantages of this connection generally do not justify the extra circuit complication.

The diode method of detection produces less distortion than other methods because the dynamic characteristics of a diode can be made more linear than those of other detectors. The disadvantages of a diode are that it does not amplify the signal, and that it draws current from the input circuit and therefore reduces the selectivity of the input circuit. However, because the

diode method of detection produces less distortion and because it permits the use of simple avc circuits without the necessity for an additional voltage supply, the diode method of detection is most widely used in broadcast receivers.

A typical diode-detector circuit using a twin-diode—triode tube is shown in Fig. 53. Both diodes are connected

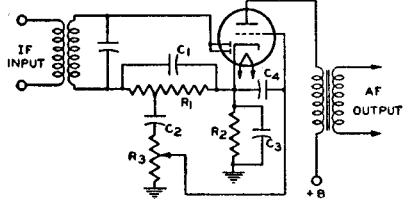

Fig. 53—Typical diode-detector circuit using a twin diode—triode tube.

together.  $R_1$  is the diode load resistor. A portion of the af voltage developed across this resistor is applied to the triode grid through the volume control  $R_s$ . In a typical circuit, resistor  $R_1$  may be tapped so that five-sixths of the total af voltage across  $R_1$  is applied to the volume control. This tapped connection reduces the af voltage output of the detector circuit slightly, but it reduces audio distortion and improves the rf filtering.

DC bias for the triode section is provided by the cathode-bias resistor  $R_2$  and the audio bypass capacitor  $C_2$ . The function of capacitor  $C_2$  is to block the dc bias of the cathode from the grid. The function of capacitor  $C_4$  is to bypass any rf voltage on the grid to cathode. A twin-diode—pentode may also be used in this circuit. With a pentode, the af output should be resistance-coupled rather than transformer-coupled.

Another diode-detector circuit, called a diode-biased circuit, is shown in Fig. 54. In this circuit, the triode grid

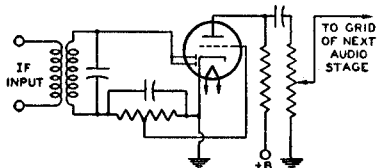

Fig. 54—Diode-biased detector circuit.

is connected directly to a tap on the diode load resistor. When an rf signal voltage is applied to the diode, the dc voltage at the tap supplies bias to the triode grid. When the rf signal is modulated, the af voltage at the tap is applied to the grid and is amplified by the triode.

The advantage of the circuit shown in Fig. 54 over the self-biased arrangement shown in Fig. 53 is that the diode-biased circuit does not employ a capacitor between the grid and the diode load resistor, and consequently does not produce as much distortion of a signal having a high percentage of modulation.

However, there are restrictions on the use of the diode-biased circuit. Because the bias voltage on the triode depends on the average amplitude of the rf voltage applied to the diode, the average amplitude of the voltage applied to the diode should be constant for all values of signal strength at the antenna. Otherwise there will be different values of bias on the triode grid for different signal strengths and the triode will produce distortion. Because there is no bias applied to the diode-biased triode when no rf voltage is applied to the diode, sufficient resistance should be included in the plate circuit of the triode to limit its zero-bias plate current to a safe value.

These restrictions mean, in practice, that the receiver should have a separate-channel automatic-volume-control (avc) system. With such an avc system, the average amplitude of the signal voltage applied to the diode can be held within very close limits for all values of signal strength at the antenna.

The tube used in a diode-biased circuit should be one which operates at a fairly large value of bias voltage. The variations in bias voltage are then a small percentage of the total bias and hence produce small distortion. Tubes taking a fairly large bias voltage are types such as the 6BF6 or 6SR7 having a medium- $\mu$  triode. Tube types having a high- $\mu$  triode or a pentode should not be used in a diode-biased circuit.

A **grid-bias detector** circuit is

shown in Fig. 55. In this circuit, the grid is biased almost to cutoff, *i.e.*, operated so that the plate current with zero signal is practically zero. The bias voltage can be obtained from a cathode-bias resistor, a C-battery, or a bleeder

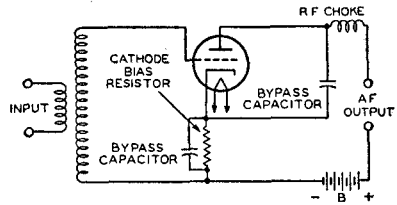

Fig. 55—Grid-bias detector circuit.

tap. Because of the high negative bias, only the positive half-cycles of the rf signal are amplified by the tube. The signal is, therefore, detected in the plate circuit. The advantages of this method of detection are that it amplifies the signal, besides detecting it, and that it does not draw current from the input circuit and therefore does not reduce the selectivity of the input circuit.

The **grid-resistor-and-capacitor method**, illustrated in Fig. 56, is somewhat more sensitive than the grid-bias method and gives its best results on weak signals. In this circuit, there is no negative dc bias voltage applied to the grid. Hence, on the positive half-cycles of the rf signal, current flows from grid to cathode. The grid and cathode thus

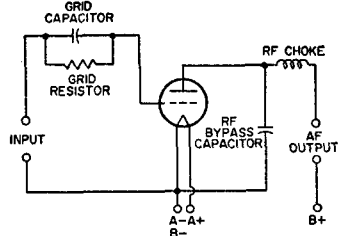

Fig. 56—Detector circuit using grid-resistor-and-capacitor bias.

act as a diode detector, with the grid resistor as the diode load resistor and the grid capacitor as the rf bypass capacitor. The voltage across the capacitor then reproduces the af modulation in the same manner as has been ex-

plained for the diode detector. This voltage appears between the grid and cathode and is therefore amplified in the plate circuit. The output voltage thus reproduces the original af signal.

In this detector circuit, the use of a high-resistance grid resistor increases selectivity and sensitivity. However, improved af response and stability are obtained with lower values of grid-circuit resistance. This detector circuit amplifies the signal, but draws current from the input circuit and therefore reduces the selectivity of the input circuit.

**FM Detection**

The effect of frequency modulation on the waveform of the rf wave is shown in Fig. 57. In this type of transmission, the frequency of the rf wave deviates from a mean value, at an rf rate depending on the modulation, by an amount that is determined in the transmitter and is proportional to the amplitude of the af modulation signal.

For this type of modulation, a detector is required to discriminate between deviations above and below the mean frequency and to translate those

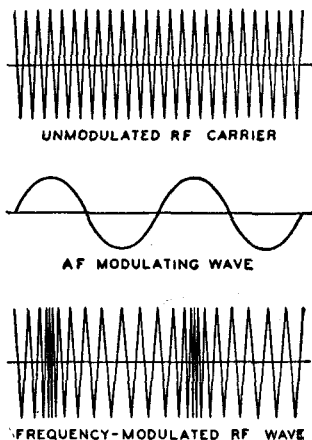

Fig. 57—Waveforms showing effect of frequency modulation on an rf wave.

deviations into a voltage whose amplitude varies at audio frequencies. Since the deviations occur at an audio fre-

quency, the process is one of demodulation, and the degree of frequency deviation determines the amplitude of the demodulated (af) voltage.

A simple circuit for converting frequency variations to amplitude variations is a circuit which is tuned so that the mean radio frequency is on one slope of its resonance characteristic, as at A of Fig. 58. With modulation, the frequency swings between B and C, and the voltage developed across the circuit varies at the modulating rate. In order that no distortion will be introduced in this circuit, the frequency swing must be restricted to the portion of the slope which is effectively straight. Since this portion is very short, the voltage developed is low. Because of these limitations, this circuit is not commonly used but it serves to illustrate the principle.

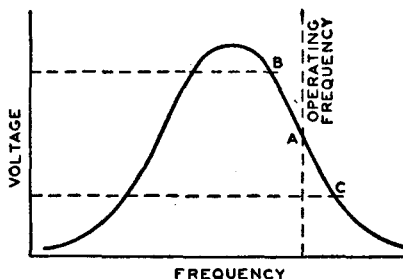

Fig. 58—Resonance curve showing desired operating range for frequency-modulation converter.

The faults of the simple circuit are overcome in a push-pull arrangement, sometimes called a **discriminator circuit**, such as that shown in Fig. 59. Because of the phase relationships between

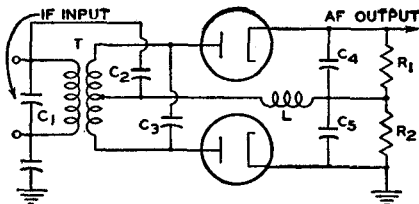

Fig. 59—Basic discriminator circuit.

the primary and each half of the secondary of the input transformer (each half of the secondary is connected in series with the primary through capacitor  $C_2$ ), the rf voltages applied to the diodes become unequal as the rf signal swings from the resonant frequency in each direction.

Because the swing occurs at audio frequencies (determined by the af modulation), the voltage developed across the diode load resistors,  $R_1$  and  $R_2$  connected in series, varies at audio frequencies. The output voltage depends on the difference in amplitude of the voltages developed across  $R_1$  and  $R_2$ . These voltages are equal and of opposite sign when the rf carrier is not modulated and the output is, therefore, zero. When modulation is applied, the output voltage varies as shown in Fig. 60.

Because this type of FM detector is sensitive to amplitude variations in the rf carrier, a limiter stage is frequently used to remove most of the amplitude modulation from the carrier. (See **Limiters** under **Amplification**.)

Another form of detector for frequency-modulated waves is called a **ratio detector**. This FM detector, unlike the previous one which responds to a difference in voltage, responds only to changes in the ratio of the voltage across two diodes and is, therefore, insensitive to changes in the differences in the voltages due to amplitude modulation of the rf carrier.

The basic ratio detector is given in Fig. 61. The plate load for the final af amplifier stage is the parallel resonant circuit consisting of  $C_1$  and the primary transformer T. The tuning and coupling of the transformer are practically the

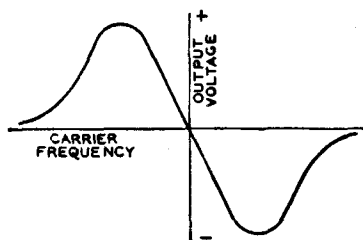

Fig. 60—Output waveform of discriminator circuit.

same as in the previous circuit and, therefore, the rf voltages applied to the diodes depend upon how much the rf signal swings from the resonant frequency in each direction. At this point the similarity ends.

Diode 1,  $R_2$ , and diode 2 complete a series circuit fed by the secondary of the transformer T. The two diodes are connected in series so that they conduct on the same rf half-cycle. The rectified current through  $R_2$  causes a negative voltage to appear at the plate of diode 1. Because  $C_3$  is large, this negative voltage at the plate of diode 1 remains constant even at the lowest audio frequencies to be reproduced.

The rectified voltage across  $C_3$  is proportional to the voltage across diode 1, and the rectified voltage across  $C_1$  is proportional to the voltage across diode 2. Because the voltages across the two diodes differ according to the instantaneous frequency of the carrier, the voltages across  $C_3$  and  $C_1$  differ proportionately, the voltage across  $C_3$  being the larger of the two voltages at carrier frequencies below the intermediate frequency and the smaller at frequencies above the intermediate frequency.

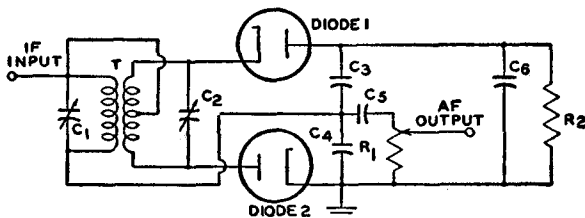

Fig. 61—Basic ratio-detector circuit.

These voltages across  $C_s$  and  $C_a$  are additive and their sum is fixed by the constant voltage across  $C_o$ . Therefore, while the ratio of these voltages varies at an audio rate, their sum is always constant. The voltage across  $C_a$  varies at an audio rate when a frequency-modulated rf carrier is applied to the ratio detector; this audio voltage is extracted and fed to the audio amplifier. For a complete circuit utilizing this type of detector, refer to the **Circuits** section.

**Color Demodulation**

In the transmission of picture signals for color-television receivers, all the color information is contained in three signals, a luminance (black-and-white) or monochrome signal and two chrominance signals. The luminance signal, which is called the Y signal, contains brightness information only. The voltage response of the Y signal is made similar to the brightness response of the human eye by use of a composite signal that contains definite proportions of the red, green, and blue signals from the color-television camera (30 per cent red, 59 per cent green, and 11 per cent blue). This Y signal, which includes sync and blanking pulses, provides a correct monochrome picture in a conventional black-and-white television receiver.

For the generation of color-television signals, the Y signal is subtracted from the red, green, and blue signals to provide a new set of color-difference signals, which are designated as R-Y, B-Y, and G-Y. All of the original picture information is contained in the Y

signal, the R-Y signal, and the B-Y signal. Therefore, the G-Y signal is not contained in the transmitted signal, but is synthesized in the receiver by proper combination of the R-Y and B-Y signals.

(Color signals transmitted under present color-television standards are not R-Y and B-Y, but a similar pair of signals designated as I and Q. In the color-television receiver, R-Y and B-Y signals are demodulated directly from the I and Q signals with negligible loss of color quality. For purposes of simplicity, only R-Y and B-Y signals are considered in this explanation. In addition, a 90-degree phase-shift network is shown; the phase-shift angle could be, and often is, some other value.)

Because the luminance signal and the two color-difference signals must be transmitted with a standard 6-megacycle channel, the two color signals are combined into one signal at the transmitter and are independently recovered at the receiver by proper detection techniques. A color subcarrier of approximately 3.58 megacycles per second is used for transmitting the color information within the 6-megacycle spectrum of the television station. As shown in Fig. 62, the 3.58-megacycle subcarrier and one of the color-difference signals are applied directly to a balanced AM modulator. The other color-difference signal is applied directly to a second balanced AM modulator, and the 3.58-megacycle subcarrier is applied to this second modulator through a 90-degree phase-shifting network. The balanced modulators effectively cancel both the individual color-

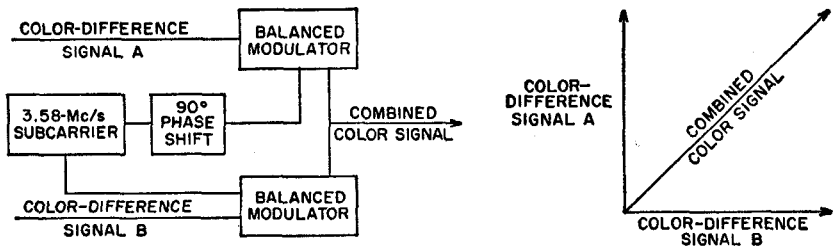

Fig. 62—Formation of combined color signal for transmission.

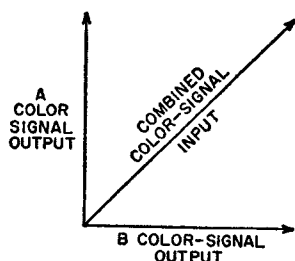

Fig. 63—Separation of combined color signal into two signals at the receiver.

difference signals and the subcarrier signal, and the output contains only the side-bands of the combined chrominance signal.

Recovery of the color information at the receiver involves a process called **synchronous detection**. In this process, two separate detectors are used to recover the separate color information, just as two separate modulators were used to combine the information at the transmitter. The 3.58-megacycle subcarrier, which was suppressed during transmission, must be reinserted at the receiver for recovery of the color information. The basis of synchronous detection is the phase relationship of this reinserted 3.58-megacycle subcarrier.

For example, the original color information is represented in Fig. 62 by the color-difference signals A and B. At the receiver, the combined color signal is fed to two demodulators A and B, as shown in Fig. 63. At the same time, a 3.58-megacycle subcarrier is also fed to the two demodulators, with the same phase relationship that was used in the modulators at the transmitter. This locally generated subcarrier essentially duplicates or replaces the original subcarrier, which was removed at the transmitter.

The local 3.58-megacycle oscillator in the color-television receiver is made to function at the proper frequency and phase by means of a synchronizing signal sent out by the transmitter. This synchronizing signal consists of a short **burst** of 3.58-megacycle signals transmitted during the horizontal blanking interval, immediately after the horizontal sync pulse, as shown in Fig. 64.

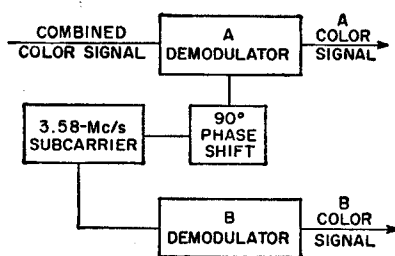

Fig. 65 shows a simplified diagram of a low-level color demodulator frequently used in color-television receivers. The locally generated 3.58-megacycle signal is applied to the grid No. 3

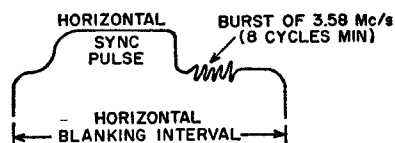

Fig. 64—Waveform for synchronizing signal.

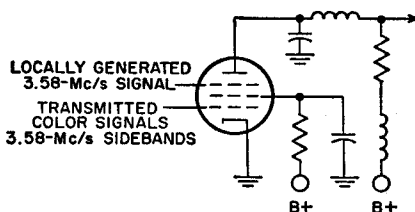

Fig. 65—Low-level color demodulator.

of the pentode. The transmitted color signal containing the 3.58-megacycle sidebands is applied to grid No. 1. The phase of the 3.58-megacycle color signal constantly changes in accordance with its color content. For example, the following table shows six variations in color (hue) as a function of subcarrier phase:

Subcarrier Phase-degrees (with respect to 3.58-megacycle local signal in phase with burst)	Hue
13	Yellow
77	Red
119	Magenta
193	Blue
257	Cyan
299	Green



The basic operating principle of the color demodulator shown in Fig. 65 is that plate current from the pentode is zero (or quite low) unless both grid No. 1 and grid No. 3 are simultaneously positive. For example, when the signals applied to the two grids are in phase, plate current can be expected to flow for 180 degrees of each ac cycle. Conversely, when the signals are 180 degrees out of phase, plate current is cut off. The output signal from the detector, therefore, is a function of the phase relationship between the transmitted color signal and the locally generated subcarrier.

In a typical color-television receiver, two color demodulators of the type shown in Fig. 65 are required. In one demodulator, the 3.58-megacycle subcarrier signal is applied directly to the pentode grid No. 3 from the local "burst" oscillator. In the other demodulator, the 3.58-megacycle signal from the burst oscillator is shifted 90 degrees in phase before it is applied to the pentode grid No. 3. As shown previously in Fig. 63, the demodulator B produces R-Y signals. These B-Y and R-Y signals are then combined (matrixed) to produce the G-Y signal, as discussed earlier. The complete luminance signal is then amplified to the required level in a conventional video-amplifier circuit.

In some color-television receivers, the demodulators are designed so that the color output signals can be applied directly to the color picture tube. In the diagram shown in Fig. 66, for example, the 6JH8 sheet-beam demodula-

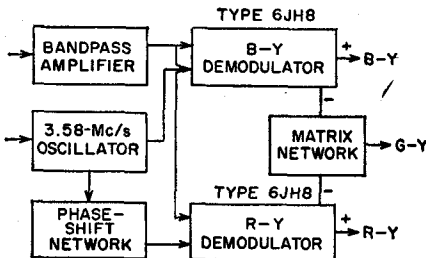

Fig. 66—Block diagram of demodulator circuit used to apply signals directly to color picture tube.

tors produce both positive and negative B-Y and R-Y signals. The positive signals are applied directly to the control grids (grid No. 1) of the blue and red guns of the color picture tube. At the same time, the negative color-difference signals are added (matrixed) in the correct proportions to produce the G-Y signal, which is applied to grid No. 1 of the green gun.

### Automatic Volume or Gain Control

The chief purpose of automatic volume control (avc) or automatic gain control (agc) in a radio or television receiver is to prevent fluctuations in loudspeaker volume or picture brightness when the audio or video signal at the antenna is fading in and out.

An automatic volume control circuit regulates the receiver rf and if gain so that this gain is less for a strong signal than for a weak signal. In this way, when the signal strength at the antenna changes, the avc circuit reduces the resultant change in the voltage output of the last if stage and consequently reduces the change in the speaker output volume.

The avc circuit reduces the rf and if gain for a strong signal usually by increasing the negative bias of the rf, if, and frequency-mixer stage when the signal increases. A simple avc circuit is shown in Fig. 67. On each positive half-cycle of the signal voltage, when the diode plate is positive with respect to the cathode, the diode passes current.

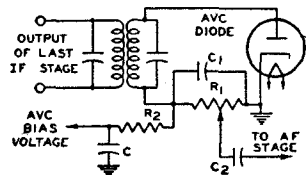

Fig. 67—Automatic-volume-control (avc) circuit.

Because of the flow of diode current through R<sub>1</sub>, there is a voltage drop across R<sub>1</sub> which makes the left end of R<sub>1</sub> negative with respect to ground. This voltage drop across R<sub>1</sub> is applied,

through the filter  $R_2$  and  $C$ , as negative bias on the grids of the preceding stages. When the signal strength at the antenna increases, therefore, the signal applied to the avc diode increases, the voltage drop across  $R_1$  increases, the negative bias voltage applied to the rf and if stages increases, and the gain of the rf and if stages is decreased. Thus the increase in signal strength at the antenna does not produce as much increase in the output of the last if stage as it would produce without avc.

When the signal strength at the antenna decreases from a previous steady value, the avc circuit acts, of course, in the reverse direction, applying less negative bias, permitting the rf and if gain to increase, and thus reducing the decrease in the signal output of the last if stage. In this way, when the signal strength at the antenna changes, the avc circuit acts to reduce change in the output of the last if stage, and thus acts to reduce change in loudspeaker volume.

The filter,  $C$  and  $R_2$ , prevents the avc voltage from varying at audio frequency. The filter is necessary because the voltage drop across  $R_1$  varies with the modulation of the carrier being received. If avc voltage were taken directly from  $R_1$  without filtering, the audio variations in avc voltage would vary the receiver gain so as to smooth out the modulation of the carrier. To avoid this effect, the avc voltage is taken from the capacitor  $C$ . Because of the resistance  $R_2$  in series with  $C$ , the capacitor  $C$  can charge and discharge at only a comparatively slow rate. The avc voltage therefore cannot vary at frequencies as high as the audio range but can vary at frequencies high enough to compensate for most fading. Thus the filter permits the avc circuit to smooth out variations in signal due to fading, but prevents the circuit from smoothing out audio modulation.

It will be seen that an avc circuit and a diode-detector circuit are much alike. It is therefore convenient in a receiver to combine the detector and the avc diode in a single stage. Examples of how these functions are combined in

receivers are shown in **Circuits** section.

In the circuit shown in Fig. 67, a certain amount of avc negative bias is applied to the preceding stages on a weak signal. Because it may be desirable to maintain the receiver rf and if gain at the maximum possible value for a weak signal, avc circuits are designed in some cases to apply no avc bias until the signal strength exceeds a certain value. These avc circuits are known as **delayed avc** or **davc** circuits.

A davc circuit is shown in Fig. 68. In this circuit, the diode section  $D_1$  of the 6H6 acts as detector and avc diode.

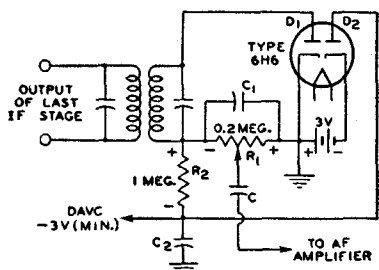

Fig. 68—Delayed avc (davc) circuit.

$R_1$  is the diode load resistor and  $R_2$  and  $C_2$  are the avc filter. Because the cathode of diode  $D_2$  is returned through a fixed supply of  $-3$  volts to the cathode of  $D_1$ , a dc current flows through  $R_1$  and  $R_2$  in series with  $D_2$ . The voltage drop caused by this current places the avc lead at approximately  $-3$  volts (less the negligible drop through  $D_2$ ). When the average amplitude of the rectified signal developed across  $R_1$  does not exceed 3 volts, the avc lead remains at  $-3$  volts. Hence, for signals not strong enough to develop 3 volts across  $R_1$ , the bias applied to the controlled tubes stays constant at a value giving high sensitivity.

However, when the average amplitude of rectified signal voltage across  $R_1$  exceeds 3 volts, the plate of diode  $D_2$  becomes more negative than the cathode of  $D_2$  and current flow in diode  $D_2$  ceases. The potential of the avc lead is then controlled by the voltage developed across  $R_1$ . Therefore, with further increase in signal strength, the avc circuit applies an increasing avc

bias voltage to the controlled stages. In this way, the circuit regulates the receiver gain for strong signals, but permits the gain to stay constant at a maximum value for weak signals.

It can be seen in Fig. 68 that a portion of the  $-3$  volts delay voltage is applied to the plate of the detector diode  $D_1$ , this portion being approximately equal to  $R_1/(R_1 + R_2)$  times  $-3$  volts. Hence, with the circuit constants as shown, the detector plate is made negative with respect to its cathode by approximately one-half volt. However, this voltage does not interfere with detection because it is not large enough to prevent current flow in the tube.

**Automatic gain control (agc)** compensates for fluctuations in rf picture carrier amplitude. The peak carrier level rather than the average carrier level is controlled by the agc voltage because the peaks of the sync pulses are fixed when inserted on a fixed carrier level. The peak carrier level may be determined by measurement of the peaks of the sync pulses at the output of the video detector.

A conventional agc circuit, such as that shown in Fig. 69, consists of a diode

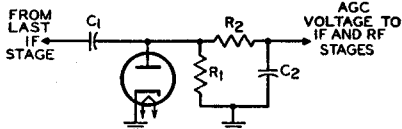

Fig. 69—Automatic gain control (agc) circuit.

detector circuit and an RC filter. The time constant of the detector circuit is made large enough to prevent the picture content from influencing the magnitude of the agc voltage. The output voltage (agc voltage) is equal to the peak value of the incoming signal.

The diode detector receives the incoming signal from the last if stage of the television receiver through the capacitor  $C_1$ . The resistor  $R_1$  provides the load for the diode. The diode conducts only when its plate is driven positive with respect to its cathode. Electrons then flow from the cathode to the plate and thence into capacitor  $C_1$ , where the negative charge is stored. Because of the

low impedance offered by the diode during conduction,  $C_1$  charges up to the value of the peak applied voltage.

During the negative excursion of the signal, the diode does not conduct, and  $C_1$  discharges through resistor  $R_1$ . Because of the large time constant of  $R_1C_1$ , however, only a small percentage of the voltage across  $C_1$  is lost during the interval between horizontal sync pulses. During succeeding positive cycles, the incoming signal must overcome the negative charge stored in  $C_1$  before the diode conducts, and plate current flows only at the peak of each positive cycle. The voltage across  $C_1$ , therefore, is determined by the level of the peaks of the positive cycles, or the sync pulses.

The negative voltage developed across resistor  $R_1$  by the sync pulses is filtered by resistor  $R_2$  and capacitor  $C_2$  to remove the 15,750-cycle ripple of the horizontal sync pulse. The dc output is then fed to the if and rf amplifiers as an agc voltage.

This agc system may be expanded to include amplification of the agc signal before detection of the peak level, or amplification of the dc output, or both. A direct-coupled amplifier must be used for amplification of the dc signal. The addition of amplification makes the system more sensitive to changes in carrier level.

A "keyed" agc system such as that shown in Fig. 70 is used to eliminate flutter and to improve noise immunity in weak signal areas. This system provides more rapid action than the conventional agc circuits because the filter circuit can employ lower capacitance and resistance values.

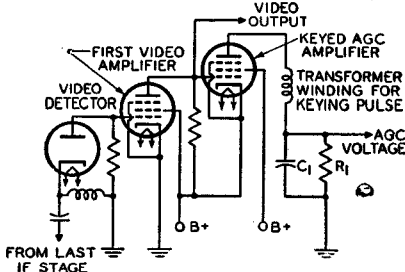

Fig. 70—"Keyed" agc circuit.

In the keyed agc system, the negative output of the video detector is fed directly to the grid No. 1 of the first video amplifier. The positive output of the video amplifier is, in turn, fed directly to the grid No. 1 of the keyed agc amplifier. The video stage increases the gain of the agc system and, in addition, provides noise clipping. The plate voltage for the agc amplifier is a positive pulse obtained from a small winding on the horizontal output transformer which is in phase with the horizontal sync pulse obtained from the video amplifier. The polarity of this pulse is such that the plate of the agc amplifier tube is positive during the retrace time. The tube is biased so that current flows only when the grid No. 1 and the plate are driven positive simultaneously. The amount of current flow depends on the grid-No. 1 potential during the pulse. These pulses are smoothed out in the RC network in the plate circuit ( $R_1C_1$ ). Because the dc voltage developed across  $R_1$  is negative, it is suitable for application to the grids of the rf and if tubes as an agc voltage.

### Tuning Indication With Electron-Ray Tubes

Electron-ray tubes are designed to indicate visually by means of a fluorescent target the effects of a change in controlling voltage. One application of them is as tuning indicators in radio receivers. Types such as the 6U5, 6E5, and the 6AB5/6N5 contain two main parts: (1) a triode which operates as a dc amplifier and (2) an electron-ray indicator which is located in the bulb as shown in Fig. 71. The target is operated at a positive voltage and, therefore, attracts electrons from the cathode. When the electrons strike the target they produce a glow on the fluorescent coating

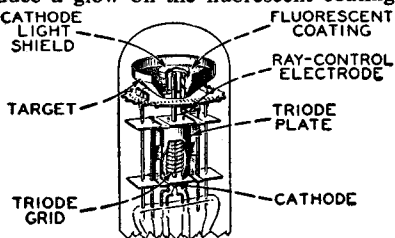

Fig. 71—Structure of electron-ray tube.

of the target. Under these conditions, the target appears as a ring of light.

A ray-control electrode is mounted between the cathode and target. When the potential of this electrode is less positive than the target, electrons flowing to the target are repelled by the electrostatic field of the electrode, and do not reach that portion of the target behind the electrode. Because the target does not glow where it is shielded from electrons, the control electrode casts a shadow on the glowing target. The extent of this shadow varies from approximately 100 degrees of the target when the control electrode is much more negative than the target to 0 degrees when the control electrode is at approximately the same potential as the target.

In the application of the electron-ray tube, the potential of the control electrode is determined by the voltage on the grid of the triode section, as can be seen in Fig. 72. The flow of the triode plate current through resistor  $R$  produces a voltage drop which determines

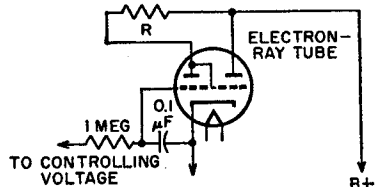

Fig. 72—Indicating circuit using an electron-ray tube.

the potential of the control electrode. When the voltage of the triode grid changes in the positive direction, plate current increases, the potential of the control electrode goes down because of the increased drop across  $R$ , and the shadow angle widens. When the potential of the triode grid changes in the negative direction, the shadow angle narrows.

Another type of indicator tube is the 6AF6G. This tube contains only an indicator unit but employs two ray-control electrodes mounted on opposite sides of the cathode and connected to individual base pins. It employs an external dc amplifier. (See Fig. 73.) Thus, two symmetrically opposite shadow angles may be obtained by connecting the two ray-control electrodes together;

or, two unlike patterns may be obtained by individual connection of each ray-control electrode to its respective amplifier.

In radio receivers, avc voltage is applied to the grid of the dc amplifier. Because avc voltage is at maximum when the set is tuned to give maximum response to a station, the shadow angle is at minimum when the receiver is tuned to resonance with the desired station.

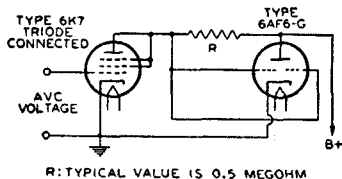

Fig. 73—Indicating circuit using 6AF6G electron-ray tube and external dc amplifier.

The choice between electron-ray tubes depends on the avc characteristic of the receiver. The 6E5 contains a sharp-cutoff triode which closes the shadow angle on a comparatively low value of avc voltage. The 6AB5/6N5 and 6U5 each have a remote-cutoff triode which closes the shadow on a larger value of avc voltage than the 6E5. The 6AF6G may be used in conjunction with dc amplifier tubes having either remote- or sharp-cutoff characteristics.

### Oscillation

As an oscillator, an electron tube can be employed to generate a continuously alternating voltage. In present-day radio broadcast receivers, this application is limited practically to superheterodyne receivers for supplying the heterodyning frequency. Several circuits (represented in Figs. 74 and 75) may be utilized, but they all depend on feeding more energy from the plate circuit to the grid circuit than is required to equal the power loss in the grid circuit. Feedback may be produced by electrostatic or electromagnetic coupling between the grid and plate circuits. When sufficient energy is fed back to more than compensate for the loss in the grid circuit, the tube will oscillate. The action consists of regular surges of power between the plate and the

grid circuit at a frequency dependent on the circuit constants of inductance and capacitance. By proper choice of these values, the frequency may be adjusted over a very wide range.

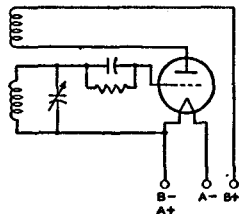

Fig. 74—Tuned-grid triode oscillator circuit using filament-type tube.

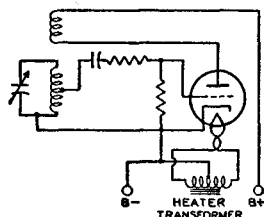

Fig. 75—Tuned-grid triode oscillator circuit using heater-cathode-type tube.

### Multivibrators

Relaxation oscillators, which are widely used in present-day electronic equipment, are used to produce non-sinusoidal waveshapes such as rectangular and sawtooth pulses. Probably the most common relaxation oscillator is the multivibrator, which may be considered as a two-stage resistance-coupled amplifier in which the output of each tube is coupled into the input of the other tube.

Fig. 76 is a basic multivibrator circuit of the free-running type. In this circuit, oscillations are maintained by the alternate shifting of conduction from one tube to the other. The cycle usually starts with one tube,  $V_1$ , at zero bias, and the other,  $V_2$ , at cutoff or beyond. At this point, the capacitor  $C_1$  is charged sufficiently to cut off  $V_2$ .  $C_1$  then begins to discharge through the resistor  $R_1$ , and the voltage on the grid of  $V_2$  rises until  $V_2$  begins to conduct. The voltage on the plate of  $V_2$  then decreases, causing  $V_1$  to conduct less and less. At the same time,

the plate voltage of  $V_1$  begins to rise, causing  $V_2$  to conduct still more heavily. Because of the amplification, this cumulative effect builds up extremely fast, and conduction switches from  $V_1$  to  $V_2$  within a few microseconds, depending on the circuit components.

In this circuit, therefore, conduction switches from  $V_1$  to  $V_2$  over the interval during which  $C_1$  discharges from the voltage across  $R_4$  to the cutoff voltage for  $V_2$ . The actual transfer of conduction does not occur until cutoff is reached. Conduction switches back to  $V_1$  through a similar process to complete the cycle. The plate waveform is essentially rectangular in shape, and may be adjusted as to symmetry, frequency, and amplitude by proper choice of circuit constants, tubes, and voltages.

Although this type of multivibrator is free-running, it may be triggered by

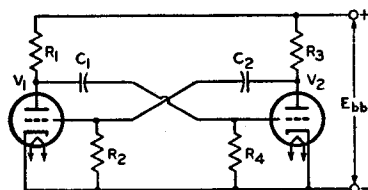

Fig. 76—Basic multivibrator circuit of the free-running type.

pulses of a given amplitude and frequency to provide a frequency-stabilized output. Multivibrator circuits may also be designed so that they are not free-running, but must be triggered externally to shift conduction from one tube to the other. Depending on the type of circuit, conduction may shift back to the first tube after a given time interval, or the second tube may continue conducting until another trigger signal is applied.

### Synchroguide Circuits

The "synchroguide" is a controlled type of oscillator used in television receivers to generate and control the synchronized sawtooth voltage necessary for adequate line- or horizontal-frequency scanning. A simplified synchroguide circuit is shown in Fig. 77. This circuit provides stable, noise-free control

of a blocking oscillator which generates a horizontal-frequency signal. It permits comparison of the received sync pulses and the generated sawtooth voltages so

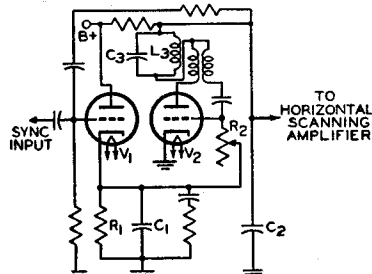

Fig. 77—Simplified synchroguide circuit, that properly locked-in horizontal scanning results.

The triode  $V_2$  in Fig. 77 is a conventional blocking oscillator which enables a sawtooth voltage to be developed across the capacitor  $C_2$ . A portion of this sawtooth is fed back to the grid of the control tube,  $V_1$ . The positive sync pulses are also applied to the grid of  $V_1$ . The waveforms shown in Fig. 78 illustrate the sawtooth and sync pulses (A and B) and their proper "in-sync" combination (C). The sync pulse occurs partly during the portion of the sawtooth voltage in which the triode  $V_1$  draws current. Any shift in sync pulse as it is superimposed on the sawtooth, therefore, will affect the amount of conduction of the control tube. A change in control-tube conduction ultimately affects the bias on the oscillator-tube grid by changing the voltage to which the capacitor  $C_1$  in the cathode circuit may charge. An increase in the positive bias increases the frequency of oscillation.

For example, waveform D in Fig. 78 illustrates a condition in which the sawtooth voltage is advanced in phase

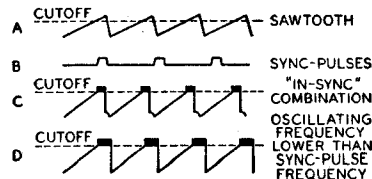

Fig. 78—Sawtooth and sync pulses in synchroguide circuit.

with respect to the sync pulses. The widening of the pulse which occurs at the corner of the sawtooth waveform allows the control tube to conduct more current and, consequently, allows the capacitor  $C_1$  to charge to a higher voltage. This increased reference voltage also appears in the grid circuit of  $V_2$  and makes the grid more positive. The increased grid voltage then speeds up the frequency of oscillations until proper synchronization results.

The blocking oscillator can be made more immune to changes in frequency and noise if  $V_2$  is brought out of cutoff very sharply. This effect is obtained by sine-wave stabilization. The tuned circuit  $L_3C_3$  in the plate circuit of Fig. 77 superimposes a shock-excited sine wave on the plate and grid waveforms, as shown in Fig. 79.

### Deflection Circuits

#### Vertical Output Circuits

A modified multivibrator in which the vertical output tube is part of the oscillator circuit is used in the vertical deflection stage of many television receivers. This stage supplies the deflection energy required for vertical deflection of the picture-tube beam. A simplified combined vertical-oscillator-output stage is shown in Fig. 80. Wave-shapes at critical points of the circuit are included to illustrate the development of the desired current through the vertical output transformer and deflecting yoke.

The current waveform through the deflecting yoke and output transformer

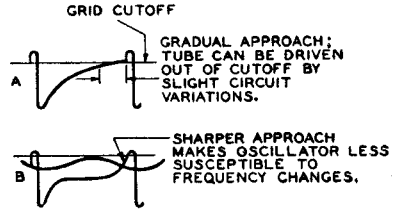

Fig. 79—Waveforms showing effect of tuned circuit  $L_3C_3$  in Fig. 77.

should be a sawtooth to provide the desired deflection. The grid and plate voltage waveforms of the output tube could also be sawtooth except for the effect of the inductive components in the yoke and transformer. The effect of these inductive components must be taken into consideration, however, particularly during retrace. The fast rate of current change during retrace time (which is approximately 1/15 as long as trace time) causes a high-voltage pulse at the plate which could give a trapezoidal waveshape to the plate voltage and cause increased plate current, excess damping, and lengthened retrace time. However, the grid voltage is made sufficiently negative during retrace to keep the tube close to cutoff, as described below.

The frequency, and the relative deviation of the positive and negative portions of each cycle, are dependent on the values of resistors  $R_1$  and  $R_3$  and the RC combination  $R_3C_2$ , as explained previously in the section on multivibrators. The desired trapezoidal waveshape at the grid of  $V_2$  is created by capacitor  $C_1$  and resistor  $R_2$ . If  $R_2$  were equal to

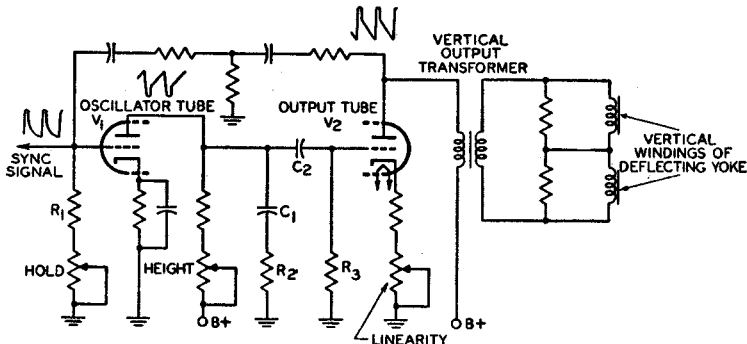

Fig. 80—Simplified combined vertical-oscillator-and-output stage.

zero,  $C_1$  would cause the grid-voltage waveshape to take the form shown in Fig. 81(a). When  $R_2$  is sufficiently large,  $C_1$  does not discharge completely when  $V_1$  conducts. When  $V_1$  is cut off, therefore, the voltage on the grid of  $V_2$  immediately rises to the voltage across  $C_1$ . The resulting waveshape is shown in Fig. 81(b). The negative-going pulse of the grid-voltage waveshape prevents the high plate pulse from causing excess conduction, and thereby prevents overdamping.



Fig. 81—Waveforms showing effect of  $R_2$  in Fig. 80.

This vertical deflection stage utilizes twin-triode tubes such as the 6DR7 and 6EM7. The 6EM7 is particularly suitable for this application because it incorporates dissimilar units to provide for the different operating requirements of the oscillator and output sections.

### Horizontal Output Circuits

Fig. 82 shows a typical horizontal-output-and-deflection circuit used in television receivers. In addition to supplying the deflection energy required for horizontal deflection of the picture-tube beam, this circuit provides the high dc voltage required for the ultor (anode) of the picture tube and the "boosted" B voltage for other portions of the receiver. The horizontal-output tube is usually a beam power tube such as the 6DQ63, 6CD6-GA, or 6GW6.

In this circuit, a sawtooth voltage from the horizontal-oscillator tube is applied to the grid No. 1 of the horizontal-output tube. When this voltage rises above the cutoff point of the output tube, the tube conducts a sawtooth of plate current which is fed through the auto-transformer to the horizontal-deflecting yoke. At the end of the horizontal-scanning cycle, which lasts for 63.4 microseconds, the sawtooth voltage on the grid suddenly cuts off the output tube. This sudden change sets up an

oscillation of about 50 to 70 kilocycles in the output circuit, which may be considered as inductor shunted by the stray capacitance of the circuit. During the first half of this oscillation, a positive voltage appears across the transformer. In the second half of the cycle, the voltage swings below the plate supply voltage, and the damper diode conducts, damping out the oscillation. At the same time, the current through the deflecting yoke reverses and reaches its negative peak. As the damper-diode current decays exponentially to zero, the output tube begins to conduct again. The yoke current, therefore, is composed of current resulting from damper-diode conduction followed by output-tube conduction.

When the output tube is suddenly cut off, the high-voltage pulse produced by shock excitation of the load circuit is increased by means of an extra winding on the transformer. This high-voltage pulse charges a high-voltage capacitor through the high-voltage rectifier. The output of this circuit is the dc high-voltage supply for the picture tube. The high-voltage rectifier also obtains its filament power through a separate wind-

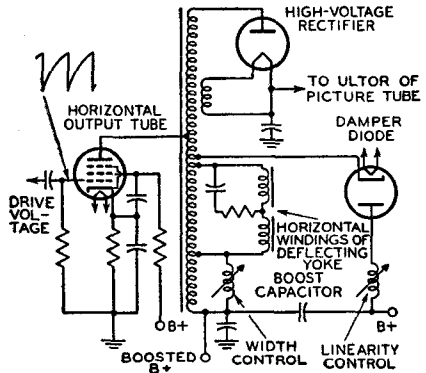

Fig. 82—Typical horizontal-deflection and high-voltage circuit.

ing on the horizontal-output transformer.

Current flowing through the damper diode charges the "boost" capacitor through the damper portion of the transformer winding. The polarity of the charge on the capacitor is such that the



voltage at the low end of the winding is increased above the plate supply voltage, or B+. This higher voltage or "boost" is used for the output-tube plate supply, and may also supply the deflection oscillators and the vertical-output circuit provided the current drain is not excessive.

### High-Voltage Regulator Circuit

In color-television receivers, it is very important to regulate the high-voltage supply to the picture tube. A suitable circuit using the 6BK4 for regulation of the output of a high-voltage, high-impedance supply is shown in Fig. 83. In this circuit, the cathode is held at

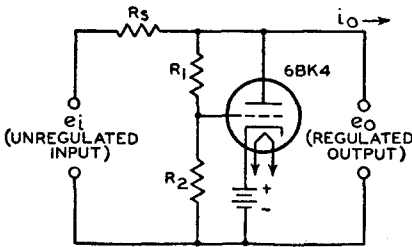

Fig. 83—High-voltage regulator circuit for color television.

a fixed positive potential with respect to ground. Because the grid potential is kept slightly less positive by the voltage drop across resistor  $R_2$ , the tube operates in the negative grid region and no grid current is drawn.

When the output voltage,  $e_o$ , rises as a result of a decrease in load current, a small fraction of the additional voltage is applied to the grid of the tube by the voltage-divider circuit consisting of  $R_1$  and  $R_2$ . This increased grid voltage causes the tube to draw an increased current from the unregulated supply. The increased current, in turn, causes a voltage drop across the high internal impedance of the unregulated supply,  $R_s$ , which tends to counteract the original rise of the voltage. If desired, the grid may be connected to a variable point on the voltage divider to allow some adjustment of the output-voltage level.

The grid voltage for the 6BK4 can also be obtained from a tap on the B-

boost voltage supply. The use of this lower voltage (about 375 volts) eliminates the need for costly and troublesome high-voltage resistors. In this arrangement, variations in high voltage also vary the tapped-down B-boost voltage at the regulator grid, and the resulting variations in conduction of the regulator increase or decrease the loading of the high-voltage supply so that the total load remains nearly constant.

### Frequency Conversion

Frequency conversion is used in superheterodyne receivers to change the frequency of the rf signal to an intermediate frequency. To perform this change in frequency, a frequency-converting device consisting of an oscillator and a frequency mixer is employed. In such a device, shown diagrammatically in Fig. 84, two voltages of different frequency, the rf signal voltage and the voltage generated by the oscillator, are applied to the input of the frequency mixer. These voltages beat, or heterodyne, within the mixer tube to produce a plate current having, in addition to the frequencies of the input voltages, numerous sum and difference frequencies.

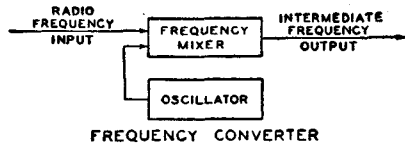

Fig. 84—Block diagram of simple frequency-converter circuit.

The output circuit of the mixer stage is provided with a tuned circuit which is adjusted to select only one beat frequency, *i.e.*, the frequency equal to the difference between the signal frequency and the oscillator frequency. The selected output frequency is known as the intermediate frequency, or *if*. The output frequency of the mixer tube is kept constant for all values of signal frequency by tuning the oscillator to the proper frequency.

Important advantages gained in a receiver by the conversion of signal fre-

quency to a fixed intermediate frequency are high selectivity with few tuning stages and a high, as well as stable, overall gain for the receiver.

Several methods of frequency conversion for superheterodyne receivers are of interest. These methods are alike in that they employ a frequency-mixer tube in which plate current is varied at a combination frequency of the signal frequency and the oscillator frequency. These variations in plate current produce across the tuned plate load a voltage of the desired intermediate frequency. The methods differ in the types of tubes employed and in the means of supply input voltages to the mixer tube.

A method widely used before the availability of tubes especially designed for frequency-conversion service, and currently used in many FM, television, and standard broadcast receivers, employs as mixer tube either a triode, a tetrode, or a pentode, in which oscillator voltage and signal voltage are applied to the same grid. In this method, coupling between the oscillator and mixer circuits is obtained by means of inductance or capacitance.

A second method employs a tube having an oscillator and frequency mixer combined in the same envelope. In one form of such a tube, coupling between the two units is obtained by means of the electron stream within the tube. Because five grids are used, the tube is called a pentagrid converter.

Grids No. 1 and No. 2 and the cathode are connected to an external circuit to act as a triode oscillator. Grid No. 1 is the grid of the oscillator and Grid No. 2 is the anode. These and the cathode can be considered as a composite cathode which supplies to the rest of the tube an electron stream that varies at the oscillator frequency.

This varying electron stream is further controlled by the rf signal voltage on grid No. 4. Thus, the variations in plate current are due to the combination of the oscillator and the signal frequencies. The purpose of grids No. 3 and No. 5, which are connected together within the tube, is to accelerate the electron stream and to shield grid No. 4

electrostatically from the other electrodes.

Pentagrid-converter tubes of this design are good frequency-converting devices at medium frequencies. However, their performance is better at the lower frequencies because the output of the oscillator drops off as the frequency is raised and because certain undesirable effects produced by interaction between oscillator and signal sections of the tube increase with frequency.

To minimize these effects, several of the pentagrid-converter tubes are designed so that no electrode functions alone as the oscillator anode. In these tubes, grid No. 1 functions as the oscillator grid, and grid No. 2 is connected within the tube to the screen grid (grid No. 4). The combined two grids, Nos. 2 and 4, shield the signal grid (grid No. 3) and act as the composite anode of the oscillator triode. Grid No. 5 acts as the suppressor grid.

Converter tubes of this type are designed so that the space charge around the cathode is unaffected by electrons from the signal grid. Furthermore, the electrostatic field of the signal grid also has little effect on the space charge. The result is that rf voltage on the signal grid produces little effect on the cathode current. There is, therefore, little detuning of the oscillator by AVC bias because changes in AVC bias produce little change in oscillator transconductance or in the input capacitance of grid No. 1.

Examples of the pentagrid converters discussed in the preceding paragraph are the single-ended types 1R5 and 6BE6. A schematic diagram illustrating the use of the 6BE6 with self-excitation is given in Fig. 85 the 6BE6 may also be used with separate excitation. A complete circuit is shown in the **Circuits** section.

Another method of frequency conversion utilizes a separate oscillator having its grid connected to the No. 1 grid of a mixer hexode. The cathode, triode grid, and triode plate form the oscillator unit of the tube. The cathode, hexode mixer grid (grid No. 1), hexode screen

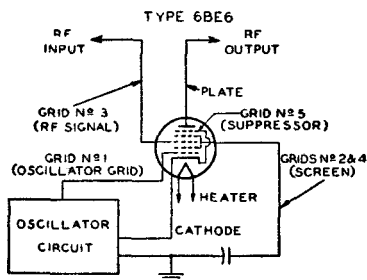

Fig. 85—Frequency-converter circuit using the 6BE6 pentagrid converter with self-excitation.

grids (grids Nos. 2 and 4), hexode signal grid (grid No. 3), and hexode plate constitute the mixer unit. The internal shields are connected to the shell of the tube and act as a suppressor grid for the hexode unit.

The action of this tube in converting a radio-frequency signal to an intermediate frequency depends on (1) the generation of a local frequency by the triode unit, (2) the transferring of this frequency to the hexode grid No. 1, and (3) the mixing in the hexode unit of this frequency with that of the rf signal applied to the hexode grid No. 3. The tube is not critical to changes in oscillator-plate voltage or signal-grid bias and, therefore, finds important use in all-wave receivers to minimize frequency-shift effects at the higher frequencies.

A further method of frequency conversion employs a tube called a pentagrid mixer. This type has two independent control grids and is used with a separate oscillator tube. RF signal voltage is applied to one of the control grids and oscillator voltage is applied to the other. It follows, therefore, that the variations in plate current are due to the combination of the oscillator and signal frequencies.

The tube contains a heater-cathode, five grids, and a plate. Grids Nos. 1 and 3 are control grids. The rf signal voltage is applied to grid No. 1. This grid has a remote-cutoff characteristic and is suited for control by AVC bias voltage. The oscillator voltage is applied to grid No. 3. This grid has a sharp-cutoff characteristic and produces a comparatively

large effect on plate current for a small amount of oscillator voltage. Grids Nos. 2 and 4 are connected together within the tube. They accelerate the electron stream and shield grid No. 3 electrostatically from the other electrodes. Grid No. 5, connected within the tube to the cathode, functions similarly to the suppressor grid in a pentode.

In the converter or mixer stage of a television receiver, stable oscillator operation is most readily obtained when separate tubes or tube sections are used for the oscillator and mixer functions. A typical television mixer-oscillator circuit is shown in Fig. 86. In such circuits, the oscillator voltage is applied to the mixer grid by inductive coupling, capacitive coupling, or a combination of the two. Tubes containing electrically

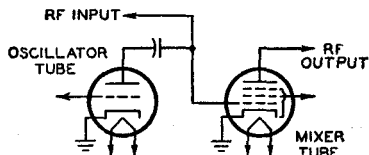

Fig. 86—Typical television mixer-oscillator circuit.

independent oscillator and mixer units in the same envelope, such as the 6U8A and 6X8, are designed especially for this application.

## Automatic Frequency Control

An automatic frequency control (afc) circuit provides a means of correcting automatically the intermediate frequency of a superheterodyne receiver when, for any reason, it drifts from the frequency to which the if stages are tuned. This correction is made by adjusting the frequency of the oscillator. Such a circuit will automatically compensate for slight changes in rf carrier or oscillator frequency as well as for inaccurate manual or push-button tuning.

An afc system requires two sections: a frequency detector and a variable reactance. The detector section may be essentially the same as the FM detector illustrated in Fig. 59 and discussed under **Detection**. In the afc

system, however, the output is a dc control voltage, the magnitude of which is proportional to the amount of frequency shift. This dc control voltage is used to control the grid bias of an electron tube which comprises the variable reactance section (Fig. 87).

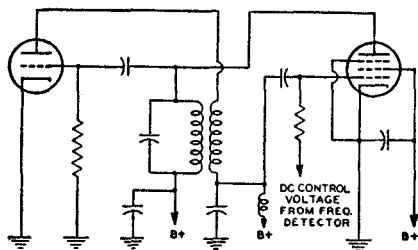

Fig. 87—Automatic-frequency-control (afc) circuit.

The plate current of the reactance tube is shunted across the oscillator tank circuit. Because the plate current and plate voltage of the reactance tube are almost 90 degrees out of phase, the control tube affects the tank circuit in the same manner as a reactance. The grid bias of the tube determines the magnitude of the effective reactance and, consequently, a control of this grid bias can be used to control the oscillator frequency.

Automatic frequency control is also used in television receivers to keep the horizontal oscillator in step with the horizontal-scanning frequency (15,750 cps) at the transmitter. A widely used horizontal afc circuit is shown in Fig. 88. This circuit, which is often referred to as a **balanced-phase-detector** or **phase-discriminator** circuit, is usually employed to control the frequency of a multivibrator-type horizontal-oscillator circuit. The 6AL5 detector supplies a dc control voltage to the grid of the horizontal-oscillator tube which counteracts changes in its operating frequency. The magnitude and polarity of the control voltages are determined by phase relationships in the afc circuit at a given moment.

The horizontal sync pulses obtained from the sync-separator circuit are fed through a single-triode phase-inverter

or phase-splitter circuit to the two diode units of the 6AL5. Because of the action of the phase-inverter circuit, the signals applied to the two diode units are equal in amplitude but 180 degrees out of

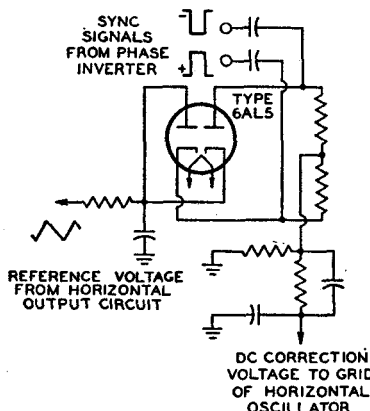

Fig. 88—Balanced phase-detector or phase-discriminator circuit for horizontal afc.

phase. A reference sawtooth voltage obtained from the horizontal output circuit is also applied simultaneously to both units. Any change in the oscillator frequency alters the phase relationship between the reference sawtooth and the incoming horizontal sync pulses, causing one diode unit of the 6AL5 to conduct more heavily than the other, and thus producing a correction signal. The system remains balanced at all times, therefore, because momentary changes in oscillator frequency are instantaneously corrected by the action of the control voltage.

The diode units of the 6AL5 are biased so that conduction takes place only during the tips of the sync pulses. The relative position of the sync pulses on the retrace portion of the sawtooth waveform at any given instant determines which diode unit conducts more heavily, and thereby establishes the magnitude and polarity of the control voltage. The network between the diode units and the grid of the horizontal-oscillator tube is essentially a low-pass filter which prevents the horizontal sync pulses from affecting the horizontal-oscillator performance.

# Electron Tube Installation

**T**HE installation of electron tubes requires care if high-quality performance is to be obtained from the associated circuits. Installation suggestions and precautions which are generally common to all types of tubes are covered in this section. Careful observance of these suggestions will do much to help the experimenter and electronic technician obtain the full performance capabilities of radio tubes and circuits. Additional pertinent information is given under each tube type and in the **Circuits** section.

## Filament and Heater Power Supply

The design of electron tubes allows for some variation in the voltage and current supplied to the filament or heater, but most satisfactory results are obtained from operation at the rated values. When the voltage is low, the temperature of the cathode is below normal, with the result that electron emission is limited. The limited emission may cause unsatisfactory operation and reduced tube life. On the other hand, high cathode voltage may cause rapid evaporation of cathode material and shorten tube life.

To insure proper tube operation, it is important that the filament or heater voltage be checked at the socket terminals by means of a high-resistance voltmeter while the equipment is in operation. In the case of series operation of heaters or filaments, correct adjustment can be checked by means of an ammeter in the heater or filament circuit.

The filament or heater voltage sup-

ply may be a direct-current source (a battery or a dc power line) or an alternating-current power line, depending on the type of service and type of tube. Frequently, a resistor (either variable or fixed) is used with a dc supply to permit compensation for battery voltage variations or to adjust the tube voltage at the socket terminals to the correct value. Ordinarily, a step-down transformer is used with an ac supply to provide the proper filament or heater voltage. Receivers intended for operation on both dc and ac power lines have the heaters connected in series with a suitable resistor and supplied directly from the power line.

**DC filament or heater operation** should be considered on the basis of the source of power. In the case of the battery supply for the 1.4-volt filament tubes, it is unnecessary to use a voltage-dropping resistor in series with the filament and a single dry-cell; the filaments of these tubes are designed to operate satisfactorily over the range of voltage variations that normally occur during the life of a dry-cell. Likewise, no series resistor is required when the 1.25-volt filament subminiatures are operated from a single 1.5-volt flashlight-type dry-cell, when the 2-volt filament-type tubes are operated from a single storage cell, or when the 6.3-volt series are operated from a 6-volt storage battery.

In the case of dry-battery supply for 2-volt filament tubes, a variable resistor in series with the filament and the battery is required to compensate for battery variations. Turning the set on and off by means of the rheostat is advised to prevent over-voltage conditions after an off-period because the

voltage of dry-cells rises during off periods.

In the case of storage-battery supply, air-cell-battery supply, or dc power supply, a non-adjustable resistor of suitable value may be used. It is well to check initial operating conditions, and thus the resistor value, by means of a voltmeter or ammeter.

**AC filament or heater operation** should be considered on the basis of either a parallel or a series arrangement of filaments and/or heaters. In the case of the parallel arrangements, a step-down transformer is employed. Precautions should be taken to see that the line voltage is the same as that for which the primary of the transformer is designed. The line voltage may be determined by measurement with an ac voltmeter (0-150 volts).

If the line voltage measures in excess of that for which the transformer is designed, a resistor should be placed in series with the primary to reduce the line voltage to the rated value of the transformer primary. Unless this is done, the excess input voltage will cause proportionally excessive voltage to be applied to the tubes. Any electron tube may be damaged or made inoperative by excessive operating voltages.

If the line voltage is consistently below that for which the primary of the transformer is designed, it may be necessary to install a booster transformer between the ac outlet and the transformer primary. Before such a transformer is installed, the ac line fluctuations should be very carefully noted. Some radio sets are equipped with a line-voltage switch which permits adjustment of the power transformer primary to the line voltage. When this switch is properly adjusted, the series-resistor or booster-transformer method of controlling line voltage is seldom required.

In the case of the series arrangements of filaments and/or heaters, a voltage-dropping resistance in series with the heaters and the supply line is usually required. This resistance should be of such value that, for normal line voltage, tubes will operate at their rated heater or filament current. The method

for calculating the resistor value is given below.

When the filaments of battery-type tubes are connected in series, the total filament current is the sum of the current due to the filament supply and the plate and grid-No. 2 currents (cathode current) returning to B(-) through the tube filaments. Consequently, in a series filament string it is necessary to add shunt resistors across each filament section to bypass this cathode current in order to maintain the filament voltage at its rated value.

The **filament or heater resistor** required when filaments and/or heaters are operated in parallel can be determined easily by a simple formula derived from Ohm's law.

$$\text{Required resistance (ohms)} = \frac{\text{supply volts} - \text{rated volts of tube type}}{\text{total rated filament current (amperes)}}$$

Thus, if a receiver using two IT4's, one IR5, one IU5, and one 3V4 is to be operated from a storage battery, the series resistor is equal to 2 volts (the voltage from a single storage cell) minus 1.4 volts (voltage rating for these tubes) divided by 0.3 ampere (the sum of  $4 \times 0.05$  ampere +  $1 \times 0.1$  ampere), *i.e.*, approximately 2 ohms. Because this resistor should be variable to allow adjustment for battery depreciation, it is advisable to obtain the next larger commercial size, although any value between 2 and 3 ohms will be quite satisfactory.

Where much power is dissipated in the resistor, the wattage rating should be sufficiently large to prevent overheating. The power dissipation in watts is equal to the voltage drop in the resistor multiplied by the total filament current in amperes. Thus, for the example above,  $0.6 \times 0.3 = 0.18$  watt. In this case, the value is so small that any commercial rheostat with suitable resistance will be adequate.

For the case where the heaters and/or filaments of several tubes are operated in series, the resistor value is calculated by the following formula, also derived from Ohm's law.

$$\text{Required resistance (ohms)} = \frac{\text{supply volts} - \text{total rated volts of tubes}}{\text{rated amperes of tubes}}$$

Thus, if a receiver having one 6BE6, one 6BA6, one 6AT6, one 25L6GT, and one 25Z6GT is to be operated from a 117-volt power line, the series resistor is equal to 117 volts (the supply voltage) minus 68.9 volts (the sum of  $3 \times 6.3$  volts  $+ 2 \times 25$  volts) divided by 0.3 ampere (current rating of these tubes), *i.e.*, approximately 160 ohms. The wattage dissipation in the resistor will be 117 volts minus 68.9 volts times 0.3 ampere, or approximately 14.4 watts. A resistor having a wattage rating in excess of this value should be chosen.

When the series-heater connection is used in ac/dc receivers, it is usually advisable to arrange the heaters in the circuit so that the tubes most sensitive to hum disturbances are at or near the ground potential of the circuit. This arrangement reduces the amount of ac voltage between the heaters and cathodes of these tubes and minimizes the hum output of the receiver. The order of heater connection, by tube function, from chassis to the rectifier-cathode side of the ac line is shown in Fig. 89.

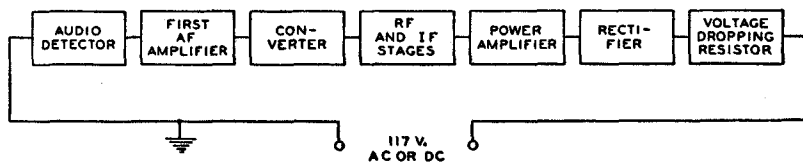

Fig. 89—Order of series heater-string connection, by tube function, to minimize hum.

### Heater-to-Cathode Connection

When heater-type tubes are operated from ac, their cathodes may be returned (through resistors, capacitors, or other components) to the mid-tap on the heater supply winding, to the mid-tap of a small resistor (about 50 ohms) connected across the winding, or to one end of the heater supply winding, depending on circuit requirements. In all circuits, it is important to keep the heater-cathode voltage within the maximum ratings specified for the tube.

Heater-type tubes may produce hum as a result of conduction between heater and cathode or between heater and control grid, or by modulation of

the electron stream by the alternating magnetic field surrounding the heater. When a large resistor is used between heater and cathode (as in series-connected heater strings), or when one side of the heater is grounded, even a minute pulsating leakage current between heater and cathode can develop a small voltage across the cathode-circuit impedance and cause objectionable hum. The use of a large cathode bypass capacitor is recommended to minimize this source of hum.

Much lower hum levels can be achieved when heaters are connected in parallel systems in which the center-tap of the heater supply is grounded or, preferably, connected to a positive bias source of 15 to 80 volts dc to reduce the flow of alternating current. The heater leads of the tubes should be twisted and kept away from high-impedance circuits. The balanced ac supply provides almost complete cancellation of the alternating-current components.

The balanced arrangement described above also minimizes heater-

grid hum. High grid-circuit impedances should be avoided, if possible. High heater voltages should also be avoided because heater-cathode hum rises sharply when the heater voltage is increased above the published value.

Certain tube types are designed especially to minimize hum in high-quality, high-fidelity audio equipment. Examples are the 5879, 7025, and 7199.

### Plate Voltage Supply

The plate voltage for electron tubes is obtained from batteries, rectifiers, direct-current power lines, and small local generators. The maximum plate-voltage value for any tube type should

not be exceeded if most satisfactory performance is to be obtained. Plate voltage should not be applied to a tube unless the corresponding recommended voltage is also supplied to the grid.

It is recommended that the primary circuit of the power transformer be fused to protect the rectifier tube(s), the power transformer, filter capacitor, and chokes in case a rectifier tube fails.

### Grid Voltage Supply

The recommended grid voltages for different operating conditions have been carefully determined to give the most satisfactory performance. Grid voltage may be obtained from a fixed source such as a separate C-battery or a tap on the voltage divider of the high-voltage dc supply, from the voltage drop across a resistor in the cathode circuit, or from the voltage drop across a resistor in the grid circuit. The first method is called "fixed bias"; the second is called "cathode bias" or "self bias"; the third is called "grid-resistor bias" and is sometimes incorrectly referred to in receiving-tube practice as "zero-bias operation."

In any case, the object is to make the grid negative with respect to the cathode by the specified voltage. When a C-battery is used, the negative terminal is connected to the grid return and the positive terminal is connected to the negative filament socket terminal, or to the cathode terminal if the tube is of the heater-cathode type. If the filament is supplied with alternating current, this connection is usually made to the center-tap of a low resistance (20 to 50 ohms) shunted across the filament ter-

minals. This method reduces hum disturbances caused by the ac supply. If bias voltages are obtained from the voltage divider of a high-voltage dc supply, the grid return is connected to a more negative tap than the cathode.

The **cathode-biasing** method utilizes the voltage drop produced by the cathode current flowing through a resistor connected between the cathode and the negative terminal of the B-supply. (See Fig. 90.) The cathode current is, of course, equal to the plate current in the case of a triode, or to the sum of the plate and grid-No. 2 currents in the case of a tetrode, pentode, or beam power tube. Because the voltage drop along the resistance is increasingly negative with respect to the cathode, the required negative grid-bias voltage can be obtained by connecting the grid return to the negative end of the resistance.

The value of the resistance for cathode-biasing a single tube can be determined from the following formula:

$$\text{Resistance (ohms)} = \frac{\text{desired grid-bias voltage} \times 1000}{\text{rated cathode current in milliamperes}}$$

Thus, the resistance required to produce 9 volts bias for a triode which operates at 3 milliamperes plate current is  $9 \times 1000/3 = 3000$  ohms. If the cathode current of more than one tube passes through the resistor, or if the tube or tubes employ more than three electrodes, the total current determines the size of the resistor.

**Bypassing** of the cathode-bias resistor depends on circuit-design requirements. In rf circuits the cathode resistor usually is bypassed. In af circuits the use of an unbypassed resistor will re-

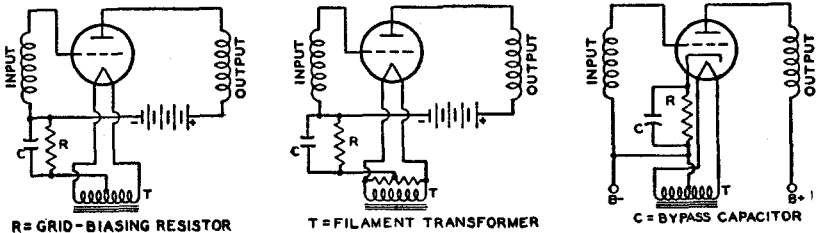

Fig. 90—Typical grid-voltage supply circuits.



duce distortion by introducing degeneration into the circuit. However, the use of an unbypassed resistor decreases gain and power sensitivity. When bypassing is used, it is important that the bypass capacitor be sufficiently large to have negligible reactance at the lowest frequency to be amplified.

In the case of power-output tubes having high transconductance, such as beam power tubes, it may be necessary to shunt the bias resistor with a small mica capacitor (approximately 0.001 $\mu$ F) in order to prevent oscillations. The usual af bypass may or may not be used, depending on whether or not degeneration is desired. In tubes having high values of transconductance, such as the 6BA6, 6CB6, and 6AC7, input capacitance and input conductance change appreciably with plate current. When such a tube having a separate suppressor-grid connection is used as an rf amplifier, these changes may be minimized by leaving a certain portion of the cathode-bias resistor unbypassed. In order to minimize feedback when this method is used, the external grid-No. 1-to-plate (wiring) capacitances should be kept to a minimum, the grid No. 2 should be bypassed to ac ground, and the grid No. 3 should be connected to ac ground.

The use of a cathode resistor to obtain bias voltage is not recommended for amplifiers in which there is appreciable shift of electrode currents with the application of a signal. In such amplifiers, a separate fixed supply is recommended.

The **grid-resistor biasing** method is also a self-bias method because it utilizes the voltage drop across the grid resistor produced by small amounts of grid current flowing in the grid-cathode circuit. This current is due to (1) an electromotive potential difference between the materials comprising the grid and cathode and (2) grid rectification when the grid is driven positive. A large value of resistance is required in order to limit this current to a very small value and to avoid undesirable loading effects on the preceding stage.

Examples of this method of bias are given in circuits 24-1 and 24-3 in

the **Circuits** section. In both of these circuits, the audio amplifier type 1U5 or 12AV6 has a 10-megohm resistor between the grid and the negative filament or cathode to furnish the required bias, which is usually less than 1 volt. This method of biasing is used principally in the early voltage-amplifier stages (usually employing high- $\mu$  triodes) of audio amplifier circuits, where the tube dissipation will not be excessive under zero-signal conditions.

A grid resistor is also used in many oscillator circuits for obtaining the required bias. In these circuits, the grid voltage is relatively constant and its magnitude is usually in the order of 5 volts or more. Consequently, the bias voltage is obtained only through grid rectification. A relatively low value of resistor, 0.1 megohm or less, is used. Oscillator circuits employing this method of bias are given in circuits 24-1 and 24-2 in the **Circuits** section.

**Grid-bias variation** for the rf and if amplifier stages is a convenient and frequently used method for controlling receiver volume. The variable voltage supplied to the grid may be obtained: (1) from a variable cathode resistor as shown in Figs. 91 and 92; (2) from a bleeder circuit by means of a potentiometer as shown in Fig. 93; or (3) from a bleeder circuit in which the bleeder current is varied by a tube

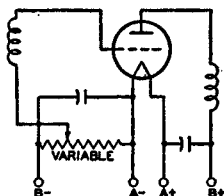

Fig. 91—Amplifier stage using a variable cathode-bias resistor for volume control.

used for automatic volume control. The latter circuit is shown in Fig. 67.

In all cases it is important that the control be arranged so that at no time will the bias be less than the recommended minimum grid-bias voltage for the particular tubes used. This requirement can be met by providing a fixed stop on the potentiometer, by

connecting a fixed resistance in series with the variable resistance, or by connecting a fixed cathode resistance in series with the variable resistance used for regulation. Where receiver gain is

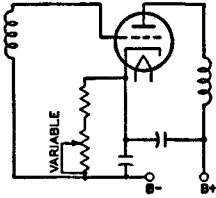

Fig. 92—Amplifier stage similar to Fig. 91 but using heater-cathode-type tube.

controlled by grid-bias variation, it is advisable to have the control voltages extend over a wide range in order to minimize cross-modulation and modulation-distortion. A remote-cutoff type of tube should, therefore, be used in the controlled stages.

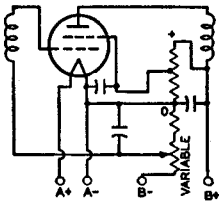

Fig. 93—Amplifier stage using a bleeder circuit and potentiometer for volume control.

In most tubes employing a unipotential cathode, a **positive grid current** begins to flow when the grid is slightly negative and increases rapidly as the grid is made more positive, as shown in Fig. 94. The value of grid voltage at which the grid-current curve intercepts the horizontal axis is determined by several different physical processes, including an electrothermal effect due to the differences in temperature and in material composition of the grid and the cathode, and by the positive grid current. For values of grid potentials which are larger than this intercept, the direction of the grid current is positive (*i.e.*, from the grid to the cathode). At smaller values of grid potential, the direction of the grid current

is negative (*i.e.*, from the cathode to the grid).

Positive grid current consists of electrons emitted from the cathode which are intercepted by the control grid. Negative grid current, which becomes appreciable only when the grid potential is more negative than the value of the intercept, is a result of the emission of electrons from the heated control grid to the cathode, the effect of gas molecules in the tube, and the influence of leakage currents between the grid and cathode and the grid and the plate.

The value of grid potential at the intercept of the grid-current curve on the horizontal axis (often mistakenly called **contact potential**) may be as high as  $1\frac{1}{2}$  volts. If the operating bias of the tube is less than this intercept, it is found that two effects are present. Direct current flows in the grid circuit, and the dynamic input resistance of the tube may be relatively low. It is generally desirable to supply the tube with a value of bias sufficiently high so that the operating point of the tube is not near the value of this intercept. If the value of the operating bias is near the value of the intercept, care should be taken to avoid undesirable effects in the grid circuit due to grid current or low input resistance.

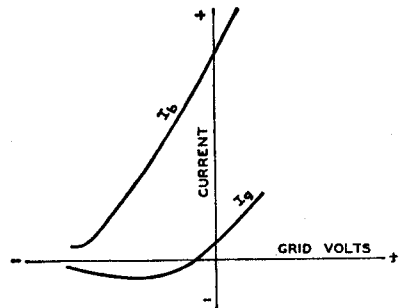

Fig. 94—Curves showing flow of positive grid current in tubes employing unipotential cathodes.

## Screen-Grid Voltage Supply

The positive voltage for the screen grid (grid No. 2) of screen-grid tubes

may be obtained from a tap on a voltage divider, from a potentiometer, or from a series resistor connected to a high-voltage source, depending on the particular tube type and its application. The screen-grid voltage for tetrodes should be obtained from a voltage divider or a potentiometer rather than through a series resistor from a high-voltage source because of the characteristic screen-grid current variations of tetrodes. Fig. 95 shows a tetrode with its screen-grid voltage obtained from a potentiometer.

When pentodes or beam power tubes are operated under conditions where a large shift of plate and screen-grid currents does not take place with the application of the signal, the screen-grid voltage may be obtained through a series resistor from a high-voltage

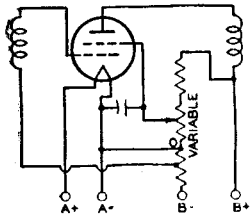

Fig. 95—Tetrode circuit in which screen-grid voltage is obtained from a potentiometer.

source. This method of supply is possible because of the high uniformity of the screen-grid current characteristic in pentodes and beam power tubes. Because the screen-grid voltage rises with increase in bias and resulting decrease in screen-grid current, the cutoff characteristic of a pentode is extended by this method of supply.

This method is sometimes used to increase the range of signals which can be handled by a pentode. When used in resistance-coupled amplifier circuits employing pentodes in combination with the cathode-biasing method, it minimizes the need for circuit adjustments. Fig. 96 shows a pentode with its screen-grid voltage supplied through a series resistor.

When power pentodes and beam power tubes are operated under conditions such that there is a large change

in plate and screen-grid currents with the application of signal, the series-resistor method of obtaining screen-grid voltage should not be used. A change in screen-grid current appears as a

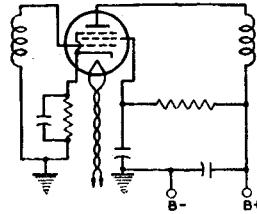

Fig. 96—Pentode circuit in which screen-grid voltage is supplied through a series resistor.

change in the voltage drop across the series resistor in the screen-grid circuit; the result is a change in the power output and an increase in distortion. The screen-grid voltage should be obtained from a point in the plate-voltage-supply filter system having the correct voltage, or from a separate source.

It is important to note that the plate voltage of tetrodes, pentodes, and beam power tubes should be applied before or simultaneously with the screen-grid voltage. Otherwise, with voltage on the screen grid only, the screen-grid current may rise high enough to cause excessive screen-grid dissipation.

**Screen-grid voltage variation** for the rf amplifier stages has sometimes been used for volume control in older-type receivers. Reduced screen-grid voltage decreases the transconductance of the tube and results in reduced gain per stage. The voltage variation is obtained by means of a potentiometer shunted across the screen-grid voltage supply. (See Fig. 95.) When the screen-grid voltage is varied, it must never exceed the rating of the tube. This requirement can be met by providing a fixed stop on the potentiometer.

## Shielding

In high-frequency stages having high gain, the output circuit of each stage must be shielded from the input circuit of that stage. Each high-fre-

quency stage also must be shielded from the other high-frequency stages. Unless shielding is employed, undesired feedback may occur and may produce many harmful effects on receiver performance.

To prevent this feedback, it is a desirable practice to shield separately each unit of the high-frequency stages. For instance, in a superheterodyne receiver, each if and rf coil may be mounted in a separate shield can. Baffle plates may be mounted on the ganged tuning capacitor to shield each section of the capacitor from the other section. The oscillator coil may be especially well shielded by being mounted under the chassis.

The shielding precautions required in a receiver depend on the design of the receiver and the layout of the parts. In all receivers having high-gain high-frequency stages, it is necessary to shield separately each tube in high-frequency stages. When metal tubes, and in particular the single-ended types, are used, complete shielding of each tube is provided by the metal shell which is grounded through its grounding pin as the socket terminal. The grounding connection should be short and sturdy. Many modern tubes of glass construction have internal shields, usually connected to the cathode; where present, these shields are indicated in the socket diagram.

### Dress of Circuit Leads

At high frequencies such as are encountered in FM and television receivers, lead dress, that is, the location and arrangement of the leads used for connections in the receiver, is very important. Because even a short lead provides a large impedance at high frequencies, it is necessary to keep all high-frequency leads as short as possible. This precaution is especially important for ground connections and for all connections to bypass capacitors and high-frequency filter capacitors. The ground connections of plate and screen-grid bypass capacitors of each tube should be kept short and made directly to cathode ground.

Particular care should be taken with the lead dress of the input and output circuits of high-frequency stages so that the possibility of stray coupling is minimized. Unshielded leads connected to shielded components should be dressed close to the chassis. As the frequency increases, the need for careful lead dress becomes increasingly important.

In high-gain audio amplifiers, these same precautions should be taken to minimize the possibility of self-oscillation.

### Filters

Feedback effects also are caused in radio or television receivers by coupling between stages through common voltage-supply circuits. Filters find an important use in minimizing such effects. They should be placed in voltage-supply leads to each tube in order to return the signal current through a low-impedance path direct to the tube cathode rather than by way of the voltage-supply circuit. Fig. 97 illustrates several forms of filter circuits. Capacitor C

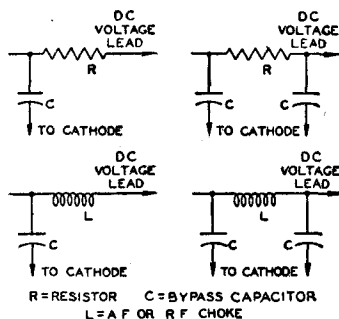

Fig. 97—Typical filter circuits.

forms the low-impedance path, while the choke or resistor assists in diverting the signal through the capacitor by offering a high impedance to the power-supply circuit.

The choice between a resistor and a choke depends chiefly upon the permissible dc voltage drop through the filter. In circuits where the current is small (a few milliamperes), resistors are practical; where the current is large or

regulation important, chokes are more suitable.

The minimum practical size of the capacitors may be estimated in most cases by the following rule: The impedance of the capacitor at the lowest frequency amplified should not be more than one-fifth of the impedance of the filter choke or resistor at that frequency. Better results will be obtained in special cases if the ratio is not more than one-tenth.

Radio-frequency circuits, particularly at high frequencies, require high-quality capacitors. Mica or ceramic capacitors are preferable. Where stage shields are employed, filters should be placed within the shield.

Another important application of filters is to smooth the output of a rectifier tube. (See **Rectification**.) A smoothing filter usually consists of capacitors and iron-core chokes. In any filter-design problem, the load impedance must be considered as an integral part of the filter because the load is an important factor in filter performance. Smoothing effect is obtained from the chokes because they are in series with the load and offer a high impedance to the ripple voltage. Smoothing effect is obtained from the capacitors because they are in parallel with the load and store energy on the voltage peaks; this energy is released on the voltage dips and serves to maintain the voltage at the load substantially constant. Smoothing filters are classified as choke-input or capacitor-input according to whether a choke or capacitor is placed next to the rectifier tube. (See Fig. 98.)

The **Circuits** section gives a number of examples of rectifier circuits with recommended filter constants.

If an input capacitor is used, consideration must be given to the instantaneous peak value of the ac input voltage. This peak value is about 1.4 times the rms value as measured by an ac voltmeter. Filter capacitors, therefore, especially the input capacitor, should have a rating high enough to withstand the instantaneous peak value if breakdown is to be avoided. When the input-choke method is used, the available dc output voltage will be somewhat lower than with the input-capacitor method for a given ac plate voltage. However, improved regulation together with lower peak current will be obtained.

Mercury-vapor and gas-filled rectifier tubes occasionally produce a form of local interference in radio receivers through direct radiation or through the power line. This interference is generally identified in the receiver as a broadly tunable 120-cycle buzz (100 cycles for 50-cycle supply line, etc.). It is usually caused by the formation of a steep wave front when plate current within the tube begins to flow on the positive half of each cycle of the ac supply voltage.

There are several ways of eliminating this type of interference. One is to shield the tube. Another is to insert an rf choke having an inductance of one millihenry or more between each plate and transformer winding and to connect high-voltage, rf bypass capacitors between the outside ends of the transformer winding and the center tap. (See Fig. 99.) The rf chokes should be placed within the shielding of the tube. The rf bypass capacitors should have a voltage rating high enough to withstand the peak voltage of each half of the secondary, which is approximately 1.4 times the rms value.

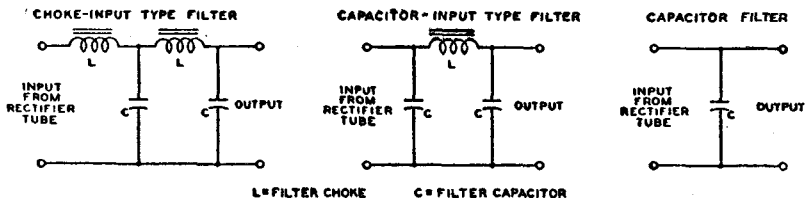

Fig. 98—Typical smoothing filters for rectifier tubes.



isolated as far as possible from signal connections, especially from the input connection. Signal-carrying conductors, even when shielded, should not be cabled together with power-supply conductors. Internal wiring for ac-operated tube heaters, switches, pilot-light sockets, and other devices, should be twisted and placed flat against the chassis. All connections to the ground side of the circuit in each unit should be made to a common bus of heavy wire. This bus should be connected to the chassis only at the point of minimum signal voltage, *i.e.*, at the signal-input terminal of the unit.

All internal wiring that carries signal voltages should be as short as possible, and as far as possible above the chassis, to minimize losses at the higher audio frequencies due to stray shunt capacitance. All connections between units should be made with shielded cable having a capacitance of not more than 30 picofarads per foot, such as Alpha Type 1249 or 1704, Belden Type 8401 or 8410, or equivalent cable.

Because power amplifiers and power-supply units of high-fidelity systems normally dissipate large amounts of heat, they should be constructed and installed in such a manner as to assure adequate ventilation for the tubes and other components. A beam power tube or rectifier tube should be separated from any other tube or component on the same side of the chassis by at least  $1\frac{1}{2}$  tube diameters.

Power amplifiers and power-supply units which are to be installed horizontally (*i.e.*, with the tubes vertical) in cabinets or on shelves should be provided with mounting feet, perforated bottom covers, and a number of small holes around each tube socket to permit relatively cool air to enter from below and provide ventilation for the under side of the chassis and tubes.

If a power amplifier, tone-control amplifier, and one or more preamplifiers are to be constructed on the same chassis, the mechanical layout should be planned so that the circuits operating at the lowest signal levels are farthest from the output stage and

power supply. Amplifier units which normally operate at comparable signal levels but are not used simultaneously (such as preamplifiers for tape pickup heads and magnetic phonograph pickups) may be installed side by side on the same chassis without danger of interaction. Units which operate simultaneously, however (such as the channels of a stereophonic system), should not be installed side by side on the same chassis without careful consideration to placement of components and wiring, and the possible use of shielding to prevent interaction.

When an amplifier, preamplifier, mixer, or other unit requiring heater power is located more than five or six feet from its power-supply unit, the heater-current conductors in the power-supply cable must be large enough to assure that each tube receives its rated heater voltage. In cases where very large heater currents or very long power-supply cables are involved, it may be desirable to install a heater-supply transformer on or near the amplifier unit. If such a transformer is installed on or near a preamplifier for a magnetic-tape pickup head, a magnetic phonograph pickup, or a dynamic microphone, the transformer should be completely shielded and positioned to prevent its field from inducing hum in the pickup device.

## High-Voltage Considerations for Television Picture Tubes

Like other high-voltage devices, television picture tubes require that certain precautions be observed to minimize the possibility of failure caused by humidity, dust, and corona.

**Humidity Considerations.** When humidity is high, a continuous film of moisture may form on the glass bulb immediately surrounding the anode cavity cap of all-glass picture tubes or on the glass part of the envelope of metal picture tubes. This film may permit sparking to take place over the glass surface to the external conductive coating or to the metal shell. Such sparking may introduce noise into the

receiver. To prevent such a possibility, the uncoated bulb surface around the cap and the glass part of the envelope of metal picture tubes should be kept clean and dry.

**Dust Considerations.** The accumulation of dust on the uncoated area of the bulb around the anode cap of all-glass picture tubes or on the glass part of the envelope or insulating supports for metal picture tubes will decrease the insulating qualities of these parts. The dust usually consists of fibrous materials and may contain soluble salts. The fibers absorb and retain moisture; the soluble salts provide electrical leakage paths that increase in conductivity as the humidity increases. The resulting high leakage currents may overload the high-voltage power supply.

It is recommended, therefore, that the uncoated bulb surface of all-glass picture tubes and the coated glass surface and insulating supports for metal picture tubes be kept clean and free from dust or other contamination such as finger-prints. The frosted Filterglass faceplate of the metal picture tubes may be cleaned with a soapless detergent, such as Dreft, then rinsed with clean water, and immediately dried.

**Corona Considerations.** A high-voltage system may be subject to corona, especially when the humidity is high, unless suitable precautions are taken. Corona, which is an electrical discharge appearing on the surface of a conductor when the voltage gradient exceeds the breakdown value of air, causes deterioration of organic insulating materials through formation of ozone, and induces arc-over at points and sharp edges. Sharp points or other irregularities on any part of the high-voltage system may increase the possibility of corona and should be avoided.

In the metal-shell picture tubes,

the metal lip at the maximum diameter has rounded edges to prevent corona. Adequate spacing between the lip and any grounded element in the receiver, or between the small end of the metal shell and any grounded element, should be provided to preclude the possibility of corona. Such spacing should not be less than 1 inch of air. Similarly, an air space of 1 inch, or equivalent, should be provided around the body of the metal shell. As a further precaution to prevent corona, the deflecting-yoke surface on the end adjacent to the shell should present a smooth electrical surface with respect to the small end of the metal shell or the anode terminal of all-glass tubes.

### Picture-Tube Safety Considerations

**Tube Handling.** Breakage of picture tubes, which contain a high vacuum, may result in injury from flying glass. Do not strike or scratch the tube or subject it to more than moderate pressure when installing it in or removing it from electronic equipment.

**High-Voltage Precautions.** In picture-tube circuits, high voltages may appear at normally low-potential points in the circuit because of capacitor breakdown or incorrect circuit connections. Therefore, before any part of the circuit is touched the power-supply switch should be turned off, the power plug disconnected, and both terminals of any capacitors grounded.

**X-Ray Radiation Precautions.** All types of picture tubes may be operated at voltages (if ratings permit) up to 16 kilovolts without producing harmful x-ray radiation or danger of personal injury on prolonged exposure at close range. Above 16 kilovolts, special x-ray shielding precautions may be necessary.



# Interpretation of Tube Data

**T**HE tube data given in the following **Technical Data** section include ratings, typical operation values, characteristics, and characteristic curves.

The values for grid-bias voltages, other electrode voltages, and electrode supply voltages are given with reference to a specified **datum point** as follows: For types having filaments heated with dc, the negative filament terminal is taken as the datum point to which other electrode voltages are referred. For types having filaments heated with ac, the mid-point (*i.e.*, the center tap on the filament-transformer secondary, or the mid-point on a resistor shunting the filament) is taken as the datum point. For types having unipotential cathodes indirectly heated, the cathode is taken as the datum point.

**Ratings** are established on electron tube types to help equipment designers utilize the performance and service capabilities of each tube type to best advantage. Ratings are given for those characteristics which careful study and experience indicate must be kept within certain limits to insure satisfactory performance.

Three rating systems are in use by the electron-tube industry. The oldest is known as the **Absolute Maximum** system, the next as the **Design Center** system, and the latest and newest as the **Design Maximum** system. Definitions of these systems have been formulated by the Joint Electron Device Engineering Council (JEDEC) and standardized by the National Electrical Manufacturers Association (NEMA) and the Electronic Industries Association (EIA) as follows:

**Absolute Maximum** ratings are limiting values which should not be exceeded with any tube of the specified type under any condition of operation. These ratings are used only in rare instances for receiving types, but are generally used for transmitting and industrial types.

**Design Center** ratings are limiting values which should not be exceeded with a tube of the specified type having characteristics equal to the published values under normal operating conditions. These ratings, which include allowances for normal variations in both tube characteristics and operating conditions, were used for most receiving tubes prior to 1957.

**Design Maximum** ratings are limiting values which should not be exceeded with a tube of the specified type having characteristics equal to the published values under any conditions of operation. These ratings include allowances for normal variations in tube characteristics, but do not provide for variations in operating conditions. **Design Maximum** ratings were adopted for receiving tubes in 1957.

**Electrode voltage and current ratings** are in general self-explanatory, but a brief explanation of other ratings will aid in the understanding and interpretation of tube data.

**Heater warm-up time** is defined as the time required for the voltage across the heater to reach 80 per cent of the rated value in the circuit shown in Fig. 101. The heater is placed in series with a resistance having a value 3 times the nominal heater operating resistance

( $R = 3 E_f / I_f$ ), and a voltage having a value 4 times the rated heater voltage ( $V = 4 E_f$ ) is then applied. The warm-up time is determined when  $E = 0.8 E_f$ .

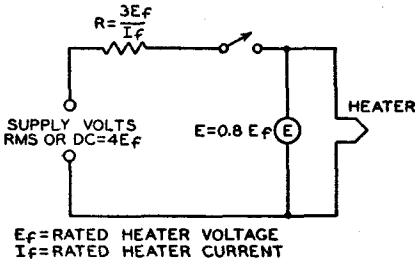

Fig. 101—Test circuit for measuring heater warm-up time.

**Plate dissipation** is the power dissipated in the form of heat by the plate as a result of electron bombardment. It is the difference between the power supplied to the plate of the tube and the power delivered by the tube to the load.

**Grid-No. 2 (Screen-grid) Input** is the power applied to the grid-No. 2

electrode and consists essentially of the power dissipated in the form of heat by grid No. 2 as a result of electron bombardment. With tetrodes and pentodes, the power dissipated in the screen-grid circuit is added to the power in the plate circuit to obtain the total B-supply input power.

When the screen-grid voltage is supplied through a series voltage-dropping resistor, the maximum screen-grid voltage rating may be exceeded, provided the maximum screen-grid dissipation rating is not exceeded at any signal condition, and the maximum screen-grid voltage rating is not exceeded at the maximum-signal condition. Provided these conditions are fulfilled, the screen-grid supply voltage may be as high as, but not above, the maximum plate voltage rating.

For certain voltage amplifier types, as listed in the data section, the maximum permissible screen-grid (grid-No. 2) input varies with the screen-grid voltage, as shown in Fig. 102. (This curve cannot be assumed to apply to

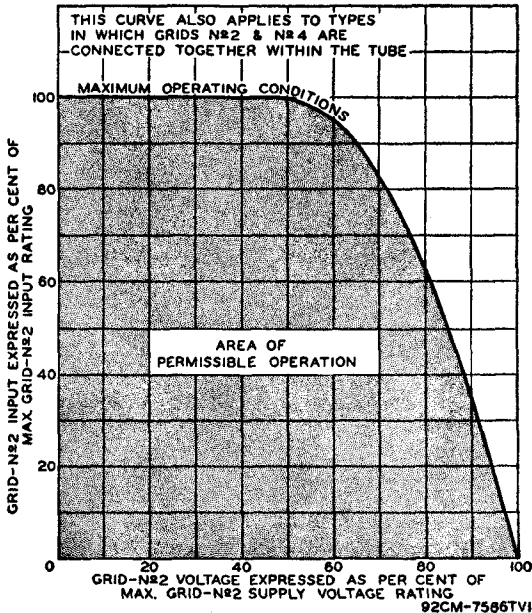

Fig. 102—Grid-No. 2 input rating curve.

types other than those for which it is specified in the data section.) Full rated screen-grid input is permissible at screen-grid voltages up to 50 per cent of the maximum rated screen-grid supply voltage. From the 50-per-cent point to the full rated value of supply voltage, the screen-grid input must be decreased. The decrease in allowable screen-grid input follows a curve of the parabolic form. This rating chart is useful for applications utilizing either a fixed screen-grid voltage or a series screen-grid voltage-dropping resistor. When a fixed voltage is used, it is necessary only to determine that the screen-grid input is within the boundary of the operating area on the chart at the selected value of screen-grid voltage to be used. When a voltage-dropping resistor is used, the minimum value of resistor that will assure tube operation within the boundary of the curve can be determined from the following relation:

$$R_{g2} > \frac{E_{c2} (E_{cc2} - E_{c2})}{P_{c2}}$$

where  $R_{g2}$  is the minimum value for the voltage-dropping resistor in ohms,  $E_{c2}$  is the selected screen-grid voltage in volts,  $E_{cc2}$  is the screen-grid supply voltage in volts, and  $P_{c2}$  is the screen-grid input in watts corresponding to  $E_{c2}$ .

**Peak heater-cathode voltage** is the highest instantaneous value of voltage that a tube can safely stand between its heater and cathode. This rating is applied to tubes having a separate cathode terminal and used in applications where excessive voltage may be introduced between heater and cathode.

**Maximum dc output current** is the highest average plate current which can be handled continuously by a rectifier tube. Its value for any rectifier tube type is based on the permissible plate dissipation of that type. Under operating conditions involving a rapidly repeating duty cycle (steady load), the average plate current may be measured with a dc meter.

The nomograph shown in Fig. 103 can be used to determine tube voltage drop or plate current for any diode unit when values for a single plate-

voltage, plate-current condition are available from the data. It can also be used to compare the relative perveance ( $G = I_b/E_b^{3/2}$ ) of several diodes. **Perveance** can be considered a figure of merit for diodes; high-perveance units have lower voltage drop at a fixed current level.

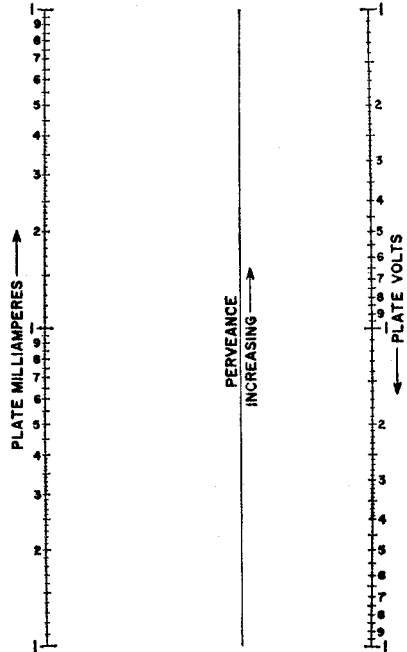

92CM-11244

Fig. 103—Diode perveance nomograph.

Tube voltage drop or plate current for a specific diode unit can be determined as follows: First, convenient values are selected for the plate-voltage and plate-current scales of the nomograph. The published plate-current and plate-voltage values are then located on the scales and connected with a straight edge. The intersection of the connecting line with the perveance scale is then used as a pivot point to determine the value of tube voltage drop corresponding to a desired current value, or the value of plate current corresponding to a desired tube voltage drop. Because the pivot point for a specific diode unit represents its perveance, the pivot

points for several units (plotted to the same scales) can be used to compare their relative permeance.

For example, type 5U4GB has a tube voltage drop (per plate) of 44 volts at a plate current of 225 milliamperes. Convenient scales for this type are from 1 to 100 volts for plate voltage and from 10 to 1000 milliamperes for plate current. The points 44 volts and 225 milliamperes are then connected with a straight line to determine the pivot point. Using this pivot point, it is easy to determine such values as a plate current of 150 milliamperes at a tube voltage drop of 33 volts, or a voltage drop of 25 for a current of 100 milliamperes.

For readings in the order of one volt and/or one milliampere, the nomograph is not accurate because of the effects of contact potential and initial electron velocity.

**Maximum peak plate current** is the highest instantaneous plate current that a tube can safely carry recurrently in the direction of normal current flow. The safe value of this peak current in hot-cathode types of rectifier tubes is a function of the electron emission available and the duration of the pulsating current flow from the rectifier tube in each half-cycle.

The value of peak plate current in a given rectifier circuit is largely determined by filter constants. If a large choke is used at the filter input, the peak plate current is not much greater than the load current; but if a large capacitor is used as the filter input, the peak current may be many times the load current. In order to determine accurately the peak plate current in any rectifier circuit, measure it with a peak-indicating meter or use an oscillograph.

**Maximum peak inverse plate voltage** is the highest instantaneous plate voltage which the tube can withstand recurrently in the direction opposite to that in which it is designed to pass current. For mercury-vapor tubes and gas-filled tubes, it is the safe top value to prevent arc-back in the tube operating within the specified temperature range.

Referring to Fig. 104, when plate A

of a full-wave rectifier tube is positive, current flows from A to C, but not from B to C, because B is negative. At the instant plate A is positive, the filament is positive (at high voltage) with respect to plate B. The voltage between the positive filament and the negative plate

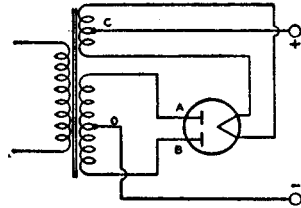

Fig. 104—Schematic diagram of full-wave rectifier tube and circuit connections.

B is in inverse relation to that causing current flow. The peak value of this voltage is limited by the resistance and nature of the path between plate B and filament. The maximum value of this voltage at which there is no danger of breakdown of the tube is known as maximum peak inverse voltage.

The relations between peak inverse voltage, rms value of ac input voltage, and dc output voltage depend largely on the individual characteristics of the rectifier circuit and the power supply. The presence of line surges or any other transient, or wave-form distortion, may raise the actual peak voltage to a value higher than that calculated for sine-wave voltages. Therefore, the **actual** inverse voltage, and not the calculated value, should be such as not to exceed the rated maximum peak inverse voltage for the rectifier tube. A calibrated cathode-ray oscillograph or a peak-indicating electronic voltmeter is useful in determining the actual peak inverse voltage.

In single-phase, full-wave circuits with sine-wave input and with no capacitor across the output, the peak inverse voltage on a rectifier tube is approximately 1.4 times the rms value of the plate voltage applied to the tube. In single-phase, half-wave circuits with sine-wave input and with capacitor input to the filter, the peak inverse volt-

age may be as high as 2.8 times the rms value of the applied plate voltage. In polyphase circuits, mathematical determination of peak inverse voltage requires the use of vectors.

The **Rating Chart** for full-wave rectifiers presents graphically the relationships between maximum ac voltage input and maximum dc output current derived from the fundamental ratings for conditions of capacitor-input and choke-input filters. This graphical presentation provides for considerable latitude in choice of operating conditions.

The **Operation Characteristics** for a full-wave rectifier with capacitor-input filter show by means of boundary line the limiting current and voltage relationships presented in the Rating Chart.

The **Operation Characteristics** for a full-wave rectifier with choke-input filter not only show by means of boundary line the limiting current and voltage relationships presented in the Rating Chart, but also give some information as to the effect on regulation of various sizes of chokes. The solid-line curves show the dc voltage outputs which would be obtained if the filter chokes had infinite inductance. The long-dash lines radiating from the zero position are boundary lines for various sizes of chokes as indicated. The intersection of one of these lines with a solid-line curve indicates the point on the curve at which the choke no longer behaves as though it had infinite inductance. To the left of the choke boundary line, the regulation curves depart from the solid-line curves as shown by the representative short-dash regulation curves.

**Typical Operation Values.** Values for typical operation are given for many types in the **Technical Data** section. These typical operating values are given to show concisely some guiding information for the use of each type. These values should not be confused with ratings, because a tube can be used under any suitable conditions within its maximum ratings, according to the application.

The power output value for any operating condition is an approximate tube output—that is, plate input minus

plate loss. Circuit losses must be subtracted from tube output in order to determine the useful output.

**Characteristics** are covered in the **Electron Tube Characteristics** section and such data should be interpreted in accordance with the definitions given in that section. **Characteristic curves** represent the characteristics of an average tube. Individual tubes, like any manufactured product, may have characteristics that range above or below the values given in the characteristic curves.

Although some curves are extended well beyond the maximum ratings of the tube, this extension has been made only for convenience in calculations. **Do NOT** operate a tube outside of its maximum ratings.

**Interelectrode capacitances** are direct capacitances measured between specified elements or groups of elements in electron tubes. Unless otherwise indicated in the data, all capacitances are measured with filament or heater cold, with no direct voltages present, and with no external shields. All electrodes other than those between which capacitance is being measured are grounded. In twin or multi-unit types, inactive units are also grounded.

The capacitance between the input electrode and all other electrodes, except the output electrode, connected together is commonly known as the input capacitance. The capacitance between the output electrode and all other electrodes, except the input electrode, connected together is known as the output capacitance.

**Hum and noise** characteristics of high-fidelity audio amplifier tube types such as the 7025 and the 7199 are tested in an amplifier circuit such as that shown in Fig. 105. The output of the test circuit is fed into a low-noise amplifier. The bandwidth of this amplifier depends on the characteristic being measured. If hum alone is being tested, a relatively narrow bandwidth is used to include both the line frequency and the major harmonics generated by the tube under test. In noise or combination hum-and-noise measurements, the

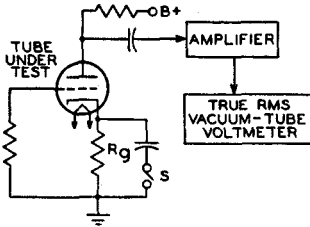

Fig. 105—Test circuit for measuring hum and noise characteristics of high-fidelity audio-amplifier tubes.

bandwidth is defined in the registration of the tube type.

The amplifier gain is calibrated so that the vacuum-tube voltmeter measures hum and noise in microvolts referred to the grid of the tube under test. A pentode can also be evaluated in this manner by the addition of a screen-

grid supply adequately bypassed at the tube screen-grid pin connection. Power-supply ripple at the plate of the tube under test must be negligible compared to its hum and noise output. Extraordinary shielding of both the test socket and the associated operating circuit is required to minimize capacitances between heater leads and high-impedance connections.

The test-circuit components are determined by the tube type being tested and the type of hum to be controlled. Heater-cathode hum can be eliminated from the measurement by closing the switch S. The circuit can also be made more or less sensitive to heater-grid hum by increasing or decreasing the grid resistance  $R_g$ . No circuit changes affect the component of magnetic hum generated by the tube.

# Application Guide for RCA Receiving Tubes

In the Application Guide on the following pages, RCA receiving tubes are classified in two ways: (a) by function, and (b) by structure (diode, triode, etc.). The functional classification covers 42 principal types of application, as listed below.

Tube types are grouped by structure under each classification; they are also keyed to indicate miniature, octal, nuvistor, duodecar, and novar types.

Triodes are designated as *low*, *medium*-, or *high-mu* types on the following basis: *low*, less than 10; *medium*, 10 or more, but less than 50; *high*, 50 or more. Where applicable, tubes are

designated as *sharp*-, *semiremote*, or *remote-cutoff* on the basis of the ratio, in per cent, of the negative control-grid voltage to the screen-grid voltage (or, for triodes, the plate voltage) as given in the characteristics or typical operation values. These terms are defined as follows: *sharp*, less than 10 per cent; *semiremote*, 10 or more, but less than 20 per cent; *remote*, 20 per cent or more.

For more complete data on these types, refer to the **Technical Data For RCA Receiving Tubes** starting on page 93.

## APPLICATIONS

- |  |   |   |
|--|---|---|
| 1. Audio-Frequency Amplifiers                    | 15. Frequency Dividers                      | 28. Oscillators   |
| 2. Automatic Gain Control (AGC and AVC) Circuits | 16. FM Detectors                            | 29. Phase Inverters   |
| 3. Bandpass Amplifiers (Color TV)                | 17. Gated Noise, AGC, and Sync Amplifiers   | 30. Phase Splitters   |
| 4. Burst Amplifiers                              | 18. Grounded-Grid RF Amplifiers             | 31. Radio-Frequency Amplifiers                              |
| 5. Cathode-Drive RF Amplifiers (Grounded-Grid)   | 19. Harmonic Generators                     | 32. Reactance Circuits                                      |
| 6. Color Killers                                 | 20. Horizontal-Deflection Circuits          | 33. Rectifiers  |
| 7. Color Matrixing Circuits                      | 21. Intermediate-Frequency Amplifiers       | 34. Regulators  |
| 8. Complex-Wave Generators                       | 22. Keyed AGC Amplifiers                    | 35. Sync Amplifiers   |
| 9. Converters                                    | 23. Limiters                                | 36. Sync Clippers   |
| 10. Dampers                                      | 24. Mixers—RF                               | 37. Sync Separators   |
| 11. Demodulators (Color TV)                      | 25. Mixer-Oscillators—RF                    | 38. Tuning Indicators                                       |
| 12. Detectors                                    | 26. Multivibrators                          | 39. Vertical-Deflection Circuits (Oscillator and Amplifier) |
| 13. DC Restorers                                 | 27. Noise Inverters (Noise Immune Circuits) | 40. Video Amplifiers  |

### 1. AUDIO-FREQUENCY AMPLIFIERS

#### *Voltage Amplifiers*

Medium-Mu Triode with Twin Diode  
• 6BF6

Medium-Mu Triode—Sharp-Cutoff Pentode  
• 11LQ8 • 7199†

Medium-Mu Twin Triode

• 5J6 • 7AU7 • 12SN7GTA  
• 6J6A • 9AU7 • 19J6  
• 6SN7GTB • 17CU5

• Miniature

○ Octal

△ Nuvistor

▲ Novar

† For high-fidelity equipment

**High-Mu Triode with Twin Diode**

- |        |         |          |
|--------|---------|----------|
| • 3AV6 | • 6BN8  | • 12AV6  |
| • 4AV6 | • 6CN7  | ◊ 12SQ7  |
| • 6AT6 | ◊ 6SQ7  | • 14GT8  |
| • 6AV6 | • 12AT6 | • 18FY6A |

**High-Mu Triode with Triple Diode**

- |       |        |        |
|-------|--------|--------|
| • 5T8 | • 6T8A | • 19T8 |
|-------|--------|--------|

**High-Mu Twin Triode**

- |           |           |         |
|-----------|-----------|---------|
| • 6EU7†   | • 12AZ7A  | • 20EZ7 |
| ◊ 6SL7GT  | • 12BZ7   | • 7025† |
| • 12AX7A† | ◊ 12SL7GT |         |

**Sharp-Cutoff Pentode**

- |          |          |         |
|----------|----------|---------|
| • 3DT6A* | • 6DT6A* | • 5879† |
| • 4DT6A* | • 6GX6*  | • 7543† |
| • 5GX6*  | • 6HZ6*  |         |

**Remote-Cutoff Pentode with Diode**

- |         |
|---------|
| • 12CR6 |
|---------|

*Power Amplifiers***Beam Power Tube**

- |          |              |          |
|----------|--------------|----------|
| • 5AQ5   | ◊ 6L6        | • 17CU5  |
| • 5CZ5   | ◊ 6L6GC†     | • 25C5   |
| ◊ 5V6GT  | ◊ 6V6        | • 25F5A  |
| • 6AQ5A  | ◊ 6V6GTA     | • 34GD5A |
| • 6AS5   | ◊ 6W6GT      | • 35C5   |
| • 6CM6   | ◊ 6Y6G       | ◊ 35L6GT |
| • 6CU5   | • 12AB5      | • 50B5   |
| • 6CZ5   | • 12AQ5      | • 50C5   |
| ◊ 6DG6GT | • 12CA5      | ◊ 50L6GT |
| • 6DS5   | • 12CU5/12CS | • 6973†  |
| ▲ 6GC5   | ◊ 12V6GT     | ◊ 7408†  |
| • 6HG5   | ◊ 12W6GT     |          |

**Beam Power Tube—Sharp-Cutoff Pentode**

- |         |          |          |
|---------|----------|----------|
| ‡ 6AL11 | ‡ 10AL11 | ‡ 12AL11 |
|---------|----------|----------|

**Power Pentode**

- |         |         |         |
|---------|---------|---------|
| • 6BQ5  | • 8BQ5  | • 50EH5 |
| • 6EH5  | • 12EH5 | • 60FX5 |
| ◊ 6F6   | • 12FX5 | • 7189† |
| • 6GK6  | • 25EH5 | ▲ 7868† |
| ◊ 6K6GT | • 35EH5 |         |

**Pentode—Beam Power Tube**

- |        |         |
|--------|---------|
| ‡ 6J10 | ‡ 13J10 |
|--------|---------|

**2. AUTOMATIC GAIN CONTROL CIRCUITS (AGC & AVC)****Diode—Sharp-Cutoff Pentode**

- |        |         |
|--------|---------|
| • 6KL8 | • 12KL8 |
|--------|---------|

**Diode—Remote-Cutoff Pentode**

- |        |         |
|--------|---------|
| • 6EQ7 | • 12EQ7 |
|--------|---------|

**Twin Diode—High-Mu Triode**

- |        |         |          |
|--------|---------|----------|
| • 3AV6 | • 6AV6  | • 12AV6  |
| • 4AV6 | • 6SQ7  | ◊ 12SQ7  |
| • 6AT6 | • 12AT6 | • 18FY6A |

**Medium-Mu Triode—Sharp-Cutoff Pentode**

- |         |         |         |
|---------|---------|---------|
| • 5AN8  | • 6BA8A | • 6GH8A |
| • 5GH8  | • 6BH8  | • 8BA8A |
| • 6AN8A | • 6CU8  | • 8BH8  |
| • 6AZ8  |         |         |

**High-Mu Triode—Sharp-Cutoff Pentode**

- |         |         |         |
|---------|---------|---------|
| • 6AW8A | • 6JV8  | • 8JV8  |
| • 6HF8  | • 8AW8A | • 10HF8 |

**Sharp-Cutoff Twin Pentode**

- |        |        |        |
|--------|--------|--------|
| • 3BU8 | • 4BU8 | • 6RU8 |
| • 3GS8 | • 4HS8 | • 6HS8 |
| • 3HS8 |        |        |

**3. BANDPASS AMPLIFIER (COLOR TV)**

- |         |        |         |
|---------|--------|---------|
| • 6AW8A | • 6LF8 | • 8AW8A |
| • 6HL8  | • 6KT8 |         |

**4. BURST AMPLIFIERS****Medium-Mu Triode—Sharp-Cutoff Pentode**

- |        |        |         |
|--------|--------|---------|
| • 5EA8 | • 6EA8 | • 6GH8A |
| • 5GH8 |        |         |

**Medium-Mu Triode—Semiremote-Cutoff Pentode**

- |        |
|--------|
| • 6LM8 |
|--------|

**High-Mu Triode with Twin Diodes**

- |        |        |
|--------|--------|
| • 6BN8 | • 8BN8 |
|--------|--------|

**5. CATHODE-DRIVE RF AMPLIFIERS (GROUNDED-GRID)****Medium-Mu Triode**

- |        |
|--------|
| • 6BC4 |
|--------|

**Medium-Mu Twin Triode**

- |         |         |         |
|---------|---------|---------|
| • 4BC8  | • 5BK7A | • 6BQ7A |
| • 4BQ7A | • 5BQ7A | • 6BS8  |
| • 4BS8  | • 6BC8  | • 6BZ7  |
| • 4BZ7  | • 6BK7A |         |

**High-Mu Triode**

- |        |        |         |
|--------|--------|---------|
| ▲ 2CW4 | • 6AB4 | ▲ 6DS4  |
| ▲ 2DS4 | ▲ 6CW4 | ▲ 13CW4 |

**High-Mu Twin Triode**

- |         |          |         |
|---------|----------|---------|
| • 6DT8  | • 12AZ7A | • 12DT8 |
| • 12AT7 |          |         |

**6. COLOR KILLERS****Quadruple Diode**

- |        |         |
|--------|---------|
| • 6JU8 | • 6JU8A |
|--------|---------|

• Miniature ‡ Duodecar ◊ Octal ▲ Nuvistor ▲ Novar \* Dual-control grids  
† For high-fidelity equipment



### 7. COLOR MATRIXING CIRCUITS

Medium-Mu Twin Triode

- 6CG7                      • 6GU7                      • 8FQ7
- 6FQ7                      • 8CG7                      • 12BH7A

### 8. COMPLEX-WAVE GENERATORS

High-Mu Twin Double-Plate Triode

- 12FQ8

Sharp-Cutoff Twin-Plate Tetrode—Diode

- 6FA7

Sharp-Cutoff Three-Plate Tetrode—Diode

- 6KM8

Three-Plate Tetrode—Medium-Mu Triode

- 6FH8

### 9. CONVERTERS

Medium-Mu Triode—Sharp-Cutoff Pentode

- 5EA8                      • 5X8                      • 6KZ8
- 5GH8                      • 6EA8                      • 6U8A
- 5KE8                      • 6GH8A                      • 6X8
- 5U8                      • 6KE8                      • 19X8

High-Mu Twin Triode

- 6DT8                      • 12AZ7A                      • 12DT8
- 12AT7

Sharp-Cutoff Pentode

- 3AU6                      • 6AU6A                      • 18GD6A
- 4AU6                      • 12AU6

Pentagrid

- 3BE6                      ◊ 6SA7                      ◊ 12SA7
- 6BA7                      • 12BE6                      • 18FX6A
- 6BE6

### 10. DAMPERS

Half-Wave (Diode)

- ◊ 6AU4GTA                      ◊ 6DM4                      ▲ 17BS3
- ◊ 6AX4GTB                      ▲ 6DW4                      ◊ 17D4
- ▲ 6AY3                      ◊ 6W4GT                      ◊ 17DE4
- ▲ 6BA3                      ◊ 12AX4GTA                      ◊ 19AU4
- ▲ 6BH3                      ◊ 12AX4GTB                      ▲ 22BH3
- ▲ 6BS3                      ▲ 12AY3                      ◊ 22DE4
- ◊ 6CQ4                      ▲ 12BS3                      ◊ 25AX4GTA
- ◊ 6DA4                      ◊ 12D4                      ▲ 17AY3
- ◊ 6DE4                      ◊ 17AX4GTA                      ▲ 17BH3

### 11. DEMODULATORS (COLOR TV)

Medium-Mu Twin Triode

- 12BH7A

- Miniature      ◊ Octal      ▲ Nuvistor      ▲ Novar      \* Dual-control grids

High-Mu Twin Triode

- 12AZ7A

Sharp-Cutoff Pentode

- 3BY6                      • 6GY6

Pentagrid Amplifier

- 6BY6                      • 6JH8

### 12. DETECTORS

Diode—Sharp-Cutoff Pentode

- 5AM8                      • 6AM8A
- 5AS8                      • 6AS8

Diode—Remote-Cutoff Pentode

- 6CR6                      • 12CR6                      • 12EQ7
- 6EQ7

Twin Diode

- 3AL5                      ◊ 6H6                      ◊ 12H6
- 6AL5                      • 12AL5

Twin Diode—High-Mu Triode

- 3AV6                      • 6CN7                      • 12AV6
- 4AV6                      ◊ 6SQ7                      ◊ 12SQ7
- 6AT6                      • 8BN8                      • 14GT8
- 6AV6                      • 12AT6                      • 18FY6A
- 6BN8

Triple Diode

- 6BJ7

Triple Diode—High-Mu Triode

- 5T8                      • 6T8A

Quadruple Diode

- 6JU8                      • 6JU8A

Sharp-Cutoff Pentode

- 3DT6A\*                      • 5GX6\*                      • 6GX6\*
- 4DT6A\*                      • 6DT6A\*                      • 6HZ6\*

### 13. DC RESTORERS

Diode—Sharp-Cutoff Pentode

- 5AM8                      • 6AM8A                      • 6AS8
- 5AS8

Triple Diode

- 6BJ7

### 14. DISCRIMINATORS

FM

Twin Diode

- 3AL5                      • 6AL5                      • 12AL5

Twin Diode—High-Mu Triode

- 6BN8                      • 14GT8

Triple Diode—High-Mu Triode

- 5T8                      • 6T8A                      • 19T8

**Beam Tube**

- 3BN6                      • 4BN6                      • 6BN6

**Beam Power Tube—Sharp-Cutoff Pentode**

- ‡ 6AL11    ‡ 6BF11    ‡ 12AL11    ‡ 17BF11

**Pentode—Beam Power Tube**

- ‡ 6J10                      ‡ 13J10

*FM Quadrature-Grid***Sharp-Cutoff Pentode**

- 3DT6A\*                  • 5GY6\*                  • 6GX6\*
- 4DT6A\*                  • 6DT6A\*                  • 6HZ6\*
- 5GX6\*

**Beam Tube**

- 3BN6                      • 4BN6                      • 6BN6

*Horizontal AFC***Twin Diode—High-Mu Triode**

- 6BN8                      • 8BN8                      • 8CN7
- 6CN7

**15. FREQUENCY DIVIDERS****High-Mu Twin Double-Plate Triode**

- 12FQ8

**16. FM DETECTORS**

(See 14. Discriminators)

**17. GATED NOISE, AGC, AND SYNC AMPLIFIERS****High-Mu Triode—Sharp-Cutoff Pentode**

- 6KA8                      • 8KA8                      • 8LC8
- 6LC8

**Sharp-Cutoff Pentode**

- 6GY6\*

**Sharp-Cutoff Twin Pentode**

- 3BU8                      • 4BU8                      • 6BU8
- 3GS8                      • 4HS8                      • 6HS8
- 3HS8

**Pentagrid Amplifier**

- 3BY6                      • 4CS6                      • 6CS6
- 3CS6                      • 6BY6

**18. GROUNDED-GRID RF AMPLIFIERS**

(See 5. Cathode-Drive RF Amplifiers)

**19. HARMONIC GENERATORS**

(See 8. Complex-Wave Generators)

**20. HORIZONTAL-DEFLECTION CIRCUITS***Oscillators***Medium-Mu Triode—Sharp-Cutoff Pentode**

- 5GH8                      • 6GH8A

**Medium-Mu Twin Triode**

- 6CG7                      • 8CG7                      • 12AU7A
- 6SN7GTB                  • 9AU7                      • 12BH7A
- 7AU7                      • 12SN7GTA

*Amplifiers***Beam Power Tube**

- 6AU5GT                  ▲ 6JG6                      ▲ 17GJ5
- 6AV5GA                  ▲ 6JG6A                    ▲ 17GJ5A
- 6BG6GA                  ▲ 6JT6                      ▲ 17GT5
- 6BQ6GTB/                  ▲ 6KM6                      • 17GW6
- 6CU6                      • 12AV5GA                  ▲ 17JB6
- 6CB5A                      • 12BQ6GTB/              ▲ 17JG6
- 6CD6GA                  12CU6                      ▲ 17JT6
- 6DQ5                      • 12DQ6B                  ▲ 22JF6
- 6DQ6B                      ▲ 12GT5                    ▲ 22JG6
- ▲ 6GJ5                      • 12GW6                    • 25AV5GA
- ▲ 6GT5                      ▲ 12JB6                    • 25BQ6GTB/
- 6GW6                      ▲ 12JT6                    25CU6
- ▲ 6JB6                      • 17BQ6GTB              • 25CD6GB
- ▲ 6JE6                      • 17DQ6B                  • 25DN6

**21. INTERMEDIATE-FREQUENCY AMPLIFIERS****Medium-Mu Triode—Sharp-Cutoff Tetrode**

- 5CQ8                      • 6CQ8

**Medium-Mu Triode—Sharp-Cutoff Pentode**

- 5AN8                      • 6AZ8                      • 6CU8
- 6AN8A                    • 6BH8

**High-Mu Triode—Sharp-Cutoff Pentode**

- 6AW8A                    • 6KV8                      • 10GN8
- 6GN8                      • 8AW8A                    • 10HF8
- 6HF8                      • 8GN8                      • 10JA8
- 6JV8                      • 8JV8                      • 11KV8
- 6KT8

**Sharp-Cutoff Pentode**

- 3AU6                      • 4JC6                      • 6DK6
- 3BC5                      • 4JD6•                      • 6EJ7
- 3CB6                      • 5EW6                      • 6EW6
- 3CF6                      • 6AG5                      • 6HS6
- 3DK6                      • 6AK5                      • 6JC6
- 3JC6                      • 6AU6A                    • 6JD6•
- 3JD6•                      • 6BC5                      • 12AU6
- 4AU6                      • 6CB6                      • 12AW6
- 4CB6                      • 6CB6A                    • 12DK6
- 4DE6                      • 6CF6                      • 18GD6A
- 4DK6                      • 6DC6                      • 19HS6
- 4EW6                      • 6DE6

• Miniature    ○ Octal    ▲ Nuvistor    ▲ Novar  
\* Dual-control grids    ‡ Duodecap

• Approaches semiremote-cutoff characteristics; used in first-if amplifier applications

**Sharp-Cutoff Pentode with Diode**

- 5AM8      • 6AM8A      • 6KL8
- 5AS8      • 6AS8      • 12KL8

**Semiremote-Cutoff Pentode**

- 3BZ6      • 5GM6      • 6HR6
- 3EH7      • 6BZ6      • 6JH6
- 4BZ6      • 6EH7      • 12BZ6
- 4EH7      • 6GM6      • 19HR6
- 4GM6

**Remote-Cutoff Pentode**

- 3BA6      • 12BA6      • 18FW6A
- 6BA6      • 18FW6

**Remote-Cutoff Pentode with Diode**

- 6EQ7      • 12EQ7

**22. KEYED AGC AMPLIFIERS**

(See 17. Gated Noise, AGC, and Sync Amplifiers)

**23. LIMITERS**

**Beam Tube**

- 3BN6      • 4BN6      • 6BN6

**Sharp-Cutoff Pentode**

- 3AU6      • 6AU6A      • 6HZ6
- 4AU6      • 6GX6      • 12AU6
- 5GX6      • 6HS6      • 19HS6

**Sharp-Cutoff Pentode with Diode**

- 6KL8      • 12KL8

**Power Pentode—Beam Power Tube**

- ‡ 6J10      † 13J10

**24. MIXERS—RF**

**Medium-Mu Twin Triode**

- 5J6      • 6J6A

**High-Mu Triode**

- △ 2CW4      △ 6CW4      △ 13CW4
- 6AB4

**25. MIXER-OSCILLATORS—RF**

**Medium-Mu Triode—Sharp-Cutoff Tetrode**

- 5CL8A      • 6CL8A      • 19CL8A
- 5CQ8      • 6CQ8

**Medium-Mu Triode—Sharp-Cutoff Pentode**

- 5AT8      • 5X8      • 6KZ8
- 5B8      • 6AT8A      • 6U8A
- 5BR8      • 6BR8A      • 6Z8
- 5CG8      • 6CG8A      • 9EA8
- 5EA8      • 6EA8      • 9U8
- 5FG7      • 6FG7      • 19EA8
- 5KE8      • 6HB7      • 19X8
- 5U8      • 6KE8

**High-Mu Twin Triode**

- 6DT8      • 12AT7      • 12DT8

**Triode-Hexode**

- ⊙ 6G8      ⊙ 12K8

**26. MULTIVIBRATORS**

**Medium-Mu Triode—Sharp-Cutoff Pentode**

- 5GH8      • 6GH8A

**Medium-Mu Twin Triode**

- 6CG7      • 7AU7      ⊙ 12SN7-
- 6GU7      • 8CG7      G1A
- ⊙ 6SN7GTB      • 9AU7
- 12AU7A

**High-Mu Twin Triode**

- 12AX7A

**27. NOISE INVERTERS (NOISE IMMUNE CIRCUITS)**

**High-Mu Triode—Sharp-Cutoff Pentode**

- 6KA8      • 8KA8      • 6LC8
- 6LC8

**Sharp-Cutoff Pentode**

- 6GY6\*

**28. OSCILLATORS**

*Radio Frequency—UHF*

**Medium-Mu Triode**

- 2AF4B      • 3AF4A      • 6AF4A
- △ 2DV4      • 3DZ4      △ 6DV4
- 2DZ4      • 6AF4      • 6DZ4

*Radio Frequency—VHF*

**Medium-Mu Twin Triode**

- 5J6      • 6J6A

**High-Mu Triode**

- 6AB4

**Power Triode**

- 6C4 (Class C)

*Low Frequency, Sweep Type*

**Medium-Mu Triode—Sharp-Cutoff Pentode**

- 5AN8      • 6BA8A      • 8AU8
- 6AN8A      • 6BH8      • 8BA8B
- 6AU8A      • 6CH8      • 8BH8
- 6AZ8

**High Mu Triode with Twin Diode**

- 6BN8      • 8BN8      • 8CN7
- 6CN7

**High-Mu Twin Triode**

- 12AX7A

**29. PHASE INVERTERS**

**Medium-Mu Triode—High-Mu Triode**

- 12DW7

• Miniature      ⊙ Octal      △ Nuvistor      ▲ Novar      \* Dual-control grids      † Duodecar

## Medium-Mu Twin Triode

- 6CG7                   • 7AU7
- 6GU7                   • 8CG7                   • 12AU7A
- 6SN7GTB           • 9AU7                   ○ 12SN7-GTA

## High-Mu Triode—Sharp-Cutoff Pentode

- 6AW8A               • 8AW8A               • 10GN8
- 6EB8                 • 8EB8                 • 10HF8
- 6GN8                 • 8GN8                 • 10JA8
- 6HF8

## High-Mu Twin Triode

- 6SL7GT             ○ 12SL7GT             • 7025
- 12AX7A

## 30. PHASE SPLITTERS

## Medium-Mu Triode—Sharp-Cutoff Tetrode

- 5CQ8                 • 6CQ8

## Medium-Mu Triode—Sharp-Cutoff Pentode

- 5AN8                 • 6BA8A               • 8BA8A
- 6AN8                 • 6CH8                 • 7199
- 6AZ8                 • 6CU8

## High-Mu Triode—Sharp-Cutoff Pentode

- 6AW8A               • 8AW8A

## 31. RADIO-FREQUENCY AMPLIFIERS

## Medium-Mu Triode

- 2BN4A               • 6BC4                 • 6BN4A
- 3BN4A

## Medium-Mu Triode—Sharp-Cutoff Tetrode

- 5CQ8                 • 6CQ8

## Medium-Mu Twin Triode

- 4BC8                 • 5BQ7A               • 6BS8
- 4BQ7A               • 5J6                   • 6BZ7
- 4BS8                 • 6BC8                 • 6J6A
- 4BZ7                 • 6BK7B               • 12AV7
- 5BK7A               • 6BQ7A

## High-Mu Triode

- △ 2CW4               • 3GK5                 • 6ER5
- △ 2DS4               • 3HM5/3HA5           • 6FH5
- 2ER5                 • 4GK5                 • 6FQ5A
- 2FH5                 • 6AB4                 • 6GK5
- 2GK5                 △ 6CW4                • 6HM5/6HA5
- 3ER5                 △ 6DS4                △ 13CW4
- 3FH5

## High-Mu Twin Triode

- 6DT8                 • 12AZ7A               • 12DT8

## Power Triode

- 6C4 (Class C)

• Miniature

○ Octal

## Sharp-Cutoff Tetrode

- 2CY5                 • 4CY5                 • 6FV6
- 3CY5                 • 6CY5

## Sharp-Cutoff Pentode

- 3AU6                 • 6AK5                 • 6DE6
- 3BC5                 • 6AU6A               ○ 6SH7
- 3CB6                 • 6BC5                 ○ 6SJ7
- 3CF6                 • 6BH6                 • 12AU6
- 4AU6                 • 6CB6                 • 12AW6
- 4CB6                 • 6CB6A               ○ 12SH7
- 4DE6                • 6CF6                 ○ 12SJ7
- 6AG5                 • 6DC6                 • 18GD6A

## Sharp-Cutoff Pentode with Diode

- 6KL8                 • 12KL8

## Remote-Cutoff Pentode

- 3BA6                 • 6BJ6                 • 12BA6
- 6BA6                 ○ 6SK7GT             • 18FW6A

## Remote-Cutoff Pentode with Diode

- 6EQ7                 • 12EQ7

## 32. REACTANCE CIRCUITS

## Medium-Mu Triode—Sharp-Cutoff Pentode

- 5AN8                 • 6BA8A               • 6CU8
- 6AN8A               • 6CH8                 • 8BA8A
- 6AZ8

## High-Mu Triode with Twin Diodes

- 6CN7                 • 8CN7

## High-Mu Triode—Sharp-Cutoff Pentode

- 6AW8A               • 8AW8A

## 33. RECTIFIERS

*Power-Supply Types—Vacuum*

## Half-Wave (Diode)

- 35W4                 • 36AM3B               • 50DC4
- 35Z5GT

## Full-Wave (Twin Diode)

- 3DG4                 ○ 5V3A                 • 6CA4
- 5AR4/GF34           ○ 5VG4                 • 6X4
- 5AS4A               ○ 5V4GA               ○ 6X5GT
- △ 5BC3                 ○ 5XG4                 • 12CA4
- 5DJ4                 ○ 5Y3GT               • 12X4
- 5U4G                 ○ 5Z4                   • 25CA4
- 5U4GB

*High-Voltage Types (For rf-rectifier or pulsed low-current applications)—Vacuum*

## Half-Wave (Diode)

- 1G3GT/               • 1V2                   • 2BJ2
- 1B3GT             • 1X2B                 • 3A2
- 1K3/1J3             • 2AV2                 ○ 3CA3

△ Nuvistor

▲ Novar

### 34. REGULATORS (HIGH VOLTAGE, LOW CURRENT)

Sharp-Cutoff Beam Triode  
 ○ 6BK4A      ○ 6BK4B

### 35. SYNC AMPLIFIERS

Medium-Mu Triode—Sharp-Cutoff Pentode  
 • 6AU8A      • 6CX8      • 8CX8  
 • 6AZ8      • 8AU8

Medium-Mu Twin Triode  
 • 6CG7      • 8CG7      • 12AU7A  
 • 7AU7

High-Mu Triode with Twin Diode  
 • 6CN7      • 8CN7

High-Mu Triode—Sharp-Cutoff Pentode  
 • 6AW8A      • 6JV8      • 8JV8  
 • 6HF8      • 8AW8A      • 10HF8

High-Mu Twin Triode  
 • 12BZ7

### 36. SYNC CLIPPERS

Medium-Mu Triode—Sharp-Cutoff Tetrode  
 • 5CQ8      • 6CQ8

Medium-Mu Triode—Sharp-Cutoff Pentode  
 • 5AN8      • 6AZ8      • 6CX8  
 • 6AN8A      • 6CH8      • 8CX8  
 • 6AU8A      • 6CU8      • 8AU8

High-Mu Triode—Sharp-Cutoff Pentode  
 • 6AW8A      • 6HF8      • 8JV8  
 • 6EB8      • 6JV8      • 10GN8  
 • 6GN8      • 8AW8A      • 10HF8  
 • 6GW8/  
 ECL86      • 8EB8      • 10JA8  
 • 8GN8

High-Mu Twin Triode  
 • 12BZ7

Sharp-Cutoff Twin Pentode  
 • 3BU8      • 4BU8      • 6BU8  
 • 3GS8      • 4HS8      • 6HS8  
 • 3HS8

Pentagrid Amplifier  
 • 3BY6      • 4CS6      • 6CS6  
 • 3CS6      • 6BY6

### 37. SYNC SEPARATORS

Medium-Mu Triode—Sharp-Cutoff Tetrode  
 • 5CQ8      • 6CQ8

Medium-Mu Triode—Sharp-Cutoff Pentode  
 • 5AN8      • 6AZ8      • 6HL8  
 • 5GH8      • 6CU8      • 6GH8A  
 • 6AN8A      • 6CX8      • 8AU8  
 • 6AU8A      • 6GH8      • 8CX8

Medium-Mu Twin Triode  
 • 6CG7      • 8CG7      • 12AU7A  
 • 7AU7

High-Mu Triode with Twin Diode  
 • 6CN7      • 8CN7

High-Mu Triode—Sharp-Cutoff Pentode  
 • 6AW8A      • 6KV8      • 8KA8  
 • 6EB8      • 6LC8      • 8LC8  
 • 6GN8      • 8AW8A      • 10GN8  
 • 6HF8      • 8EB8      • 10HF8  
 • 6JV8      • 8GN8      • 10JA8  
 • 6KA8      • 8JV8      • 11KV8

High-Mu Twin Triode  
 • 12BZ7

Sharp-Cutoff Twin Pentode  
 • 3BU8      • 4BU8      • 6BU8  
 • 3GS8      • 4GS8/4BU8      • 6HS8  
 • 3HS8      • 4HS8

Pentagrid Amplifier  
 • 3BY6      • 4CS6      • 6CS6  
 • 3CS6      • 6BY6

### 38. TUNING INDICATORS

Indicator with Triode Unit  
 6E5

Twin Indicator Units  
 ○ 6AF6G

### 39. VERTICAL-DEFLECTION CIRCUITS

*Oscillators and Amplifiers (Combined)*

Medium-Mu Triode—Low-Mu Triode  
 • 6DE7      • 10DE7      • 13DE7  
 • 6EW7

Medium-Mu Dual Triode  
 • 6CM7      • 8CM7      • 8CS7  
 • 6CS7

High-Mu Triode—Low-Mu Triode  
 • 6CY7      ▲ 6GF7      ▲ 10GF7  
 • 6DR7      ▲ 6GF7A      ○ 11CY7  
 • 6EA7      ○ 6GL7      • 13DR7  
 ○ 6EM7      • 10DR7      ○ 13EM7  
 ▲ 6FD7      ○ 10EM7      ▲ 13FD7  
 ▲ 13GF7

High-Mu Triode—Beam Power Tube  
 ▲ 6KY8      ▲ 15KY8      ▲ 15KY8A  
 ▲ 6KY8A

• Miniature

○ Octal

▲ Nuvistor

▲ Novar

*Amplifiers***Low-Mu Triode**

- 12B4A

**Medium-Mu Triode**

- 6S4A

**Beam Power Tube**

- 5AQ5      • 6AQ5A      • 6EM5
- 5CZ5      • 6CM6        • 8EM5
- ⊙ 5V6GT    • 6CZ5        • 12AQ5

**Power Pentode**

- ⊙ 6K6GT

**40. VIDEO AMPLIFIERS****Medium-Mu Triode—Sharp-Cutoff Pentode**

- 5AN8      • 6BH8        • 8AU8
- 6AN8A    • 6CU8        • 8BA8A
- 6AU8A    • 6CX8        • 8BH8
- 6AZ8      • 6HL8        • 8CX8
- 6BA8A    • 11LQ8

**High-Mu Triode—Sharp-Cutoff Pentode**

- 6AW8A    • 6KV8        • 10GN8
- 6EB8      • 6LF8        • 10HF8
- 6GN8      • 8AV8A      • 10JA8
- 6HF8      • 8EB8        • 11KV8
- 6JV8      • 8GN8        • 12KV8
- 6KT8      • 8JV8

**Sharp-Cutoff Pentode**

- 12BY7A    † 12HG7

**Sharp-Cutoff Pentode with Diode**

- 5AM8      • 6AM8A      • 6AS8
- 5AS8

**Beam Power Tube**

- 6BK5      • 25BK5

**Power Pentode**

- ⊙ 6AG7      • 6GK6        • 16GK6
- 6CL6

• Miniature

⊙ Octal

△ Nuvistor

‡ Diodecar

▲ Novar

For information on picture tubes, refer to the **RCA Picture Tube Characteristics Chart** at the end of the **Technical Data** section.

# Technical Data for RCA Tube Types

**T**HIS section contains technical descriptions of RCA tubes used in standard broadcast, FM, and television receivers, in audio amplifiers, and in many other diverse applications. It includes detailed data on current types, including characteristics curves in many cases. Essential information on types intended primarily for replacement use and on discontinued types in which there may still be some interest is given in chart form at the end of the section. Characteristics charts for RCA television picture tubes for replacement use and for RCA voltage-regulator and voltage-reference tubes are given in the following section.

In choosing tube types for the design of new electronic equipment, the designer should refer to the **Application Guide for RCA Receiving Tubes** in the pages immediately preceding this section.

Tube types are listed in this section according to the numerical-alphabetical-numerical sequence of their type designations. For **Key: Basing Diagrams**, see inside back cover.

This edition of the **RCA Receiving Tube Manual** features an all-inclusive "Index to RCA Receiving Tubes." Located on page 561 of the manual, this index includes all active, replacement, and discontinued tube types and gives the page number on which the data for each type are given. For ready location of any specific type, the reader is urged to consult the index before referring to the formal data section or the "RCA Types for Replacement Use" table.

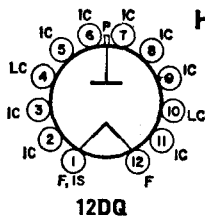

## HALF-WAVE VACUUM RECTIFIER

Duodecar type used to supply power to the anode of the picture tube in television receivers. Outline 9A, **Outlines** section. Tube requires duodecar twelve-contact socket and may be mounted in any position. Socket

# 1AD2

terminals 4 and 10 may be used as tie points for components at or near filament potential. Filament volts (ac/dc), 1.25; amperes, 0.2.

### Pulsed Rectifier

For operation in a 525-line, 30-frame system

<b>MAXIMUM RATINGS</b> (Design-Maximum Values):		
Peak Inverse Plate Voltage#	26000*max	volts
Peak Plate Current	50 max	mA
Average Plate Current	0.5 max	mA

<b>CHARACTERISTICS, Instantaneous Value:</b>		
Tube Voltage Drop for plate current of 7 mA	225	volts

# The duration of the voltage pulse must not exceed 15 per cent of one horizontal scanning cycle. In a 525-line, 30-frame system, 15 per cent of one horizontal scanning cycle is 10 microseconds.

\* The dc component must not exceed 22000 volts.

**HALF-WAVE VACUUM RECTIFIER**

**1G3GT/  
1B3GT**

Glass octal type used in high-voltage, low-current applications such as the rectifier in a high-voltage, rf-operated power supply or as a rectifier of high-voltage pulses produced in television scanning systems.

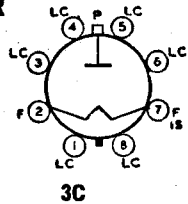

**3C**

Filament Voltage (ac/dc) .....	1.25*	volts
Filament Current .....	0.2	ampere
Direct Interelectrode Capacitance (Approx.):		
Plate to Filament and Internal Shield .....	1.3	pF

\* Under no circumstances should the filament voltage be less than 1.05 volts or greater than 1.45 volts.

**Pulsed Rectifier**

For operation in a 525-line, 30-frame system

<b>MAXIMUM RATINGS (Design-Maximum Values):</b>		
Peak Inverse Plate Voltage# .....	26000*max	volts
Peak Plate Current .....	50 max	mA
Average Plate Current .....	0.5 max	mA
<b>CHARACTERISTICS, Instantaneous Value:</b>		
Tube Voltage Drop for plate current of 7 mA .....	100	volts

**Radio-Frequency Rectifier**

<b>MAXIMUM RATINGS (Design-Maximum Values):</b>		
Peak Inverse Plate Voltage .....	33000 max	volts
Peak Plate Current .....	35 max	mA
Average Plate Current .....	1.1 max	mA
Frequency Range of Supply Voltage .....	1.5 to 100	kc/s

# The duration of the voltage pulse must not exceed 15 per cent of one horizontal scanning cycle. In a 525-line, 30-frame system, 15 per cent of one horizontal scanning cycle is 10 microseconds.

• The dc component must not exceed 22000 volts.

**Installation and Application**

Type 1G3GT/1B3GT requires an octal socket and may be mounted in any position. Plate connection is cap at top of bulb. Socket terminals 1, 3, 4, 5, 6, and 8 may be connected to socket terminal 7 or to a corona shield which is connected to socket terminal 7. Socket terminals 4 and 6 may be used as tie points for components at or near filament potential. This type may be supplied with pins 1, 4, and/or 6 omitted. Outline 14B, Outlines section.

The high voltages at which the 1G3GT/1B3GT is operated are very dangerous. Great care should be taken to prevent coming in contact with these high voltages. In those circuits where the filament circuit is not grounded, the filament circuit operates at dc potentials which can cause fatal shock. Extreme precautions must be taken when the filament voltage is measured. These precautions must include safeguards which definitely eliminate all hazards to personnel. The filament transformer, where it is of the iron-core or the air-core type, must be sufficiently insulated.

The voltages employed in some television receivers and other high-voltage equipment may be sufficiently high to cause high-voltage rectifier tubes such as the 1G3GT/1B3GT to produce soft X-rays which can constitute a health hazard unless the tubes are adequately shielded. Relatively simple shielding should prove adequate, but the need for this precaution should be considered.



**HALF-WAVE VACUUM RECTIFIER**

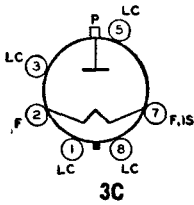

Glass octal type used as a rectifier of high-voltage pulses produced in the scanning systems of black-and-white television receivers. Tube requires octal socket and may be mounted in any position. Plate connection is cap at top of bulb. Socket terminals 1, 3, 4, 5, 6, and 8 may be connected to socket terminal 7 or to a corona shield which is connected to socket terminal 7. Socket terminals 4 and 6 may be used as tie points for components at or near filament potential. Outline 14B, **Outlines** section. For high-voltage considerations, see type 1G3GT/1B3GT.

**1K3/  
1J3**

3C

Filament Voltage (ac/dc)	1.25*	volts
Filament Current	0.2	ampere
Direct Interelectrode Capacitance (Approx.):		
Plate to Filament and Internal Shield	1.6	pF

\* Under no circumstances should the filament voltage be less than 1.05 volts or greater than 1.45 volts.

**Pulsed Rectifier**

For operation in a 525-line, 30-frame system

<b>MAXIMUM RATINGS</b> (Design-Maximum Values):		
Peak Inverse Plate Voltage#	26000*max	volts
Peak Plate Current	50 max	mA
Average Plate Current	0.5 max	mA

<b>CHARACTERISTICS, Instantaneous Value:</b>		
Tube Voltage Drop for plate current of 7 mA	225	volts

# The duration of the voltage pulse must not exceed 15 per cent of one horizontal scanning cycle. In a 525-line, 30-frame system, 15 per cent of one horizontal scanning cycle is 10 microseconds.

\* The dc component must not exceed 22000 volts.

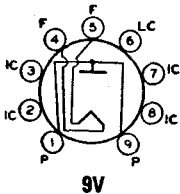

**HALF-WAVE VACUUM RECTIFIER**

Miniature type used in high voltage, low-current applications such as the rectifier in high-voltage, pulse-operated voltage-doubling power supplies for kinescopes. The very low power required by the filament permits the use of a rectifier transformer having small size and light weight.

**1V2**

Filament Voltage (ac)	0.625*	volt
Filament Current	0.3	ampere
Direct Interelectrode Capacitance:		
Plate to Filament (Approx.)	0.8	pF

\* Under no circumstances should the filament voltage be less than 0.525 volt or greater than 0.725 volt.

**Pulsed Rectifier**

For operation in a 525-line, 30-frame system

<b>MAXIMUM RATINGS</b> (Design-Maximum Values):		
Peak Inverse Plate Voltage*	8250*max	volts
Peak Plate Current	11 max	mA
Average Plate Current	0.6 max	mA

\* The duration of the voltage pulse must not exceed 15 per cent of one horizontal scanning cycle. In a 525-line, 30-frame system, 15 per cent of one horizontal scanning cycle is 10 microseconds.

\* The dc component must not exceed 7000 volts.

**Installation and Application**

Type 1V2 requires a miniature nine-contact socket and may be mounted in any position. The socket should be made of material having low leakage and should have adequate insulation between its filament and plate terminals to withstand the maximum peak inverse plate voltage. To provide the required insulation in miniature nine-contact sockets designed with a cylindrical center shield, it is necessary to remove the center shield. In addition, socket terminals 2, 3, 7, and 8 shall not be used. Socket terminal 6 may be used as a tie point for components at or near filament potential. Outline 6B, **Outlines** section.

The filament is of the coated type and is designed for operation at 0.625 volt. The filament windings on the pulse transformer should be adjusted to provide the rated voltage under average line-voltage conditions. When the filament voltage is measured, it is recommended that an rms voltmeter of the thermal type be used. The meter and its leads must be insulated to withstand 15000 volts and the stray capacitances to ground should be minimized.

The high voltages at which the 1V2 is operated are very dangerous. Great care should be taken to prevent coming in contact with these high voltages. Particular care against fatal shock should be taken in measuring the filament voltage in those circuits where the filament is not grounded. Precautions must include safeguards which definitely eliminate all hazards to personnel.

**HALF-WAVE VACUUM RECTIFIER**

**1X2B**

Miniature type used in high-voltage, low-current applications such as the rectifier in a high-voltage, rf-operated power supply, or as the rectifier of high-voltage pulses produced in television scanning systems. Outline 7A,

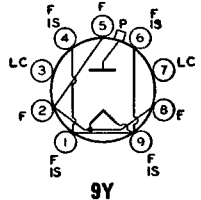

**Outlines** section. Tube requires miniature nine-contact socket and may be mounted in any position. Socket terminals 3 and 7 may be used as tie points for components at or near filament potential. For high-voltage considerations, refer to type 1G3GT/1B3GT.

Filament Voltage (ac) .....	1.25*	volts
Filament Current .....	0.2	ampere
Direct Interelectrode Capacitance:		
Plate to Filament and Internal Shield (Approx.) .....	1.0	pF

\* Under no circumstances should the filament voltage be less than 1.05 volts or greater than 1.45 volts.

**Pulsed Rectifier**

For operation in a 525-line, 30-frame system

**MAXIMUM RATINGS** (Design-Maximum Values):

Peak Inverse Plate Voltage* .....	22000 max	volts
Peak Plate Current .....	45 max	mA
Average Plate Current .....	0.5 max	mA

**CHARACTERISTICS**, Instantaneous Value:

Tube Voltage Drop for plate current of 7 mA .....	100	volts
---	-----	-------

\* The dc component must not exceed 18000 volts.

**HALF-WAVE VACUUM RECTIFIER**

**2AH2**

Duodecar type used to supply high voltage to the anode of picture tubes in television receivers. Outline 9A, **Outlines** section. Tube requires 12-contact socket and may be mounted in any position. Socket terminals 2,

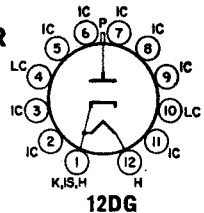

3, 5, 6, 7, 8, 9, and 11 should not be used as tie points; terminals 4 and 10 may

be used as tie points for components at or near cathode potential. For high-voltage and X-ray safety considerations, refer to type 1G3GT/1B3GT. Heater volts (ac/dc), 2.5; amperes, 0.3.

**Pulsed Rectifier**

For operation in a 525-line, 30-frame system

**MAXIMUM RATINGS (Design-Maximum Values):**

Peak Inverse Plate Voltage*	30000*max	volts
Peak Plate Current	80 max	mA
Average Plate Current	1.5 max	mA

**CHARACTERISTICS, Instantaneous Value:**

Tube Voltage Drop for plate current of 7 mA	100	volts
---	-----	-------

- \* The duration of the voltage pulse must not exceed 15 per cent of one horizontal scanning cycle. In a 525-line, 30-frame system, 15 per cent of one horizontal scanning cycle is 10 microseconds.
- The dc component must not exceed 24000 volts.

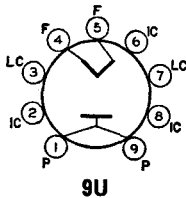

9U

**HALF-WAVE VACUUM RECTIFIER**

Miniature type used in high voltage, low-current rectifier applications such as pulse-operated, focus-rectifier circuits in color television receivers. The filament of the tube can be operated directly across the filament winding

**2AV2**

of the horizontal-output transformer without a series voltage-dropping resistor. Outline 6B, **Outlines section.** For installation and application data, see type 1V2.

Filament Voltage (ac)	1.8	volts
Filament Current	0.225	amps
Direct Interelectrode Capacitance (Approx.):		
Plate to Filament	0.8	pF

**Pulsed Rectifier**

For operation in a 525-line, 30-frame system

**MAXIMUM RATINGS (Design-Maximum Values):**

Peak Inverse Plate Voltage*	8250**	volts
Peak Plate Current	50	mA
Average Plate Current	0.6	mA

**CHARACTERISTICS, Instantaneous Value:**

Tube Voltage Drop for plate current of 1 mA	20	volts
---	----	-------

\* The duration of the voltage pulse must not exceed 15 per cent of one horizontal scanning cycle. In a 525-line, 30-frame system, 15 per cent of one horizontal scanning cycle is 10 microseconds.

\*\* Under no circumstances should this absolute value be exceeded; the dc component must not exceed 7000 volts.

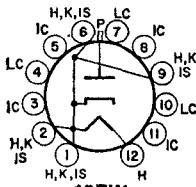

12EW

**HALF-WAVE VACUUM RECTIFIER**

Duodecar type used to supply high voltage to the anode of picture tubes in television receivers. Outline 9B, **Outlines section.** Tube requires duodecar twelve-contact socket and may be mounted in any position. Socket

**2AS2**

terminals 4, 7, and 10 may be used as tie points for components at or near heater potential. For high-voltage and X-ray safety considerations, refer to type 1G3GT/1B3GT. Heater volts (ac/dc), 2.5; amperes, 0.33.

**Pulsed Rectifier**

For operation in a 525-line, 30-frame system

**MAXIMUM RATINGS (Design-Maximum Values):**

Peak Inverse Plate Voltage <sup>□</sup> .....	30000*max	volts
Peak Plate Current .....	80 max	mA
Average Plate Current .....	1.5 max	mA

**CHARACTERISTICS, Instantaneous Value:**

Tube Voltage Drop for plate current of 7 mA .....	100	volts
---	-----	-------

□ The duration of the voltage pulse must not exceed 15 per cent of one horizontal scanning cycle. In a 525-line, 30-frame system, 15 per cent of one horizontal scanning cycle is 10 microseconds.

• The dc component must not exceed 24000 volts.

**HALF-WAVE VACUUM RECTIFIER**

**2BJ2**

Miniature type used as a rectifier in high-voltage circuits of transistorized black-and-white television receivers. Outline 7A, **Outlines** section. Tube requires miniature socket and may be mounted in any position. The base

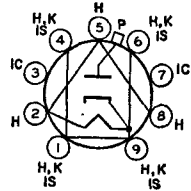

**9RT**

pins of the 2BJ2 fit the novel nine-contact socket. Socket terminals 3 and 7 should not be used as tie points for external-circuit connections. For high-voltage and X-ray safety considerations, refer to type 1G3GT/1B3GT. Heater volts (ac/dc), 2.3; amperes, 0.3.

**Pulsed Rectifier**

For operation in a 525-line, 30-frame system

**MAXIMUM RATINGS (Design-Maximum Values):**

Peak Inverse Plate Voltage* .....	20000 max	volts
Peak Plate Current .....	80 max	mA
Average Plate Current .....	1 max	mA

**CHARACTERISTICS, Instantaneous Value:**

Tube Voltage Drop for plate current of 7 mA .....	80	volts
---	----	-------

\* The duration of the voltage pulse must not exceed 15 per cent of one horizontal scanning cycle. In a 525-line, 30-frame system, 15 per cent of one horizontal cycle is 10 microseconds.

**HALF-WAVE VACUUM RECTIFIER**

**3A3/  
3B2**

Glass octal type used as rectifier of high-voltage pulses produced in the scanning systems of color television receivers. Outline 14E, **Outlines** section. Tube requires octal socket and may be mounted in any position.

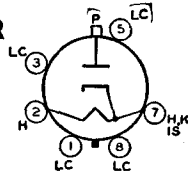

**8EZ**

Socket terminals 1, 3, 4, 5, 6, and 8 may be connected to socket terminal 7. Socket terminals 4 and 6 may be used as tie points for components at or near heater potential. For high-voltage considerations, see type 1G3GT/1B3GT.

Heater Voltage (ac) .....	3.15*	volts
Heater Current .....	0.22	ampere
Direct Interelectrode Capacitance (Approx.):		
Plate to Heater, Cathode, and Internal Shield .....	1.5	pF

\* Under no circumstances should the heater voltage be less than 2.65 volts or greater than 3.65 volts.

**Pulsed Rectifier**

For operation in a 525-line, 30-frame system

**MAXIMUM RATINGS (Design-Maximum Values):**

Peak Inverse Plate Voltage*	30000 max	volts
Peak Plate Current	88 max	mA
Average Plate Current	1.7 max	mA

\* The duration of the voltage pulse must not exceed 15 per cent of one horizontal scanning cycle. In a 525-line, 30-frame system, 15 per cent of one horizontal scanning cycle is 10 microseconds.

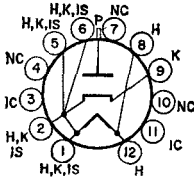

**12FV**

**HALF-WAVE VACUUM RECTIFIER**

Duodecar type used to supply high voltage to the anode of picture tubes in television receivers. Outline 9B, **Outlines** section. Tube requires duodecar twelve-contact socket and may be mounted in any position. For high-

voltage and X-ray safety considerations, refer to type 1G3GT/1B3GT. Heater volts (ac/dc), 3.15; amperes 0.22.

**3AT2**

**Pulsed Rectifier**

For operation in a 525-line, 30-frame system

**MAXIMUM RATINGS (Design-Maximum Values):**

Peak Inverse Plate Voltage*	30000 max	volts
Peak Plate Current	88 max	mA
Average Plate Current	1.7 max	mA

\* The duration of the voltage pulse must not exceed 15 per cent of one horizontal scanning cycle. In a 525-line, 30-frame system, 15 per cent of one horizontal scanning cycle is 10 microseconds.

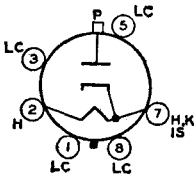

**8EZ**

**HALF-WAVE VACUUM RECTIFIER**

Glass octal type used as rectifier of high-voltage pulses produced in the scanning system of television receivers. Outline 14B, **Outlines** section. Tube requires octal socket and may be mounted in any position. Heater volts (ac/dc), 3.15; amperes, 0.22.

**3AW3**

**Pulsed Rectifier**

For operation in a 525-line, 30-frame system

**MAXIMUM RATINGS (Design-Maximum Values):**

Peak Inverse Plate Voltage*	30000 max	volts
Peak Plate Current	88 max	mA
Average Plate Current	1.7 max	mA

\* The duration of the voltage pulse must not exceed 15 per cent of one horizontal scanning cycle. In a 525-line, 30-frame system, 15 per cent of one horizontal scanning cycle is 10 microseconds.

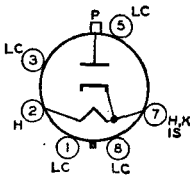

**8MH**

**HALF-WAVE VACUUM RECTIFIER**

Glass octal type used as a rectifier in high-voltage circuits of color television receivers. Outline 14E, **Outlines** section. Tube requires octal socket and may be mounted in any position. Socket terminals 1, 3, 4, 5, 6, and 8

**3CA3**

may be connected to terminal 7 or to a corona shield which connects to terminal 7. Socket terminals 4 and 6 may be used as tie points at or near cathode potential.

Heater Voltage (ac) .....	3.6	volts
Heater Current .....	0.225	ampere
Direct Interelectrode Capacitance (Approx.):		
Plate to Heater, Cathode, and Internal Shield .....	1.6	pF

**Pulsed Rectifier**

For operation in a 525-line, 30-frame system

**MAXIMUM RATINGS** (Design-Maximum Values):

Peak Inverse Plate Voltage* .....	30000	volts
Peak Plate Current .....	100	mA
Average Plate Current .....	2	mA

**CHARACTERISTICS**, Instantaneous Value:

Tube Voltage Drop for plate current of 11 mA .....	100	volts
--	-----	-------

\* The duration of the voltage pulse must not exceed 15 per cent of one scanning cycle. In a 525-line, 30-frame system, 15 per cent of one horizontal scanning cycle is 10 microseconds.

**Installation and Application**

The high voltages at which the 3CA3 is operated are very dangerous. Great care should be taken during the adjustment of circuits. The tube and its associated apparatus, especially all parts which may be at high potential with respect to ground, should be housed in a protective enclosure. The protective housing should be designed with interlocks so that personnel cannot possibly come in contact with any high-potential point in the electrical system. The interlock devices should function to break the primary circuit of the high-voltage supply when any gate or door on the protective housing is opened, and should prevent the closing of this primary circuit until the door is locked again.

It should be noted that high voltages may appear at normally low-potential points in the circuit as a result of capacitor breakdown or incorrect circuit connections. Therefore, before any part of the circuit is touched, the power-supply switch should be turned off and both terminals of any capacitor should be grounded.

Operation of the 3CA3 with a plate voltage above approximately 16000 volts (absolute value) results in the production of X-rays which can constitute a health hazard on prolonged exposure at close range unless the tube is adequately shielded. Relatively simple shielding should prove adequate, but the need for this precaution should be considered.

**FULL-WAVE VACUUM RECTIFIER**

**3DG4**

Glass octal type used as power supply in television receivers and other equipment having high dc requirements. Outline 19E, **Outlines** section. Tube requires octal socket and may be operated in any position. It is especially important that this tube, like other power-handling tubes, be adequately ventilated. For discussion of Rating Chart, refer to **Interpretation of Tube Data**. Filament volts (ac/dc), 3.3; amperes, 3.8.

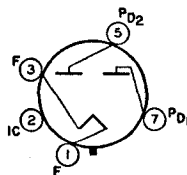

**7DK**

especially important that this tube, like other power-handling tubes, be adequately ventilated. For discussion of Rating Chart, refer to **Interpretation of Tube Data**. Filament volts (ac/dc), 3.3; amperes, 3.8.

**Full-Wave Rectifier**

**MAXIMUM RATINGS** (Design-Maximum Values):

Peak Inverse Plate Voltage .....	1050 max	volts
Peak Plate Current (Per Plate) .....	1.2 max	amperes
Hot-Switching Transient Plate Current (Per Plate) .....	6.5 max	amperes

AC Plate Supply Voltage (Per Plate, rms) .....  
 DC Output Current (Per Plate) .....  
 Bulb Temperature (at hottest point on bulb surface) .....

See Rating Chart  
 See Rating Chart  
 200 max °C

RATING CHART

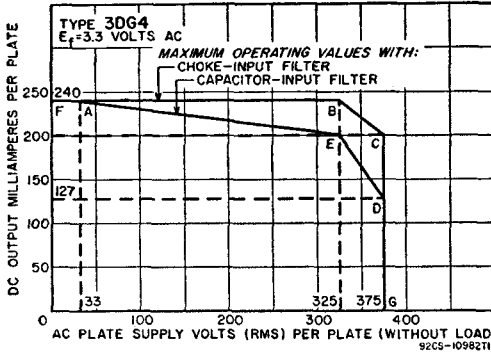

**TYPICAL OPERATION WITH CAPACITOR INPUT TO FILTER:**

AC Plate-to-Plate Supply Voltage (rms) .....	550	volts
Filter-Input Capacitor* .....	40	$\mu$ F
Effective Plate-Supply Impedance per Plate .....	32	ohms
DC Output Voltage at Input to Filter (Approx.): At full-load current of 350 mA .....	300	volts

**CHARACTERISTICS:**

Tube Voltage Drop for plate current of 350 mA (per plate) .....	25	volts
---	----	-------

\* Higher values of capacitance than indicated may be used, but the effective plate-supply impedance may have to be increased to prevent exceeding the maximum rating for peak plate current.

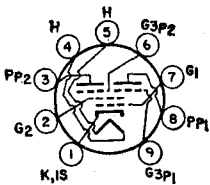

**SHARP-CUTOFF TWIN PENTODE**

Miniature type used as combined sync separator, sync clipper, and agc amplifier tube in television receivers employing series-connected heater strings. Outline 6E, Outlines section. Tube requires miniature nine-contact socket and may be mounted in any position.

**3GS8**

Heater Voltage (ac/dc) .....	3.15	volts
Heater Current .....	0.6	ampere
Heater Warm-Up Time (Average) .....	11	seconds
Peak Heater-Cathode Voltage: Heater negative with respect to cathode .....	200 max	volts
Heater positive with respect to cathode .....	200*max	volts
Direct Interelectrode Capacitances: Grid No.3 to Plate (Each Unit) .....	2	pF
Grid No.1 to All Other Electrodes .....	6	pF
Grid No.3 to All Other Electrodes (Each Unit) .....	3.8	pF
Plate to All Other Electrodes (Each Unit) .....	3.2	pF
Grid No.3 of Unit No.1 to Grid No.3 of Unit No.2 .....	0.015 max	pF

\* The dc component must not exceed 100 volts.

Class A<sub>1</sub> Amplifier

## MAXIMUM RATINGS (Design-Maximum Values):

Plate Voltage (Each Unit) .....	300 max	volts
Grid-No.3 (Suppressor-Grid) Voltage (Each Unit):		
Peak positive value .....	50 max	volts
DC negative value .....	-50 max	volts
DC positive value .....	3 max	volts
Grid-No.2 (Screen-Grid) Voltage .....	150 max	volts
Grid-No.1 (Control-Grid) Voltage, Negative bias value .....	-50 max	volts
Cathode Current .....	12 max	mA
Grid-No.2 Input .....	0.75 max	watt
Plate Dissipation (Each Unit) .....	1.1 max	watts

## CHARACTERISTICS: With Both Units Operating

Plate Voltage (Each Unit) .....	100	100	volts
Grid-No.3 Voltage (Each Unit) .....	-10	0	volts
Grid-No.2 Voltage .....	67.5	67.5	volts
Grid-No.1 Voltage .....	"	"	volts
Plate Current (Each Unit) .....	—	2	mA
Grid-No.2 Current .....	6	3.6	mA
Cathode Current .....	6.1	7.7	mA

## With One Unit Operating\*

Plate Voltage .....	100	100	volts
Grid-No.3 Voltage .....	0	0	volts
Grid-No.2 Voltage .....	67.5	67.5	volts
Grid-No.1 Voltage .....	0	"	volts
Grid-No.3 Transconductance .....	—	270	μmhos
Grid-No.1 Transconductance .....	1200	—	μmhos
Plate Current .....	—	2	mA
Grid-No.3 Voltage (Approx.) for plate current of 100 μA .....	—	-3.7	volts
Grid-No.1 Voltage (Approx.) for plate current of 100 μA .....	—	-2	volts

## MAXIMUM CIRCUIT VALUES:

Grid-No.3-Circuit Resistance (Each Unit) .....	0.5 max	megohm
Grid-No.1-Circuit Resistance .....	0.5 max	megohm

- Adjusted to give a dc grid-No.1 current of 100 microamperes.
- With plate and grid No.3 of the other unit connected to ground.

## DUAL TRIODE

4HC7

Duodecar type used for sync clipper and agc-amplifier service in television receivers. Outline 30E, Outlines section. Tube requires duodecar twelve-contact socket and may be mounted in any position. Heater volts (ac//dc),

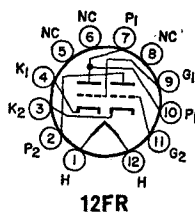

12FR

4.2; amperes, 0.6; warm-up time, 11 seconds; peak heater-cathode volts, 200 (the dc component must not exceed 100 volts when the heater is positive with respect to the cathode).

Class A<sub>1</sub> Amplifier

## MAXIMUM RATINGS (Design-Maximum Values):

	Unit No.1 330 max	Unit No.2 330 max	volts
Plate Voltage .....			
Grid Voltage:			
Positive-bias value .....	0	0	
Negative-bias value .....	-100 max	-100 max	volts
Peak Positive-Pulse Grid Voltage .....	60 max	—	volts
Plate Dissipation .....	3 max	1.2 max	watts

## CHARACTERISTICS:

Plate Voltage .....	150	150	volts
Grid Voltage .....	-1	-1	volt
Amplification Factor .....	23	100	
Plate Resistance (Approx.) .....	5200	53000	ohms
Transconductance .....	4400	1900	μmhos
Plate Current .....	18	1	mA
Grid Voltage (Approx.) for plate current of 10 μA .....	-13	-2.2	volts



**MAXIMUM CIRCUIT VALUE:**

Grid-Circuit Resistance ..... 5 max 5 max megohms

\*\* An adequate bias resistor or other means is required to protect the tube in the absence of excitation.

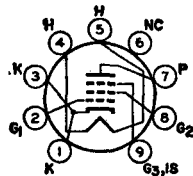

9PM

**SEMIREMOTE-CUTOFF PENTODE**

Miniature type with frame grid used in the if-amplifier stages of television receivers employing series-connected heater strings. Outline 6B, **Outlines** section. Tube requires miniature nine-contact socket and may be mounted

**4HT6**

in any position. Heater volts (ac/dc), 4.2; amperes, 0.45; warm-up time (average), 11 seconds; peak heater-cathode volts, 200 (the dc component must not exceed 100 volts when the heater is positive with respect to the cathode).

**Class A<sub>1</sub> Amplifier**

**MAXIMUM RATINGS (Design-Maximum Values):**

Plate Voltage .....	250 max	volts
Grid-No.2 (Screen-Grid) Supply Voltage .....	250 max	volts
Grid-No.2 Voltage .....	See curve page 80	
Grid-No.1 (Control-Grid) Voltage, Negative-bias value .....	-50 max	volts
Cathode Current .....	25 max	mA
Plate Dissipation .....	2.5 max	watts
Grid-No.2 Input:		
For grid-No.2 voltages up to 125 volts .....	0.6 max	watt
For grid-No. 2 voltages between 125 and 250 volts .....	See curve page 80	

**CHARACTERISTICS:**

Plate Supply Voltage .....	125	volts
Grid No.3 (Suppressor Grid) .....	Connected to cathode at socket	
Grid-No.2 Supply Voltage .....	125	volts
Cathode-Bias Resistor .....	56	ohms
Plate Resistance (Approx.) .....	0.143	megohm
Transconductance .....	14000	μmhos
Plate Current .....	15	mA
Grid-No.2 Current .....	4	mA
Grid-No.1 Voltage (Approx.) for transconductance of 100 μmhos .....	-4.5	volts

**MAXIMUM CIRCUIT VALUES:**

Grid-No.1-Circuit Resistance:		
For fixed-bias operation .....	0.25 max	megohm
For cathode-bias operation .....	1 max	megohm

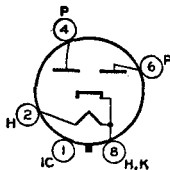

5DA

**FULL-WAVE VACUUM RECTIFIER**

Glass octal type used as power supply in television receiver and other equipment having high dc requirements. Outline 13F, **Outlines** Section. Tube requires octal socket and may be mounted in any position. It is especially important that this tube, like other power-handling tubes, be adequately ventilated. Heater volts (ac/dc), 5; amperes, 1.9.

**5AR4/  
GZ34**

especially important that this tube, like other power-handling tubes, be adequately ventilated. Heater volts (ac/dc), 5; amperes, 1.9.

**Full-Wave Rectifier**

**MAXIMUM RATINGS (Design-Maximum Values):**

Peak Inverse Plate Voltage .....	1700 max	volts
Peak Plate Current (per plate) .....	825 max	mA
Hot-Switching Transient Plate Current (per plate) .....	3.7 max	amperes
AC Plate-Supply Voltage (per plate, rms, without load) .....	See Rating Chart	
DC Output Current (per plate) .....	See Rating Chart	

**TYPICAL OPERATION WITH CAPACITOR**

**INPUT TO FILTER:**

AC Plate-to-Plate Supply Voltage (rms) .....	450	550	volts
Effective Plate-Supply Impedance per Plate .....	160	200	ohms
DC Output Current .....	225	160	mA
DC Output Voltage at Input to Filter .....	475	620	volts

**TYPICAL OPERATION WITH CHOKE**

**INPUT TO FILTER:**

AC Plate-to-Plate Supply Voltage (rms) .....	450	550	volts
Filter Input Choke .....	10	10	henries
DC Output Current .....	250	225	mA
DC Output Voltage at Input to Filter .....	375	465	volts

**CHARACTERISTICS, Instantaneous Value:**

Tube Voltage Drop for plate current of 225 mA (per plate) .....	—	17	volts
--	---	----	-------

**RATING CHART**

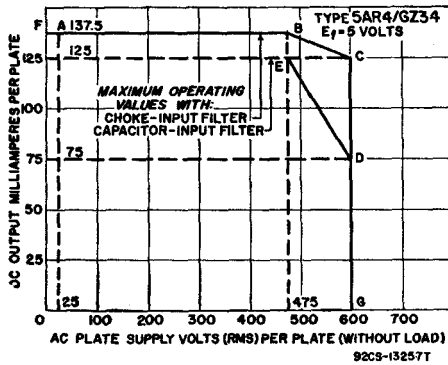

**FULL-WAVE VACUUM RECTIFIER**

**5AS4A**

Glass octal type used in power supply of television receivers having high dc requirements. Outline 19D, **Outlines** section. This type may be supplied with pins 3, 5, and 7 omitted. Tube requires octal socket. Vertical mounting

is preferred, but horizontal mounting is permissible if pins 1 and 4 are in vertical plane. It is especially important that this tube, like other power-handling tubes, be adequately ventilated. Heater volts (ac), 5.0; amperes, 3.0. For maximum ratings, typical operation, and curves, refer to type 5U4GB.

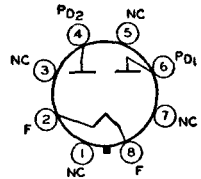

**5T**

**MEDIUM-MU TRIODE—  
SHARP-CUTOFF PENTODE**

**5AV8**

Miniature type used in a wide variety of applications in television receivers employing series-connected heater strings. Outline 6B, **Outlines** section. Tube requires miniature nine-contact socket and may be mounted in any position.

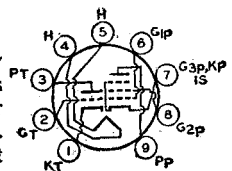

**9DZ**

Heater Voltage (ac/dc) .....	4.7	volts
Heater Current .....	0.6	ampere
Heater Warm-Up Time (Average) .....	11	seconds
Peak Heater-Cathode Voltage:		
Heater negative with respect to cathode .....	200 max	volts
Heater positive with respect to cathode .....	200 <sup>o</sup> max	volts
Direct Interelectrode Capacitances:		
Triode Unit:		
Grid to Plate .....	1.5	pF
Grid to Cathode and Heater .....	2	pF
Plate to Cathode and Heater .....	0.34	pF
Pentode Unit:		
Grid No.1 to Plate .....	0.04 max	pF
Grid No.1 to Cathode, Heater, Grid No.2, Grid No.3, and Internal Shield .....	7	pF
Plate to Cathode, Heater, Grid No.2, Grid No.3, and Internal Shield .....	3	pF
Triode Grid to Pentode Plate .....	0.005	pF
Pentode Grid No.1 to Triode Plate .....	0.006	pF
Pentode Plate to Triode Plate .....	0.045	pF

<sup>o</sup> The dc component must not exceed 100 volts.

### Class A<sub>1</sub> Amplifier

#### MAXIMUM RATINGS (Design-Center Values):

	Triode Unit	Pentode Unit	
Plate Voltage .....	300 max	300 max	volts
Grid No.2 Supply Voltage .....	—	300 max	volts
Grid-No.2 (Screen-Grid) Voltage .....	—	See curve page 80	
Grid-No.1 (Control-Grid) Voltage, Positive-bias value ..	0 max	0 max	volts
Plate Dissipation .....	2.5 max	2 max	watts
Grid-No.2 Input:			
For grid-No.2 voltages up to 150 volts .....	—	0.5 max	watt
For grid-No.2 voltages between 150 and 300 volts ..	—	See curve page 80	

#### CHARACTERISTICS:

Plate Supply Voltage .....	200	200	volts
Grid-No.2 Supply Voltage .....	—	150	volts
Grid-No.1 Voltage .....	—6	—	volts
Cathode-Bias Resistor .....	—	180	ohms
Amplification Factor .....	19	—	ohms
Plate Resistance (Approx.) .....	5750	300000	ohms
Transconductance .....	3300	6200	μmhos
Grid-No.1 Voltage (Approx.) for plate current of 10 μA ..	—19	—8	volts
Plate Current .....	13	9.5	mA
Grid-No.2 Current .....	—	2.8	mA
Grid-No.1-Circuit Resistance*:			
For fixed-bias operation .....	0.5 max	0.25 max	megohm
For cathode-bias operation .....	1.0 max	1.0 max	megohm

\* If either unit is operating at maximum rated conditions, grid-No.1-circuit resistance for both units should not exceed the stated values.

### MEDIUM-MU TRIODE— SHARP-CUTOFF PENTODE

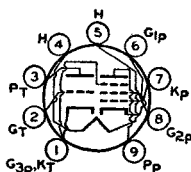

9EC

Miniature type used as combined vhf oscillator and mixer in television receivers employing series-connected heater strings. Outline 6B, **Outlines** section. Tube requires miniature nine-contact socket and may be mounted

**5B8**

in any position. Heater volts (ac/dc), 4.7; amperes, 0.6; warm-up time (average) 11 seconds; peak heater-cathode volts, 200 (the dc component must not exceed 100 volts when the heater is positive with respect to the cathode).

Class A<sub>1</sub> Amplifier

## MAXIMUM RATINGS (Design-Center Values):

	Triode Unit	Pentode Unit	
Plate Voltage	300 max	300 max	volts
Grid No.2 (Screen-Grid) Supply Voltage	—	300 max	volts
Grid-No.2 Voltage	—	See curve page 80	
Grid-No.1 (Control-Grid) Voltage, Positive-bias value	0 max	0 max	volts
Plate Dissipation	2.5 max	2 max	watts
Grid No.2 Input:			
For grid-No.2 voltages up to 150 volts	—	0.5 max	watt
For grid-No.2 voltages between 150 and 300 volts	—	See curve page 80	

## CHARACTERISTICS:

Plate Supply Voltage	200	200	volts
Grid-No.2 Supply Voltage	—	150	volts
Grid Voltage	-6	—	volts
Cathode-Bias Resistor	—	180	ohms
Amplification Factor	19	—	
Plate Resistance (Approx.)	5750	30000	ohms
Transconductance	3300	6200	μmhos
Plate Current	13	9.5	mA
Grid-No.2 Current	—	2.8	mA
Grid-No.1 Voltage (Approx.) for plate current of 10 μA	-19	-8	volts

## MAXIMUM CIRCUIT VALUES:

Grid-No.1-Circuit Resistance*:			
For fixed-bias operation	0.5 max	0.25 max	megohm
For cathode-bias operation	1.0 max	1.0 max	megohm

\* If either unit is operated at maximum rated conditions, grid-No.1-circuit resistance for both units should not exceed the stated values.

## FULL-WAVE VACUUM RECTIFIER

**5BC3**  
**5BC3A**

Novar types used in power supplies of radio equipment and television receivers having high dc requirements. Outlines 17C and 31C, respectively, Outlines section. Tubes require novar nine-contact socket. Vertical operation

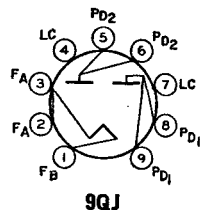

is preferred, but tubes may be operated in horizontal position if pins 2 and 7 are in vertical plane. It is especially important that these tubes, like other power-handling tubes, be adequately ventilated. Filament volts (ac), 5; amperes, 3.

## Full-Wave Rectifier

## MAXIMUM RATINGS (Design-Maximum Values):

Peak Inverse Plate Voltage		1700 max	volts
Peak Plate Current (Per Plate)		1 max	ampere
Hot-Switching Transient Plate Current (Per Plate)*		5 max	amperes
AC Plate-Supply Voltage (Per Plate, rms)		See Rating Chart	
DC Output Current (Per Plate)		See Rating Chart	

## TYPICAL OPERATION WITH CAPACITOR

## INPUT TO FILTER:

AC Plate-to-Plate Supply Voltage (rms)	600	900	1100	volts
Filter-Input Capacitor*	40	40	40	μF
Total Effective Plate-Supply Impedance per Plate	21	67	97	ohms
DC Output Voltage at Input to Filter (Approx.):				
At load current of: 300 mA	290	—	—	volts
275 mA	—	460	—	volts
162 mA	—	—	630	volts
150 mA	335	—	—	volts
137.5 mA	—	520	—	volts
81 mA	—	—	680	volts

**TYPICAL OPERATION WITH CHOKE INPUT TO FILTER:**

AC Plate-to-Plate Supply Voltage (rms) .....	900	1100	volts
Filter-Input Choke .....	10	10	henries
DC Output Voltage at Input to Filter (Approx.):			
At load current of: 348 mA .....	340	—	volts
275 mA .....	—	440	volts
174 mA .....	355	—	volts
137.5 mA .....	—	455	volts

\* If hot switching is regularly required in operation, the use of choke-input circuits is recommended. Such circuits limit the hot-switching current to a value no higher than that of the peak plate current. When capacitor-input circuits are used, a maximum peak current value per plate of 5 amperes during the initial cycles of the hot-switching transient should not be exceeded.

▪ Higher values of capacitance than indicated may be used, but the effective plate-supply impedance may have to be increased to prevent exceeding the maximum rating for peak plate current.

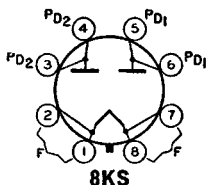
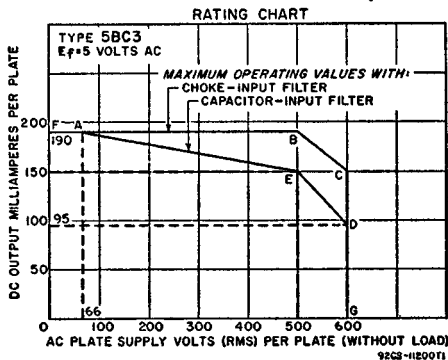

**FULL-WAVE VACUUM RECTIFIER**

Glass octal type used in power supply of radio and television receivers having high dc requirements. Outline 19E, **Outlines** section. Tube requires octal socket; operation in vertical position is preferred, but horizontal operation is permissible if pins 2 and 4 are in vertical plane. It is especially important that this tube, like other power-handling tubes, be adequately ventilated. Filament volts (ac/dc), 5; amperes, 3.

**5DJ4**

**Full-Wave Rectifier**

**MAXIMUM RATINGS (Design-Maximum Values):**

Peak Inverse Plate Voltage .....	1700 max	volts
Peak Plate Current (Per Plate) .....	1 max	ampere
Hot-Switching Transient Plate Current (Per Plate) .....	5 max	amperes
AC Plate-Supply Voltage (Per Plate, rms, without load) .....	See Rating Chart	
DC Output Current (Per Plate) .....	See Rating Chart	

**TYPICAL OPERATION:**

Filter Input	Capacitor		Choke	
AC Plate-to-Plate Supply Voltage (rms, without load) .....	600	900	1100	volts
Filter-Input Capacitor <sup>a</sup> .....	40	40	—	μF
Filter-Input Choke .....	—	—	10	henries



### MEDIUM-MU TRIODE— SHARP-CUTOFF PENTODE

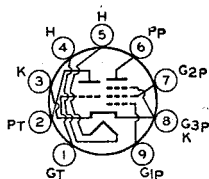

**9G5**

Miniature type used as combined vhf oscillator and mixer in television receivers employing series-connected heater strings. Outline 6B, **Outlines** Section. Tube requires miniature nine-contact socket and may be mounted

**5LJ8**

in any position.

Heater Voltage (ac/dc)	5.6	volts
Heater Current	0.45	ampere
Heater Warm-up Time (Average)	11	seconds
Peak Heater-Cathode Voltage:		
Heater negative with respect to cathode	200 max	volts
Heater positive with respect to cathode	200*max	volts
Direct Interelectrode Capacitance: <sup>a</sup>		
Triode Unit:		
Grid to Plate	1.4	pF
Grid to Cathode, Heater, Pentode Grid No.3, and Internal Shield	2.4	pF
Plate to Cathode, Heater, Pentode Grid No.3, and Internal Shield	2.0	pF
Pentode Unit:		
Grid No.1 to Plate	0.015 max	pF
Grid No.1 to Cathode, Heater, Grid No.2, Grid No.3, and Internal Shield	5.5	pF
Plate to Cathode, Heater, Grid No.2, Grid No.3, and Internal Shield	3.4	pF

\* The dc component must not exceed 100 volts.

<sup>a</sup> With external shield connected to cathode.

### Class A<sub>1</sub> Amplifier

MAXIMUM RATINGS (Design-Maximum Values):	Triode Unit	Pentode Unit	
Plate Voltage	280 max	280 max	volts
Grid-No.2 (Screen-Grid) Supply Voltage	—	280 max	volts
Grid-No.2 Voltage		See curve page 80	
Grid-No.1 (Control-Grid) Voltage, Positive-bias Value	0 max	0 max	volts
Plate Dissipation	2 max	2 max	watts
Grid-No.2 Input	—	0.5 max	watt
Cathode Current	20 max	20 max	mA

#### CHARACTERISTICS:

Plate Supply Voltage	125	125	volts
Grid-No.2 Supply Voltage	—	125	volts
Grid-No.1 Voltage	0	0	volts
Cathode-Bias Resistor	68	33	ohms
Amplification Factor	40	—	
Plate Resistance (Approx.)	5000	125000	ohms
Transconductance	8000	13000	μmhos
Plate Current	13	12	mA
Grid-No.2 Current	—	3.5	mA
Grid-No.1 Voltage (Approx.) for plate current of 30 μA	—6.5	—4	volts

#### MAXIMUM CIRCUIT VALUES:

Grid-No. 1-Circuit Resistance:			
For fixed-bias operation	1.0 max	0.5 max	megohm
For cathode-bias operation	0.5 max	0.25 max	megohm

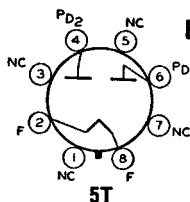

**5T**

### FULL-WAVE VACUUM RECTIFIER

Glass octal type used in power supplies of radio and television receivers having high dc requirements. Outline 19E, **Outlines** section. Tube requires octal socket. This type may be supplied with pins 3, 5, and 7 omitted.

**5U4GB**

Vertical mounting is preferred but horizontal mounting is permissible if pins 1 and 4 are in vertical plane. The coated filament is designed to operate from the ac line through a step-down transformer. The voltage at the filament terminals should be 5.0 volts at an average line voltage of 117 volts. It is especially important that this tube, like other power-handling tubes, be adequately ventilated. For discussion of Rating Chart and Operation Characteristics, refer to **Interpretation of Tube Data**. Filament volts (ac), 5; amperes, 3.

**Full-Wave Rectifier**

**MAXIMUM RATINGS (Design-Center Values):**

Peak Inverse Plate Voltage .....	1550 max	volts
Peak Plate Current (Per Plate) .....	1.0 max	ampere
Hot-Switching Transient Plate Current (Per Plate) .....	#	
AC Plate Supply Voltage (Per Plate, rms) .....	See Rating Chart	
DC Output Current (Per Plate) .....	See Rating Chart	

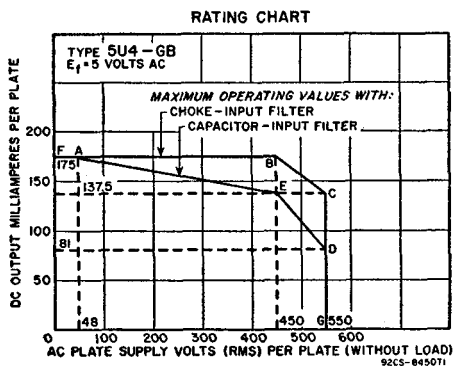

**TYPICAL OPERATION WITH CAPACITOR**

**INPUT TO FILTER:**

AC Plate-to-Plate Supply Voltage (rms) .....	600	900	1100	volts
Filter-Input Capacitor* .....	40	40	40	$\mu$ F
Total Effective Plate-Supply Impedance per Plate .....	21	67	97	ohms
DC Output Voltage at Input to Filter (Approx.):				
At half-load current of	{			
150 mA .....	335	—	—	volts
137.5 mA .....	—	520	—	volts
81 mA .....	—	—	680	volts
At full-load current of	{			
300 mA .....	290	—	—	volts
275 mA .....	—	460	—	volts
162 mA .....	—	—	630	volts
Voltage Regulation (Approx.):				
Half-load to full-load current .....	45	60	50	volts

**TYPICAL OPERATION WITH CHOKE INPUT TO FILTER:**

AC Plate-to-Plate Supply Voltage (rms) .....	900	1100	volts
Filter-Input Choke .....	10	10	henries
DC Output Voltage at Input to Filter (Approx.):			
At half-load current of	{		
174 mA .....	355	—	volts
137.5 mA .....	—	455	volts

# If hot switching is regularly required in operation, the use of choke-input circuits is recommended. Such circuits limit the hot-switching current to a value no higher than that of the peak plate current. When capacitor-input circuits are used, a maximum peak current value per plate of 4.6 amperes during the initial cycles of the hot-switching transient should not be exceeded.

\* Higher values of capacitance than indicated may be used, but the effective plate-supply impedance may have to be increased to prevent exceeding the maximum rating for peak plate current.



At full-load current of	{ 348 mA .....	340	—	volts
	{ 275 mA .....	—	440	volts
Voltage Regulation (Approx.):				
Half-load to full-load current .....		15	15	volts

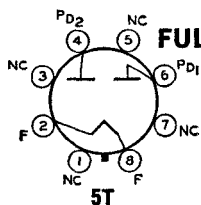
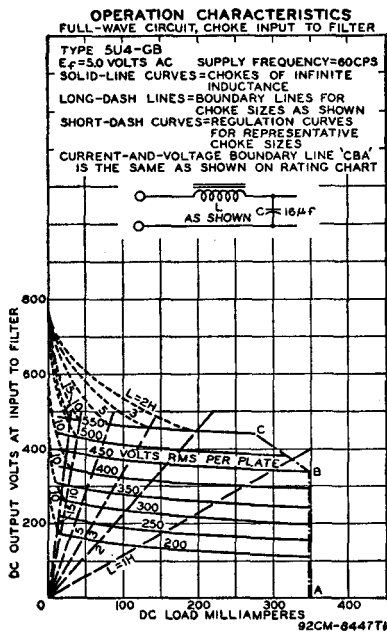
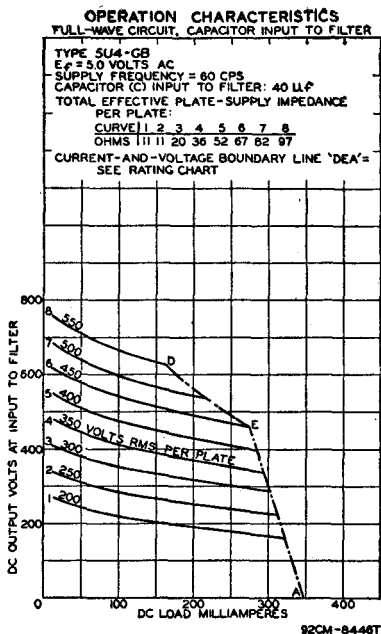

**FULL-WAVE VACUUM RECTIFIER**

Glass octal type used as power supply in color television receivers and other equipment having high dc requirements. Outline 19E, Outlines section. Tube requires octal socket. Vertical mounting is preferred, but horizontal

**5V3A**

mounting is permissible if pins 2 and 4 are in vertical plane. It is especially important that this tube, like other power-handling tubes, be adequately ventilated. For discussion of Rating Chart, refer to Interpretation of Tube Data. Filament volts (ac/dc), 5; amperes, 3.

**Full-Wave Rectifier**

**MAXIMUM RATINGS** (Design-Maximum Values):

Peak Inverse Plate Voltage .....	1550 max	volts
Peak Plate Current (Per Plate) .....	1.4 max	amperes
Hot-Switching Transient Plate Current (Per Plate) .....	6.6 max	amperes
AC Plate-Supply Voltage (Per Plate, rms, without load) .....	550 max	volts
DC Output Current (Per Plate) .....	415 max	mA

\* With capacitor-input filter for ac plate-supply volts (rms, per plate, without load) = 470.

**TYPICAL OPERATION:**

Filter Input	Capacitor	Choke	
AC Plate-to-Plate Supply Voltage (rms) .....	850	1000	volts
Filter-Input Capacitor* .....	40	—	μF
Effective Plate-Supply Impedance per Plate .....	50	—	ohms
Minimum Filter-Input Choke .....	—	10	henries
DC Output Current .....	350	350	mA
DC Output at Input to Filter (Approx.) .....	440	390	volts

**CHARACTERISTICS:**

Tube Voltage Drop for plate current of 350 mA (per plate) ..... 42 volts

■ When capacitor values greater than 40 μF are used, the effective plate-supply impedance should be increased so that the maximum rating for peak plate current is not exceeded.

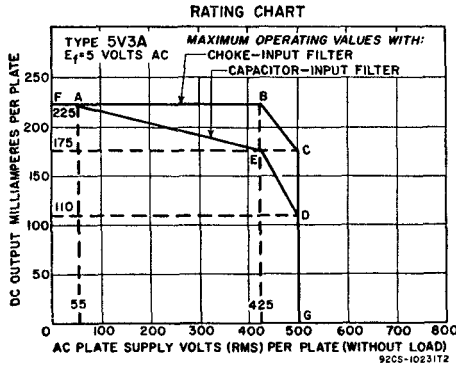

**FULL-WAVE VACUUM RECTIFIER**

**5V4G**  
**5V4GA**

Glass octal types used in full-wave power supplies having high dc requirements. Outlines 25 and 19B, respectively, **Outlines** section. Tubes require octal socket and may be mounted in any position. The heater is designed

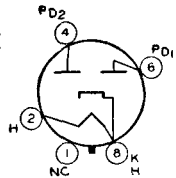

**5L**

to operate from the ac line through a step-down transformer. The voltage at the heater terminals should be 5.0 volts under operating conditions at an average line voltage of 117 volts. It is especially important that these tubes, like other power-handling tubes, be adequately ventilated. Heater volts (ac/dc), 5; amperes, 2.

**Full-Wave Rectifier**

**MAXIMUM RATINGS (Design-Center Values):**

Peak Inverse Plate Voltage .....	1400 max	volts
AC Plate-Supply Voltage (Per Plate, rms):		
With capacitor-input filter .....	375 max	volts
With choke-input filter .....	500 max	volts
Peak Plate Current (Per Plate) .....	525 max	mA
DC Output Current .....	175 max	mA

**TYPICAL OPERATION:**

Filter Input	Capacitor	Choke	
AC Plate-to-Plate Supply Voltage (rms) .....	750	1000	volts
Filter-Input Capacitor* .....	10	—	μF
Total Effective Plate-Supply Impedance per Plate .....	100	—	ohms
Filter-Input Choke .....	—	4	henries
DC Output Voltage at Input to Filter (Approx.) for dc output current of 175 mA .....	410	410	volts

\* Higher values of capacitance than indicated may be used, but the effective plate-supply impedance may have to be increased to prevent exceeding the maximum rating for peak plate current.

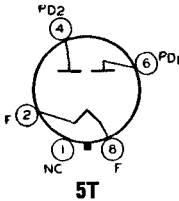
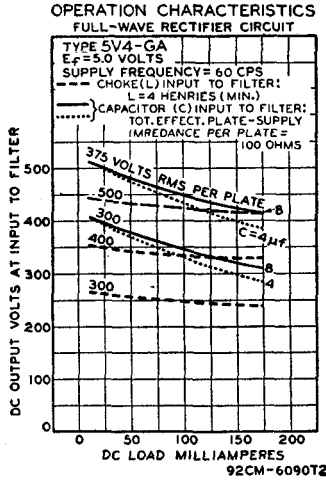

### FULL-WAVE VACUUM RECTIFIER

Glass octal type used in power supply of radio equipment having moderate dc requirements. Outline 13E, **Outlines** section. Tube requires octal socket. Vertical mounting is preferred, but horizontal mounting is permissible if pins 2 and 8 are in horizontal plane. It is especially important that this tube, like other power-handling tubes, be adequately ventilated. For discussion of Rating Chart and Operating Characteristics, refer to **Interpretation of Tube Data**. Filament volts (ac), 5; amperes, 2.

**5Y3GT**

5T

### Full-Wave Rectifier

MAXIMUM RATINGS (Design-Center Values):

Peak Inverse Plate Voltage .....	1400 max	volts
Peak Plate Current (Per Plate) .....	440 max	mA

1400 max volts  
440 max mA

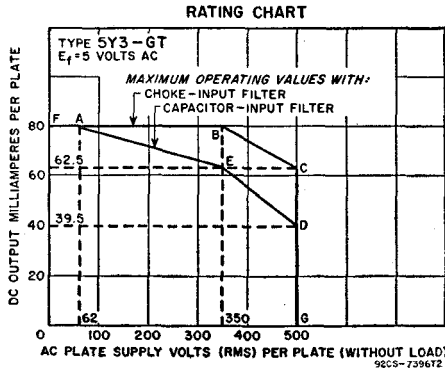

Hot-Switching Transient Plate Current (Per Plate) .....	2.5 max amperes
AC Plate Supply Voltage (Per Plate, rms) .....	See Rating Chart
DC Output Current (Per Plate) .....	See Rating Chart

**TYPICAL OPERATION WITH CAPACITOR  
INPUT TO FILTER:**

AC Plate-to-Plate Supply Voltage (rms) .....	700	1000	volts	
Filter Input Capacitor* .....	20	10	$\mu$ F	
Effective Plate-Supply Impedance per Plate .....	50	140	ohms	
DC Output Voltage at Input to Filter (Approx.):				
At half-load current of {	62.5 mA .....	390	—	volts
	42 mA .....	—	610	volts
At full-load current of {	125 mA .....	360	—	volts
	84 mA .....	—	560	volts
Voltage Regulation (Approx.):				
Half-load to full-load current .....	40	50	volts	

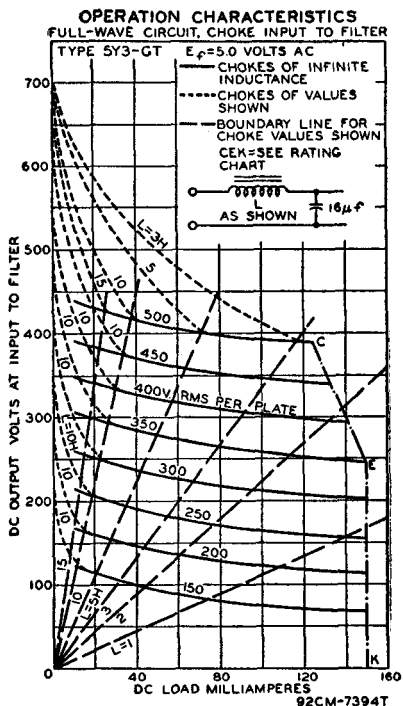
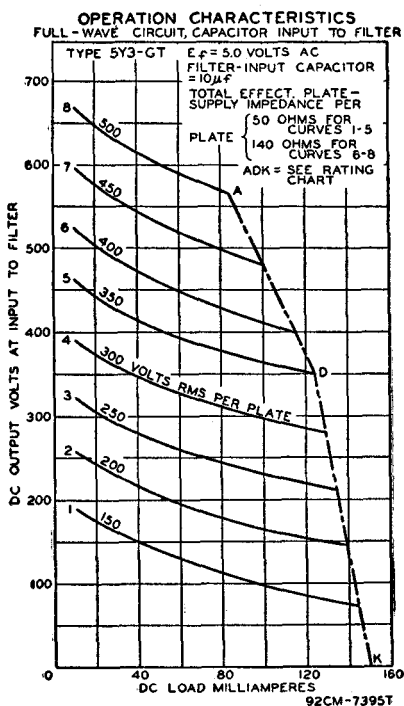

**TYPICAL OPERATION WITH CHOKE  
INPUT TO FILTER:**

AC Plate-to-Plate Supply Voltage (rms) .....	700	1000	volts	
Filter Input Choke# .....	10	10	henries	
DC Output Voltage at Input to Filter (Approx.):				
At half-load current of {	75 mA .....	270	—	volts
	62.5 mA .....	—	405	volts
At full-load current of {	150 mA .....	245	—	volts
	125 mA .....	—	380	volts
Voltage Regulation (Approx.):				
Half-load to full-load current .....	25	15	volts	

\* Higher values of capacitance than indicated may be used but the effective plate supply impedance may have to be increased to prevent exceeding the maximum rating for hot-switching transient plate current.

# This value is adequate to maintain optimum regulation in the region to the right of line L = 10H on curve OPERATION CHARACTERISTICS with Choke Input to Filter, provided the load currents are not less than 35 mA, and 50 mA, respectively, for Plate-to-Plate supply voltages of 700 and 1000 volts (rms).

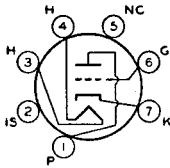

5CE

**HIGH-MU TRIODE**

Miniature type used as cathode-drive amplifier, frequency converter, or oscillator at frequencies up to about 300 megacycles per second, particularly in television and FM receivers.

**6AB4**

Outline 5C, **Outlines** section. Tube requires miniature seven-contact socket and may be mounted in any position. Heater volts (ac/dc), 6.3; amperes, 0.15. For maximum ratings, characteristics, and curves, refer to type 12AT7.

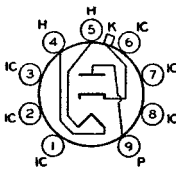

9CB

**HALF-WAVE VACUUM RECTIFIER**

Miniature type used as a damper tube in horizontal deflection circuits of television receivers. Outline 7C, **Outlines** section. Tube requires miniature nine-contact socket and may be mounted in any position. Socket terminals 1, 2, 3, 6, 7, and 8 should not be used as tie points.

**6AF3**

Related types:  
12AF3

It is especially important that this tube, like other power-handling tubes, be adequately ventilated. Type 12AF3 is identical with type 6AF3 except for heater ratings, as shown below.

	6AF3	12AF3	
Heater Voltage (ac/dc) .....	6.3	12.6	volts
Heater Current .....	1.2	0.6	amperes
Heater Warm-up Time (Average) .....	—	11	seconds

**Damper Service**

For operation in a 525-line, 30-frame system

**MAXIMUM RATINGS (Design-Maximum Values):**

Peak Inverse Plate Voltage† .....	4500 max	volts
Peak Plate Current .....	750 max	mA
Average Plate Current .....	185 max	mA
Bulb Temperature (At hottest point) .....	210 max	°C
Peak Heater-Cathode Voltage:		
Heater negative with respect to cathode .....	4500*max	volts
Heater positive with respect to cathode .....	300*max	volts

† The duration of the voltage pulse must not exceed 15 per cent of one horizontal scanning cycle. In a 525-line, 30-frame system, 15 per cent of one horizontal scanning cycle is 10 microseconds.

\* The dc component must not exceed 1000 volts.

▲ The dc component must not exceed 100 volts.

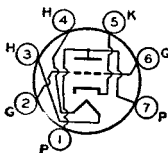

7DK

**MEDIUM-MU TRIODE**

Miniature types used as local oscillators in uhf television receivers covering the frequency range of 470 to 890 megacycles per second. Outlines 5C and 5B, respectively, **Outlines** section. Tubes require miniature seven-

**6AF4**  
**6AF4A**

Related types:  
2AF4B, 3AF4A

contact socket and may be mounted in any position. Types 2AF4B and 3AF4A are identical with type 6AF4A except for heater and heater-cathode ratings, as shown below.

	2AF4B	3AF4A	6AF4 6AF4A	
Heater Voltage (ac/dc) .....	2.35	3.15	6.3	volts
Heater Current .....	0.6	0.45	0.225	ampere
Heater Warm-up Time (Average) .....	11	11	—	seconds
Peak Heater-Cathode Voltage:				
Heater negative with respect to cathode ..	180	50	50 max	volts
Heater positive with respect to cathode ..	180*	50 $\Delta$	50 $\Delta$ max	volts
Direct Interelectrode Capacitances:*				
Grid to Plate .....			1.9	pF
Grid to Cathode and Heater .....			2.2	pF
Plate to Cathode and Heater .....			1.4	pF
Heater to Cathode* .....			2.2	pF

\* The dc component must not exceed 100 volts.

$\Delta$  The dc component must not exceed 25 volts.

• With external shield connected to cathode, except as noted.

\* With external shield connected to plate.

### Class A<sub>1</sub> Amplifier

#### CHARACTERISTICS:

Plate Supply Voltage .....	80	volts
Cathode-Bias Resistor .....	150	ohms
Amplification Factor .....	13.5	
Plate Resistance (Approx.) .....	2100	ohms
Transconductance .....	6500	$\mu$ mhos
Plate Current .....	17.5	mA

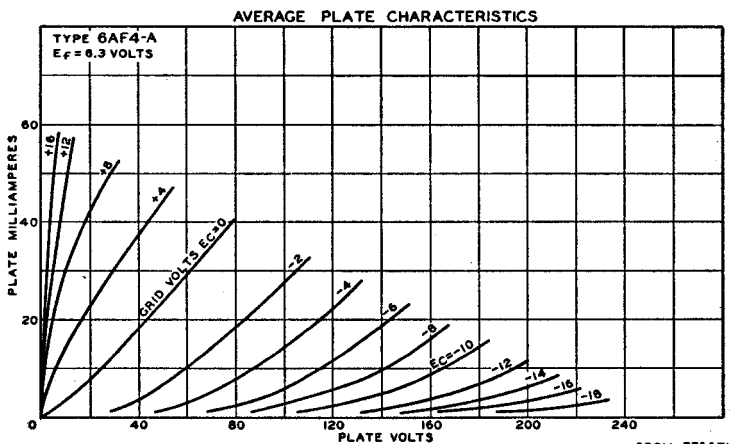

### UHF Oscillator

#### MAXIMUM RATINGS (Design-Maximum Values):

Plate Voltage .....	150 max	volts
Grid Voltage, Negative-bias value .....	-50 max	volts
Grid Current .....	2 max	mA
Plate Dissipation .....	2.5 max	watts
DC Cathode Current .....	24 max	mA

#### TYPICAL OPERATION AS OSCILLATOR AT 1000 Mc/s:

Plate Supply Voltage .....	100	volts
Plate Resistor .....	220	ohms
Grid Resistor .....	10000	ohms
Plate Current .....	17	mA
Grid Current (Approx.) .....	750	$\mu$ A

**MAXIMUM CIRCUIT VALUES:**

Grid-Circuit Resistance:  
 For fixed-bias operation .....  
 For cathode-bias operation .....

Not recommended  
 0.5 max megohm

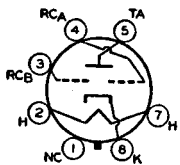

**7AG**

**ELECTRON-RAY TUBE**

Glass octal type used to indicate visually, by means of two shadows on the fluorescent target, the effects of changes in the controlling voltages. It is a twin-indicator type and is used as a convenient means of indicating

**6AF6G**

accurate radio-receiver tuning. This type may be supplied with pin No.1 omitted. Tube requires octal socket. Heater volts (ac/dc), 6.3; amperes, 0.15. Maximum ratings in indicator service; fluorescent-target volts, 250 max, 125 min; ray-control-electrode supply volts, 250 max; peak heater-cathode volts, 90 max. Typical operation: fluorescent-target volts, 250; fluorescent-target mA, 3.75; ray-contact-electrode volts (approx. for 0° shadow angle), 155; ray-control-electrode volts (approx. for 100° shadow angle), 0.

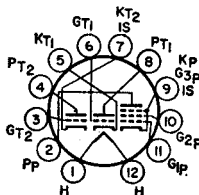

**12DP**

**DUAL TRIODE—  
SHARP-CUTOFF PENTODE**

Duodecatriode type used in a variety of applications in television receivers. The high-mu triode unit is used for agc keyer service, the medium-mu triode unit for sync separator service, and the pentode unit for video amplifier service. Outline 8C, **Outlines** section. Tube requires duodecatriode twelve-contact socket and may be mounted in any position. Type 15AF11 is identical with type 6AF11 except for heater ratings, as shown below.

**6AF11**

Related type:  
**15AF11**

amplifier service. Outline 8C, **Outlines** section. Tube requires duodecatriode twelve-contact socket and may be mounted in any position. Type 15AF11 is identical with type 6AF11 except for heater ratings, as shown below.

	<b>6AF11</b>	<b>15AF11</b>	
Heater Voltage (ac/dc) .....	6.3	14.7	volts
Heater Current .....	1.05	0.45	amperes
Heater Warm-up Time (Average) .....	—	11	seconds
Peak Heater-Cathode Voltage:			
Heater negative with respect to cathode .....	200 max	200 max	volts
Heater positive with respect to cathode .....	200*max	200*max	volts

• The dc component must not exceed 100 volts.

**Class A<sub>1</sub> Amplifier**

**MAXIMUM RATINGS**

(Design-Maximum Values):

	Triode Unit No. 1	Triode Unit No. 2	Pentode Unit	
Plate Voltage .....	—	—	330 max	volts
Grid-No.2 (Screen-Grid) Supply Voltage .....	330 max	330 max	330 max	volts
Grid-No.2 Voltage .....			See curve page 80	
Grid-No.1 (Control-Grid) Voltage, Positive-bias value .....	0 max	0 max	0 max	volts
Plate Dissipation .....	1.1 max	2 max	5 max	watts
Grid-No.2 Input:				
For grid-No.2 voltages up to 165 volts ...	—	—	1.25 max	watts
For grid-No.2 voltages between 165 and 330 volts .....			See curve page 80	

**CHARACTERISTICS:**

Plate Supply Voltage .....	200	200	250	volts
Grid-No.2 Supply Voltage .....	—	—	150	volts
Grid-No.1 Voltage .....	—2	—	—	volts
Cathode-Bias Resistor .....	—	220	100	ohms
Amplification Factor .....	68	41	—	
Plate Resistance (Approx.) .....	12400	9400	68000	ohms

Transconductance .....	5500	4400	11000	$\mu$ mhos
Plate Current .....	7	9.2	24	mA
Grid-No.2 Current .....	—	—	4.8	mA
Grid-No.1 Voltage (Approx.) for plate current of 100 $\mu$ A .....	—	-6.5	-10	volts

MAXIMUM CIRCUIT VALUES:	Triode Unit No.1	Triode Unit No.2	Pentode Unit	
Grid-No.1-Circuit Resistance:				
For fixed-bias operation .....	0.5 max	0.5 max	0.25 max	megohm
For cathode-bias operation .....	1 max	1 max	1 max	megohm

## SHARP-CUTOFF PENTODE

# 6AG5

Miniature type used in compact radio equipment as an rf or if amplifier up to 400 megacycles per second. Outline 5C, **Outlines** section. Tube requires miniature seven-contact socket and may be mounted in any position.



### 7BD

Heater volts (ac/dc), 6.3; amperes, 0.3. For typical operation as a resistance-coupled amplifier, refer to **Resistance-Coupled Amplifier** section.

### Class A<sub>1</sub> Amplifier

#### MAXIMUM RATINGS (Design-Center Values):

	Triode Connection*	Pentode Connection	
Plate Voltage .....	300 max	300 max	volts
Grid-No.2 (Screen-Grid) Supply Voltage .....	—	300 max	volts
Grid-No.2 Voltage .....	—	See curve page 80	
Grid-No.1 (Control-Grid) Voltage, Positive-bias value .....	0 max	0 max	volts
Plate Dissipation .....	2.5 max	2 max	watts
Grid-No.2 Input:			
For grid-No.2 voltages up to 150 volts .....	—	0.5 max	watt
For grid-No.2 voltages between 150 and 300 volts .....	—	See curve page 80	

#### CHARACTERISTICS:

	Triode Connection*		Pentode Connection			
Plate Supply Voltage .....	180	250	100	125	250	volts
Grid-No.2 Supply Voltage .....	—	—	100	125	150	volts
Cathode-Bias Resistor .....	330	820	180	100	180	ohms
Amplification Factor .....	45	42	—	—	—	
Plate Resistance (Approx.) .....	0.008	0.01	0.6	0.5	0.8	megohm
Transconductance .....	5700	3800	4500	5100	5000	$\mu$ mhos
Grid-No.1 Voltage (Approx.) for plate current of 10 $\mu$ A .....	—	—	-5	-6	-8	volts
Plate Current .....	7	5.5	4.5	7.2	6.5	mA
Grid-No.2 Current .....	—	—	1.4	2.1	2.0	mA

\* Grid No.2 connected to plate.

## POWER PENTODE

# 6AG7

Metal type used in output stage of video amplifier of television receivers. Outline 2B, **Outlines** section. Tube requires octal socket. Heater volts (ac/dc), 6.3; amperes, 0.65. Typical operation as class A<sub>1</sub> amplifier: plate

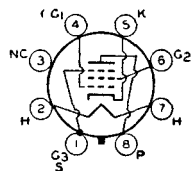

### 8Y

volts, 300 max; grid No.3 connected to cathode at socket; grid-No.2 volts, 150 (300 max); grid-No.1 volts, -3 (0 max); peak af grid-No.1 volts, 3; plate mA, 30 (zero signal), 30.5 (maximum signal); grid-No.2 mA, 7 (zero signal); 9 (maximum signal); plate resistance (approx.), 0.13 megohm; transconductance, 11000  $\mu$ mhos; load resistance, 10000 ohms; maximum-signal power output, 3 watts; plate dissipation, 9 max watts; grid-No.2 input, 1.5 max watts.



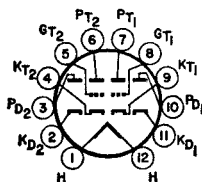

12DA

**TWIN DIODE—TWIN TRIODE**

Duodecar type containing two diodes and two high- $\mu$  triodes, used primarily in FM stereo multiplex service. Outline 8A, **Outlines** section. Tube requires duodecar twelve-contact socket and may be mounted in any

**6AG11**

position. Heater volts (ac/dc), 6.3; amperes, 0.75; peak heater-cathode volts, 200 (the dc component must not exceed 100 volts when the heater is positive with respect to the cathode).

**Class A<sub>1</sub> Amplifier (Each Triode Unit)**

**MAXIMUM RATINGS (Design-Maximum Values):**

Plate Voltage .....	330 max	volts
Plate Dissipation .....	2 max	watts

**CHARACTERISTICS:**

Plate Voltage .....	125	volts
Grid Voltage .....	-1	volt
Amplification Factor .....	66	
Plate Resistance (Approx.) .....	8500	ohms
Transconductance .....	7800	$\mu$ mhos
Plate Current .....	7.5	mA
Grid Voltage (Approx.), for plate current of 30 $\mu$ A .....	-5	volts

**Diode Units (Each Unit)**

**MAXIMUM RATINGS (Design-Maximum Values):**

Plate Current .....	5 max	mA
<b>CHARACTERISTICS, Instantaneous Value:</b>		
Tube Voltage Drop for plate current of 18 mA .....	5	volts

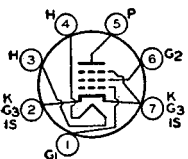

7BD

**SHARP-CUTOFF PENTODE**

Miniature types used as rf or if amplifiers especially in high-frequency wide-band applications. They are useful as amplifiers at frequencies up to 400 megacycles per second. Outline 5B, **Outlines** section. Tubes require

**6AK5**  
**6AK5/**  
**EF95**

miniature seven-contact socket and may be mounted in any position.

Heater Voltage (ac/dc) .....	6.3	volts
Heater Current .....	0.175	ampere
<b>Peak Heater-Cathode Voltage:</b>		
Heater negative with respect to cathode .....	90 max	volts
Heater positive with respect to cathode .....	90 max	volts
<b>Direct Interelectrode Capacitances (Approx.):*</b>		
Grid No.1 to Plate .....	0.02 max	pF
Grid No.1 to Cathode, Heater, Grid No.2, Grid No.3, and Internal Shield .....	4.0	pF
Plate to Cathode, Heater, Grid No.2, Grid No.3, and Internal Shield .....	2.8	pF

\* With external shield connected to pins 2 or 7.

**Class A<sub>1</sub> Amplifier**

**MAXIMUM RATINGS (Design-Center Values):**

Plate Voltage .....	180 max	volts
Grid-No.2 (Screen-Grid) Voltage .....	See curve page 80	
Grid-No.2 Supply Voltage .....	180 max	volts

Grid-No.1 Voltage, Positive-bias value .....	0 max	volts
Plate Dissipation .....	1.7 max	watts
Grid-No.2 Input:		
For grid-No.2 voltages up to 90 volts .....	0.5 max	watt
For grid-No.2 voltages between 90 and 180 volts .....	See curve page 80	
Cathode Current .....	18 max	mA

**CHARACTERISTICS:**

Plate Supply Voltage .....	120	180	volts
Grid-No.2 Supply Voltage .....	120	120	volts
Cathode-Bias Resistor .....	180	180	ohms
Plate Resistance (Approx.) .....	0.3	0.5	megohm
Transconductance .....	5000	5100	μmhos
Grid-No.1 Voltage for plate current of 10 μA .....	-8.5	-8.5	volts
Plate Current .....	7.5	7.7	mA
Grid-No.2 Current .....	2.5	2.4	mA

**HALF-WAVE VACUUM RECTIFIER**

**6AL3**

Miniature type used as damper tube in horizontal-deflection circuits of television receivers. Outline 7D, **Outlines** section. Tube requires miniature nine-contact socket and may be mounted in any position. Socket terminals 1,

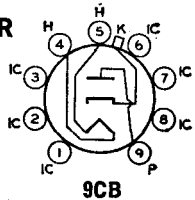

**9CB**

2, 3, 6, 7, and 8 should not be used as tie points. It is especially important that this tube, like other power-handling tubes, be adequately ventilated. Heater volts (ac/dc), 6.3; amperes, 1.55.

**Damper Service**

For operation in 525-line, 30-frame system

**MAXIMUM RATINGS (Design-Center Values):**

Peak Inverse Plate Voltage* (Absolute maximum) .....	7500 <sup>o</sup> max	volts
Peak Plate Current .....	550 max	mA
DC Plate Current .....	220 max	mA
Plate Dissipation .....	5 max	watts
Peak Heater-Cathode Voltage .....	6600 max	volts

<sup>o</sup> Under no circumstances should this absolute value be exceeded.

\* The duration of the voltage pulse must not exceed 15 per cent of one horizontal scanning cycle. In a 525-line, 30-frame system, 15 per cent of one horizontal scanning cycle is 10 microseconds.

**TWIN DIODE**

**6AL5**

**Related types:**  
3AL5, 12AL5

Miniature, high-perveance type used as detector in FM and television circuits. It is especially useful as a ratio detector in ac-operated FM receivers. Each diode section can be used independently of the other, or the two

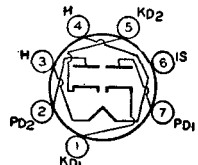

**6BT**

sections can be combined in parallel or full-wave arrangement. Resonant frequency of each unit is approximately 700 megacycles per second. Outline 5B, **Outlines** section. Tube requires miniature seven-contact socket and may be mounted in any position. Types 3AL5 and 12AL5 are identical with type 6AL5 except for heater ratings, as shown below.

Heater Voltage (ac/dc) .....	3AL5	6AL5	12AL5	
Heater Current .....	3.15	6.3	12.6	volts
Heater Warm-up Time (Average) .....	0.6	0.3	0.15	ampere
Peak Heater-Cathode Voltage:	11	—	—	seconds
Heater negative with respect to cathode ...	330 max	330 max	330 max	volts
Heater positive with respect to cathode ...	330 max	330 max	330 max	volts

AVERAGE CHARACTERISTICS  
HALF-WAVE RECTIFICATION—SINGLE DIODE

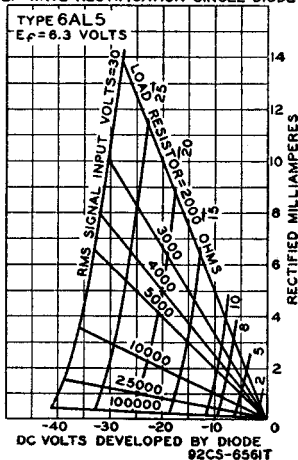

Direct Interelectrode Capacitances:

Plate No.1 to Cathode No.1, Heater, and Internal Shield .....	2.5	pF
Plate No.2 to Cathode No.2, Heater, and Internal Shield .....	2.5	pF
Cathode No.1 to Plate No.1, Heater, and Internal Shield .....	3.4	pF
Cathode No.2 to Plate No.2, Heater, and Internal Shield .....	3.4	pF
Plate No.1 to Plate No.2 .....	0.068 max	pF

Half-Wave Rectifier

MAXIMUM RATINGS (Design-Center Values):

Peak Inverse Plate Voltage .....	330 max	volts
Peak Plate Current (Per Plate) .....	54 max	mA
DC Output Current (Per Plate) .....	9 max	mA

TYPICAL OPERATION:

AC Plate Voltage per Plate (rms) .....	117	volts
Min. Total Effective Plate-Supply Impedance per Plate .....	300	ohms
DC Output Current per Plate .....	9	mA

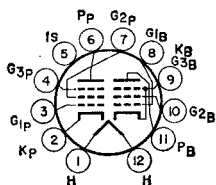

BEAM POWER TUBE—  
SHARP-CUTOFF PENTODE

Duodec type used as FM detector and audio-frequency output amplifier in television receivers. Outline 8B, Outlines section. Tube requires duodec twelve-contact socket and may be mounted in any position. Types

10AL11 and 12AL11 are identical with type 6AL11 except for heater ratings, as shown below.

	6AL11	10AL11	12AL11	
Heater Voltage (ac/dc) .....	6.3	9.8	12.6	volts
Heater Current .....	0.9	0.6	0.45	ampere
Heater Warm-up Time (Average) .....	—	11	11	seconds
Peak Heater-Cathode Voltage:				
Heater negative with respect to cathode ..	200 max	200 max	200 max	volts
Heater positive with respect to cathode ..	200=max	200=max	200=max	volts

■ The dc component must not exceed 100 volts.

6AL11

Related types:  
10AL11, 12AL11

Beam Power Unit as Class A<sub>1</sub> Amplifier

## MAXIMUM RATINGS (Design-Maximum Values):

Plate Voltage .....	275 max	volts
Grid-No.2 (Screen-Grid) Voltage .....	275 max	volts
Plate Dissipation .....	10 max	watts
Grid-No.2 Input .....	2 max	watts

## TYPICAL OPERATION:

Plate Voltage .....	250	volts
Grid-No.2 Voltage .....	250	volts
Grid-No.1 (Control-Grid) Voltage .....	-8	volts
Peak AF Grid-No.1 Voltage .....	8	volts
Zero-Signal Plate Current .....	35	mA
Maximum-Signal Plate Current .....	39	mA
Zero-Signal Grid-No.2 Current .....	2.5	mA
Maximum-Signal Grid-No.2 Current .....	7	mA
Plate Resistance (Approx.) .....	0.1	megohm
Transconductance .....	6500	$\mu$ hos
Load Resistance .....	5000	ohms
Total Harmonic Distortion .....	10	per cent
Maximum-Signal Power Output .....	4.2	watts

## MAXIMUM CIRCUIT VALUES:

## Grid-No.1-Circuit Resistance:

For fixed-bias operation .....	0.25 max	megohm
For cathode-bias operation .....	0.5 max	megohm

Pentode Unit as Class A<sub>1</sub> Amplifier

## CHARACTERISTICS:

Plate Supply Voltage .....	150	volts
Grid-No.3 (Suppressor-Grid) Voltage .....	0	volts
Grid-No.2 (Screen-Grid) Supply Voltage .....	100	volts
Cathode-Bias Resistor .....	560	ohms
Plate Resistance (Approx.) .....	0.15	megohm
Transconductance, Grid No.1 to Plate .....	1000	$\mu$ hos
Transconductance, Grid No.3 to Plate .....	400	$\mu$ hos
Plate Current .....	1.3	mA
Grid-No.2 Current .....	2.1	mA
Grid-No.1 Voltage (Approx.) for plate current of 30 $\mu$ A .....	-4.5	volts
Grid-No.3 Voltage (Approx.) for plate current of 30 $\mu$ A .....	-4.5	volts

## Pentode Unit as FM Detector

## MAXIMUM RATINGS (Design-Maximum Values):

Plate Voltage .....	330 max	volts
Grid-No.3 Voltage .....	28 max	volts
Grid-No.2 Supply Voltage .....	330 max	volts
Grid-No.2 Voltage .....	See curve page 80	
Grid-No.1 (Control-Grid) Voltage, Positive-bias value .....	0 max	volts
Plate Dissipation .....	1.7 max	watts
Grid-No.2 Input:		
For grid-No.2 voltages up to 165 volts .....	1.1 max	watts
For grid-No.2 voltages between 165 and 330 volts .....	See curve page 80	

DIODE—SHARP-CUTOFF  
PENTODE**6AM8A**Related type:  
5AM8

Miniature type used in diversified applications in television receivers employing series-connected heater strings. The pentode unit is used as an if amplifier, video amplifier, or agc amplifier. The high-perveance diode is

used as an audio detector, video detector, or dc restorer. Outline 6B, **Outlines** section. Tube requires miniature nine-contact socket and may be mounted in any position. Type 5AM8 is identical with type 6AM8A except for heater ratings, as shown below.

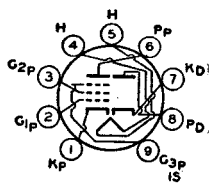
**9CY**

	5AM8	6AM8A	
Heater Voltage (ac/dc) .....	4.7	6.3	volts
Heater Current .....	0.6	0.45	ampere
Heater Warm-up Time (Average) .....	11	11	seconds
Peak Heater-Cathode Voltage:			
Heater negative with respect to cathode .....	200 max	200 max	volts
Heater positive with respect to cathode .....	200°max	200°max	volts
Direct Interelectrode Capacitances:			
Diode Unit:			
Plate to Cathode and Heater .....		1.8	pF
Cathode to Plate and Heater .....		3	pF
Pentode Unit:			
Grid No.1 to Plate .....		0.015 max	pF
Grid No.1 to Cathode, Heater, Grid No.2, No.3 and Internal Shield .....		6.5	pF
Plate to Cathode, Heater, Grid No.2, Grid No.3, and Internal Shield .....		2.6	pF
Pentode Grid No.1 to Diode Plate .....		0.006 max	pF
Pentode Plate to Diode Cathode .....		0.15 max	pF
Pentode Plate to Diode Plate .....		0.1 max	pF

\* The dc component must not exceed 100 volts.

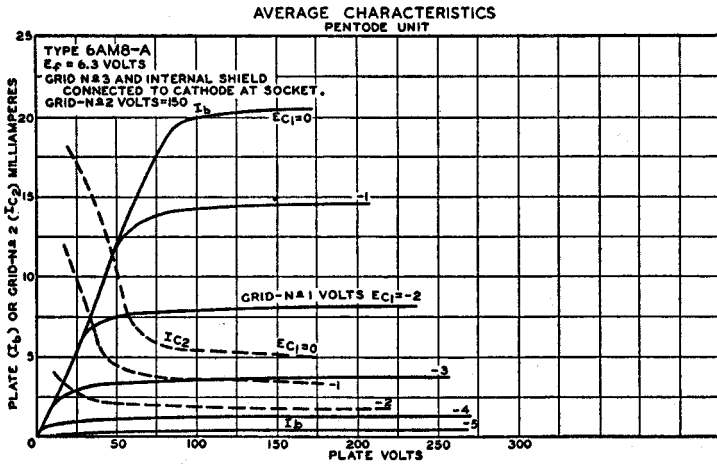

92CM-8505T2

**Pentode Unit as Class A<sub>1</sub> Amplifier**

**MAXIMUM RATINGS (Design-Maximum Values):**

Plate Voltage .....	330 max	volts
Grid-No.3 (Suppressor-Grid) Voltage, Positive value .....	0 max	volts
Grid-No.2 (Screen-Grid) Supply Voltage .....	330 max	volts
Grid-No.2 Voltage .....	See curve page 80	
Grid-No.1 (Control-Grid) Voltage, Positive-bias value .....	0 max	volts
Plate Dissipation .....	3.2 max	watts
Grid-No.2 Input:		
For grid-No.2 voltages up to 165 volts .....	0.55 max	watt
For grid-No.2 voltages between 165 and 330 volts .....	See curve page 80	

**CHARACTERISTICS:**

Plate Supply Voltage .....	125	volts
Grid No.3 .....	Connected to cathode at socket	
Grid-No.2 Supply Voltage .....	125	volts
Cathode-Bias Resistor .....	56	ohms
Plate Resistance (Approx.) .....	0.3	megohm
Transconductance .....	7800	μmhos
Grid-No.1 Voltage (Approx.) for plate current of 20 μA .....	-6	volts
Grid-No.1 Voltage (Approx.) for plate current of 2 mA and cathode-bias resistor of 0 ohms .....	-3	volts
Plate Current .....	12.5	mA
Grid-No.2 Current .....	3.2	mA

**MAXIMUM CIRCUIT VALUES:**

Grid-No.1-Circuit Resistance:

For fixed-bias operation .....	0.25 max megohm
For cathode-bias operation .....	1.0 max megohm

**Diode Unit**

**MAXIMUM RATINGS (Design-Maximum Values):**

DC Plate Current .....	5 max mA
------------------------	----------

**HIGH-MU TRIODE**

**6AN4**

Miniature type used as mixer or rf amplifier in cathode-drive circuits of uhf television tuners covering the frequency range of 470 to 890 megacycles per second. Outline 5B, **Outlines** section. Tube requires miniature seven-contact socket and may be mounted in any position.

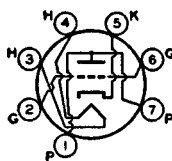

**7DK**

Heater Voltage (ac/dc) .....	6.3	volts
Heater Current .....	0.225	ampere
Peak Heater-Cathode Voltage:		
Heater negative with respect to cathode .....	200 max	volts
Heater positive with respect to cathode .....	200*max	volts
Direct Interelectrode Capacitances:		
Grid to Plate .....	1.7°	pF
Grid to Cathode and Heater .....	3.3°	pF
Plate to Cathode and Heater .....	1.8°	pF
Heater to Cathode .....	2.9*	pF
Grid to Cathode .....	2.6*	pF
Plate to Cathode .....	0.18*	pF
Cathode to Grid and Heater .....	5.7*	pF
Plate to Grid and Heater .....	3.4*	pF

- \* The dc component must not exceed 100 volts.
- ° With external shield connected to cathode.
- ^ With external shield connected to ground.
- \* With external shield connected to grid.

**Class A<sub>1</sub> Amplifier**

**MAXIMUM RATINGS (Design-Center Values):**

Plate Voltage .....	300 max	volts
Plate Dissipation .....	4 max	watts
Cathode Current .....	30 max	mA

**CHARACTERISTICS:**

Plate-Supply Voltage .....	200	volts
Cathode-Bias Resistor .....	100	ohms
Amplification Factor .....	70	
Transconductance .....	10000	μmhos
Plate Current .....	13	mA
Grid Voltage (Approx.) for plate current of 20 μA .....	-7	volts

**MAXIMUM CIRCUIT VALUES:**

Grid-Circuit Resistance:		
For fixed-bias operation .....	0.1 max	megohm
For cathode-bias operation .....	0.5 max	megohm

**MEDIUM-MU TRIODE—SHARP-CUTOFF PENTODE**

**6AN8A**

Related type:  
5AN8

Miniature type used in a wide variety of applications in color television receivers employing series-connected heater strings. The pentode unit is used as an intermediate-frequency amplifier, a video amplifier, an agc

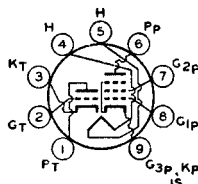

**9DA**

amplifier, or as a reactance tube. The triode unit is used in low-frequency oscillator, sync-separator, sync-clipper, and phase-splitter circuits. Outline 6B, **Outlines** section. Tube requires miniature nine-contact socket and may be mounted in any position. Type 5AN8 is identical with type 6AN8A except for heater ratings, as shown below.

	<b>5AN8</b>	<b>6AN8A</b>	
Heater Voltage (ac/dc) .....	4.7	6.3	volts
Heater Current .....	0.6	0.45	ampere
Heater Warm-Up Time (Average) .....	11	11	seconds
<b>Peak Heater-Cathode Voltage:</b>			
Heater negative with respect to cathode .....	200 max	200 max	volts
Heater positive with respect to cathode .....	200° max	200° max	volts
<b>Direct Interelectrode Capacitances:</b>			
<b>Triode Unit:</b>			
Grid to Plate .....		1.5	pF
Grid to Cathode and Heater .....		2.0	pF
Plate to Cathode and Heater .....		0.26	pF
<b>Pentode Unit:</b>			
Grid No.1 to Plate .....		0.04 max	pF
Grid No.1 to Cathode, Heater, Grid No.2, Grid No.3, and Internal Shield .....		7	pF
Plate to Cathode, Heater, Grid No.2, Grid No.3, and Internal Shield .....		2.4	pF
Triode Grid to Pentode Plate .....		0.02	pF
Pentode Grid No.1 to Triode Plate .....		0.02	pF
Pentode Plate to Triode Plate .....		0.15	pF

° The dc component must not exceed 100 volts.

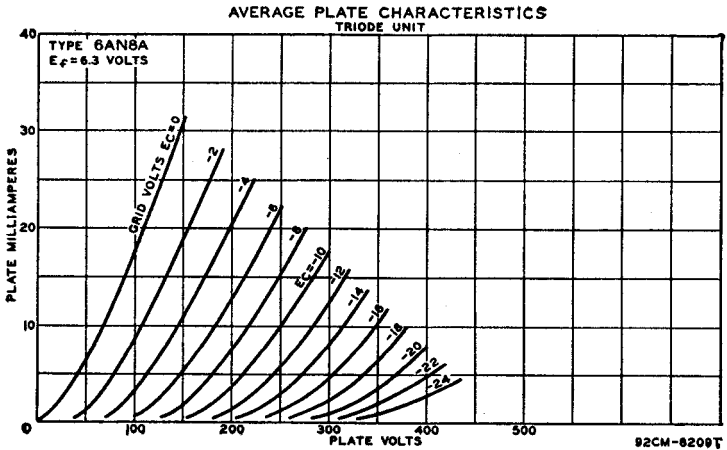

**Class A<sub>1</sub> Amplifier**

<b>MAXIMUM RATINGS</b> (Design-Maximum Values):	Triode Unit	Pentode Unit	
Plate Voltage .....	330 max	330 max	volts
Grid-No.2 Supply Voltage .....	—	330 max	volts
Grid-No.2 (Screen-Grid) Voltage .....	—	See curve page 80	
Grid-No.1 (Control-Grid) Voltage, Positive-bias value .....	0 max	0 max	volts
Plate Dissipation .....	2.8 max	2.3 max	watts
<b>Grid-No.2 Input:</b>			
For grid-No.2 voltages up to 165 volts .....	—	0.55 max	watt
For grid-No.2 voltages between 165 and 330 volts .....	—	See curve page 80	

**CHARACTERISTICS:**

Plate Supply Voltage .....	150	125	volts
Grid-No.2 Supply Voltage .....	—	125	volts
Grid-No.1 Voltage .....	-3	—	volts

Cathode-Bias Resistor .....	—	56	ohms
Amplification Factor .....	21	—	
Plate Resistance (Approx.) .....	4700	17000	ohms
Transconductance .....	4500	7800	$\mu$ hos
Grid-No.1 Voltage (Approx.) for plate current of 20 $\mu$ A .....	-17	-6	volts
Grid-No.1 Voltage (Approx.) for plate current of 1.6 mA and cathode-bias resistor of 0 ohms .....	—	-3	volts
Plate Current .....	15	12	mA
Grid-No.2 Current .....	—	3.8	mA

**MAXIMUM CIRCUIT VALUES:**

Grid-No.1-Circuit Resistance:\*

For fixed-bias operation .....	0.5 max	0.25 max	megohm
For cathode-bias operation .....	1.0 max	1.0 max	megohm

\* If either unit is operating at maximum rated conditions, grid-No.1-circuit resistance for both units should not exceed the stated values.

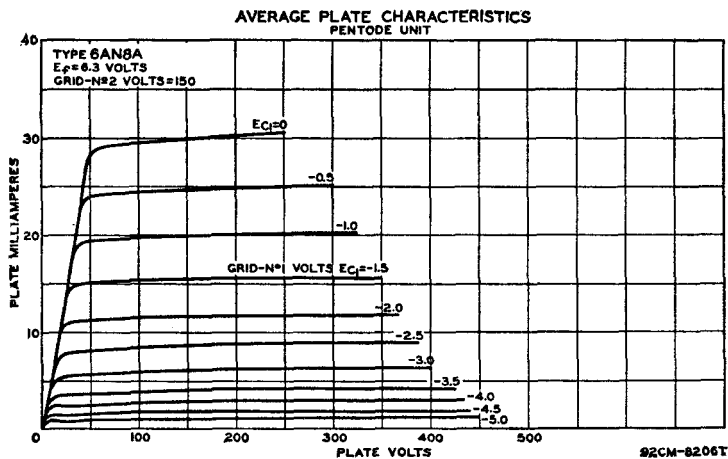
**BEAM POWER TUBE****6AQ5A**

Related types:  
5AQ5, 12AQ5

Miniature type used as output amplifier primarily in automobile receivers and in ac-operated receivers and, triode-connected, as a vertical deflection amplifier in television receivers employing series-connected heater

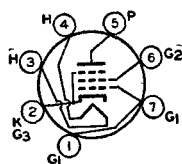
**7BZ**

strings. Outline 5D, **Outlines** section. Tube requires miniature seven-contact socket and may be mounted in any position. Within its maximum ratings, the performance of this type is equivalent to that of larger types 6V6 and 6V6GTA. Types 5AQ5 and 12AQ5 are identical with type 6AQ5A except for heater ratings, as shown below.

	5AQ5	6AQ5A	12AQ5	
Heater Voltage (ac/dc) .....	4.7	6.3	12.6	volts
Heater Current .....	0.6	0.45	0.225	ampere
Heater Warm-up Time (Average) .....	11	11	—	seconds
Peak Heater-Cathode Voltage:				
Heater negative with respect to cathode .	200 max	200 max	200 max	volts
Heater positive with respect to cathode .	200*max	200*max	200*max	volts

\* The dc component must not exceed 100 volts.



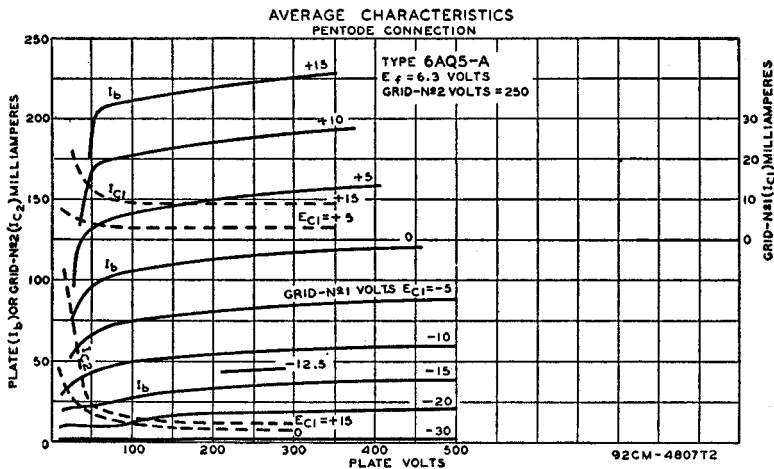

Direct Interelectrode Capacitances (Approx.):

Grid No.1 to Plate .....	0.4	pF
Grid No.1 to Cathode, Heater, Grid No.2, and Grid No.3 .....	8	pF
Plate to Cathode, Heater, Grid No.2, and Grid No.3 .....	8.5	pF
Amplification Factor* .....	9.5	
Plate Resistance (Approx.)* .....	1970	ohms
Transconductance* .....	4800	$\mu$ mhos
Grid-No.1 Voltage (Approx.) for plate current of 0.5 mA .....	-37	volts

\* Grid No.2 connected to plate; plate and grid-No.2 volts, 250; grid-No.1 volts, -12.5; plate mA, 49.5.

**Class A<sub>1</sub> Amplifier**

**MAXIMUM RATINGS** (Design-Maximum Values):

Plate Voltage .....	275 max	volts
Grid-No.2 (Screen-Grid) Voltage .....	275 max	volts
Plate Dissipation .....	12 max	watts
Grid-No.2 Input .....	2 max	watts
Bulb Temperature (At hottest point) .....	250 max	$^{\circ}$ C

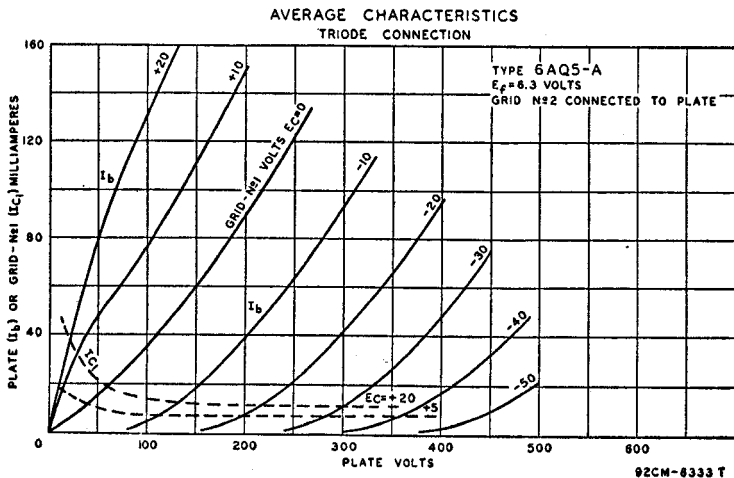

**TYPICAL OPERATION:**

Same as for type 6V6GTA within the limitations of the maximum ratings.

**MAXIMUM CIRCUIT VALUES:**

## Grid-No.1-Circuit Resistance:

For fixed-bias operation .....	0.1 max	megohm
For cathode-bias operation .....	0.5 max	megohm

**Vertical Deflection Amplifier (Triode Connection)<sup>o</sup>**

For operation in a 525-line, 30-frame system

**MAXIMUM RATINGS (Design-Maximum Values):**

DC Plate Voltage .....	275 max	volts
Peak Positive-Pulse Plate Voltage† .....	1100 max	volts
Peak Negative-Pulse Grid-No.1 (Control-Grid) Voltage .....	-275 max	volts
Peak Cathode Current .....	115 max	mA
Average Cathode Current .....	40 max	mA
Plate Dissipation .....	10 max	watts
Bulb Temperature (At hottest point) .....	250 max	°C

**MAXIMUM CIRCUIT VALUE:**

## Grid-No.1-Circuit Resistance:

For cathode-bias operation .....	2.2 max	megohms
----------------------------------	---------	---------

<sup>o</sup> Grid No.2 connected to plate.

† The duration of the voltage pulse must not exceed 15 per cent of one vertical scanning cycle. In a 525-line, 30-frame system, 15 per cent of one vertical scanning cycle is 2.5 milliseconds.

**6AQ8**  
**6AQ8/**  
**ECC85**

**HIGH-MU TWIN TRIODE**

Miniature types used as rf amplifier and self-oscillating mixer in FM/AM radio receivers. Outline 6B, **Outlines** section. Tubes require nine-contact socket and may be operated in any position.

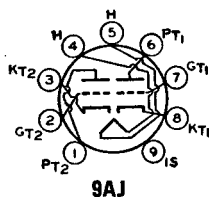

Heater Voltage (ac/dc) .....	6.3	volts
Heater Current .....	0.435	ampere
Peak Heater-Cathode Voltage:		
Heater negative with respect to cathode .....	90 max	volts
Heater positive with respect to cathode .....	90 max	volts
Direct Interelectrode Capacitances:		
	Unit No.1	Unit No.2
Grid to Plate .....	1.5	1.5
Cathode to Plate .....	0.18	0.18
Grid to Cathode, Heater, and Internal Shield .....	3	3
Plate to Cathode, Heater, and Internal Shield .....	1.2	1.2
Plate to Grid of Other Unit .....	0.008 max	0.008 max
Plate to Cathode of Other Unit .....	0.008 max	0.008 max
Grid to Cathode of Other Unit .....	0.003 max	0.003 max
Plate of Unit No.1 to Plate of Unit No.2 .....		0.04 max
Grid of Unit No.1 to Grid of Unit No.2 .....		0.003 max
Amplification Factor*	57	
Plate Resistance (Approx.)* .....	9700	ohms
Transconductance* .....	5900	μmhos

\* Each unit; with plate volts, 250; grid volts, -2.3; plate mA, 10.

**MAXIMUM RATINGS (Design-Center Values, Each Unit):**

Plate Supply Voltage .....	550 max	volts
Plate Voltage .....	300 max	volts
Grid Voltage, Negative-bias value .....	-100 max	volts
Plate Dissipation:		
For either plate .....	2.5 max	watts
For both plates with both units operating .....	4.5 max	watts
Cathode Current .....	15 max	mA

**TYPICAL OPERATION (Each Unit):**

	RF Amplifier	Converter	
Plate Supply Voltage	250	250	volts
Plate Voltage	230	—	volts
Plate Resistor	1800	12000	ohms
Grid Resistor	—	1	megohm
Grid Voltage	-2	—	volts
RMS Oscillator Voltage	—	3	volts
Cathode-Bias Resistor	200	—	ohms
Plate Resistance (Approx.)	9700	22000	ohms
Transconductance	6000	—	μmhos
Conversion Transconductance	—	2300	μmhos
Input Resistance at frequency of 100 Mc/s	6000	15000	ohms
Plate Current	10	5.2	mA
Equivalent Noise Resistance	500	—	ohms

**MAXIMUM CIRCUIT VALUES (Each Unit):**

Grid-Circuit Resistance	1 max	megohm
Resistance between Cathode and Heater	20000 max	ohms

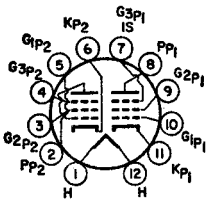

**12DM**

**SEMIREMOTE-CUTOFF TWIN PENTODE**

Duodecar type used as if-amplifier tube in television receivers. Outline 8A, **Outlines** section. Tube requires duodecar twelve-contact-socket and may be mounted in any position. Type 11AR11 is identical with type 6AR11 except for heater ratings, as show below.

**6AR11**

Related type: 11AR11

	6AR11	11AR11	
Heater Voltage (ac/dc)	6.3	11.2	volts
Heater Current	0.8	0.45	ampere
Heater Warm-up Time (Average)	—	11	seconds
<b>Peak Heater-Cathode Voltage:</b>			
Heater negative with respect to cathode	200 max	200 max	volts
Heater positive with respect to cathode	200*max	200*max	volts
<b>Direct Interelectrode Capacitances:</b>			
Grid No.1 to Plate	0.026	0.026	pF
Grid No.1 to Cathode, Heater, Grid No.2, Grid No.3, and Internal Shield	10	10	pF
Plate to Cathode, Heater, Grid No.2, Grid No.3, and Internal Shield	2.8	3	pF
Grid No.1 to Plate of Other Unit	0.002 max	0.002 max	pF
Plate of Unit No.1 to Plate of Unit No.2		0.02 max	pF

\* The dc component must not exceed 100 volts.

**Class A<sub>1</sub> Amplifier**

**MAXIMUM RATINGS (Design-Maximum Values, Each Unit):**

Plate Voltage	330 max	volts
Grid-No.3 (Suppressor-Grid) Voltage, Positive value	0 max	volts
Grid-No.2 (Screen-Grid) Supply Voltage	330 max	volts
Grid-No.2 Voltage	See curve page 80	
Grid-No.1 (Control-Grid) Voltage, Positive-bias value	0 max	volts
<b>Grid-No.2 Input:</b>		
For grid-No.2 voltages up to 165 volts	0.65 max	watt
For grid-No.2 voltages between 165 and 330 volts	See curve page 80	
Plate Dissipation	3.1 max	watts

**CHARACTERISTICS (Each Unit):**

Plate Supply Voltage	125	volts
Grid No.3	Connected to cathode at socket	
Grid-No.2 Supply Voltage	125	volts
Cathode-Bias Resistor	56	ohms

Plate Resistance (Approx.) .....	0.2	megohm
Transconductance .....	10500	$\mu$ hos
Plate Current .....	11	mA
Grid-No.2 Current .....	3.5	mA
Grid-No.1 Voltage (Approx.) for transconductance of 50 $\mu$ hos .....	-15	volts

### BEAM POWER TUBE

## 6AS5

Miniature type used as output amplifier primarily in automobile and in ac-operated receivers. Outline 5D, **Outlines** section. Tube requires miniature seven-contact socket and may be mounted in any position. For curves

of average plate characteristics, refer to type 35C5.

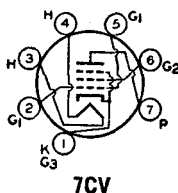

Heater Voltage (ac/dc) .....	6.3	volts
Heater Current .....	0.8	ampere
Peak Heater-Cathode Voltage:		
Heater negative with respect to cathode .....	100 max	volts
Heater positive with respect to cathode .....	100 max	volts
Direct Interelectrode Capacitances (Approx.):		
Grid No.1 to Plate .....	0.6	pF
Grid No.1 to Cathode, Heater, Grid No.2, and Grid No.3 .....	12	pF
Plate to Cathode, Heater, Grid No.2, and Grid No.3 .....	9.0	pF

### Class A<sub>1</sub> Amplifier

#### MAXIMUM RATINGS (Design-Center Values):

Plate Voltage .....	150 max	volts
Grid-No.2 (Screen-Grid) Voltage .....	117 max	volts
Plate Dissipation .....	5.5 max	watts
Grid-No.2 Input .....	1.0 max	watt
Bulb Temperature (At hottest point) .....	250 max	°C

#### TYPICAL OPERATION:

Plate Voltage .....	150	volts
Grid-No.2 Voltage .....	110	volts
Grid-No.1 (Control-Grid) Voltage .....	-8.5	volts
Peak AF Grid-No.1 Voltage .....	8.5	volts
Zero-Signal Plate Current .....	35	mA
Maximum-Signal Plate Current .....	36	mA
Zero-Signal Grid-No.2 Current (Approx.) .....	2	mA
Maximum-Signal Grid-No.2 Current (Approx.) .....	6.5	mA
Transconductance .....	5600	$\mu$ hos
Load Resistance .....	4500	ohms
Total Harmonic Distortion .....	10	per cent
Maximum-Signal Power Output .....	2.2	watts

#### MAXIMUM CIRCUIT VALUES:

Grid-No.1-Circuit Resistance:		
For fixed-bias operation .....	0.1 max	megohm
For cathode-bias operation .....	0.5 max	megohm

### DIODE— SHARP-CUTOFF PENTODE

## 6AS8

Related type:  
5AS8

Miniature type used in diversified applications in television and radio receivers. The pentode unit is used as an if amplifier, video amplifier, or agc amplifier. The high-perveance diode is used as an audio detector, video de-

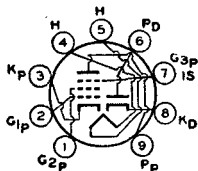

**9DS**

rector, or dc restorer. Outline 6B, **Outlines** section. Tube requires miniature nine-contact socket and may be mounted in any position. For curve of average plate characteristics of pentode unit, see type 6AN8A. Type 5AS8 is identical with type 6AS8 except for heater ratings, as shown below.

	<b>5AS8</b>	<b>6AS8</b>	
Heater Voltage (ac/dc) .....	4.7	6.3	volts
Heater Current .....	0.6	0.45	ampere
Heater Warm-up Time (Average) .....	11	—	seconds
Peak Heater-Cathode Voltage:			
Heater negative with respect to cathode .....	200 max	200 max	volts
Heater positive with respect to cathode .....	200*max	200*max	volts
Direct Interelectrode Capacitances:			
Diode Unit:			
Plate to Cathode, Heater, Pentode Grid No.3, and Internal Shield .....		3.0	pF
Pentode Unit:			
Grid No.1 to Plate .....		0.03 max	pF
Grid No.1 to Cathode, Heater, Grid No.2, Grid No.3, and Internal Shield .....		7	pF
Plate to Cathode, Heater, Grid No.2, Grid No.3, and Internal Shield .....		2.4	pF
Pentode Grid No.1 to Diode Plate .....		0.005 max	pF
Pentode Plate to Diode Cathode .....		0.15 max	pF
Pentode Plate to Diode Plate .....		0.10 max	pF

■ The dc component must not exceed 100 volts.

**Pentode Unit As Class A<sub>1</sub> Amplifier**

**MAXIMUM RATINGS (Design-Center Values):**

Plate Voltage .....	300 max	volts
Grid-No.3 (Suppressor-Grid) Voltage, Positive value .....	0 max	volts
Grid-No.2 Supply Voltage .....	300 max	volts
Grid-No.2 (Screen-Grid) Voltage .....		See curve page 80
Grid-No.1 (Control-Grid) Voltage, Positive bias value .....	0 max	volts
Plate Dissipation .....	2.5 max	watts
Grid-No.2 Input:		
For grid-No.2 voltages up to 150 volts .....	0.5 max	watt
For grid-No.2 voltages between 150 and 300 volts .....		See curve page 80

**CHARACTERISTICS:**

Plate Supply Voltage .....	200	volts
Grid No.3 .....	Connected to cathode at socket	
Grid-No.2 Supply Voltage .....	150	volts
Cathode-Bias Resistor .....	180	ohms
Plate Resistance (Approx.) .....	300000	ohms
Transconductance .....	6200	μmhos
Grid-No.1 Voltage (Approx.) for plate current of 10 μA .....	—8	volts
Plate Current .....	9.5	mA
Grid-No.2 Current .....	3	mA

**MAXIMUM CIRCUIT VALUES:**

Grid-No.1-Circuit Resistance:		
For fixed-bias operation .....	0.25 max	megohm
For cathode-bias operation .....	1.0 max	megohm

**Diode Unit**

**MAXIMUM RATINGS (Design-Center Values):**

Peak Inverse Plate Voltage .....	330 max	volts
Peak Plate Current .....	50 max	mA
DC Plate Current .....	5 max	mA

### TWIN DIODE— HIGH-MU TRIODE

## 6AT6

Related type:  
12AT6

Miniature type used as a combined detector, amplifier, and avc tube in automobile and ac-operated radio receivers. Outline 5C, **Outlines** section. Tube requires miniature seven-contact socket and may be mounted in any

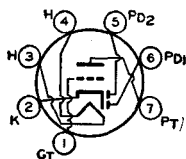

### 7BT

position. For typical operation as resistance-coupled amplifier, refer to **Resistance-Coupled Amplifier** section. Type 12AT6 is identical with type 6AT6 except for heater ratings, as shown below.

Heater Voltage (ac/dc)	6AT6 6.3	12AT6 12.6	volts
Heater Current	0.3	0.15	ampere
Peak Heater-Cathode Voltage:			
Heater negative with respect to cathode		90 max	volts
Heater positive with respect to cathode		90 max	volts
Direct Interelectrode Capacitances:			
Triode Grid to Triode Plate		2.0	pF
Triode Grid to Cathode and Heater		2.2	pF
Triode Plate to Cathode and Heater		0.8	pF
Plate of Diode Unit No.2 to Triode Grid		0.04 max	pF

### Triode Unit As Class A<sub>1</sub> Amplifier

#### MAXIMUM RATINGS (Design-Center Values):

Plate Voltage		300 max	volts
Plate Dissipation		0.5 max	watts
Grid Voltage, Positive-bias value		0 max	volts

#### CHARACTERISTICS:

Plate Voltage	100	250	volts
Grid Voltage	-1	-3	volts
Amplification Factor	70	70	
Plate Resistance	54000	58000	ohms
Transconductance	1300	1200	μmhos
Plate Current	0.8	1.0	mA

### Diode Units

#### MAXIMUM RATING (Design-Center Value):

Plate Current (Each Unit)	1.0 max	mA
---------------------------	---------	----

The two diode plates are placed around a cathode, the sleeve of which is common to the triode unit. Each diode plate has its own base pin. For diode operation curves, refer to type 6AV6.

### MEDIUM-MU TRIODE— SHARP-CUTOFF PENTODE

## 6AT8A

Related type:  
5AT8

Miniature types used as combined oscillator and mixer tubes in television receivers utilizing an intermediate frequency in the order of 40 megacycles per second. This type has a controlled heater warm-up time for use in receivers

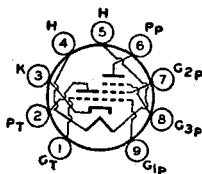

### 9DW

employing series-connected heater strings. Outline 6B, **Outlines** section. Except for interelectrode capacitances and basing arrangement, this type is identical with miniature type 6X8. The basing arrangement is particularly suitable for connection to the coils of certain designs of turret tuners. Type 5AT8 is identical with type 6AT8A except for heater ratings, as shown below.

Heater Voltage (ac/dc)	5AT8 4.7	6AT8A 6.3	volts
Heater Current	0.6	0.45	ampere
Heater Warm-up Time (Average)	11	11	seconds

Direct Interelectrode Capacitances:	Without External Shield	With External Shield*	
<b>Triode Unit:</b>			
Grid to Plate .....	1.5	1.5	pF
Grid to Cathode and Heater .....	2.0	2.4	pF
Plate to Cathode and Heater .....	0.5	1.0	pF
<b>Pentode Unit:</b>			
Grid No.1 to Plate .....	0.06 max	0.03 max	pF
Grid No.1 to Cathode, Heater, Grid No.2 and Grid No.3 .....	4.6	4.8	pF
Plate to Cathode, Heater, Grid No.2, and Grid No.3 .....	0.9	1.6	pF
Pentode Grid No.1 to Triode Plate .....	0.05 max	0.04 max	pF
Pentode Plate to Triode Plate .....	0.05 max	0.008 max	pF
Heater to Cathode .....	6.0	6.0†	pF

\* With external shield connected to cathode except as noted.  
 † With external shield connected to plate.

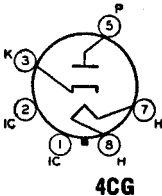

4CG

### HALF-WAVE VACUUM RECTIFIER

## 6AU4GTA

Glass octal type used as damper tube in horizontal-deflection circuits of color television receivers and of television receivers utilizing picture tubes having wide-angle deflection. Outline 13G, **Outlines** section. This type re-

quires octal socket and may be mounted in any position. Type may be supplied with pin No.1 omitted. Socket terminals 1, 2, 4, and 6 should not be used as tie points. It is especially important that this tube, like other power-handling tubes, be adequately ventilated.

Heater Voltage (ac/dc) .....	6.3	volts
Heater Current .....	1.8	amperes
<b>Direct Interelectrode Capacitances (Approx.):</b>		
Plate to Heater and Cathode .....	8.5	pF
Cathode to Heater and Plate .....	11.5	pF
Heater to Cathode .....	4.0	pF

### Damper Service

For operation in a 525-line, 30-frame system

#### MAXIMUM RATINGS (Design-Maximum Values):

Peak Inverse Plate Voltage† .....	4500 max	volts
Peak Plate Current .....	1300 max	mA
DC Plate Current .....	210 max	mA
Plate Dissipation .....	6.5 max	watts
<b>Peak Heater-Cathode Voltage:</b>		
Heater negative with respect to cathode .....	4500*max	volts
Heater positive with respect to cathode .....	300#max	volts

† The duration of the voltage pulse must not exceed 15 per cent of one horizontal scanning cycle. In a 525-line, 30-frame system, 15 per cent of one horizontal scanning cycle is 10 microseconds.

\* The dc component must not exceed 900 volts.

# The dc component must not exceed 100 volts.

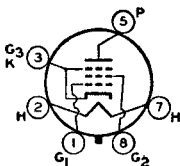

6CK

### BEAM POWER TUBE

## 6AU5GT

Glass octal type used as horizontal deflection amplifier in low-cost, high-efficiency deflection circuits of television receivers employing either transformer coupling or direct coupling to the deflecting yoke. Outline

13D, **Outlines** section. Tube requires octal socket and may be mounted in any position.

Heater Voltage (ac/dc) .....	6.3	volts
Heater Current .....	1.25	amperes
Peak Heater-Cathode Voltage:		
Heater negative with respect to cathode .....	200 max	volts
Heater positive with respect to cathode .....	200 max	volts
Direct Interelectrode Capacitances (Approx.):		
Grid No.1 to Plate .....	0.5	pF
Grid No.1 to Cathode, Heater, Grid No.2, and Grid No.3 .....	11.3	pF
Plate to Cathode, Heater, Grid No.2, and Grid No.3 .....	7.0	pF
Transconductance# .....	5600	μmhos
Mu-Factor, Grid No.2 to Grid No.1† .....	5.9	

▪ The dc component must not exceed 100 volts.

# For plate volts, 115; grid-No.2 volts, 175; grid-No.1 volts, -20.

† For plate volts, 100; grid-No.2 volts, 100; grid-No.1 volts, -4.5.

### Horizontal Deflection Amplifier

For operation in a 525-line, 30-frame system

#### MAXIMUM RATINGS (Design-Center Values):

DC Plate Voltage .....	550 max	volts
Peak Positive-Pulse Plate Voltage* (Absolute Maximum) .....	5500° max	volts
Peak Negative-Pulse Plate Voltage .....	-1250 max	volts
DC Grid-No.2 (Screen-Grid) Voltage* .....	200 max	volts
Peak Negative-Pulse Grid-No.1 (Control-Grid) Voltage .....	-300 max	volts
Peak Cathode Current .....	400 max	mA
Average Cathode Current .....	110 max	mA
Grid-No.2 Input .....	2.5 max	watts
Plate Dissipation†† .....	10 max	watts
Bulb Temperature (At hottest point) .....	210 max	°C

#### MAXIMUM CIRCUIT VALUE:

Grid-No.1-Circuit Resistance .....	0.47 max megohm
------------------------------------	-----------------

\* The duration of the voltage pulse must not exceed 15 per cent of one horizontal scanning cycle. In a 525-line, 30-frame system, 15 per cent of one horizontal scanning cycle is 10 microseconds.

° Under no circumstances should this absolute value be exceeded.

\* Obtained through a series dropping resistor of sufficient magnitude to limit the grid-No.2 input to the rated maximum value.

†† An adequate bias resistor or other means is required to protect the tube in the absence of excitation.

### SHARP-CUTOFF PENTODE

Miniature type used in compact radio equipment as rf amplifier especially in high-frequency, wide-band applications; also used as limiter tube in FM equipment. Type 6AU6A has a controlled heater warm-up time for

## 6AU6A

Related types:

3AU6, 4AU6, 12AU6

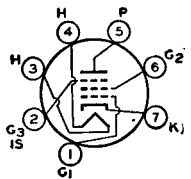

7BK

use in applications employing series-connected heater strings. Outline 5C, **Outlines** section. Type requires miniature seven-contact socket and may be operated in any position. For a discussion of limiters, refer to **Electron Tube Applications** section. For typical operation as resistance-coupled amplifier, refer to **Resistance-Coupled Amplifier** section. Types 3AU6, 4AU6, and 12AU6 are identical with type 6AU6A except for heater ratings, as shown below.

	3AU6	4AU6	6AU6A	12AU6	
Heater Voltage (ac/dc) .....	3.15	4.2	6.3	12.6	volts
Heater Current .....	0.6	0.45	0.3	0.15	ampere
Heater Warm-up Time (Average) ....	11	11	11	—	seconds



Peak Heater-Cathode Voltage:

Heater negative with respect to cathode .....	200 max	volts
Heater positive with respect to cathode .....	200 <sup>a</sup> max	volts

Direct Interelectrode Capacitances:

Pentode Connection:

Grid No.1 to Plate .....	0.0035 max	pF
Grid No.1 to Cathode, Heater, Grid No.2, Grid No.3, and Internal Shield .....	5.5	pF
Plate to Cathode, Heater, Grid No.2, Grid No.3, and Internal Shield .....	5.0	pF

Triode Connection:†

Grid No.1 to Plate, Grid No.2, Grid No.3, and Internal Shield .....	2.6	pF
Grid No.1 to Cathode and Heater .....	3.2	pF
Plate, Grid No.2, Grid No.3, and Internal Shield to Cathode and Heater .....	1.2 <sup>a</sup>	pF

<sup>a</sup> The dc component must not exceed 100 volts.

† Grid No.2, grid No.3, and internal shield connected to plate.

<sup>a</sup> Value is 8.5 pF with external shield connected to cathode.

Class A<sub>1</sub> Amplifier

MAXIMUM RATINGS (Design-Maximum Values):

	Triode† Connection	Pentode Connection	
Plate Voltage .....	275 max	330 max	volts
Grid-No.3 (Suppressor-Grid) Voltage, Positive value ..	—	0 max	volts
Grid-No.2 (Screen-Grid) Voltage .....	—	See curve page 80	
Grid-No.2 Supply Voltage .....	—	330 max	volts
Plate Dissipation .....	3.5 max	3.5 max	watts
Grid-No.2 Input:			
For grid-No.2 voltages up to 165 volts .....	—	0.75 max	watt
For grid-No.2 voltages between 165 and 330 volts ..	—	See curve page 80	
Grid-No.1 (Control-Grid) Voltage:			
Positive-bias value .....	0 max	0 max	volts

CHARACTERISTICS:

	Triode† Connection		Pentode Connection		
Plate Supply Voltage .....	250	100	250	250	volts
Grid No.3 .....	—	Connected to cathode at socket	—	—	
Grid-No.2 Supply Voltage .....	—	100	125	150	volts
Cathode-Bias Resistor .....	330	150	100	68	ohms
Amplification Factor .....	36	—	—	—	
Plate Resistance (Approx.) .....	—	0.5	1.5	1.0	megohms
Transconductance .....	4800	3900	4500	5200	μmhos
Grid-No.1 Voltage for plate current					
of 10 μA .....	—	-4.2	-5.5	-6.5	volts
Plate Current .....	12.2	5.0	7.6	10.6	mA
Grid-No.2 Current .....	—	2.1	3.0	4.3	mA

† Grid No.2, grid No.3, and internal shield connected to plate.

AVERAGE CHARACTERISTICS

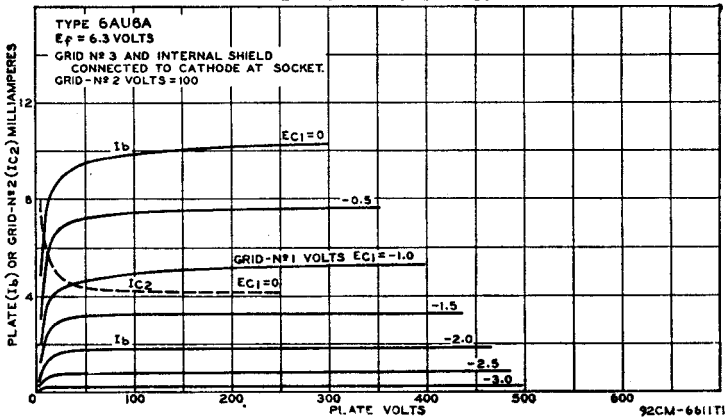

### MEDIUM-MU TRIODE— SHARP-CUTOFF PENTODE

## 6AU8A

Related type:  
8AU8

Miniature type used in television receiver applications. This type has controlled heater warm-up time for use in series-heater strings. Pentode unit is used as video amplifier, if amplifier, agc amplifier. Triode unit is used in

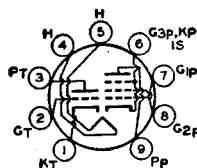

90X

sync-amplifier, sync-separator, sync-clipper, and phase-inverter circuits. Outline 6E, **Outlines** section. This type requires nine-contact socket and may be mounted in any position. Type 8AU8 is identical with type 6AU8A except for heater ratings, as shown below.

	6AU8A	8AU8	
Heater Voltage (ac/dc) .....	6.3	8.4	volts
Heater Current .....	0.6	0.45	ampere
Heater Warm-up Time (Average) .....	11	—	seconds
Peak Heater-Cathode Voltage:			
Heater negative with respect to cathode .....	200 max	200 max	volts
Heater positive with respect to cathode .....	200*max	200*max	volts
Direct Interelectrode Capacitances:			
Triode Unit:			
Grid to Plate .....		2.2	pF
Grid to Cathode and Heater .....		2.6	pF
Plate to Cathode and Heater .....		0.34	pF
Pentode Unit:			
Grid No.1 to Plate .....		0.06	pF
Grid No.1 to Cathode, Heater, Grid No.2, Grid No.3, and Internal Shield .....		7.5	pF
Plate to Cathode, Heater, Grid No.2, Grid No.3, and Internal Shield .....		3.4	pF
Triode Grid to Pentode Plate .....		0.022 max	pF
Pentode Grid No.1 to Triode Plate .....		0.006 max	pF
Pentode Plate to Triode Plate .....		0.12 max	pF

• The dc component must not exceed 100 volts.

#### MAXIMUM RATINGS (Design-Maximum Values):

	Triode Unit	Pentode Unit	
Plate Voltage .....	330 max	330 max	volts
Grid-No.2 (Screen-Grid) Supply Voltage .....	—	330 max	volts
Grid-No.2 Voltage .....	—	See curve page 80	
Grid-No.1 (Control-Grid) Voltage, Positive-bias value .....	0 max	0 max	volts
Plate Dissipation .....	2.8 max	3.3 max	watts
Grid-No.2 Input:			
For grid-No.2 voltages up to 165 volts .....	—	1 max	watt
For grid-No.2 voltages between 165 and 330 volts .....	—	See curve page 80	

#### CHARACTERISTICS:

Plate Supply Voltage .....	150	200	volts
Grid-No.2 Supply Voltage .....	—	125	volts
Cathode-Bias Resistor .....	150	82	ohms
Amplification Factor .....	43	—	
Plate Resistance (Approx.) .....	8100	100000	ohms
Transconductance .....	5300	8000	$\mu$ mhos
Grid-No.1 Voltage (Approx.) for plate current of 100 $\mu$ A .....	—6.5	—7.5	volts
Plate Current .....	9.5	17	mA
Grid-No.2 Current .....	—	3.4	mA

#### MAXIMUM CIRCUIT VALUES:

##### Grid-No.1-Circuit Resistance:

For fixed-bias operation .....	0.5 max	0.25 max	megohm
For cathode-bias operation .....	1.0 max	1.0 max	megohm



**6CK**

and may be mounted in any position. Types 12AV5GA and 25AV5GA are identical with type 6AV5GA except for heater ratings, as shown below.

**BEAM POWER TUBE**

Glass octal type used as horizontal deflection amplifier in television receivers employing either transformer coupling or direct coupling to the deflecting yoke. Outline 19C, **Outlines** section. This type requires octal socket

**6AV5GA**

**Related types:**  
12AV5GA, 25AV5GA

	6AV5GA	12AV5GA	25AV5GA	
Heater Voltage (ac/dc) .....	6.3	12.6	25	volts
Heater Current .....	1.2	0.6	0.3	amperes
Heater Warm-up Time (Average) .....	—	11	—	seconds
Peak Heater-Cathode Voltage:				
Heater negative with respect to cathode ..	200 max	200 max	200 max	volts
Heater positive with respect to cathode ..	200*max	200*max	200*max	volts
Transconductance*			5900	μmhos
Mu Factor, Grid No.2 to Grid No.1** .....			4.3	

- The dc component must not exceed 100 volts.
- \* Plate volts, 250; grid-No.2 volts, 150; grid-No.1 volts, -22.5.
- \*\* Triode connected; plate and grid-No.2 volts, 150; grid-No.1 volts, -22.5.

**Horizontal Deflection Amplifier**

For operation in a 525-line, 30-frame system

**MAXIMUM RATINGS (Design-Center Values):**

DC Plate Voltage .....	550 max	volts
Peak Positive-Pulse Plate Voltage† (Absolute Maximum) .....	5500°max	volts
Peak Negative-Pulse Plate Voltage .....	-1250 max	volts
DC Grid-No.2 (Screen-Grid) Voltage .....	175 max	volts
Peak Negative-Pulse Grid-No.1 (Control-Grid) Voltage .....	-300 max	volts
Peak Cathode Current .....	400 max	mA
Average Cathode Current .....	110 max	mA
Grid-No.2 Input .....	2.5 max	watts
Plate Dissipation†† .....	11 max	watts
Bulb Temperature (at hottest point) .....	210 max	°C

**MAXIMUM CIRCUIT VALUE:**

Grid-No.1 Circuit Resistance .....	0.47 max megohm
------------------------------------	-----------------

† The duration of the voltage pulse must not exceed 15 per cent of one horizontal scanning cycle. In a 525-line, 30-frame system, 15 per cent of one horizontal scanning cycle is 10 microseconds.

° Under no circumstances should this absolute value be exceeded.

†† An adequate bias resistor or other means is required to protect the tube in the absence of excitation.

**TWIN DIODE—  
HIGH-MU TRIODE**

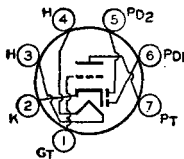

**7BT**

Miniature type used as combined detector, amplifier, and avc tube in automobile and ac-operated radio receivers. The 6AV6 may be substituted directly for the 6AT6 in applications where the higher ampli-

**6AV6**

**Related types:**  
3AV6, 4AV6, 12AV6

fication of the 6AV6 is advantageous. Types 3AV6, 4AV6, and 12AV6 are identical with type 6AV6 except for heater ratings, as shown below.

	3AV6	4AV6	6AV6	12AV6	
Heater Voltage (ac/dc) .....	3.15	4.2	6.3	12.6	volts
Heater Current .....	0.6	0.45	0.3	0.15	ampere
Heater Warm-up Time (Average) .....	11	11	—	—	seconds
Peak Heater-Cathode Voltage:					
Heater negative with respect to cathode .....				200 max	volts
Heater positive with respect to cathode .....				200 max	volts
Direct Interelectrode Capacitances:					
Triode Grid to Triode Plate .....				2.0	pF
Triode Grid to Cathode and Heater .....				2.2	pF
Triode Plate to Cathode and Heater .....				0.8*	pF
Plate of Diode Unit No.2 to Triode Grid .....				0.04 max	pF

\* The dc component must not exceed 100 volts.

\* This value is 1.2 pF with external shield connected to cathode.

### Triode Unit As Class A<sub>1</sub> Amplifier

#### MAXIMUM RATING (Design-Maximum Value):

Plate Voltage .....	330 max	volts
Grid Voltage, Positive-bias value .....	0 max	volts
Plate Dissipation .....	0.55 max	watt

#### CHARACTERISTICS:

Plate Voltage .....	100	250	volts
Grid Voltage .....	-1	-2	volts
Amplification Factor .....	100	100	
Plate Resistance .....	80000	62500	ohms
Transconductance .....	1250	1600	μmhos
Plate Current .....	0.50	1.2	mA

### Diode Units

#### MAXIMUM RATING (Design-Maximum Value):

Plate Current (Each Unit) .....	1.0 max	mA
---------------------------------	---------	----

The two diode plates are placed around a cathode, the sleeve of which is common to the triode unit. Each diode plate has its own base pin. Diode biasing of the triode unit is not recommended.

## Installation and Application

Type 6AV6 requires miniature seven-contact socket and may be mounted in any position. Outline 5C, **Outlines** section.

The triode unit of the 6AV6 is recommended for use only in resistance-coupled circuits. Refer to the **Resistance-Coupled Amplifier** section for typical operating conditions.

**Grid bias** for the triode unit of the 6AV6 may be obtained from a fixed source, such as a fixed-voltage tap on the dc power supply, or from a cathode-bias resistor. It should not be obtained by the diode-biasing method because of the probability of plate-current cutoff, even with relatively small signal voltages applied to the diode circuit.

AVERAGE DIODE CHARACTERISTICS  
HALF-WAVE RECTIFICATION-SINGLE DIODE UNIT

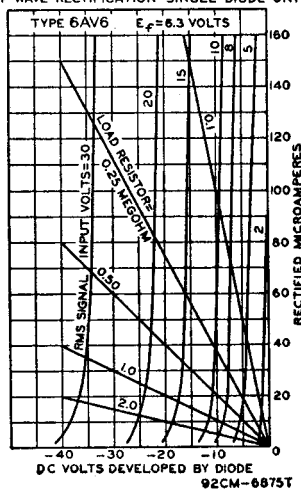

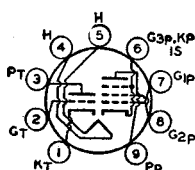
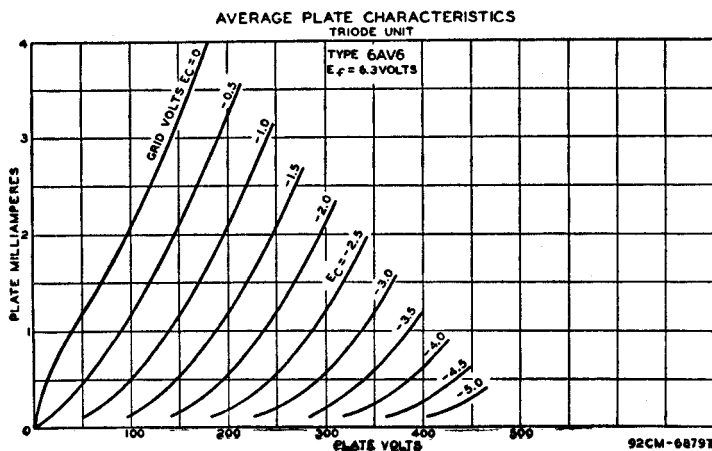

**9DX**

**HIGH-MU TRIODE—  
SHARP-CUTOFF PENTODE**

Miniature type used in a wide variety of applications in television receivers. This type has a controlled heater warm-up time for use in receivers employing series-connected heater strings. The pentode unit is used as an if amplifier, video amplifier, agc amplifier, or reactance tube. The triode unit is used in low-frequency oscillator, sync-separator, sync-clipper, and phase-splitter circuits. Outline 6E, **Outlines** section. This type requires miniature nine-contact socket and may be mounted in any position. Type 8AW8A is identical with type 6AW8A except for heater ratings, as shown below.

**6AW8A**

Related type:  
8AW8A

Heater Voltage (ac/dc)	6.3	8.4	volts
Heater Current	0.6	0.45	ampere
Heater Warm-up Time (Average)	11	11	seconds
Peak Heater-Cathode Voltage:			
Heater negative with respect to cathode		200 max	volts
Heater positive with respect to cathode		200* max	volts
Direct Interelectrode Capacitances:			
Triode Unit:			
Grid to Plate	2.2	2.2	pF
Grid to Cathode, Pentode Cathode, Pentode Grid No.3, Internal Shield, and Heater	3.2	3.4	pF
Grid to Cathode, Pentode Cathode, Pentode Grid No.3, Internal Shield, and Heater	1.8	3.0	pF
Pentode Unit:			
Grid No.1 to Plate	0.06 max	0.05 max	pF
Grid No.1 to Cathode, Heater, Grid No.2, Grid No.3, and Internal Shield	10	10	pF
Plate to Cathode, Heater, Grid No.2, Grid No.3, and Internal Shield	3.6	4.5	pF
Pentode Grid No.1 to Triode Plate	0.008 max	0.005 max	pF
Pentode Plate to Triode Plate	0.15 max	0.025 max	pF

\* The dc component must not exceed 100 volts.  
 \* With external shield connected to pins 4 and 5.

AVERAGE CHARACTERISTICS  
TRIODE UNIT

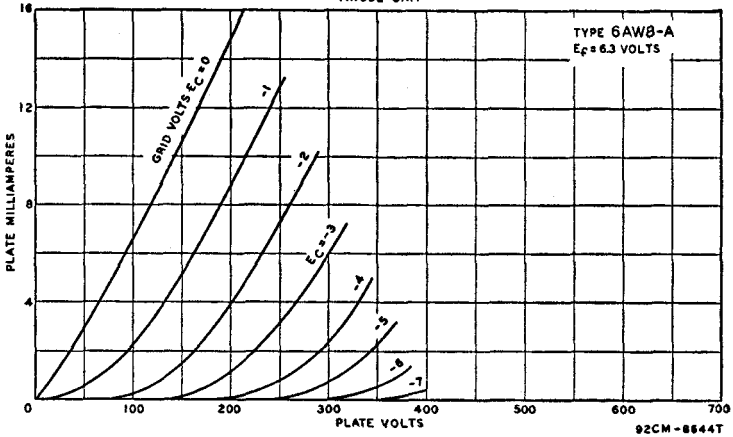

Class A<sub>1</sub> Amplifier

MAXIMUM RATINGS (Design-Maximum Values):

	Triode Unit	Pentode Unit	
Plate Voltage	330 max	330 max	volts
Grid-No.2 (Screen-Grid) Supply Voltage	—	330 max	volts
Grid-No.2 Voltage	—	See curve page 80	
Grid-No.1 (Control-Grid) Voltage:			
Positive bias value	0 max	0 max	volts
Plate Dissipation	1.1 max	3.75 max	watts
Grid-No.2 Input:			
For grid-No.2 voltages up to 165 volts	—	1.1 max	watts
For grid-No.2 voltages between 165 and 330 volts	—	See curve page 80	

AVERAGE CHARACTERISTICS  
PENTODE UNIT

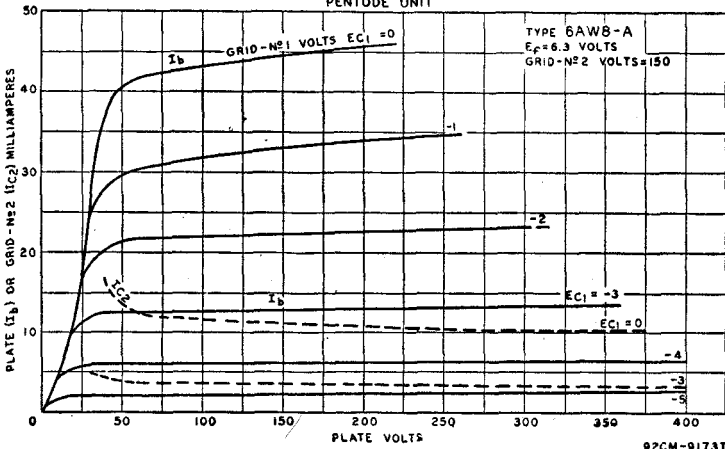

CHARACTERISTICS:

Plate Supply Voltage	200	150	volts
Grid-No.2 Supply Voltage	—	150	volts
Grid-No.1 Voltage	-2	—	volts
Cathode-Bias Resistor	—	150	ohms
Amplification Factor	70	—	

	<b>Triode Unit</b>	<b>Pentode Unit</b>	
Plate Resistance (Approx.) .....	—	0.2	megohm
Transconductance .....	4000	9500	$\mu$ mhos
Grid-No.1 Voltage (Approx.) for plate current of 20 $\mu$ A .....	—5	—8	volts
Plate Current .....	4	15	mA
Grid-No.2 Current .....	—	3.5	mA

**MAXIMUM CIRCUIT VALUES:**

**Grid-No.1-Circuit Resistance:**

For fixed-bias operation .....	0.5 max	0.25 max megohm
For cathode-bias operation .....	1.0 max	1.0 max megohm

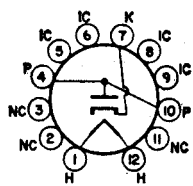

**12BL**

**HALF-WAVE VACUUM RECTIFIER**

Duodecar type used as damper tube in horizontal-deflection circuits of television receivers. Outline 8C, **Outlines** section. Tube requires 12-contact socket and may be mounted in any position. Socket terminals 5, 6, 8, and

**6AX3**

**Related types:**  
12AX3, 17AX3

9 should not be used as tie points. It is especially important that this tube, like other power-handling tubes, be adequately ventilated. Types 12AX3 and 17AX3 are identical with type 6AX3 except for heater ratings, as shown below.

	<b>6AX3</b>	<b>12AX3</b>	<b>17AX3</b>	
Heater Voltage (ac/dc) .....	6.3	12.6	16.8	volts
Heater Current .....	1.2	0.6	0.45	amperes
Heater Warm-up Time (Average) .....	—	11	11	seconds

**Damper Service**

For operation in a 525-line, 30-frame system

**MAXIMUM RATINGS (Design-Maximum Values):**

Peak Inverse Plate Voltage* .....	5000 max	volts
Peak Plate Current .....	1000 max	mA
DC Plate Current .....	165 max	mA
Plate Dissipation .....	5.3 max	watts
Peak Heater-Cathode Voltage:		
Heater negative with respect to cathode .....	5000*max	volts
Heater positive with respect to cathode .....	3000*max	volts

**CHARACTERISTICS, Instantaneous Value:**

Tube Voltage Drop for plate current of 250 mA .....	32	volts
---	----	-------

\* The duration of the voltage pulse must not exceed 15 per cent of one horizontal scanning cycle. In a 525-line, 30-frame system, 15 per cent of one horizontal scanning cycle is 10 microseconds.

- The dc component must not exceed 900 volts.
- The dc component must not exceed 100 volts.

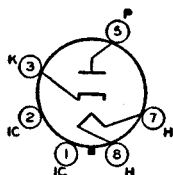

**4CG**

**HALF-WAVE VACUUM RECTIFIER**

Glass octal type used as damper tube in horizontal deflection circuits of television receivers. Outline 13D, **Outlines** section. May be supplied with pin No.1 omitted. This type requires octal socket and may be operated in

**6AX4GTB**

**Related types:**  
12AX4GTB, 17AX4GTA,  
25AX4GT

any position. Socket terminals 1, 2, 4, and 6 should not be used as tie points. It is especially important that this tube, like other power-handling tubes, be adequately ventilated. Types 12AX4GTB, 17AX4GTA, and 25AX4GT are identical with type 6AX4GTB except for heater ratings, as shown below.

	6AX4- GTB	12AX4- GTB	17AX4- GTA	25AX4GT	
Heater Voltage (ac/dc) .....	6.3	12.6	16.8	25	volts
Heater Current .....	1.2	0.6	0.45	0.3	amperes
Heater Warm-up Time (Average) .....	—	11	11	—	seconds
Direct Interelectrode Capacitances (Approx.):					
Cathode to Plate and Heater .....				8.5	pF
Plate to Cathode and Heater .....				5	pF
Heater to Cathode .....				4	pF

### Damper Service

For operation in a 525-line, 30-frame system

#### MAXIMUM RATINGS (Design-Maximum Values):

Peak Inverse Plate Voltage*	5000 max	volts
Peak Plate Current	1000 max	mA
DC Plate Current	165 max	mA
Plate Dissipation	5.3 max	watts
Peak Heater-Cathode Voltage:		
Heater negative with respect to cathode	5000*max	volts
Heater positive with respect to cathode	3000max	volts

#### CHARACTERISTICS, Instantaneous Test Condition:

Tube Voltage Drop for plate current of 250 mA ..... 32 volts

\* The duration of the voltage pulse must not exceed 15 per cent of one horizontal scanning cycle. In a 525-line, 30-frame system, 15 per cent of one horizontal scanning cycle is 10 microseconds.

• The dc component must not exceed 900 volts.

□ The dc component must not exceed 100 volts.

### FULL-WAVE VACUUM RECTIFIER

## 6AX5GT

Glass octal type used in power supply of radio equipment having moderate dc requirements. Outline 13D, Outlines section. This type may be supplied with pin No.1 omitted. Tube requires octal socket and may be

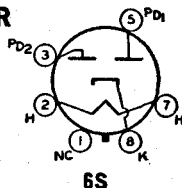

6S

mounted in any position. It is especially important that this tube, like other power-handling tubes, be adequately ventilated. Heater volts (ac), 6.3; amperes, 1.2.

### Full-Wave Rectifier

#### MAXIMUM RATINGS (Design-Center Values):

Peak Inverse Plate Voltage	1250 max	volts
Peak Plate Current (Per Plate)	375 max	mA
Hot-Switching Transient Plate Current:		
For duration of 0.2 second maximum	2.6 max	amperes
AC Plate Supply Voltage (Per Plate, rms)	See Rating Chart	
DC Output Current (Per Plate, rms)	See Rating Chart	
Peak Heater-Cathode Voltage:		
Heater negative with respect to cathode	450 max	volts
Heater positive with respect to cathode	450 max	volts

#### TYPICAL OPERATION WITH CAPACITOR INPUT TO FILTER:

AC Plate-to-Plate Supply Voltage (rms)	700	900	volts	
Filter Input Capacitor*	10	10	$\mu$ F	
Effective Plate-Supply Impedance Per Plate	50	105	ohms	
DC Output Voltage at Input to Filter (Approx.):				
At half-load current of	$\left\{ \begin{array}{l} 62.5 \text{ mA} \\ 40 \text{ mA} \\ 125 \text{ mA} \\ 80 \text{ mA} \end{array} \right.$	395	—	volts
At full-load current of		350	—	volts
		—	490	—
Voltage Regulation (Approx.):				
Half-load to full-load current	45	50	volts	



**TYPICAL OPERATION WITH CHOKE INPUT TO FILTER:**

AC Plate-to-Plate Supply Voltage (rms) .....	700	900	volts
Filter Input Choke .....	10#	10##	henries
DC Output Voltage at Input to Filter (Approx.):			
At half-load current of			
{ 150 mA .....	270		volts
{ 125 mA .....	—	365	volts
At full-load current of			
{ 75 mA .....	250		volts
{ 62.5 mA .....	—	350	volts
Voltage Regulation (Approx.):			
Half-load to full-load current .....	20	15	volts

\* Higher values of capacitance than indicated may be used but the effective plate-supply impedance may have to be increased to prevent exceeding the maximum rating for hot-switching transient plate current.

# This value is adequate to maintain optimum regulation provided the load current is not less than 30 mA. For load currents less than 30 mA, a larger value of inductance is required for optimum regulation.

## This value is adequate to maintain optimum regulation provided the load current is not less than 35 mA. For load currents less than 35 mA, a larger value of inductance is required for optimum regulation.

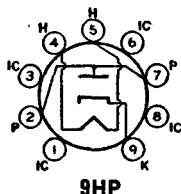
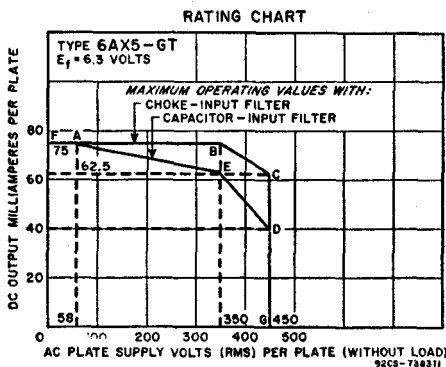

**HALF-WAVE VACUUM RECTIFIER**

Novar types used as damper tubes in horizontal deflection circuits of black-and-white television receivers. Outlines 11D and 30B, respectively, Outlines section. Tubes require novar socket and may be operated in any position.

**6AY3**  
**6AY3B**

**Related types:**  
12AY3, 12AY3A  
17AY3, 17AY3A

Socket terminals 1, 3, 6, and 8 should not be used as tie points. It is especially important that these tubes, like other power-handling tubes, be adequately ventilated. Types 12AY3 and 12AY3A and types 17AY3 and 17AY3A are identical with types 6AY3 and 6AY3B except for heater ratings, as shown below.

	6AY3	12AY3	17AY3	
	6AY3B	12AY3A	17AY3A	
Heater Voltage (ac/dc) .....	6.3	12.6	16.8	volts
Heater Current .....	1.2	0.6	0.45	amperes
Heater Warm-up Time (Average) .....	—	11	11	seconds
Direct Interelectrode Capacitances (Approx.):				
Plate to Cathode and Heater .....			6.5	pF
Cathode to Plate and Heater .....			9.0	pF
Heater to Cathode .....			2.8	pF

### Damper Service

For operation in a 525-line, 30-frame system

#### MAXIMUM RATINGS (Design-Maximum Values):

Peak Inverse Plate Voltage*	5000 max	volts
Peak Plate Current	1100 max	mA
DC Plate Current	175 max	mA
Plate Dissipation	6.5 max	watts
Peak Heater-Cathode Voltage:		
Heater negative with respect to cathode	5000*max	volts
Heater positive with respect to cathode	3000max	volts

\* The duration of the voltage pulse must not exceed 15 per cent of one horizontal scanning cycle. In a 525-line, 30-frame system, 15 per cent of one horizontal scanning cycle is 10 microseconds.

• The dc component must not exceed 900 volts.

□ The dc component must not exceed 100 volts.

### MEDIUM-MU TRIODE— SHARP-CUTOFF PENTODE

## 6AZ8

Miniature type used in a wide variety of applications in television receivers. The pentode unit is used as an if amplifier, video amplifier, agc amplifier, or reactance tube. The triode unit is used in low-frequency oscillator, sync-

separator, sync-clipper, and phase-splitter circuits. Outline 6B, **Outlines** section. Tube requires miniature nine-contact socket and may be mounted in any position.

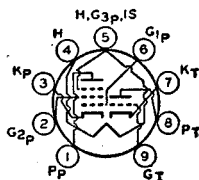

9ED

Heater Voltage (ac/dc)	6.3	volts
Heater Current	0.45	ampere
Peak Heater-Cathode Voltage:△		
Heater negative with respect to cathode	200 max	volts
Heater positive with respect to cathode	200*max	volts
Direct Interelectrode Capacitances:		
Triode Unit:		
Grid to Plate	1.7	pF
Grid to Cathode, Heater, Pentode Grid No.3, and Internal Shield	2	pF
Plate to Cathode, Heater, Pentode Grid No.3, and Internal Shield	1.7	pF
Pentode Unit:		
Grid No.1 to Plate	0.02 max	pF
Grid No.1 to Cathode, Heater, Grid No.2, Grid No.3, and Internal Shield	6.5	pF
Plate to Cathode, Heater, Grid No.2, Grid No.3, and Internal Shield	2.2	pF
Triode Grid to Pentode Plate	0.027 max	pF
Pentode Grid No.1 to Triode Plate	0.020 max	pF
Pentode Plate to Triode Plate	0.045 max	pF

△ The heater-cathode voltage of the pentode unit should not exceed the value of the operating cathode bias. If the heater-cathode voltage exceeds the operating cathode bias value, grid No.3 will be made negative with respect to cathode, and thus possibly cause a change in tube characteristics.

• The dc component must not exceed 100 volts.

### Class A<sub>1</sub> Amplifier

#### MAXIMUM RATINGS (Design-Center Values):

	Triode Unit	Pentode Unit	
Plate Voltage	300 max	300 max	volts
Grid-No.2 (Screen-Grid) Supply Voltage	—	300 max	volts
Grid-No.2 Voltage		See curve page 80	
Grid-No.1 (Control-Grid) Voltage, Positive-bias value	0 max	0 max	volts
Plate Dissipation	2.6 max	2 max	watts
Grid-No.2 Input:			
For grid-No.2 voltages up to 150 volts	—	0.5 max	watt
For grid-No.2 voltages between 150 and 300 volts	—	See curve page 80	

#### CHARACTERISTICS:

Plate Supply Voltage	200	200	volts
Grid-No.2 Voltage	—	150	volts

Grid-No.1 Voltage .....	-6	—	volts
Cathode-Bias Resistor .....	—	180	ohms
Amplification Factor .....	19	—	
Plate Resistance (Approx.) .....	5750	30000	ohms
Transconductance .....	3300	6000	μmhos
Grid-No.1 Voltage (Approx.) for plate current of 10 μA .....	-19	—	volts
Grid-No.1 Voltage (Approx.) for transconductance of 100 μmhos .....	—	-12.5	volts
Plate Current .....	13	9.5	mA
Grid-No.2 Current .....	—	3	mA

**MAXIMUM CIRCUIT VALUES:**

Grid-No.1-Circuit Resistance:*			
For fixed-bias operation .....	0.5 max	0.25 max	megohm
For cathode-bias operation .....	1.0 max	1.0 max	megohm

\* If either unit is operating at maximum rated conditions, grid-No.1-circuit resistance for both units should not exceed the stated values.

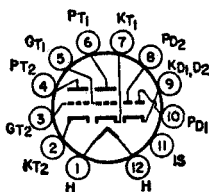

12BF

**TWIN DIODE—  
MEDIUM-MU TWIN TRIODE**

Duodecar type used in television receivers; diode units are used in horizontal-phase-detector circuits, and triode units are used in horizontal-oscillator circuits. Outline 8A, **Outlines** section. Tube requires duodecar

**6B10**

Related type:  
8B10

twelve-contact socket and may be mounted in any position. Type 8B10 is identical with type 6B10 except for heater ratings, as shown below.

Heater Voltage (ac/dc) .....	6B10	8B10	
Heater Current .....	6.3	8.5	volts
Heater Warm-up Time (Average) .....	0.6	0.45	ampere
Peak Heater-Cathode Voltage:	11	11	seconds
Heater negative with respect to cathode .....	200 max	200 max	volts
Heater positive with respect to cathode .....	200 <sup>o</sup> max	200 <sup>o</sup> max	volts

° The dc component must not exceed 100 volts.

**Class A<sub>1</sub> Amplifier (Each Triode Unit)**

**MAXIMUM RATINGS (Design-Maximum Value):**

Plate Voltage .....	330 max	volts
DC Cathode Current .....	20 max	mA
Plate Dissipation .....	3 max	watts

**CHARACTERISTICS:**

Plate Voltage .....	250	volts
Grid Voltage .....	-8	volts
Amplification Factor .....	18	
Plate Resistance (Approx.) .....	7200	ohms
Transconductance .....	2500	μmhos
Plate Current .....	10	mA
Grid Voltage (Approx.) for plate current of 50 μA .....	-20	volts

**MAXIMUM CIRCUIT VALUES:**

Grid-Circuit Resistance:		
For fixed-bias operation .....	0.25 max	megohm
For cathode-bias operation .....	1 max	megohm

**Diode Units (Each Unit)**

**MAXIMUM RATING (Design-Maximum Value):**

Plate Current .....	5 max	mA
---------------------	-------	----

**CHARACTERISTICS, Instantaneous Value:**

Tube Voltage Drop for plate current of 20 mA .....	5	volts
--	---	-------

## HALF-WAVE VACUUM RECTIFIER

### 6BA3

Novar type used as damper tube in horizontal-deflection circuits of television receivers. Outline 11B or 30C, **Outlines** section. Tube requires novar nine-contact socket and may be mounted in any position. Socket terminals

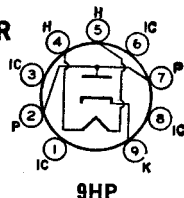

9HP

1, 3, 6, and 8 should not be used as tie points. It is especially important that this tube, like other power-handling tubes, be adequately ventilated.

Heater Voltage (ac/dc) .....	6.3	volts
Heater Current .....	1.2	amperes
Direct Interelectrode Capacitances, (Approx.):		
Plate to Cathode and Heater .....	4.4	pF
Cathode to Plate and Heater .....	6	pF
Heater to Cathode .....	1.8	pF

### Damper Service

For operation in a 525-line, 30-frame system

#### MAXIMUM RATINGS (Design-Maximum Values):

Peak Inverse Plate Voltage .....	5000*max	volts
Peak Plate Current .....	1000 max	mA
DC Plate Current .....	165 max	mA
Plate Dissipation .....	5.3 max	watts
Peak Heater-Cathode Voltage:		
Heater negative with respect to cathode .....	5000*max	volts
Heater positive with respect to cathode .....	300□max	volts

\* The duration of the voltage pulse must not exceed 15 per cent of one horizontal scanning cycle. In a 525-line, 30-frame system, 15 per cent of one horizontal scanning cycle is 10 microseconds.

- The dc component must not exceed 900 volts.
- The dc component must not exceed 100 volts.

## REMOTE-CUTOFF PENTODE

### 6BA6

Related types:  
3BA6, 12BA6

Miniature type used as rf amplifier in standard broadcast and FM receivers, as well as in wide-band, high-frequency applications. The low value of grid-No.1-to-plate capacitance minimizes regenerative effects, while the

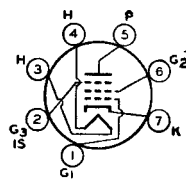

7BK

high transconductance makes possible high signal-to-noise ratio. Types 3BA6 and 12BA6 are identical with type 6BA6 except for heater ratings, as shown below.

	3BA6	6BA6	12BA6	
Heater Voltage (ac/dc) .....	3.15	6.3	12.6	volts
Heater Current .....	0.6	0.3	0.15	ampere
Heater Warm-up Time (Average) .....	11	—	—	seconds
Peak Heater-Cathode Voltage:				
Heater negative with respect to cathode ..	200 max	200 max	200 max	volts
Heater positive with respect to cathode ..	200□max	200□max	200□max	volts
Direct Interelectrode Capacitances:				
Grid No.1 to Plate .....			0.0035 max	pF
Grid No.1 to Cathode, Heater, Grid No.2, Grid No.3, and Internal Shield .....			5.5	pF
Plate to Cathode, Heater, Grid No.2, Grid No.3, and Internal Shield .....			5•	pF

▲ The dc component must not exceed 100 volts.

• This value is 5.5 pF with external shield connected to cathode.

**Class A<sub>1</sub> Amplifier**

**MAXIMUM RATINGS** (Design-Maximum Values):

Plate Voltage .....	330 max	volts
Grid-No.3 (Suppressor-Grid) Voltage, Positive value .....	0 max	volts
Grid-No.2 (Screen-Grid) Voltage .....	See curve page 80	
Grid-No.2 Supply Voltage .....	330 max	volts
Plate Dissipation .....	3.4 max	watts
Grid-No.2 Input:		
For grid-No.2 voltages up to 165 volts .....	0.7 max	watt
For grid-No.2 voltages between 165 and 330 volts .....	See curve page 80	
Grid-No.1 (Control-Grid) Voltage:		
Negative bias value .....	-55 max	volts
Positive bias value .....	0 max	volts

**CHARACTERISTICS:**

Plate Supply Voltage .....	100	250	volts
Grid No.3 and Internal Shield .....	Connected to cathode at socket		
Grid-No. 2 Supply Voltage .....	100	100	volts
Cathode-Bias Resistor .....	68	68	ohms
Plate Resistance (Approx.) .....	0.25	1.0	megohm
Transconductance .....	4300	4400	$\mu$ mhos
Grid-No.1 Voltage (Approx.) for transconductance of 40 $\mu$ mhos .....	-20	-20	volts
Plate Current .....	10.8	11	mA
Grid-No.2 Current .....	4.4	4.2	mA

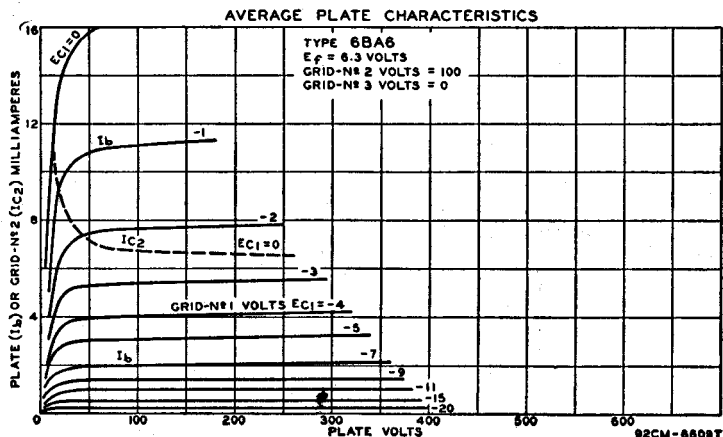

**Installation and Application**

Type 6BA6 requires miniature seven-contact socket and may be mounted in any position. Outline 5C, Outlines section.

**Control-grid bias** variation will be found effective in changing the volume of the receiver. In order to obtain adequate volume control, an available grid-No.1-bias voltage of approximately 50 volts will be required. The exact value will depend upon the circuit design and operating conditions. This voltage may be obtained, depending on the receiver requirements, from a potentiometer across a fixed supply voltage, from a variable cathode-bias resistor, from the avc system or from a combination of these methods.

The **grid-No.2 (screen-grid)** voltage may be obtained from a potentiometer or bleeder circuit across the B-supply source, or through a dropping resistor from the plate supply. The use of series resistors for obtaining satisfactory control of grid-No.2 voltage in the case of four-electrode tubes is usually impossible because of secondary-emission phenomena. In the 6BA6, however, because grid No.3 practically removes these effects, it is practical to obtain grid-No.2 voltage through a

series-dropping resistor from the plate supply or from some high intermediate voltage, provided the source does not exceed the plate-supply voltage. With this method, the grid-No.2-to-cathode voltage will fall off very little from minimum to maximum value of the resistor controlling cathode bias. In some cases, it may actually rise. This rise of grid-No.2-to-cathode voltage above the normal maximum value is allowable because both the grid-No.2 current and the plate current are reduced simultaneously by a sufficient amount to prevent damage to the tube. It should be recognized that, in general, the series-resistor method of obtaining grid-No.2 voltage from a higher voltage supply necessitates the use of the variable cathode-resistor method of controlling volume in order to prevent too high a voltage on grid No.2. When grid-No.2 and control-grid voltage are obtained in this manner, the remote "cutoff" advantage of the 6BA6 can be fully realized. However, it should be noted that the use of a resistor in the grid-No.2 circuit will have an effect on the change in plate resistance with variation in grid-No.3 (suppressor-grid) voltage in case grid No.3 is utilized for control purposes.

**Grid No.3 (suppressor grid)** may be connected directly to the cathode or it may be made negative with respect to the cathode. For the latter condition, the grid-No.3 voltage may be obtained from a potentiometer or bleeder circuit, or from the avc system.

## PENTAGRID CONVERTER

# 6BA7

Miniature type used as converter in superheterodyne circuits especially those for the FM broadcast band. Outline 6E, **Outlines** section. Tube requires miniature nine-contact socket and may be mounted in any position.

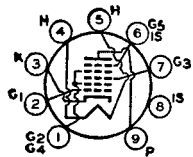

8CT

Heater volts (ac/dc), 6.3; amperes, 0.3; peak heater-cathode volts, 90.

### Converter Service

#### MAXIMUM RATINGS (Design-Center Values):

Plate Voltage	300 max	volts
Grid-No.5-and-Internal-Shield Voltage	0 max	volts
Grids-No.2-and-No.4 (Screen-Grid) Voltage	100 max	volts
Grids.-No.2-and-No.4 Supply Voltage	300 max	volts
Plate Dissipation	2.0 max	watts
Grids-No.2-and-No.4 Input	1.5 max	watts
Total Cathode Current	22 max	mA
Grid-No.3 Voltage:		
Negative bias value	-100 max	volts
Positive bias value	0 max	volts

#### CHARACTERISTICS (Separate Excitation):\*

Plate Voltage	100	250	volts
Grid No.5 and Internal Shield	Connected directly to ground		
Grids-No.2-and-No.4 (Screen-Grid) Voltage	100	100	volts
Grid-No.3 (Control-Grid) Voltage	-1.0	-1.0	volt
Grid-No.1 (Oscillator-Grid) Resistor	20000	20000	ohms
Plate Resistance (Approx.)	0.5	1.0	megohm
Conversion Transconductance	900	950	$\mu$ mhos
Conversion Transconductance (Approx.)**	3.5	3.5	$\mu$ mhos
Plate Current	3.6	3.8	mA
Grids-No.2-and-No.4 Current	10.2	10	mA
Grid-No.1 Current	0.35	0.35	mA
Total Cathode Current	14.2	14.2	mA

NOTE: The transconductance between grid No.1 and grids No.2 and No.4 connected to plate (not oscillating) is approximately 8000  $\mu$ mhos under the following conditions: signal applied to grid No.1 at zero bias; grids No.2 and No.4 and plate at 100 volts; grid No.3 grounded. Under the same conditions, the plate current is 32 milliamperes, and the amplification factor is 16.5.

\* The characteristics shown with separate excitation correspond very closely with those obtained in a self-excited oscillator circuit operating with zero bias.

\*\* With grid-No.3 bias of -20 volts.

▲ Internal Shield (pins No.6 and No.8) connected directly to ground.

### MEDIUM-MU TRIODE— SHARP-CUTOFF PENTODE

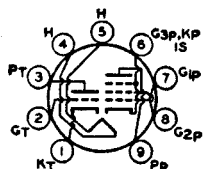

9DX

Miniature type used in a wide variety of applications in color and black-and-white television receivers. This type has a controlled heater warm-up time for use in receivers employing series-connected heater strings. The

pentode unit is used as a video amplifier, an agc amplifier, or a reactance tube. The triode unit is used in low-frequency oscillator and phase-splitter circuits. Outline 6E, **Outlines** section. Tube requires miniature nine-contact socket and may be mounted in any position. Type 8BA8A is identical with type 6BA8A except for the heater ratings, as shown below.

## 6BA8A

Related type:  
8BA8A

	<b>6BA8A</b>	<b>8BA8A</b>	
Heater Voltage (ac/dc) .....	6.3	8.4	volts
Heater Current .....	0.3	0.45	ampere
Heater Warm-up Time (Average) .....	11	—	seconds
Peak Heater-Cathode Voltage:			
Heater negative with respect to cathode .....	200 max	200 max	volts
Heater positive with respect to cathode .....	200° max	200° max	volts
Direct Interelectrode Capacitances (Approx.):	Without External Shield	With External Shield*	
Triode Unit:			
Grid to Plate .....	2.2	2.2	pF
Grid to Cathode and Heater .....	2.5	2.7	pF
Plate to Cathode and Heater .....	0.4	1.9	pF
Pentode Unit:			
Grid No.1 to Plate .....	0.06	0.05	pF
Grid No.1 to Cathode, Heater, Grid No.2, Grid No.3, and Internal Shield .....	10	10	pF
Plate to Cathode, Heater, Grid No.2, Grid No.3, and Internal Shield .....	3.6	4.5	pF
Triode Grid to Pentode Plate .....	0.016	0.006	pF
Pentode Grid No.1 to Triode Plate .....	0.006	0.003	pF
Pentode Plate to Triode Plate .....	0.15	0.023	pF

\* The dc component must not exceed 100 volts.

■ With external shield connected to cathode of unit under test.

### Class A<sub>1</sub> Amplifier

#### MAXIMUM RATINGS (Design-Center Values):

	Triode Unit	Pentode Unit	
Plate Voltage .....	300 max	300 max	volts
Grid-No.2 (Screen-Grid) Supply Voltage .....	—	300 max	volts
Grid-No.2 Voltage .....	—	See curve page 80	
Grid-No.1 (Control-Grid) Voltage:			
Negative bias value .....	—	-50 max	volts
Positive bias value .....	—	0 max	volts
Plate Dissipation .....	2 max	3.25 max	watts
Grid-No.2 Input:	Triode Unit	Pentode Unit	
For grid-No.2 voltages up to 150 volts .....	—	1 max	watt
For grid-No.2 voltages between 150 and 300 volts .....	—	See curve page 80	

#### CHARACTERISTICS:

Plate-Supply Voltage .....	200	200	volts
Grid-No.2 Supply Voltage .....	—	150	volts
Grid-No.1 Voltage .....	-8	—	volts
Cathode-Bias Resistor .....	—	180	ohms





**Class A<sub>1</sub> Amplifier**

**MAXIMUM RATINGS (Design-Center Values):**

Plate Voltage .....	250 max	volts
Plate Dissipation .....	2.5 max	watts
Cathode Current .....	25 max	mA

**CHARACTERISTICS:**

Plate Supply Voltage .....	150	volts
Cathode-Bias Resistor .....	100	ohms
Amplification Factor .....	48	
Plate Resistance (Approx.) .....	4800	ohms
Transconductance .....	10000	μmhos
Grid Voltage (Approx.) for plate current of 10 μA .....	-10	volts
Plate Current .....	14.5	mA

**MAXIMUM CIRCUIT VALUES:**

Grid-Circuit Resistance:		
For fixed-bias operation .....	Not recommended	
For cathode-bias operation .....	0.5 max	megohm

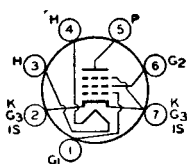

**7BD**

**SHARP-CUTOFF PENTODE**

Miniature type used in compact radio equipment as an rf or if amplifier at frequencies up to 400 megacycles per second. Outline 5C, **Outlines** section. Tube requires miniature seven-contact socket and may be mounted in any

**6BC5**

Related types:  
3BC5

position. For typical operation as resistance-coupled amplifier, refer to **Resistance-Coupled Amplifier** section. Type 3BC5 is identical with type 6BC5 except for heater ratings, as shown below.

	3BC5	6BC5	
Heater Voltage (ac/dc) .....	3.15	6.3	volts
Heater Current .....	0.6	0.3	ampere
Heater Warm-up Time (Average) .....	11	—	seconds
Peak Heater-Cathode Voltage:			
Heater negative with respect to cathode .....	200 max	90 max	volts
Heater positive with respect to cathode .....	200*max	90 max	volts
Direct Interelectrode Capacitances:			
Pentode Connection:			
Grid No.1 to Plate .....		0.030 max	pF
Grid No.1 to Cathode, Heater, Grid No.2, Grid No.3, and Internal Shield .....		6.5	pF
Plate to Cathode, Heater, Grid No.2, Grid No.3, and Internal Shield .....		1.8	pF
Triode Connection:*			
Grid No.1 to Plate and Grid No.2 .....		2.5	pF
Grid No.1 to Cathode, Heater, Grid No.3, and Internal Shield ..		3.9	pF
Plate and Grid No.2 to Cathode, Heater, Grid No.3, and Internal Shield .....		3.0	pF

- The dc component must not exceed 100 volts.
- Grid No.2 connected to plate.

**Class A<sub>1</sub> Amplifier**

**MAXIMUM RATINGS (Design-Center Values):**

	Triode Connection*	Pentode Connection	
Plate Voltage .....	300 max	300 max	volts
Grid-No.2 (Screen-Grid) Supply Voltage .....	—	300 max	volts
Grid-No.2 Voltage .....	—	See curve page 80	
Grid-No.1 (Control-Grid) Voltage, Positive-bias value ..	0 max	0 max	volts
Plate Dissipation .....	2.5 max	2 max	watts
Grid-No.2 Input:			
For grid-No.2 voltages up to 150 volts .....	—	0.5 max	watt
For grid-No.2 voltages between 150 and 300 volts ..	—	See curve page 80	

**CHARACTERISTICS:**

	Triode Connection*		Pentode Connection			
	180	250	100	125	250	
Plate Supply Voltage	180	250	100	125	250	volts
Grid-No.2 Supply Voltage	—	—	100	125	150	volts
Cathode-Bias Resistor	330	820	180	100	180	ohms
Amplification Factor	42	40	—	—	—	
Plate Resistance (Approx.)	0.006	0.009	0.6	0.5	0.8	megohm
Transconductance	6000	4400	4900	6100	5700	μmhos
Grid-No.1 Voltage (Approx.) for plate current of 10 μA	—	—	-5	-6	-8	volts
Plate Current	8	6	4.7	8	7.5	mA
Grid-No.2 Current	—	—	1.4	2.4	2.1	mA

\* Grid No.2 connected to plate.

**TRIPLE DIODE****6BC7**

Miniature type containing three high-perveance diode units in one envelope; used in dc restorer circuits of color television receivers. Also used in AM/FM radio receivers as a combination FM discriminator and AM

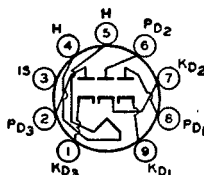
**SAX**

detector tube. Outline 6B, **Outlines** section. Tube requires nine-contact miniature socket and may be mounted in any position.

Heater Voltage (ac/dc)	6.3	volts
Heater Current	0.450	ampere
Peak Heater-Cathode Voltage:		
Heater negative with respect to cathode	200 max	volts
Heater positive with respect to cathode	200 max	volts
Direct Interelectrode Capacitances (Approx.):		
Diode-No.1 Plate to Diode-No.1 Cathode, Heater, and Internal Shield	3.5	pF
Diode-No.2 Plate to Diode-No.2 Cathode, Heater, and Internal Shield	5.5	pF
Diode-No.3 Plate to Diode-No.3 Cathode, Heater, and Internal Shield	3.5	pF

**MAXIMUM RATINGS (Design-Center Values, Each Diode Unit):**

Peak Inverse Plate Voltage	330 max	volts
Peak Plate Current*	54 max	mA
DC Output Current	12 max	mA

\* In rectifier service, the minimum total effective plate-supply impedance per plate is 560 ohms.

**MEDIUM-MU TWIN TRIODE****6BC8**

Related type:  
4BC8

Miniature type used in direct-coupled cathode-drive rf amplifier circuits of vhf television tuners. In such circuits, one triode unit is used as the direct-coupled grounded-cathode driver for the other unit. This type is also used

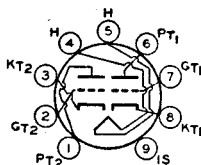
**SAJ**

in push-pull cathode-drive rf amplifiers. Outline 6B, **Outlines** section. Tube requires miniature nine-contact socket and may be mounted in any position. Type 4BC8 is identical with type 6BC8 except for heater ratings, as shown below.

	4BC8	6BC8	
Heater Voltage (ac/dc)	4.2	6.3	volts
Heater Current	0.6	0.4	ampere
Heater Warm-up Time (Average)	11	—	seconds
Peak Heater-Cathode Voltage:			
Heater negative with respect to cathode	200*max	200*max	volts
Heater positive with respect to cathode	200*max	200*max	volts

Direct Interelectrode Capacitances\*:

	Unit No.1	Unit No.2	
Grid to Plate .....	1.2	1.2	pF
Grid to Cathode, Heater, and Internal Shield .....	2.6	—	pF
Cathode to Grid, Heater, and Internal Shield .....	—	5.5	pF
Plate to Cathode, Heater, and Internal Shield .....	1.3	—	pF
Plate to Grid, Heater, and Internal Shield .....	—	2.4	pF
Plate to Cathode .....	—	0.12	pF
Heater to Cathode .....	2.8	2.8	pF
Plate of Unit No.1 to Plate of Unit No.2 .....		0.02 max	pF
Plate of Unit No.2 to Plate and Grid of Unit No.1 .....		0.04 max	pF

\* This rating may be as high as 300 volts under cutoff conditions, when the tube is used as a cascode amplifier and the two units are connected in series.

• The dc component must not exceed 100 volts.

• With external shield connected to internal shield.

Class A<sub>1</sub> Amplifier (Each Unit)

MAXIMUM RATINGS (Design-Maximum Values):

Plate Voltage .....	250 max	volts
Plate Dissipation .....	2.2 max	watts
Cathode Current .....	22 max	mA

CHARACTERISTICS:

Plate Supply Voltage .....	150	volts
Cathode-Bias Resistor .....	220	ohms
Plate Resistance (Approx.) .....	5300	ohms
Amplification Factor .....	35	
Transconductance .....	6200	μmhos
Grid Voltage (Approx.) for transconductance of 50 μmhos .....	-13	volts
Plate Current .....	10	mA

MAXIMUM CIRCUIT VALUES:

Grid-Circuit Resistance .....	0.5 max	megohm
-------------------------------	---------	--------

\* This rating may be as high as 300 volts under cutoff conditions, when the tube is used as a cascode amplifier and the two units are connected in series.

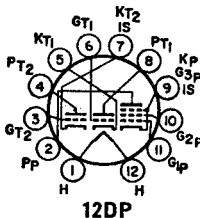

DUAL TRIODE—  
SHARP-CUTOFF PENTODE

Duodecar type used in a variety of applications in television receivers. The high-μ triode unit No.1 is used in general-purpose applications, the medium-μ triode unit No.2 in sync-separator circuits, and the pentode

6BD11

Related type:  
15BD11

unit as a video amplifier. Outline 8B, Outlines section. Tube requires duodecar twelve-contact socket and may be mounted in any position. Type 15BD11 is identical with type 6BD11 except for heater ratings, as shown below.

	6BD11	15BD11	
Heater Voltage (ac/dc) .....	6.3	14.7	volts
Heater Current .....	1.05	0.45	amperes
Heater Warm-up Time (Average) .....	—	11	seconds
Peak Heater-Cathode Voltage:			
Heater negative with respect to cathode .....	200 max	200 max	volts
Heater positive with respect to cathode .....	200•max	200•max	volts

• The dc component must not exceed 100 volts.

Class A<sub>1</sub> Amplifier

MAXIMUM RATINGS (Design-Maximum Values):

	Triode Unit No.1	Triode Unit No.2	Pentode Unit	
Plate Voltage .....	330 max	330 max	330 max	volts
Grid-No.2 (Screen-Grid) Supply Voltage .....	—	—	330 max	volts
Grid-No.2 Voltage .....	—	—	See curve page 80	
Grid-No.1 (Control-Grid) Voltage, Positive-bias value .....	0 max	0 max	0 max	volts
Plate Dissipation .....	1.5 max	2 max	4 max	watts
Grid-No.2 Input:				
For grid-No.2 voltages up to 165 volts .....	—	—	1.1 max	watts
For grid-No.2 voltages between 165 and 330 volts .....	—	—	See curve page 80	

CHARACTERISTICS:	Triode	Triode	Pentode Unit		
	Unit No.1	Unit No.2			
Plate Supply Voltage .....	200	200	35	135	volts
Grid-No.2 Supply Voltage .....	—	—	135	135	volts
Grid-No.1 Voltage .....	-2	—	0	0	volts
Cathode-Bias Resistor .....	—	220	—	100	ohms
Amplification Factor .....	68	41	—	—	
Plate Resistance (Approx.) .....	12400	9400	—	45000	ohms
Transconductance .....	5500	4400	—	10400	μmhos
Plate Current .....	7	9.2	34*	17	mA
Grid-No.2 Current .....	—	—	13*	4	mA
Grid-No.1 Voltage (Approx.) for plate current of 100 μA .....	-5.5	-6.5	—	-6	volts

**MAXIMUM CIRCUIT VALUES:**

Grid-No.1-Circuit Resistance:

For fixed-bias operation .....	0.5 max	0.5 max	1 max megohm
For cathode-bias operation .....	1 max	1 max	1 max megohm

\* This value may be measured by a method involving a recurrent waveform such that the maximum ratings of the tube will not be exceeded.

**HALF-WAVE VACUUM RECTIFIER****6BE3**

Related types:  
12BE3, 17BE3

Duodecar type used as damper tube in horizontal-deflection circuits of television receivers. Outline 8D, Outlines section. Tube requires duodecar twelve-contact socket and may be mounted in any position. Types

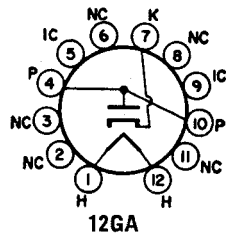

12BE3 and 17BE3 are identical with type 6BE3 except for the heater ratings, as shown below.

	6BE3	12BE3	17BE3	
Heater Voltage (ac/dc) .....	6.3	12.6	16.8	volts
Heater Current .....	1.2	0.6	0.45	ampere
Heater Warm-up Time (Average) .....	—	11	11	seconds

**Damper Service**

For operation in a 525-line, 30-frame system

**MAXIMUM RATINGS (Design-Maximum Values):**

Peak Inverse Plate Voltage# .....	5000 max	volts
Peak Plate Current .....	1200 max	mA
DC Plate Current .....	200 max	mA
Plate Dissipation .....	6.5 max	watts
Peak Heater-Cathode Voltage:		
Heater negative with respect to cathode .....	5000*max	volts
Heater positive with respect to cathode .....	300□max	volts

**CHARACTERISTICS, Instantaneous Value:**

Tube Voltage Drop for dc plate current of 350 mA .....

25 volts

# The duration of the voltage pulse must not exceed 15 per cent of one horizontal scanning cycle. In a 525-line, 30-frame system, 15 per cent of one horizontal scanning cycle is 10 microseconds.

\* The dc component must not exceed 900 volts.

□ The dc component must not exceed 100 volts.

**PENTAGRID CONVERTER****6BE6**

Related types:  
3BE6, 12BE6

Miniature type used as converter in superheterodyne circuits in both the standard broadcast and FM bands. The 6BE6 is similar in performance to metal type 6SA7. For general discussion of pentagrid types, see

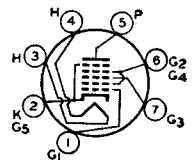

7CH

Frequency Conversion in Electron Tube Application section. Types 3BE6 and 12BE6 are identical with type 6BE6 except for the heater ratings, as shown below.

	3BE6	6BE6	12BE6	
Heater Voltage (ac/dc)	3.15	6.3	12.6	volts
Heater Current	0.6	0.3	0.15	ampere
Heater Warm-up time (Average)	11	—	—	seconds
Peak Heater-Cathode Voltage:				
Heater negative with respect to cathode	200 max	200 max	200 max	volts
Heater positive with respect to cathode	200 max	200 max	200 max	volts
		Without External Shield	With External Shield	
Direct Interelectrode Capacitances:				
Grid No.3 to Plate		0.30 max	0.25 max	pF
Grid No.3 to Grid No.1		0.15 max	0.15 max	pF
Grid No.1 to Plate		0.10 max	0.05 max	pF
Grid No.3 to All Other Electrodes		7.0	7.0	pF
Grid No.1 to All Other Electrodes		5.5	5.5	pF
Plate to All Other Electrodes		8.0	13.0	pF
Grid No.1 to Cathode and Grid No.5		3.0	3.0	pF
Cathode and Grid No.5 to All Other Electrodes except Grid No.1		15.0	20.0	pF

- ▲ The dc component must not exceed 100 volts.
- With external shield connected to cathode and grid No.5.

**Converter**

**MAXIMUM RATINGS (Design-Maximum Values):**

Plate Voltage		330 max	volts
Grids-No.2-and-No.4 (Screen-Grid) Voltage		110 max	volts
Grids-No.2-and-No.4 Supply Voltage		330 max	volts
Plate Dissipation		1.1 max	watts
Grids-No.2-and-No.4 Input		1.1 max	watts
Cathode Current		15.5 max	mA
Grid-No.3 Voltage:			
Negative bias value		-55 max	volts
Positive bias value		0 max	volts
Peak Heater-Cathode Voltage:			
Heater negative with respect to cathode		200 max	volts
Heater positive with respect to cathode		200 max	volts

**TYPICAL OPERATION (Separate Excitation):\***

Plate Voltage	100	250	volts
Grids-No.2-and-No.4 (Screen-Grid) Voltage	100	100	volts
Grid-No.1 (Oscillator-Grid) Voltage (rms)	10	10	volts
Grid-No.3 (Control-Grid) Voltage	-1.5	-1.5	volts
Grid-No.1 (Oscillator-Grid) Resistor	20000	20000	ohms
Plate Resistance (Approx.)	0.4	1.0	megohm
Conversion Transconductance	455	475	μmhos
Grid-No.3 Voltage for conversion transconductance of 10 μmhos	-30	-30	volts
Plate Current	2.6	2.9	mA
Grids-No.2-and-No.4 Current	7.0	6.8	mA
Grid-No.1 Current	0.5	0.5	mA
Cathode Current	10.1	10.2	mA

NOTE: The transconductance between grid No.1 and grids No.2 and No.4 connected to plate (not oscillating) is approximately 7250 μmhos under the following conditions: grids No.1 and No.3 at 0 volts; grids No.2 and No.4 and plate at 100 volts. Under the same conditions, the cathode current is 25 mA, and the amplification factor is 20. Grid-No.1 voltage (Approx.) for plate current of 10 μA is -11 volts.

\* The characteristics shown with separate excitation correspond very closely with those obtained in a self-excited oscillator circuit operating with zero bias.

**Installation and Application**

Type 6BE6 requires miniature seven-contact socket and may be mounted in any position. Outline 5C, Outlines section.

Because of the special structural arrangement of the 6BE6, a change in signal-grid voltage produces little change in cathode current. Consequently, an rf voltage on the signal grid produces little modulation of the electron current flowing in the cathode circuit. This feature is important because it is desirable that the impedance in the cathode circuit should produce little degeneration or regeneration of the signal-frequency input and intermediate-frequency output.

Another important feature is that, because signal-grid voltage has very little effect on the space charge near the cathode, changes in avc bias produce little change in oscillator transconductance and in the input capacitance of grid No.1. There is, therefore, little detuning of the oscillator by avc bias.

A typical self-excited oscillator circuit employing the 6BE6 is given in the **Circuit** section.

In the 6BE6 operation characteristics curves with self-excitation,  $E_k$  is the voltage across the oscillator-coil section between cathode and ground;  $E_g$  is the oscillator voltage between cathode and grid.

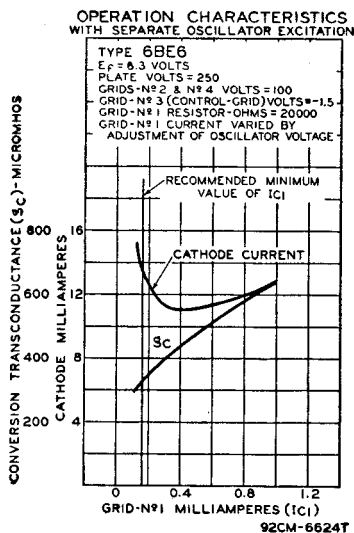
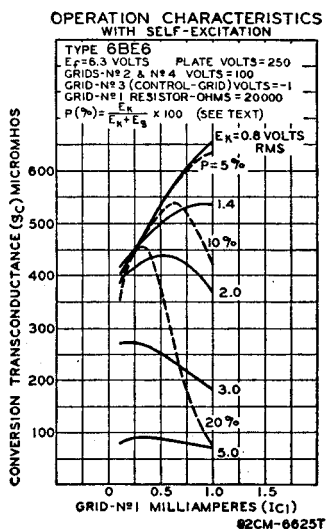

### BEAM POWER TUBE— SHARP-CUTOFF PENTODE

## 6BF11

Related type:  
17BF11

Duodec type used as combined detector and amplifier tube in television receivers. The dual-control, sharp-cutoff pentode unit is used as an FM detector and the beam power unit as an af output amplifier. Outline 8B,

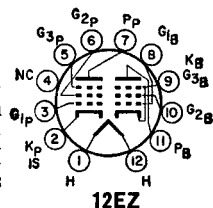

**Outlines** section. Tube requires duodec twelve-contact socket and may be mounted in any position. Type 17BF11 is identical with type 6BF11 except for heater ratings, as shown below.

	6BF11	17BF11	
Heater Voltage (ac/dc)	6.3	16.8	volts
Heater Current	—	0.45	amperes
Heater Warm-up Time (Average)	1.2	11	seconds
Peak Heater-Cathode Voltage:			
Heater negative with respect to cathode	200 max	200 max	volts
Heater positive with respect to cathode	200•max	200•max	volts

• The dc component must not exceed 100 volts.

**Beam Power Unit as Class A<sub>1</sub> Amplifier**

**MAXIMUM RATINGS (Design-Maximum Values):**

Plate Voltage	165 max	volts
Grid-No.2 (Screen-Grid) Voltage	150 max	volts
Plate Dissipation	6.5 max	watts
Grid-No.2 Input	1.8 max	watts
Average Cathode Current	65 max	mA

**TYPICAL OPERATION:**

Plate Voltage	145	volts
Grid-No.2 Voltage	110	volts
Grid-No.1 (Control-Grid) Voltage	-6	volts
Peak AF Grid-No.1 Voltage	6	volts
Zero-Signal Plate Current	36	mA
Maximum-Signal Plate Current	40	mA
Zero-Signal Grid No.2 Current	3	mA
Maximum-Signal Grid-No.2 Current	9	mA
Plate Resistance (Approx.)	0.03	megohm
Transconductance	8600	μmhos
Load Resistance	3000	ohms
Total Harmonic Distortion	10	per cent
Maximum-Signal Power Output	2.4	watts

**MAXIMUM CIRCUIT VALUES:**

Grid-No.1-Circuit Resistance:		
For fixed-bias operation	0.25 max	megohm
For cathode-bias operation	0.5 max	megohm

**Pentode Unit as Class A<sub>1</sub> Amplifier**

**CHARACTERISTICS:**

Plate Supply Voltage	150	volts
Grid-No.3 (Suppressor-Grid) Voltage	0	volts
Grid-No.2 (Screen-Grid) Supply Voltage	100	volts
Cathode-Bias Resistor	560	ohms
Plate Resistance (Approx.)	0.15	megohm
Transconductance, Grid No.1 to Plate	1000	μmhos
Transconductance, Grid No.3 to Plate	400	μmhos
Plate Current	1.1 max	watts
Grid-No.2 Current	1.3	mA
Grid-No.1 Voltage (Approx.) for plate current of 30 μA	2	mA
Grid-No.3 Voltage (Approx.) for plate current of 50 μA	See curve page 80	

**Pentode Unit as FM Detector**

**MAXIMUM RATINGS (Design-Maximum Values):**

Plate Voltage	330 max	volts
Grid-No.3 Voltage	28 max	volts
Grid No.2 Supply Voltage	330 max	volts
Grid-No.2 Voltage	See curve page 80	
Grid-No.1 (Control-Grid) Voltage, Positive-bias value	0 max	volts
Plate Dissipation	1.7 max	watts
Grid-No.2 Input:	-4.5	volts
For grid-No.2 voltages up to 165 volts		
For grid-No.2 voltages between 165 and 330 volts	-4.5	volts

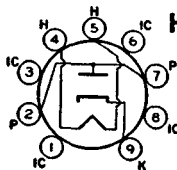

9HP

**HALF-WAVE VACUUM RECTIFIER**

Novar types used as damper tubes in horizontal deflection circuits of black-and-white television receivers. Outlines 11D and 30B, respectively, **Outlines** section. Tubes require novar socket and may be operated in any position.

**6BH3**  
**6BH3A**

Related types:  
17BH3, 17BH3A,  
22BH3, 22BH3A

Socket terminals 1, 3, 6, and 8 should not be used as tie points. It is especially important that these tubes, like other power-handling tubes, be adequately ventilated. Types 17BH3 and 17BH3A and types 22BH3 and 22BH3A are identical with types 6BH3 and 6BH3A except for the heater ratings, as shown below.

	6BH3 6BH3A	17BH3 17BH3A	22BH3 22BH3A	
Heater Voltage (ac/dc) .....	6.3	17	22.4	volts
Heater Current .....	1.6	0.6	0.45	amperes
Heater Warm-up Time (Average) .....	—	11	11	seconds
Direct Interelectrode Capacitances (Approx.):				
Plate to Cathode and Heater .....			6.5	pF
Cathode to Plate and Heater .....			9.0	pF
Heater to Cathode .....			2.8	pF

### Damper Service

For operation in a 525-line, 30-frame system

#### MAXIMUM RATINGS (Design-Maximum Values):

Peak Inverse Plate Voltage*	5500 max	volts
Peak Plate Current .....	1100 max	mA
DC Plate Current .....	180 max	mA
Plate Dissipation .....	6.5 max	watts
Peak Heater-Cathode Voltage:		
Heater negative with respect to cathode .....	5500 max	volts
Heater positive with respect to cathode .....	300 max	volts

\* The duration of the voltage pulse must not exceed 15 per cent of one horizontal scanning cycle. In a 525-line, 30-frame system, 15 per cent of one horizontal scanning cycle is 10 microseconds.

• The dc component must not exceed 900 volts.

□ The dc component must not exceed 100 volts.

### SHARP-CUTOFF PENTODE

Miniature type used as rf amplifier particularly in ac/dc receivers and in mobile equipment where low heater-current drain is important. It is particularly useful in high-frequency, wide-band applications. Outline 5C,

## 6BH6

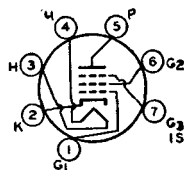

7CM

Outlines section. Tube requires miniature seven-contact socket and may be mounted in any position.

Heater Voltage (ac/dc) .....	6.3	volts
Heater Current .....	0.15	ampere
Peak Heater-Cathode Voltage:		
Heater negative with respect to cathode .....	90 max	volts
Heater positive with respect to cathode .....	90 max	volts
Direct Interelectrode Capacitances:*		
Grid No.1 to Plate .....	0.0035 max	pF
Grid No.1 to Cathode, Heater, Grid No.2, Grid No.3, and Internal Shield .....	5.4	pF
Plate to Cathode, Heater, Grid No.2, Grid No.3, and Internal Shield .....	4.4	pF

\* Without external shield, or with external shield connected to cathode.

### Class A<sub>1</sub> Amplifier

#### MAXIMUM RATINGS (Design-Center Values):

Plate Voltage .....	300 max	volts
Grid-No.2 (Screen-Grid) Voltage .....	See curve page 80	
Grid-No.2 Supply Voltage .....	300 max	volts
Plate Dissipation .....	3 max	watts
Grid-No.2 Input:		
For grid-No.2 voltages up to 150 volts .....	0.5 max	watt
For grid-No.2 voltages between 150 and 300 volts .....	See curve page 80	
Grid-No.1 (Control-Grid) Voltage:		
Negative-bias value .....	-50 max	volts
Positive-bias value .....	0 max	volts

#### CHARACTERISTICS:

Plate Voltage .....	100	250	volts
Grid No.3 .....	Connected to	cathode at	socket



Grid-No.2 Voltage .....	100	150	volts
Grid-No.1 Voltage .....	-1	-1	volt
Plate Resistance (Approx.) .....	0.7	1.4	megohms
Transconductance .....	3400	4600	$\mu$ mhos
Grid-No.1 Voltage (Approx.) for plate current of 10 $\mu$ A .....	-5	-7.7	volts
Plate Current .....	3.6	7.4	mA
Grid-No.2 Current .....	1.4	2.9	mA

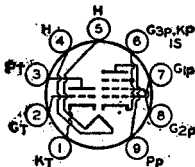

9DX

### MEDIUM-MU TRIODE— SHARP-CUTOFF PENTODE

Miniature type used in a wide variety of applications in television receivers. This type has a controlled heater warm-up time for use in receivers employing series-connected heater strings. The pentode unit is used as

## 6BH8

Related type:  
8BH8

an if amplifier, a video amplifier, or an agc amplifier. The triode unit is used in low-frequency oscillator circuits. Outline 6E, **Outlines** section. Tube requires miniature nine-contact socket and may be mounted in any position. Type 8BH8 is identical with type 6BH8 except for the heater ratings, as shown below.

	6BH8	8BH8	
Heater Voltage (ac/dc) .....	6.3	8.4	volts
Heater Current .....	0.6	0.45	ampere
Heater Warm-up Time (Average) .....	11	—	seconds
Peak Heater-Cathode Voltage:			
Heater negative with respect to cathode .....	200 max	200 max	volts
Heater positive with respect to cathode .....	200•max	200•max	volts
Direct Interelectrode Capacitances (Approx.):			
Triode Unit:			
Grid to Plate .....		2.4	pF
Grid to Cathode and Heater .....		2.6	pF
Plate to Cathode and Heater .....		0.38	pF
Pentode Unit:			
Grid No.1 to Plate .....		0.046	pF
Grid No.1 to Cathode, Heater, Grid No.2, Grid No.3, and Internal Shield .....		7	pF
Plate to Cathode, Heater, Grid No.2, Grid No.3, and Internal Shield .....		2.4	pF
Triode Grid to Pentode Plate .....		0.016	pF
Pentode Grid No.1 to Triode Plate .....		0.004	pF
Pentode Plate to Triode Plate .....		0.095	pF

\* The dc component must not exceed 100 volts.

### Class A<sub>1</sub> Amplifier

#### MAXIMUM RATINGS (Design-Center Values):

	Triode Unit	Pentode Unit	
Plate Voltage .....	300 max	300 max	volts
Grid-No.2 (Screen-Grid) Supply Voltage .....	—	300 max	volts
Grid-No.2 Voltage .....	—	See curve page 80	
Grid-No.1 (Control-Grid) Voltage, Positive-bias value ..	0 max	0 max	volts
Plate Dissipation .....	2.5 max	3 max	watts
Grid-No.2 Input:			
For grid-No.2 voltages up to 150 volts .....	—	1 max	watt
For grid-No.2 voltages between 150 and 300 volts .....	—	See curve page 80	

#### CHARACTERISTICS:

Plate Supply Voltage .....	150	200	volts
Grid-No.2 Supply Voltage .....	—	125	volts
Grid-No.1 Voltage .....	-5	—	volts
Cathode-Bias Resistor .....	—	82	ohms
Amplification Factor .....	17	—	

Plate Resistance (Approx.) .....	5150	150000	ohms
Transconductance .....	3300	7000	μmhos
Grid-No.1 Voltage (Approx.) for plate current of 100 μA .....	-14	-8	volts
Plate Current .....	9.5	15	mA
Grid-No.2 Current .....	—	3.4	mA

**MAXIMUM CIRCUIT VALUES:**

Grid-No.1-Circuit Resistance:			
For fixed-bias operation .....	0.5 max	0.25 max	megohm
For cathode-bias operation .....	1.0 max	1.0 max	megohm

**MEDIUM-MU TWIN TRIODE—  
SHARP-CUTOFF PENTODE**

**6BH11**

Duodecar type used in television receivers. The triode units are used for general-purpose applications, and the pentode unit is used for horizontal-deflection service. Outline 8B, Outlines section. Tube requires duodecar

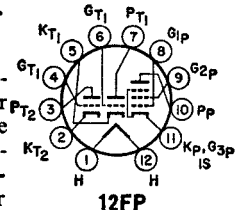

12FP

twelve-contact socket and may be mounted in any position. Heater volts (ac/dc), 6.3; amperes, 0.8; peak heater-cathode volts, 200 (the dc component must not exceed 100 volts when the heater is positive with respect to the cathode).

**Pentode Unit As Horizontal-Oscillator**

**MAXIMUM RATINGS (Design-Maximum Values):**

Plate Voltage .....	350 max	volts
Grid-No.2 (Screen-Grid) Voltage .....	330 max	volts
Grid-No.1 (Control-Grid) Voltage:		
Positive-bias value .....	0 max	volts
Peak negative value .....	-175 max	volts
Peak Cathode Current .....	300 max	mA
Average Cathode Current .....	20 max	mA
Plate Dissipation .....	2.5 max	watts
Grid-No. 2 Input .....	0.55 max	watt

**Class A<sub>1</sub> Amplifier**

**MAXIMUM RATINGS (Design-Maximum Values):**

Plate Voltage .....	330 max	volts
Grid Voltage, Positive-bias Value .....	0 max	volts
Plate Dissipation .....	2.5 max	watts

Each Triode Unit

**CHARACTERISTICS:**

	Pentode Unit	Each Triode Unit	
Plate Voltage .....	125	125	volts
Grid-No.2 Voltage .....	125	—	volts
Grid-No.1 Voltage .....	-1	-1	volt
Amplification Factor .....	—	46	
Plate Resistance (Approx.) .....	200000	5400	ohms
Transconductance .....	7500	8500	μmhos
Plate Current .....	12	13.5	mA
Grid-No.2 Current .....	4	—	mA
Grid-No.1 Voltage (Approx.) for plate current of 10 μA .....	-8	-8	volts

**MAXIMUM CIRCUIT VALUES:**

Grid-Circuit Resistance:		
For fixed-bias operation .....	2.2 max	megohms
For cathode-bias operation .....	2.2 max	megohms

**MAXIMUM CIRCUIT VALUES:**

Grid-No. 1-Circuit Resistance:		
For fixed-bias operation .....	2.2 max	megohms
For cathode-bias operation .....	2.2 max	megohms

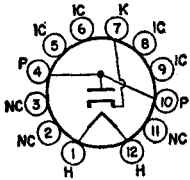

12BL

### HALF-WAVE VACUUM RECTIFIER

Duodecar type used as damper tube in horizontal-deflection circuits of television receivers. Outline 8C, **Outlines** section. Tube requires duodecar twelve-contact socket and may be mounted in any position. Socket terminals 5, 6, 8, and 9 should not be used as tie points. It is especially important that this tube, like other power-handling tubes, be adequately ventilated. Heater volts (ac/dc), 6.3; amperes, 1.2.

**6BJ3**

#### Damper Service

For operation in a 525-line, 30-frame system

#### MAXIMUM RATINGS (Design-Maximum Values):

Peak Inverse Plate Voltage#	3300 max	volts
Peak Plate Current	840 max	mA
DC Plate Current	140 max	mA
Plate Dissipation	4 max	watts
Peak Heater-Cathode Volts:		
Heater negative with respect to cathode	3300*max	volts
Heater positive with respect to cathode	300*max	volts

#### CHARACTERISTICS, Instantaneous Value:

Tube Voltage Drop for plate current of 250 mA	21	volts
---	----	-------

# The duration of the voltage pulse must not exceed 15 per cent of one horizontal scanning cycle. In a 525-line, 30-frame system, 15 per cent of one horizontal scanning cycle is 10 microseconds.

- ▲ The dc component must not exceed 600 volts.
- The dc component must not exceed 100 volts.

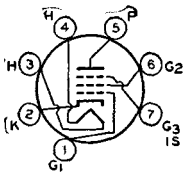

7CM

### REMOTE-CUTOFF PENTODE

Miniature type used as rf amplifier in high-frequency and wide-band applications. Features high transconductance and low grid-to-plate capacitance. Outline 5C, **Outlines** section. Tube requires miniature seven-contact socket and may be mounted in any position.

**6BJ6**

Heater Voltage (ac/dc)	6.3	volts
Heater Current	0.15	ampere
Peak Heater-Cathode Voltage:		
Heater negative with respect to cathode	90 max	volts
Heater positive with respect to cathode	90 max	volts
Direct Interelectrode Capacitances:*		
Grid No.1 to Plate	0.0035 max	pF
Grid No.1 to Cathode, Heater, Grid No.2, Grid No.3, and Internal Shield	4.5	pF
Plate to Cathode, Heater, Grid No.2, Grid No.3, and Internal Shield	5.5	pF

\* Without external shield, or with external shield connected to cathode.

#### Class A<sub>1</sub> Amplifier

#### MAXIMUM RATINGS (Design-Center Values):

Plate Voltage	300 max	volts
Grid-No.2 (Screen-Grid) Voltage	See curve page 80	
Grid-No.2 Supply Voltage	300 max	volts
Plate Dissipation	3 max	watts
Grid-No.2 Input:		
For grid-No.2 voltages up to 150 volts	0.6 max	watt
For grid-No.2 voltages between 150 and 300 volts	See curve page 80	

## Grid-No.1 (Control-Grid) Voltage:

Negative bias value .....	-50 max	volts
Positive bias value .....	0 max	volts

**CHARACTERISTICS:**

Plate Voltage .....	100	250	volts
Grid No.3 .....		Connected to cathode at socket	
Grid-No.2 Voltage .....	100	100	volts
Grid-No.1 Voltage .....	-1.0	-1.0	volt
Plate Resistance (Approx.) .....	0.25	1.3	megohms
Transconductance .....	3650	3600	$\mu$ mhos
Grid-No.1 Voltage (Approx.) for transconductance of 10 $\mu$ mhos .....	-20	-20	volts
Plate Current .....	9.0	9.2	mA
Grid-No.2 Current .....	3.5	3.3	mA

**TRIPLE DIODE****6BJ7**

Miniature type used as a dc-restorer tube in each of the three signal channels of color-television receivers. Each diode has a separate cathode. Outline 6B, **Outlines** section. Tube requires miniature nine-contact socket

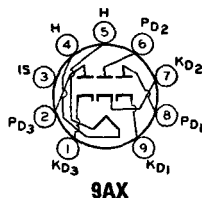

and may be mounted in any position. Heater volts, 6.3; amperes, 0.45.

**DC Restorer Service****MAXIMUM RATINGS** (Design-Center Values, Each Diode Unit):

Peak Inverse Plate Voltage .....	330 max	volts
Peak Plate Current .....	10 max	mA
DC Output Current .....	1 max	mA
Peak Heater-Cathode Voltage:		
Heater negative with respect to cathode .....	330 max	volts
Heater positive with respect to cathode .....	100 max	volts

**TWIN DIODE—  
MEDIUM-MU TRIODE****6BJ8**

Miniature type used in a wide variety of applications in black-and-white and color television receivers. The diode units are used in phase-detector, phase-comparator, ratio-detector or discriminator, and horizontal afc discriminator circuits. The triode unit is used in phase-splitter, audio-frequency amplifier, and low-frequency oscillator applications; it may also be used as a vertical-deflection amplifier in compact portable television receivers. This type has a controlled heater warm-up time for use in receivers employing series-connected heater strings. Each of the three units has its own cathode with individual base-pin terminal to provide for flexibility of circuit connections. Outline 6E, **Outlines** section. Tube requires miniature nine-contact socket and may be mounted

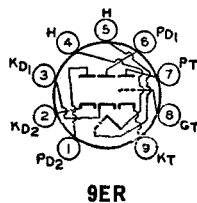

in any position.

Heater Volts (ac/dc) .....	6.3	volts
Heater Current .....	0.6	ampere
Heater Warm-up Time (Average) .....	11	seconds
Peak Heater-Cathode Voltage:		
Heater negative with respect to cathode .....	200 max	volts
Heater positive with respect to cathode .....	200 max	volts

Direct Interelectrode Capacitances:

Triode Unit:		
Grid to Plate .....	2.6	pF
Grid to Cathode and Heater .....	2.8	pF
Plate to Cathode and Heater .....	0.31	pF
Diode Units:		
Plate to Cathode and Heater (Each Unit) .....	1.9	pF
Cathode to Plate and Heater (Each Unit) .....	4.6	pF
Plate of Unit No.1 to Plate of Unit No.2 .....	0.06 max	pF
Plate of Diode Unit No.1 to Triode Grid .....	0.07 max	pF
Plate of Diode Unit No.2 to Triode Grid .....	0.11 max	pF
Plate of Either Diode Unit to All Other Electrodes .....	3.0	pF
Cathode of Either Diode Unit to All Other Electrodes .....	4.8	pF

• The dc component must not exceed 100 volts.

Triode Unit As Class A<sub>1</sub> Amplifier

MAXIMUM RATINGS (Design-Maximum Values):

Plate Voltage .....	330 max	volts
Grid Voltage, Positive-bias value .....	0 max	volts
Average Cathode Current .....	22 max	mA
Plate Dissipation .....	4 max	watts

CHARACTERISTICS:

Plate Voltage .....	90	250	volts
Grid Voltage .....	0	-9	volts
Amplification Factor .....	22	20	
Plate Resistance (Approx.) .....	4700	7150	ohms
Transconductance .....	4700	2800	μmhos
Grid Voltage (Approx.) for plate current of 10 μA ..	-7	-18	volts
Plate Current .....	13.5	8	mA
Plate Current for grid voltage of -12.5 volts .....	--	1.7	mA

MAXIMUM CIRCUIT VALUE:

Grid-Circuit Resistance .....	1 max	megohm
-------------------------------	-------	--------

AVERAGE CHARACTERISTICS  
TRIODE UNIT

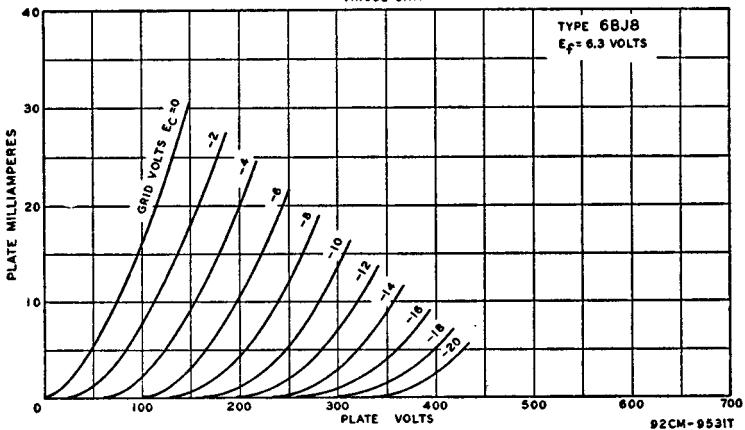

Triode Unit As Vertical Deflection Amplifier

For operation in a 525-line, 30-frame system

MAXIMUM RATINGS (Design-Maximum Values):

DC Plate Voltage .....	330 max	volts
Peak Positive-Pulse Plate Voltage† .....	1200 max	volts
Peak Negative-Pulse Grid Voltage .....	-275 max	volts
Peak Cathode Current .....	77 max	mA
Average Cathode Current .....	22 max	mA
Plate Dissipation .....	4 max	watts

**MAXIMUM CIRCUIT VALUE:**

Grid-Circuit Resistance:

For cathode-bias operation ..... 2.2 max megohms

† The duration of the voltage pulse must not exceed 15 per cent of one vertical scanning cycle. In a 525-line, 30-frame system, 15 per cent of one vertical scanning cycle is 2.5 milliseconds.

**Diode Units**

**MAXIMUM RATINGS (Design-Maximum Values):**

Plate Current (Each Unit):

Peak ..... 54 max mA  
Average ..... 9 max mA

**SHARP-CUTOFF  
BEAM TRIODE**

**6BK4A  
6BK4B**

Glass octal types used for the voltage regulation of high-voltage, low-current dc power supplies in color television receivers. Outline 21B, **Outlines** section. Tubes require octal socket and may be mounted in any position.

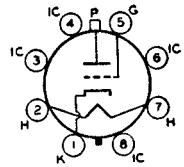

**8GC**

Type 6BK4B is identical with type 6BK4A except for a higher plate dissipation and peak heater-cathode voltage.

Heater Voltage (ac/dc) .....	6.3	volts
Heater Current .....	0.2	ampere
Peak Heater-Cathode Voltage:		
Heater negative with respect to cathode .....	200	450*max volts
Heater positive with respect to cathode .....	Not recommended	
Direct Interelectrode Capacitances (Approx.):		
Grid to Plate .....	0.03	pF
Grid to Cathode and Heater .....	2.6	pF
Plate to Cathode and Heater .....	1	pF
Amplification Factor (Approx.) .....	2000	

\* Series impedance should be used with the cathode to limit the cathode current under prolonged short-circuit conditions to 450 mA.

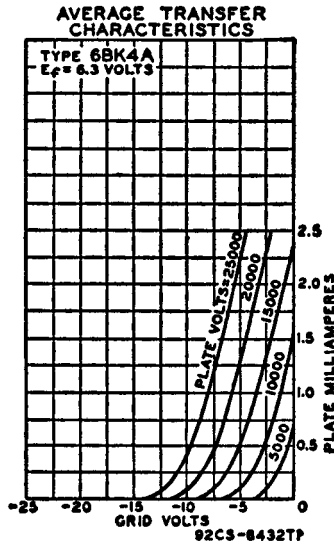

Voltage-Control Service

MAXIMUM RATINGS (Design-Maximum Values):

DC Plate Voltage .....	27000 max	volts
Unregulated DC Supply Voltage .....	60000 max	volts
DC Grid Voltage .....	-135 max	volts
Peak Grid Voltage* .....	-440 max	volts
DC Plate Current .....	1.6 max	mA
Plate Dissipation (6BK4A) .....	30 max	watts
Plate Dissipation (6BK4B) .....	40 max	watts

MAXIMUM CIRCUIT VALUE:

- Grid-Circuit Resistance:  
 For use with "Flyback Transformer" high-voltage supply ..... 3 max megohms
- \* For interval of 20 seconds maximum duration during equipment warm-up period.

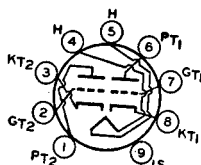

9AJ

MEDIUM-MU TWIN TRIODE

Miniature type used in direct-coupled cathode-drive rf amplifier circuits of vhf television tuners. In such circuits, one triode unit is used as the direct-coupled grounded-cathode driver for the other unit. This type is also used

6BK7B

Related type:  
5BK7A

in push-pull cathode-drive rf amplifiers. It has a controlled heater warm-up time for use in receivers employing series-connected heater strings. Outline 6B, **Outlines** section. Type requires miniature nine-contact socket and may be mounted in any position. For typical operation as a resistance-coupled amplifier, refer to **Resistance-Coupled Amplifier** section. Type 5BK7A is identical with type 6BK7B except for the heater ratings, as shown below.

	5BK7A	6BK7B	
Heater Voltage (ac/dc) .....	4.7	6.3	volts
Heater Current .....	0.6	0.45	ampere
Heater Warm-up Time (Average) .....	11	11	seconds
Peak Heater-Cathode Voltage:			
Heater negative with respect to cathode .....	200*	200*	volts
Heater positive with respect to cathode .....	200*	200*	volts
Direct Interelectrode Capacitances:	Unit No. 1	Unit No. 2	
Grid to Plate .....	1.8	1.8	pF
Grid to Cathode, Heater, and Internal Shield .....	3	3	pF
Plate to Cathode, Heater, and Internal Shield .....	1	0.9	pF
Cathode to Grid, Heater, and Internal Shield .....	6	6	pF
Plate to Grid, Heater, and Internal Shield .....	2.4	2.4	pF
Plate to Cathode .....	0.22	0.22	pF
Heater to Cathode .....	2.8	3	pF
Grid of Unit No.1 to Grid of Unit No.2 .....		0.004 max	pF
Plate of Unit No.1 to Plate of Unit No.2 .....		0.075 max	pF

\* In cathode-drive circuits with direct-coupled drive, it is permissible for this voltage to be as high as 300 volts under cutoff conditions.

▪ The dc component must not exceed 100 volts.

Class A<sub>1</sub> Amplifier (Each Unit)

MAXIMUM RATINGS (Design-Center Values):

Plate Voltage .....	300 max	volts
Grid Voltage, Negative-bias value .....	-50 max	volts
Plate Dissipation .....	2.7 max	watts

CHARACTERISTICS:

Plate Supply Voltage .....	150	volts
Cathode-Bias Resistor .....	56	ohms
Amplification Factor .....	43	
Plate Resistance (Approx.) .....	4600	ohms
Transconductance .....	9300	μmhos
Plate Current .....	18	mA
Grid Voltage (Approx.) for plate current of 10 μA .....	-11	volts

## MEDIUM-MU TWIN TRIODE

## 6BL7GTA

Glass octal type used as combined vertical deflection amplifier and vertical deflection oscillator in television receivers. When so operated, it is recommended that unit No.1 (pins 4, 5, and 6) be used as the oscillator.

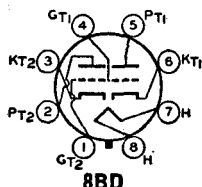

Outline 13D, **Outlines** section. This type requires octal socket and may be mounted in any position.

Heater Voltage (ac/dc) .....	6.3	volts
Heater Current .....	1.5	amperes
Peak Heater-Cathode Voltage:		
Heater negative with respect to cathode .....	200 max	volts
Heater positive with respect to cathode .....	200*max	volts
Direct Interelectrode Capacitances (Approx.):	Unit No. 1	Unit No. 2
Grid to Plate .....	6	6
Grid to Cathode and Heater .....	4.2	4.6
Plate to Cathode and Heater .....	0.9	0.9
Amplification Factor* .....		15
Plate Resistance (Approx.)* .....		2150
Transconductance* .....		7000

\* The dc component must not exceed 100 volts.

\* Each unit; for plate volts, 250; grid volts, -9; plate mA, 40.

## Vertical Deflection Oscillator Or Amplifier\*

For operation in a 525-line, 30-frame system

MAXIMUM RATINGS (Design-Center Values):	Oscillator	Amplifier	
DC Plate Voltage .....	500 max	500 max	volts
Peak Positive-Pulse Plate Voltage† (Absolute Maximum) .....	—	2000Δmax	volts
Peak Negative-Pulse Grid Voltage .....	-400 max	-250 max	volts
Peak Cathode Current .....	210 max	210 max	mA
Average Cathode Current .....	60 max	60 max	mA
Plate Dissipation:			
For either plate .....	10 max	10 max	watts
For both plates with both units operating .....	12 max	12 max	watts

## MAXIMUM CIRCUIT VALUES:

Grid-Circuit Resistance .....	4.7 max	4.7#max megohms
-------------------------------	---------	-----------------

\* Unless otherwise specified, values are for each unit.

† The duration of the voltage pulse must not exceed 15 per cent of one vertical scanning cycle. In a 525-line, 30-frame system, 15 per cent of one vertical scanning cycle is 2.5 milliseconds.

Δ Under no circumstances should this absolute value be exceeded.

# For cathode-bias operation.

## 6BL8

6BL8/  
ECF80

Related type:  
4BL8, 4BL8/CXF80

MEDIUM-MU TRIODE—  
SHARP-CUTOFF PENTODE

Miniature types used in frequency-changer service in television receivers. Outline 6B, **Outlines** section. Tubes require miniature nine-contact socket and may be mounted in any position.

Types 4BL8/CXF80 and 6BL8/

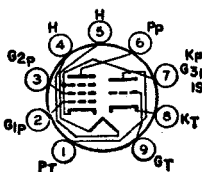

## 9DC

ECF80 are identical with types 4BL8 and 6BL8, respectively. Type 4BL8 is identical with type 6BL8 except for the heater ratings, as shown below.

Heater Voltage (ac/dc) .....	4BL8	6BL8	
Heater Current .....	4.6	6.3	volts
Peak Heater-Cathode Voltage:			ampere
Heater negative with respect to cathode .....	100 max	100 max	volts
Heater positive with respect to cathode .....	100 max	100 max	volts



**Class A<sub>1</sub> Amplifier**

<b>MAXIMUM RATINGS (Design-Center Values):</b>			
	Triode Unit	Pentode Unit	
Plate Supply Voltage	550 max	550 max	volts
Plate Voltage	250 max	250 max	volts
Grid-No.2 (Screen-Grid) Supply Voltage	—	550 max	volts
Grid-No.2 Voltage:			
With cathode current of 14 mA	—	175 max	volts
With cathode current less than 10 mA	—	200 max	volts
Cathode Current	14 max	14 max	mA
Grid-No.2 Input:			
With plate dissipation greater than 1.2 watts	—	0.5 max	watt
With plate dissipation less than 1.2 watts	—	0.75 max	watt
Plate Dissipation	1.5 max	1.7 max	watts

**CHARACTERISTICS:**

Plate Voltage	100	170	volts
Grid-No.2 Voltage	—	170	volts
Grid-No.1 Voltage	-2	-2	volts
Amplification Factor	20	—	
Mu-Factor, Grid No.2 to Grid No.1	—	47	
Plate Resistance (Approx.)	—	0.4	megohm
Transconductance	5000	6200	μmhos
Plate Current	14	10	mA
Grid-No.2 Current	—	2.8	mA
Input Resistance at frequency of 50 Mc/s	—	0.01	megohm
Equivalent Noise Resistance	—	1500	ohms

**MAXIMUM CIRCUIT VALUES:**

<b>Grid-No.1-Circuit Resistance:</b>			
For fixed-bias operation	0.5 max	0.5 max	megohm
For cathode-bias operation	0.5 max	1 max	megohm

**HIGH-MU TRIODE—  
POWER PENTODE**

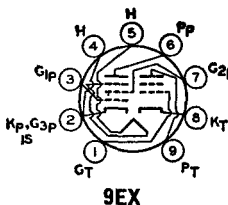

Miniature type used in television receivers. The pentode unit is used as an audio output tube, and the triode unit as an oscillator and af voltage amplifier. Outline 6G, **Outlines** section.

**6BM8/  
ECL82**

Tube requires miniature nine-contact socket and may be mounted in any position. Heater volts (ac/dc), 6.3; amperes, 0.78; peak heater-cathode volts, 100.

**Class A<sub>1</sub> Amplifier**

<b>MAXIMUM RATINGS (Design-Center Values):</b>			
	Triode Unit	Pentode Unit	
Plate Supply Voltage	550 max	900 max	volts
Plate Voltage	300 max	600 max	volts
Grid-No.2 Supply Voltage	—	550 max	volts
Grid-No.2 Voltage	—	300 max	volts
Cathode Current	15 max	50 max	mA
Plate Dissipation	1 max	7 max	watts
Grid-No.2 Input	—	1.8 max	watts

**CHARACTERISTICS:**

Plate Voltage	100	200	volts
Grid-No.2 Voltage	—	200	volts
Grid-No.1 Voltage	0	-16	volts
Amplification Factor	70	9.5*	
Plate Resistance (Approx.)	—	0.02	megohm
Transconductance	2500	6400	μmhos
Plate Current	3.5	35	mA
Grid-No.2 Current	—	7	mA

**MAXIMUM CIRCUIT VALUES:**

<b>Grid-No.1-Circuit Resistance:</b>			
For fixed-bias operation	1 max	1 max	megohm
For cathode-bias operation	2 max	2 max	megohms

\* Grid No.2 to Grid No.1.

## MEDIUM-MU TRIODE

**6BN4A**

Related types:  
2BN4A, 3BN4A

Miniature type used as rf amplifier tube in grid-drive circuits of vhf television tuners. The double base-pin connections for both cathode and grid reduce effective lead inductance and lead resistance with consequent reduction in input conductance. In addition, the basing arrangement facilitates isolation of input and output circuits and permits short, direct connections to base-pin terminals. Outline 5C, **Outlines** section. This type requires miniature seven-contact socket and may be mounted in any position. Types 2BN4A and 3BN4A are identical with type 6BN4A except for the heater ratings, as shown below.

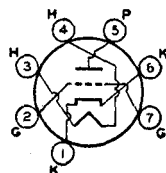

7EG

Heater Voltage (ac/dc) ..... 2.35 3 6.3 volts  
 Heater Current ..... 0.6 0.45 0.2 ampere  
 Heater Warm-up Time (Average) ..... 11 11 — seconds  
 Peak Heater-Cathode Voltage:  
 Heater negative with respect to cathode .. 100 max 100 max 100 max volts  
 Heater positive with respect to cathode .. 100 max 100 max 100 max volts  
 Direct Interelectrode Capacitances (Approx.):\*  
 Grid to Plate ..... 1.2 pF  
 Grid to Cathode and Heater ..... 3.2 pF  
 Plate to Cathode and Heater ..... 1.4 pF

	2BN4A	3BN4A	6BN4A	
Heater Voltage (ac/dc) .....	2.35	3	6.3	volts
Heater Current .....	0.6	0.45	0.2	ampere
Heater Warm-up Time (Average) .....	11	11	—	seconds
Peak Heater-Cathode Voltage:				
Heater negative with respect to cathode ..	100 max	100 max	100 max	volts
Heater positive with respect to cathode ..	100 max	100 max	100 max	volts
Direct Interelectrode Capacitances (Approx.):*				
Grid to Plate .....			1.2	pF
Grid to Cathode and Heater .....			3.2	pF
Plate to Cathode and Heater .....			1.4	pF

\* With external shield connected to cathode.

Class A<sub>1</sub> Amplifier

## MAXIMUM RATINGS (Design-Center Values):

Plate Voltage .....	275 max	volts
Grid Voltage, Positive-bias value .....	0 max	volts
Plate Dissipation .....	2.2 max	watts
Cathode Current .....	22 max	mA

## CHARACTERISTICS:

Plate-Supply Voltage .....	150	volts
Cathode-Bias Resistor .....	220	ohms
Amplification Factor .....	43	
Plate Resistance (Approx.) .....	5400	ohms
Transconductance .....	7700	μmhos
Grid Voltage (Approx.) for plate current of 100 μA .....	-6	volts
Plate Current .....	9	mA

## MAXIMUM CIRCUIT VALUE:

Grid-Circuit Resistance .....	0.5 max	megohm
-------------------------------	---------	--------

## BEAM TUBE

**6BN6**

Related types:  
3BN6, 4BN6

Miniature type used as combined limiter, discriminator, and audio-voltage amplifier in intercarrier television and FM receivers. Outline 5D, **Outlines** section. Tube requires miniature seven-contact socket and may be mounted in any position. Types 3BN6 and 4BN6 are identical with type 6BN6 except for the heater ratings, as shown below.

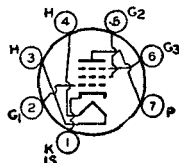

7DF

Heater Voltage (ac/dc) ..... 3.15 4.2 6.3 volts  
 Heater Current ..... 0.6 0.45 0.3 ampere  
 Heater Warm-Up Time (Average) ..... 11 11 — seconds  
 Peak Heater-Cathode Voltage:  
 Heater negative with respect to cathode .. 200 max 200 max 200 max volts  
 Heater positive with respect to cathode .. 200<sup>o</sup>max 200<sup>o</sup>max 200<sup>o</sup>max volts

	3BN6	4BN6	6BN6	
Heater Voltage (ac/dc) .....	3.15	4.2	6.3	volts
Heater Current .....	0.6	0.45	0.3	ampere
Heater Warm-Up Time (Average) .....	11	11	—	seconds
Peak Heater-Cathode Voltage:				
Heater negative with respect to cathode ..	200 max	200 max	200 max	volts
Heater positive with respect to cathode ..	200 <sup>o</sup> max	200 <sup>o</sup> max	200 <sup>o</sup> max	volts

\* The dc component must not exceed 100 volts.

**Limiter And Discriminator Service**

**MAXIMUM RATINGS (Design-Maximum Values):**

Plate-Supply Voltage .....	330 max	volts
Grid-No.2 Voltage .....	110 max	volts
Grid-No.1 Voltage, Positive peak value .....	60 max	volts
Cathode Current .....	13 max	mA

**TWIN DIODE—  
HIGH-MU TRIODE**

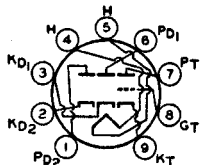

**9ER**

Miniature type used in a wide variety of applications in color and black-and-white television receivers. This type has a controlled heater warm-up time for use in receivers employing series-connected heater strings. The

**6BN8**

Related type:  
**8BN8**

triode unit is used in burst-amplifier, af amplifier, and low-frequency oscillator applications. The diode units are used in phase-detector, ratio-detector or discriminator, and horizontal afc discriminator circuits. Outline 6E, **Outlines** section. Tube requires miniature nine-contact socket and may be mounted in any position. Type 8BN8 is identical with type 6BN8 except for the heater ratings, as shown below.

	<b>6BN8</b>	<b>8BN8</b>	
Heater Voltage (ac/dc) .....	6.3	8.4	volts
Heater Current .....	0.6	0.45	ampere
Heater Warm-up Time (Average) .....	11	11	seconds
Peak Heater-Cathode Voltage:			
Heater negative with respect to cathode .....	200 max	200 max	volts
Heater positive with respect to cathode .....	200*max	200*max	volts
Direct Interelectrode Capacitances:			
Triode Grid to Triode Plate .....		2.5	pF
Triode Grid to Cathode and Heater .....		3.6	pF
Triode Plate to Cathode and Heater .....		0.25	pF
Plate of Diode Unit No.1 to Triode Grid .....		0.06 max	pF
Plate of Diode Unit No.2 to Triode Grid .....		0.1 max	pF
Plate of Diode Unit No.1 to Plate of Diode Unit No.2 .....		0.07 max	pF
Diode Cathode to All Other Electrodes (Each Diode Unit) .....		5	pF
Diode Plate to Diode Cathode and Heater (Each Diode Unit) ..		1.9	pF
Diode Cathode to Diode Plate and Heater (Each Diode Unit) ..		4.8	pF
Diode Plate to All Other Electrodes (Each Diode Unit) .....		3	pF

• The dc component must not exceed 100 volts.

**Triode Unit as Class A<sub>1</sub> Amplifier**

**MAXIMUM RATINGS (Design-Maximum Values):**

Plate Voltage .....	330 max	volts
Grid Voltage, Positive bias value .....	0 max	volts
Plate Dissipation .....	1.7 max	watts

**CHARACTERISTICS:**

Plate Voltage .....	100	250	volts
Grid Voltage .....	-1	-3	volts
Amplification Factor .....	75	70	
Plate Resistance (Approx.) .....	21000	28000	ohms
Transconductance .....	3500	2500	μmhos
Grid Voltage (Approx.) for plate current of 10 μA .....	-2.5	-5.5	volts
Plate Current .....	1.5	1.6	mA

**MAXIMUM CIRCUIT VALUE:**

Grid-Circuit Resistance .....	1.0 max	megohm
-------------------------------	---------	--------

**Diode Units**

**MAXIMUM RATINGS (Design-Maximum Values):**

Plate Current (Each Unit):		
Peak .....	54 max	mA
Average .....	9 max	mA

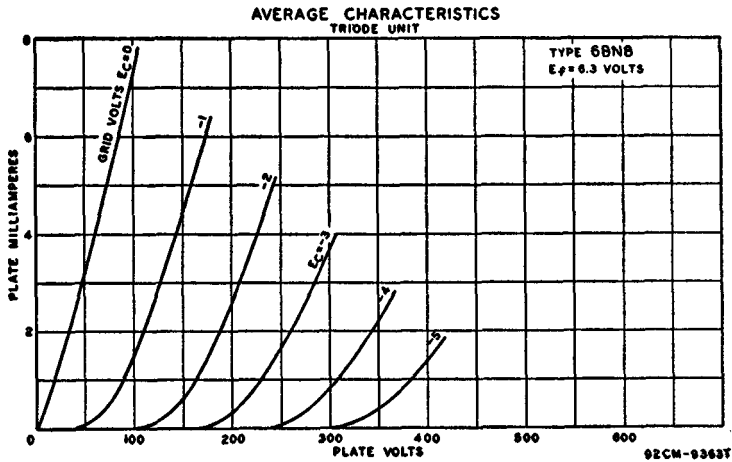

**POWER PENTODE**

**6BQ5**

Related type:  
8BQ5

Miniature type used in the output stage of audio-frequency amplifiers. Outline 6G, **Outlines** section. Tube requires miniature nine-contact socket and may be mounted in any position. Type 8BQ5 is identical with type 6BQ5

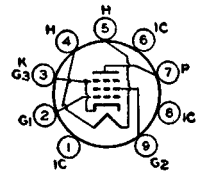

9CV

except for the heater ratings, as shown below.

	6BQ5	8BQ5	
Heater Voltage (ac/dc) .....	6.3	8	volts
Heater Current .....	0.76	0.6	ampere
Heater Warm-up Time (Average) .....	—	11	seconds
Peak Heater-Cathode Voltage:			
Heater negative with respect to cathode .....	100 max	100 max	volts
Heater positive with respect to cathode .....	100 max	100 max	volts
Direct Interelectrode Capacitances:			
Grid No.1 to Plate .....		0.5 max	pF
Grid No.1 to Cathode, Heater, Grid No.2, and Grid No.3 .....		10.8 max	pF
Plate to Cathode, Heater, Grid No.2, and Grid No.3 .....		6.5	pF
Grid No.1 to Heater .....		0.25 max	pF

▲ The dc component must not exceed 100 volts.

**Class A<sub>1</sub> Amplifier**

**MAXIMUM RATINGS (Design-Center Values):**

Plate Voltage .....	300 max	volts
Grid-No.2 (Screen-Grid) Voltage .....	300 max	volts
Grid-No.1 (Control-Grid) Voltage, Positive-bias value .....	0 max	volts
Grid-No.2 Input .....	2 max	watts
Plate Dissipation .....	12 max	watts
Cathode Current .....	65 max	mA

**TYPICAL OPERATION:**

Plate Voltage .....	250	volts
Grid-No.2 Voltage .....	250	volts
Grid-No.1 (Control-Grid) Voltage .....	-7.3	volts
Peak AF Grid-No.1 Voltage .....	6.2	volts
Zero-Signal Plate Current .....	48	mA
Maximum-Signal Plate Current .....	50.6	mA

Zero-Signal Grid-No.2 Current .....	5.5	mA
Maximum-Signal Grid-No.2 Current .....	10	mA
Plate Resistance (Approx.) .....	38000	ohms
Transconductance .....	11300	$\mu$ mhos
Load Resistance .....	4500	ohms
Total Harmonic Distortion .....	10	per cent
Maximum-Signal Power Output .....	5.7	watts

**MAXIMUM CIRCUIT VALUES:**

Grid-No.1-Circuit Resistance:		
For fixed-bias operation .....	0.3 max	megohm
For cathode-bias operation .....	1.0 max	megohm

**Push-Pull Class AB<sub>1</sub> Amplifier**

**MAXIMUM RATINGS:** (Same as for Single-Tube Class A<sub>1</sub> Amplifier)

**TYPICAL OPERATION** (Values are for two tubes):

Plate Supply Voltage .....	250	300	volts
Grid-No.2 Supply Voltage .....	250	300	volts
Cathode-Bias Resistor .....	130	130	ohms
Peak AF Grid-No.1-to-Grid-No.1 Voltage .....	22.6	28.3	volts
Zero-Signal Plate Current .....	62	72	mA
Maximum-Signal Plate Current .....	75	92	mA
Zero-Signal Grid-No.2 Current .....	7	8	mA
Maximum-Signal Grid-No.2 Current .....	15	22	mA
Effective Load Resistance (Plate-to-plate) .....	8000	8000	ohms
Total Harmonic Distortion .....	3	4	per cent
Maximum-Signal Power Output .....	11	17	watts

**MAXIMUM CIRCUIT VALUES:**

Grid-No.1-Circuit Resistance:		
For fixed-bias operation .....	0.3 max	megohm
For cathode-bias operation .....	1.0 max	megohm

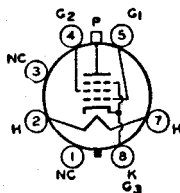

**6AM**

**BEAM POWER TUBE**

Glass octal type used as horizontal deflection amplifier in television receivers. Outline 14D, Outlines section.

Tube requires octal socket and may be mounted in any position. This type may be supplied with pin No.1

**6BQ6GTB  
/6CU6**

Related types:

12BQ6GTB/12CU6, 17BQ6GTB, 25BQ6GTB/25CU6

omitted. Types 12BQ6GTB/12CU6, 17BQ6GTB, and 25BQ6GTB/25CU6 are identical with type 6BQ6GTB/6CU6 except for the heater ratings, as shown below.

	6BQ6GTB/ 6CU6	12BQ6G- TB/12CU6	17BQ6- GTB	25BQ6GTB/ 25CU6	
Heater Voltage (ac/dc) .....	6.3	12.6	16.8	25	volts
Heater Current .....	1.2	0.6	0.45	0.3	ampere
Heater Warm-up Time (Average) ..	—	11	11	—	seconds
<b>Peak Heater-Cathode Voltage:</b>					
Heater negative with respect to cathode .....	200 max	200 max	200 max	200 max	volts
Heater positive with respect to cathode .....	200*max	200*max	200*max	200*max	volts
<b>Direct Interelectrode Capacitances (Approx.):</b>					
Grid No.1 to Plate .....				0.6	pF
Grid No.1 to Cathode, Heater, Grid No.2, and Grid No.3 .....				15	pF
Plate to Cathode, Heater, Grid No.2, and Grid No.3 .....				7	pF
Transconductance*				5900	$\mu$ mhos
Mu-Factor, Grid No.2 to Grid No.1** .....				4.3	

▪ The dc component must not exceed 100 volts.

\* For plate volts, 250; grid-No.2 volts, 150; grid-No.1 volts, -22.5; plate mA, 57; grid-No.2 mA, 2.1.

\*\* For plate and grid-No.2 volts, 150; grid-No.1 volts, -22.5.

### Horizontal Deflection Amplifier

For operation in a 525-line, 30-frame system

#### MAXIMUM RATINGS (Design-Center Values):

DC Plate Voltage	600 max	volts
Peak Positive-Pulse Plate Voltage* (Absolute Maximum)	600†max	volts
Peak Negative-Pulse Plate Voltage	-1250 max	volts
DC Grid-No.2 (Screen-Grid) Voltage	200 max	volts
Peak Negative-Pulse Grid-No.1 (Control-Grid) Voltage	-300 max	volts
Peak Cathode Current	400 max	mA
Average Cathode Current	110 max	mA
Grid-No.2 Input	2.5 max	watts
Plate Dissipation#	11 max	watts
Bulb Temperature (At hottest point)	220 max	°C

#### MAXIMUM CIRCUIT VALUE:

Grid-No.1-Circuit Resistance	0.47 max	megohm
------------------------------	----------	--------

\* The duration of the voltage pulse must not exceed 15 per cent of one horizontal scanning cycle. In a 525-line, 30-frame system, 15 per cent of one horizontal scanning cycle is 10 microseconds.

† Under no circumstances should this absolute value be exceeded.

# An adequate bias resistor or other means is required to protect the tube in the absence of excitation.

### MEDIUM-MU TWIN TRIODE

Miniature type used in direct-coupled cathode-drive rf amplifier circuits of vhf television tuners. In such circuits, one triode unit is used as the direct-coupled grounded-cathode driver for the other unit. This type is also used in

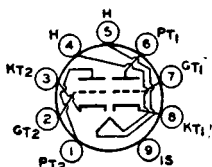

9AJ

push-pull cathode-drive rf amplifiers. Outline 6B, **Outlines** section. Tube requires miniature nine-contact socket and may be mounted in any position. For typical operation as a resistance-coupled amplifier, refer to **Resistance-Coupled Amplifier** section. Types 4BQ7A and 5BQ7A are identical with type 6BQ7A except for the heater ratings, as shown below.

	4BQ7A	5BQ7A	6BQ7A	
Heater Voltage (ac/dc)	4.2	5.6	6.3	volts
Heater Current	0.6	0.45	0.4	ampere
Heater Warm-up Time (Average)	11	11	—	seconds
Peak Heater-Cathode Voltage:				
Heater negative with respect to cathode	200*max	200*max	200*max	volts
Heater positive with respect to cathode	200*max	200*max	200*max	volts
Direct Interelectrode Capacitances:°		Unit No.1	Unit No.2	
Grid to Plate		1.2	1.2	pF
Grid to Cathode, Heater, and Internal Shield		2.6	—	pF
Cathode to Grid, Heater, and Internal Shield		—	5.0	pF
Plate to Cathode, Heater, and Internal Shield		1.2	—	pF
Plate to Grid, Heater, and Internal Shield		—	2.2	pF
Plate to Cathode		0.12	0.12	pF
Heater to Cathode		2.6	2.6	pF
Plate of Unit No.1 to Plate of Unit No.2			0.010 max	pF
Plate of Unit No.2 to Plate and Grid of Unit No.1			0.024 max	pF

\* With external shield connected to internal shield.

° In cathode-drive circuits with direct-coupled drive, it is permissible for this voltage to be as high as 300 volts.

▪ The dc component must not exceed 100 volts.

**Class A<sub>1</sub> Amplifier (Each Unit)**

**MAXIMUM RATINGS (Design-Center Values):**

Plate Supply Voltage .....	250*max	volts
Plate Dissipation .....	2 max	watts
Cathode Current .....	20 max	mA

**CHARACTERISTICS:**

Plate Supply Voltage .....	150	volts
Cathode-Bias Resistor .....	220	ohms
Amplification Factor .....	38	
Plate Resistance (Approx.) .....	5900	ohms
Transconductance .....	6400	$\mu$ mhos
Plate Current .....	9	mA
Grid Voltage (Approx.):		
For plate current of 100 $\mu$ A .....	-6.5	volts
For plate current of 10 $\mu$ A .....	-	volts

**MAXIMUM CIRCUIT VALUE:**

Grid-Circuit Resistance .....	0.5 max	megohm
-------------------------------	---------	--------

\* In cathode-drive circuits with direct-coupled drive, it is permissible for this voltage to be as high as 300 volts.

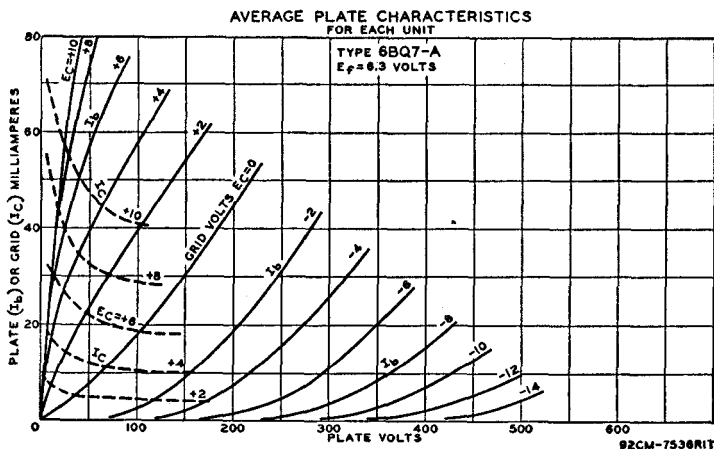

**MEDIUM-MU TRIODE—SHARP-CUTOFF PENTODE**

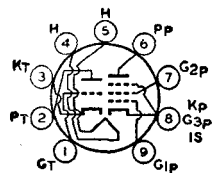

**9FA**

Miniature type used in a wide variety of applications in color and black-and-white television receivers. Especially useful as combined triode oscillator and pentode mixer in vhf television tuners. Tube has a controlled heater warm-up time for use in receivers employing series-connected heater strings. Outline 6B, **Outlines** section. Except for basing arrangement and grid-No.1-to-plate capacitance of pentode unit, this type is identical with type 6U8A.

**6BR8A**

Related type:  
**5BR8**

Outline 6B, **Outlines** section. Except for basing arrangement and grid-No.1-to-plate capacitance of pentode unit, this type is identical with type 6U8A.

## HALF-WAVE VACUUM RECTIFIER

### 6BS3 6BS3A

**Related types:**  
12BS3, 12BS3A,  
17BS3, 17BS3A

Novar types used as damper tubes in horizontal-deflection circuits of black-and-white television receivers. Outlines 11D and 30B, respectively, **Outlines** section. Tubes require novar nine-contact socket and may be mounted in

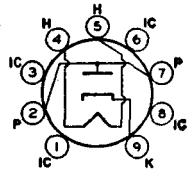

9HP

any position. Socket terminals 1, 3, 6, and 8 should not be used as tie points; it is recommended that socket clips for these pins be removed to reduce the possibility of arc-over and to minimize leakage. It is especially important that these tubes, like other power-handling tubes, be adequately ventilated. Types 12BS3 and 12BS3A and types 17BS3 and 17BS3A are identical with types 6BS3 and 6BS3A, respectively, except for the heater ratings, as shown below.

	6BS3 6BS3A	12BS3 12BS3A	17BS3 17BS3A	
Heater Voltage (ac/dc) .....	6.3	12.6	16.8	volts
Heater Current .....	1.2	0.6	0.45	ampere seconds
Heater Warm-up Time (Average) .....	—	11	11	
Direct Interelectrode Capacitances (Approx.):				
Plate to Cathode and Heater .....			6.5	pF
Cathode to Plate and Heater .....			9	pF
Heater to Cathode .....			2.8	pF

### Damper Service

For operation in a 525-line, 30-frame system

#### MAXIMUM RATINGS (Design-Maximum Values):

Peak Inverse Plate Voltage*	5000 max	volts
Peak Plate Current .....	1100 max	mA
DC Plate Current .....	200 max	mA
Plate Dissipation .....	6 max	watts
Peak Heater-Cathode Voltage:		
Heater negative with respect to cathode .....	5000* max	volts
Heater positive with respect to cathode .....	3000 max	volts

#### CHARACTERISTICS, Instantaneous Value:

Tube Voltage Drop for plate current of 140 mA .....	12	volts
---	----	-------

\* The duration of the voltage pulse must not exceed 15 per cent of one horizontal scanning cycle. In a 525-line, 30-frame system, 15 per cent of one horizontal scanning cycle is 10 microseconds.

\* The dc component must not exceed 900 volts.

□ The dc component must not exceed 100 volts.

## MEDIUM-MU TWIN TRIODE

Miniature type used in direct-coupled cathode-drive rf amplifier circuits of vhf television tuners. In such circuits, one triode unit is used as the direct-coupled grounded-cathode driver for the other unit. This type is also used

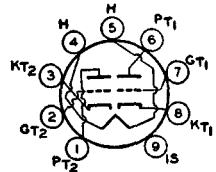

9AJ

in push-pull cathode-drive rf amplifiers. Outline 6B, **Outlines** section. Tube requires miniature nine-contact socket and may be mounted in any position. Type 4BS8 is identical with type 6BS8 except for the heater ratings, as shown below.

	4BS8	6BS8	
Heater Voltage (ac/dc) .....	4.5	6.3	volts
Heater Current .....	0.6	0.4	ampere seconds
Heater Warm-up Time (Average) .....	11	—	
Peak Heater-Cathode Voltage:			
Heater negative with respect to cathode .....	200 max	200 max	volts
Heater positive with respect to cathode .....	200 max	200 max	volts



Direct Interelectrode Capacitances:

Grid to Plate (Each Unit) .....	1.15	pF
Grid to Cathode, Heater, and Internal Shield (Unit No.1) .....	2.6	pF
Plate to Cathode, Heater, and Internal Shield (Unit No.1) .....	1.2	pF
Plate to Cathode (Each Unit) .....	0.15 max	pF
Heater to Cathode (Each Unit) .....	2.6	pF
Cathode to Grid, Heater, and Internal Shield (Unit No.2) .....	5	pF
Plate to Grid, Heater, and Internal Shield (Unit No.2) .....	2.2	pF
Plate of Unit No.1 to Plate of Unit No.2 .....	0.010 max	pF
Plate of Unit No.2 to Plate and Grid of Unit No.1 .....	0.024 max	pF

**Class A<sub>1</sub> Amplifier (Each Unit)**

**MAXIMUM RATINGS (Design-Center Values):**

Plate Voltage .....	150 max	volts
Plate Dissipation .....	2 max	watts
Cathode Current .....	20 max	mA

**CHARACTERISTICS:**

Plate-Supply Voltage .....	150	volts
Cathode-Bias Resistor .....	220	ohms
Amplification Factor .....	36	
Plate Resistance (Approx.) .....	5000	ohms
Transconductance .....	7200	μmhos
Plate Current .....	10	mA
Grid Voltage (Approx.) for plate current of 10 μA* .....	-7	volts

**MAXIMUM CIRCUIT VALUE:**

Grid-Circuit Resistance .....	0.5 max	megohm
-------------------------------	---------	--------

\* This value applies to Unit No.2 only.

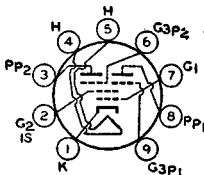

**9FG**

Types 3BU8 and 4BU8 are identical with type 6BU8 except for the heater ratings, as shown below.

**SHARP-CUTOFF TWIN PENTODE**

Miniature type used as combined sync separator, sync clipper, and agc amplifier tube in television receivers. Outline 6E, Outlines section. Tube requires miniature nine-contact socket and may be mounted in any position.

**6BU8**

Related types:  
3BU8, 4BU8

Heater Voltage (ac/dc) .....	3BU8	4BU8	6BU8	
Heater Current .....	3.15	4.2	6.3	volts
Heater Warm-up Time (Average) .....	0.6	0.45	0.3	ampere
Peak Heater-Cathode Voltage:	11	11	—	seconds

Heater negative with respect to cathode ..	200 max	200 max	200 max	volts
Heater positive with respect to cathode ..	200*max	200*max	200*max	volts

Direct Interelectrode Capacitances:

Grid No.3 to Plate (Each Unit) .....	1.9	pF
Grid No.1 to All Other Electrodes .....	6	pF
Grid No.3 to All Other Electrodes (Each Unit) .....	3.6	pF
Plate to All Other Electrodes (Each Unit) .....	3	pF
Grid No.3 of Unit No.1 to Grid No.3 of Unit No.2 .....	0.015 max	pF

▪ The dc component must not exceed 100 volts.

**Class A<sub>1</sub> Amplifier**

**MAXIMUM RATINGS (Design-Maximum Values):**

Plate Voltage (Each Unit) .....	300 max	volts
---------------------------------	---------	-------

## Grid-No.3 (Suppressor-Grid) Voltage (Each Unit):

Peak positive value .....	50 max	volts
DC negative value .....	-50 max	volts
DC positive value .....	3 max	volts
Grid-No.2 (Screen-Grid) Voltage .....	150 max	volts
Grid-No.1 (Control-Grid) Voltage, Negative bias value .....	-50 max	volts
Cathode Current .....	12 max	mA
Grid-No.2 Input .....	0.75 max	watt
Plate Dissipation (Each Unit) .....	1.1 max	watts

**CHARACTERISTICS:** With Both Units Operating

Plate Voltage (Each Unit) .....	100	100	volts
Grid-No.3 Voltage (Each Unit) .....	-10	0	volts
Grid-No.2 Voltage .....	67.5	67.5	volts
Grid-No.1 Voltage .....	*	*	volts
Plate Current (Each Unit) .....	—	2.2	mA
Grid-No.2 Current .....	6.5	3.3	mA
Cathode Current .....	6.6	7.8	mA

## With One Unit Operating†

Plate Voltage .....	100	100	volts
Grid-No.3 Voltage .....	0	0	volts
Grid-No.2 Voltage .....	67.5	67.5	volts
Grid-No.1 Voltage .....	0	*	volts
Grid-No.3 Transconductance .....	—	180	$\mu$ mhos
Grid-No.1 Transconductance .....	1500	—	$\mu$ mhos
Plate Current .....	—	2.2	mA
Grid-No.3 Voltage (Approx.) for plate current of 100 $\mu$ A .....	—	-4.5	volts
Grid-No.1 Voltage (Approx.) for plate current of 100 $\mu$ A .....	—	-2.3	volts

**MAXIMUM CIRCUIT VALUES:**

Grid-No.3-Circuit Resistance (Each Unit) .....	0.5 max	megohm
Grid-No.1-Circuit Resistance .....	0.5 max	megohm

\* Adjusted to give a dc grid-No.1 current of 100 microamperes.

† With plate and grid No.3 of the other unit connected to ground.

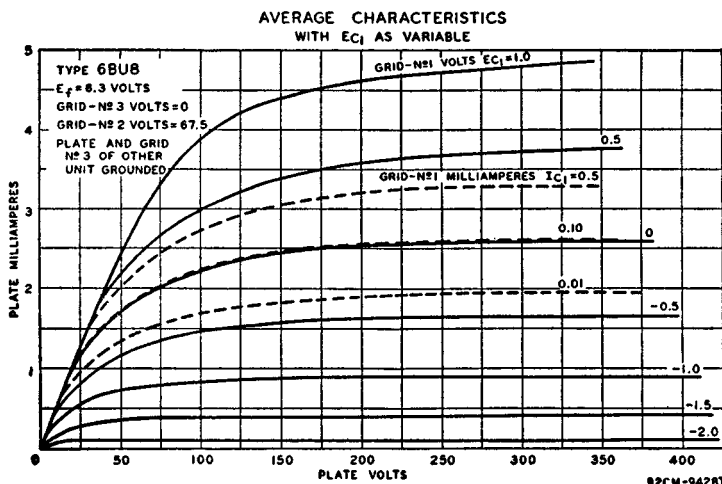

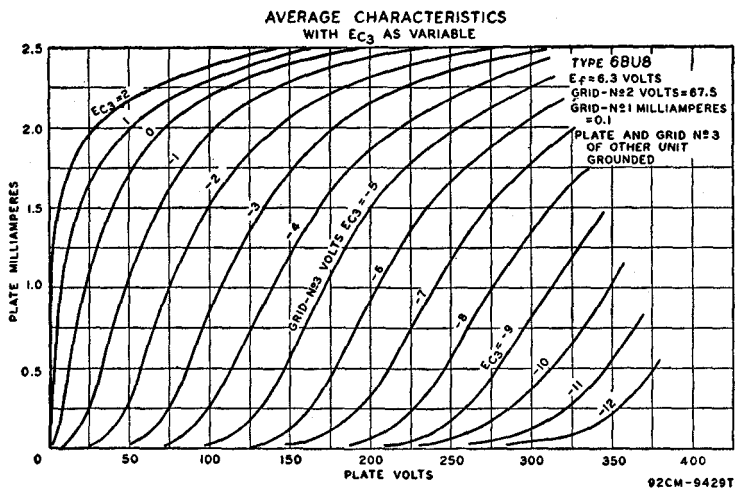

**TWIN DIODE—  
SHARP-CUTOFF PENTODE**

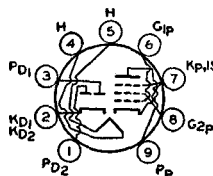

**9HK**

Miniature type used in television receivers; diodes are used as horizontal phase detectors; pentode is used as a sound if amplifier, sound limiter, and agc keyer. Outline 6B, *Outlines* section. Tube requires miniature nine-

**6BW8**

Related type:  
**5BW8**

contact socket and may be operated in any position. Type 5BW8 is identical with type 6BW8 except for the heater ratings, as shown below.

	<b>5BW8</b>	<b>6BW8</b>	
Heater Voltage (ac/dc) .....	4.7	6.3	volts
Heater Current .....	0.6	0.45	ampere
Heater Warm-up Time (Average) .....	11	—	seconds
Peak Heater-Cathode Voltage:			
Heater negative with respect to cathode .....	200 max	200 max	volts
Heater positive with respect to cathode .....	200*max	200*max	volts
Direct Interelectrode Capacitances:			
Pentode Unit:			
Grid No.1 to Plate .....		0.02 max	pF
Grid No.1 to Cathode, Heater, Grid No.2, Grid No.3, and Internal Shield .....		4.8	pF
Plate to Cathode, Heater, Grid No.2, Grid No.3, and Internal Shield .....		2.6	pF
Plate of Diode Unit No.1 to Cathode and Heater .....		1.3	pF
Plate of Diode Unit No.2 to Cathode and Heater .....		1.2	pF
Pentode Grid No.1 to Either Diode Plate .....		0.006 max	pF

\* The dc component must not exceed 100 volts.

**Pentode Unit as Class A<sub>1</sub> Amplifier**

**MAXIMUM RATINGS** (Design-Maximum Values):

Plate Voltage .....	330 max	volts
Grid-No.2 (Screen-Grid) Supply Voltage .....	330 max	volts
Grid-No.2 Voltage .....	See curve page 80	
Grid-No.1 (Control-Grid) Voltage:		
Positive-bias value .....	0 max	volts
Negative-bias value .....	-55 max	volts

Grid-No.2 Input:		
For grid-No.2 voltages up to 165 volts	0.55 max	watt
For grid-No.2 voltages between 165 and 330 volts	See curve page 80	
Plate Dissipation	3 max	watts

**CHARACTERISTICS:**

Plate Voltage	250	volts
Grid-No.2 Voltage	110	volts
Cathode-Bias Resistor	68	ohms
Plate Resistance (Approx.)	0.25	megohm
Transconductance	5200	$\mu$ mhos
Grid-No.1 Voltage (Approx.) for plate current of 10 $\mu$ A	-10	volts
Plate Current	10	mA
Grid-No.2 Current	3.5	mA

**MAXIMUM CIRCUIT VALUES:**

Grid-No.1 Circuit Resistance:		
For fixed-bias operation	0.1 max	megohm
For cathode-bias operation	0.5 max	megohm

**Diode Units (Each Unit)****MAXIMUM RATINGS (Design-Maximum Value):**

Plate Current	5 max	mA
---------------	-------	----

**PENTAGRID AMPLIFIER****6BY6**Related type:  
3BY6

Miniature type used as a gated amplifier in color television receivers. In such service, it may be used as a combined sync separator and sync clipper. Outline 5C, **Outlines** section. Tube requires miniature seven-contact socket

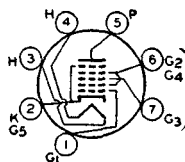
**7CH**

and may be mounted in any position. Type 3BY6 is identical with type 6BY6 except for the heater ratings, as shown below.

	3BY6	6BY6	
Heater Voltage (ac/dc)	3.15	6.3	volts
Heater Current	0.6	0.3	ampere
Heater Warm-up Time (Average)	11	—	seconds
Peak Heater-Cathode Voltage:			
Heater negative with respect to cathode	200 max	200 max	volts
Heater positive with respect to cathode	200*max	200*max	volts
Direct Interelectrode Capacitances:			
Grid No.1 to Plate		0.08 max	pF
Grid No.3 to Plate		0.35 max	pF
Grid No.1 to Grid No.3		0.22 max	pF
Grid No.1 to All Other Electrodes		5.4	pF
Grid No.3 to All Other Electrodes		6.9	pF
Plate to All Other Electrodes		7.6	pF

\* The dc component must not exceed 100 volts.

**Class A<sub>1</sub> Amplifier****CHARACTERISTICS:**

Plate Voltage	250	volts
Grids-No.2-and-No.4 Voltage	100	volts
Grid-No.3 Voltage	-2.5	volts
Grid-No.1 Voltage	-2.5	volts
Grid-No.3-to-Plate Transconductance	500	$\mu$ mhos
Grid-No.1-to-Plate Transconductance	1900	$\mu$ mhos
Plate Current	6.5	mA
Grids-No.2-and-No.4 Current	9	mA
Grid-No.3 Volts (Approx.) for plate current of 35 $\mu$ A and grid-No.1 volts = -4	-15	volts
Grid-No.1 Volts (Approx.) for plate current of 35 $\mu$ A and grid-No.3 volts = 0	-12	volts

Gated Amplifier

MAXIMUM RATINGS (Design-Maximum Values):

Plate Voltage	330 max	volts
Grids-No.2-and-No.4 Voltage	See curve page 80	
Grids-No.2-and-No.4 Supply Voltage	330 max	volts
Grid-No.3 Voltage:		
Negative bias value	-55 max	volts
Positive bias value	0 max	volts
Positive peak value	27 max	volts
Grid-No.1 Voltage, Negative bias value	-110 max	volts
Plate Dissipation	2.3 max	watts
Grid-No.3 Input	0.1 max	watt
Grids-No.2-and-No.4 Input:		
For grids-No.2-and-No.4 voltages up to 165 volts	1.1 max	watts
For grids-No.2-and-No.4 voltages between 165 and 330 volts	See curve page 80	
Grid-No.1 Input	0.1 max	watt

CHARACTERISTICS AS SYNC SEPARATOR AND SYNC CLIPPER:

Plate Voltage	10	volts
Grid-No.3 Voltage	0	volts
Grids-No.2-and-No.4 Voltage	25	volts
Grid-No.1 Voltage	0	volts
Plate Current	1.4	mA
Grids-No.2-and-No.4 Current	3.5	mA
Grid-No.3 Volts (Approx.) for plate voltage of 25 volts, grids-No.2-and-No.4 voltage of 25 volts, grid-No.1 voltage of 0 volts, and plate current of 50 $\mu$ A	-2.5	volts
Grid-No.1 Volts (Approx.) for plate voltage of 25 volts, grids-No.2-and-No.4 voltage of 25 volts, grid-No.3 voltage of 0 volts, and plate current of 50 $\mu$ A	-2.3	volts

MAXIMUM CIRCUIT VALUES:

Grid-No.1 or Grid-No.3-Circuit Resistance:		
For fixed-bias operation	0.5 max	megohm
For cathode-bias operation	1.0 max	megohm

AVERAGE OPERATION CHARACTERISTICS

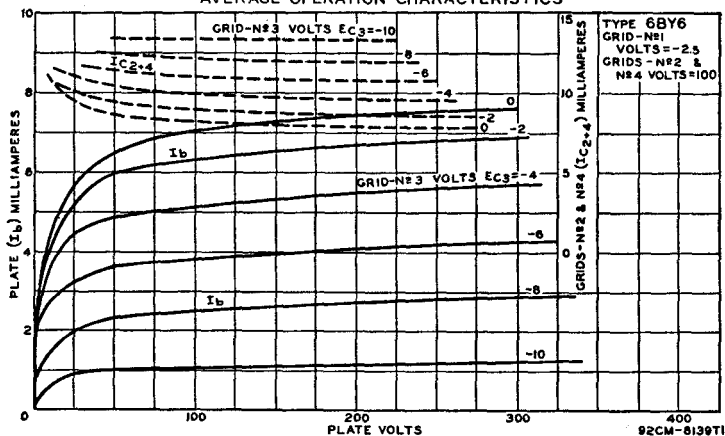

DIODE—  
SHARP-CUTOFF PENTODE

Miniature type used in diversified applications in television receivers. The pentode unit is used as an rf amplifier and the high-perveance diode as a limiter or detector. This type has a controlled heater warm-up time for

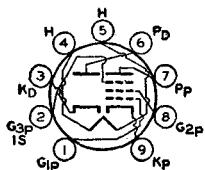

9FN

6BY8

use in receivers employing series-connected heater strings. Outline 6E, **Outlines** section. Tube requires miniature nine-contact socket and may be mounted in any position.

Heater Voltage (ac/dc)	6.3	volts
Heater Current	0.6	ampere
Heater Warm-up Time (Average)	11	seconds
Peak Heater-Cathode Voltage:		
Heater negative with respect to cathode	200 max	volts
Heater positive with respect to cathode	200 max	volts
Direct Interelectrode Capacitances: <sup>o</sup>		
Pentode Unit:		
Grid No.1 to Plate	0.0035 max	pF
Grid No.1 to Cathode, Heater, Grid No.2, Grid No.3, and Internal Shield	5.5	pF
Plate to Cathode, Heater, Grid No.2, Grid No.3, and Internal Shield	5	pF
Diode Plate to All Other Electrodes	4.8*	pF

<sup>Δ</sup> The dc component must not exceed 100 volts.

<sup>o</sup> With external shield connected to cathode of pentode unit (pin 9), except as noted.

\* With external shield connected to ground.

### Pentode Unit as Class A<sub>1</sub> Amplifier

#### MAXIMUM RATINGS (Design-Center Values):

Plate Voltage	300 max	volts
Grid-No.3 (Suppressor-Grid) Voltage, Positive value	0 max	volts
Grid-No.2 (Screen Grid) Supply Voltage	300 max	volts
Grid-No.2 Voltage	See curve page 80	
Grid-No.1 (Control-Grid) Voltage:		
Negative bias value	-50 max	volts
Positive bias value	0 max	volts
Plate Dissipation	3 max	watts
Grid-No.2 Input:		
For grid-No.2 voltages up to 150 volts	0.65 max	watt
For grid-No.2 voltages between 150 and 300 volts	See curve page 80	

#### CHARACTERISTICS:

Plate Supply Voltage	100	250	volts
Grid No.3		Connect to cathode at socket	
Grid-No.2 Supply Voltage	100	150	volts
Cathode-Bias Resistor	150	68	ohms
Plate Resistance (Approx.)	0.5	1	megohm
Transconductance	3900	5200	μmhos
Grid-No.1 Voltage (Approx.) for plate current of 10 μA	-4.2	-6.5	volts
Plate Current	5	10.6	mA
Grid-No.2 Current	2.1	4.3	mA

#### MAXIMUM CIRCUIT VALUES:

Grid-No.1-Circuit Resistance:		
For fixed-bias operation	0.25 max	megohm
For cathode-bias operation	1.0 max	megohm

### Diode Unit

#### MAXIMUM RATINGS (Design-Center Values):

Peak Inverse Plate Voltage	430 max	volts
Peak Plate Current	180 max	mA
DC Plate Current	45 max	mA

### SEMIREMOTE-CUTOFF PENTODE

Miniature type used in gain-controlled video if stages of television receivers. Outline 5C, **Outlines** section. Tube requires miniature seven-contact socket and may be mounted in any position.

Types 3BZ6, 4BZ6, and 12BZ6 are identical with type 6BZ6 except for the heater ratings, as shown below.

## 6BZ6

Related types:

3BZ6, 4BZ6, 12BZ6

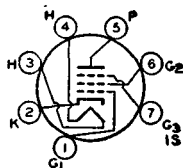

TCM

	3BZ6	4BZ6	6BZ6	12BZ6	
Heater Voltage (ac/dc)	3.15	4.2	6.3	12.6	volts
Heater Current	0.6	0.45	0.3	0.15	ampere
Heater Warm-up Time (Average)	11	11	—	—	seconds
Peak Heater-Cathode Voltage:					
Heater negative with respect to cathode	200 max	200 max	200 max	200 max	volts
Heater positive with respect to cathode	200*max	200*max	200*max	200*max	volts
Direct Interelectrode Capacitances:					
Grid No.1 to Plate			Without External Shield	With External Shield <sup>Δ</sup>	pF
Grid No.1 to Cathode, Heater, Grid No.2, Grid No.3, and Internal Shield			0.025 max	0.015 max	
Plate to Cathode, Heater, Grid No.2, Grid No. 3, and Internal Shield			7	7	pF
			2	3	pF

\* The dc component must not exceed 100 volts.

Δ With external shield connected to cathode.

### Class A<sub>1</sub> Amplifier

#### MAXIMUM RATINGS (Design-Maximum Values):

Plate Voltage	330 max	volts
Grid No.3 (Suppressor-Grid) Voltage, Positive Value	0 max	volts
Grid-No.2 (Screen-Grid) Supply Voltage	330 max	volts
Grid-No.2 Voltage	See curve page 80	
Grid-No.1 (Control-Grid) Voltage, Positive bias value	0 max	volts
Plate Dissipation	2.3 max	watts
Grid-No.2 Input:		
For grid-No.2 voltages up to 165 volts	0.55 max	watt
For grid-No.2 voltages between 165 and 330 volts	See curve page 80	

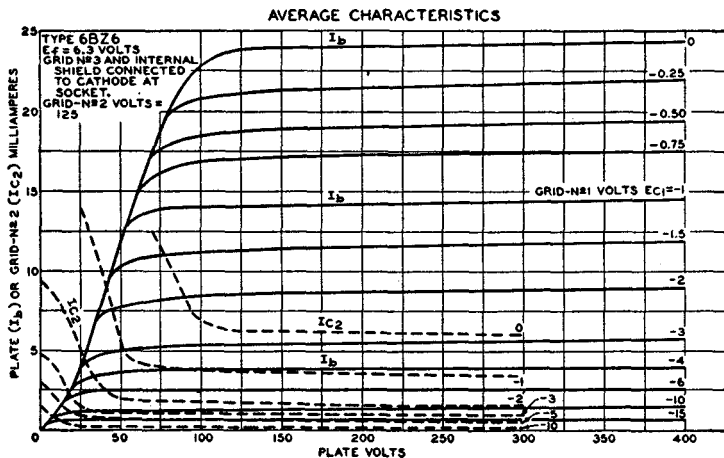

92CM-8508T3

#### CHARACTERISTICS:

Plate Supply Voltage	125	volts
Grid No.3	Connected to cathode at socket	
Grid-No.2 Supply Voltage	125	volts
Cathode-Bias Resistor	56	ohms
Plate Resistance (Approx.)	0.26	megohm
Transconductance	8000	μmhos
Grid-No.1 Voltage (Approx.) for transconductance of 50 μmhos	-19	volts
Grid No.1 Voltage (Approx.) for transconductance of 700 μmhos and cathode resistor of 0 ohms	-4.5	volts
Plate Current	14	mA
Grid-No.2 Current	3.6	mA

**MAXIMUM CIRCUIT VALUES:**

Grid-No.1-Circuit Resistance:

For fixed-bias operation .....	0.25 max megohm
For cathode-bias operation .....	1.0 max megohm

**MEDIUM-MU TWIN TRIODE****6BZ7**Related type:  
4BZ7

Miniature type used in direct-coupled cathode-drive rf amplifier circuits of vhf television tuners. In such circuits, one triode unit is used as the direct-coupled grounded-cathode driver for the other unit. This type is also used

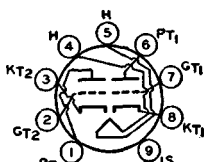

9AJ

in push-pull cathode-drive rf amplifiers. Outline 6B, **Outlines** section. Tube requires miniature nine-contact socket and may be mounted in any position. For typical operation as a resistance-coupled amplifier, refer to **Resistance-Coupled Amplifier** section. Type 4BZ7 is identical with type 6BZ7 except for the heater ratings, as shown below.

	4BZ7	6BZ7	
Heater Voltage (ac/dc) .....	4.2	6.3	volts
Heater Current .....	0.6	0.4	ampere
Heater Warm-up Time (Average) .....	11	—	seconds
<b>Peak Heater-Cathode Voltage:</b>			
Heater negative with respect to cathode .....	200*max	200*max	volts
Heater positive with respect to cathode .....	200*max	200*max	volts
<b>Direct Interelectrode Capacitances:</b>			
Grid to Plate (Each Unit) .....		1.2	pF
Grid to Cathode, Heater, and Internal Shield (Unit No.1) .....		2.6	pF
Plate to Cathode, Heater, and Internal Shield (Unit No.1) .....		1.2	pF
Plate to Cathode (Each Unit) .....		0.12	pF
Heater to Cathode (Each Unit) .....		2.6	pF
Cathode to Grid, Heater, and Internal Shield (Unit No.2) .....		5	pF
Plate to Grid, Heater, and Internal Shield (Unit No.2) .....		2.2	pF
Plate of Unit No.1 to Plate of Unit No.2 .....		0.010 max	pF
Plate of Unit No.2 to Plate and Grid of Unit No.1 .....		0.024 max	pF

\* In cathode-drive circuits with direct-coupled drive, it is permissible for this voltage to be as high as 300 volts under cutoff conditions.

\* The dc component must not exceed 100 volts.

**AVERAGE CHARACTERISTICS**  
EACH UNIT

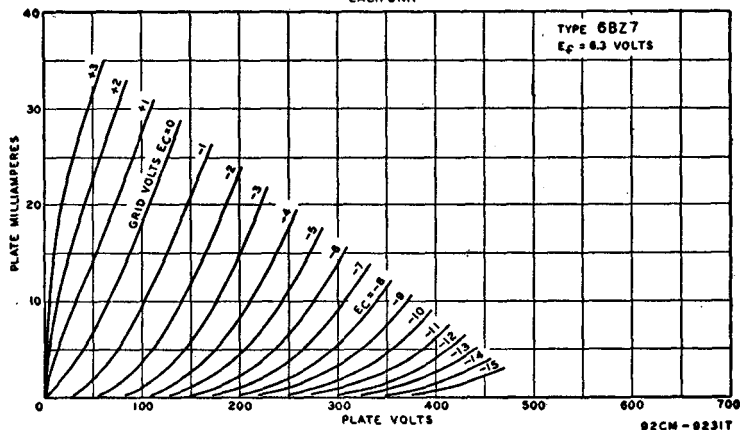

92CM-9231T



**Class A<sub>1</sub> Amplifier**

**MAXIMUM RATINGS (Design-Center Values):**

Plate Voltage .....	250*max	volts
Plate Dissipation .....	2.0 max	watts
Cathode Current .....	20 max	mA

**CHARACTERISTICS:**

Plate Supply Voltage .....	150	volts
Cathode-Bias Resistor .....	220	ohms
Amplification Factor .....	36	
Plate Resistance (Approx.) .....	5300	ohms
Transconductance .....	6800	μmhos
Plate Current .....	10	mA
Grid Voltage (Approx.) for plate current of 100 μA .....	-7	volts

**MAXIMUM CIRCUIT VALUE:**

Grid-Circuit Resistance .....	0.5 max	megohm
-------------------------------	---------	--------

\* In cathode-drive circuits with direct-coupled drive, it is permissible for this voltage to be as high as 300 volts under cutoff conditions.

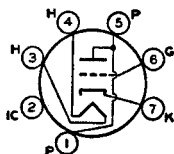

**6BG**

**POWER TRIODE**

Miniature type used in compact radio equipment as a local oscillator in FM and other high-frequency circuits. It may also be used as a class C rf amplifier. In such service, it delivers a power output of 5.5 watts at moder-

**6C4**

ate frequencies, and 2.5 watts at 150 megacycles per second. Outline 5C, **Outlines** section. Tube requires miniature seven-contact socket and may be mounted in any position. For typical operation as a resistance-coupled amplifier, refer to **Resistance-Coupled Amplifier** section. For additional curve of plate characteristics, refer to type 12AU7A.

Heater Voltage (ac/dc) .....	6.3	volts
Heater Current .....	0.15	ampere
Peak Heater-Cathode Voltage:		
Heater negative with respect to cathode .....	200 max	volts
Heater positive with respect to cathode .....	200*max	volts

	Without External Shield	With External Shield <sup>Δ</sup>	
Direct Interelectrode Capacitances (Approx.):			
Grid to Plate .....	1.6	1.4	pF
Grid to Cathode and Heater .....	1.8	1.8	pF
Plate to Cathode and Heater .....	1.3	2.5	pF

▪ The dc component must not exceed 100 volts.  
<sup>Δ</sup> With external shield connected to cathode.

**Class A<sub>1</sub> Amplifier**

**MAXIMUM RATINGS (Design-Center Values):**

Plate Voltage .....	300 max	volts
Plate Dissipation .....	3.5 max	watts

**CHARACTERISTICS:**

Plate Voltage .....	100	250	volts
Grid Voltage* .....	0	-8.5	volts
Amplification Factor .....	19.5	17	
Plate Resistance (Approx.) .....	6250	7700	ohms
Transconductance .....	3100	2200	μmhos
Plate Current .....	11.8	10.5	mA
Grid Voltage (Approx.) for plate current of 10 μA ..	-10	-25	volts

**MAXIMUM CIRCUIT VALUES:**

Grid-Circuit Resistance:		
For fixed bias operation .....	0.25 max	megohm
For cathode-bias operation .....	1.0 max	megohm

\* Transformer- or impedance-type input coupling devices are recommended to minimize resistance in the grid circuit.

## RF Power Amplifier and Oscillator—Class C Telegraphy

## MAXIMUM RATINGS (Design-Center Values):

Plate Voltage	300 max	volts
Grid Voltage	-50 max	volts
Plate Current	25 max	mA
Grid Current	8 max	mA
Plate Dissipation	5 max	watts

## TYPICAL OPERATION AT FREQUENCIES UP TO 50 Mc/s:

Plate Voltage	300	volts
Grid Voltage	-27	volts
Plate Current	25	mA
Grid Current (Approx.)	7	mA
Driving Power (Approx.)	0.35	watt
Power Output (Approx.)*	5.5	watts

\* Approximately 2.5 watts power output can be obtained when the 6C4 is used at 150 megacycles as an oscillator with grid resistor of 10,000 ohms and with maximum rated input.

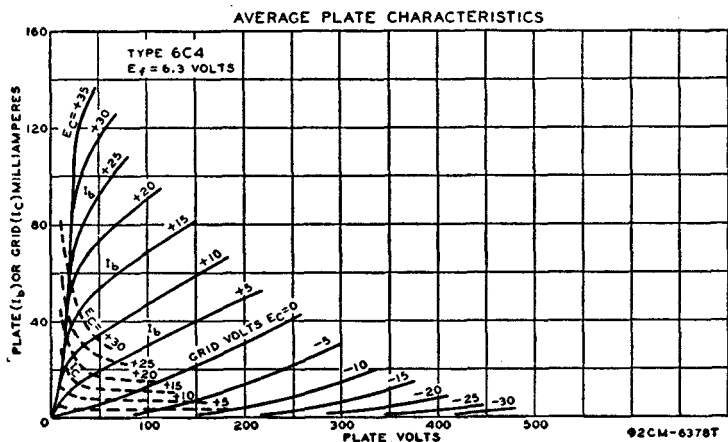

## SHARP-CUTOFF DUAL TETRODE

6C9

Related type:  
17C9

Miniature type used as vhf rf-amplifier and autodyne mixer tube. Outline 6B, Outlines section, except center pin is added to base. Tube requires miniature ten-contact socket and may be mounted in any position. Type 17C9

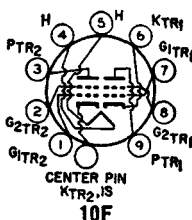

is identical with type 6C9 except for the heater ratings, as shown below.

	6C9	17C9	
Heater Voltage (ac/dc)	6.3	16.8	volts
Heater Current	0.4	0.15	ampere
Peak Heater-Cathode Voltage:			
Heater negative with respect to cathode	100 max	100 max	volts
Heater positive with respect to cathode	100 max	100 max	volts
Direct Interelectrode Capacitances:			
	Unit No.1	Unit No.2	
Grid No.1 to Plate	0.055 max	0.06 max	pF
Grid No.1 to Cathode, Heater, Grid No.2, and Internal Shield	4.4	4.2	pF
Plate to Cathode, Heater, Grid No.2, and Internal Shield	2.2	2.2	pF
Heater to Cathode	4.2	4.8	pF

Plate of Unit No.1 to Plate of Unit No.2 .....	0.003 max	pF
Grid No.1 of Unit No.1 to Grid No.1 of Unit No.2 .....	0.001 max	pF
Grid No.1 of Unit No.1 to Plate of Unit No.2 .....	0.001 max	pF
Grid No.1 of Unit No.2 to Plate of Unit No.1 .....	0.032 max	pF

**Class A<sub>1</sub> Amplifier (Each Unit)**

**MAXIMUM RATINGS (Design-Maximum Values):**

Plate Voltage .....	250 max	volts
Grid-No.2 (Screen-Grid) Supply Voltage .....	180 max	volts
Grid-No.2 Voltage .....	See curve page 80	
Cathode Current .....	20 max	mA
Plate Dissipation:		
Either plate .....	1.5 max	watts
Both plates (both units operating) .....	2.5 max	watts
Grid-No.2 Input:		
For grid-No.2 voltages up to 90 volts .....	0.5 max	watt
For grid-No.2 voltages between 90 and 180 volts .....	See curve page 80	

**CHARACTERISTICS:**

Plate Voltage .....	125	volts
Grid-No.2 Voltage .....	80	volts
Grid-No.1 Voltage .....	-1	volt
Plate Resistance (Approx.) .....	0.1	megohm
Transconductance .....	8000	$\mu$ mhos
Plate Current .....	10	mA
Grid-No.2 Current .....	1.5	mA
Grid-No.1 Voltage (Approx.) for plate current of 20 $\mu$ A .....	-6	volts

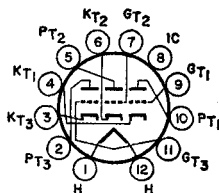

**12BQ**

**HIGH-MU TRIPLE TRIODE**

Duodecax type used for resistance-coupled voltage amplifiers, phase inverters, and other circuits requiring high voltage gain. Outline 8A, Outlines section. Type requires duodecax twelve-contact socket and may be

**6C10**

mounted in any position. Heater volts (ac/dc), 6.3; amperes, 0.6; average warm-up time (for series heater operation), 11 seconds; peak heater-cathode volts, 200 (the dc component must not exceed 100 volts when the heater is positive with respect to the cathode).

**Class A<sub>1</sub> Amplifier**

**MAXIMUM RATINGS (Design-Maximum Values, Each Triode Unit):**

Plate Voltage .....	330 max	volts
Grid Voltage:		
Positive-bias value .....	0 max	volts
Negative-bias value .....	-50 max	volts
Plate Dissipation .....	1 max	volt
Total Plate Dissipation (All plates) .....	3 max	watts

**CHARACTERISTICS (Each Triode Unit):**

Plate Voltage .....	100	250	volts
Grid Voltage .....	-1	-2	volts
Amplification Factor .....	100	100	
Plate Resistance (Approx.) .....	80000	62500	ohms
Transconductance .....	1250	1600	$\mu$ mhos
Plate Current .....	0.5	1.2	mA

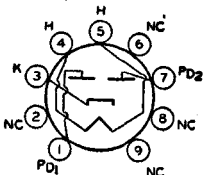

**9M**

**FULL-WAVE VACUUM RECTIFIER**

Miniature type used in power-supply of compact, audio equipment having moderate dc requirements. Outline 6G, Outlines section. Tube requires miniature nine-contact socket and may be mounted in any position. It is

**6CA4**

especially important that this tube, like other power-handling tubes, be adequately ventilated. Heater volts (ac/dc), 6.3; amperes, 1.

### Full-Wave Rectifier

#### MAXIMUM RATINGS (Design-Center Values):

Peak Inverse Plate Voltage .....	1000 max	volts
Peak Plate Current (Per Plate) .....	450 max	mA
AC Plate Supply Voltage (Per Plate, rms) with Capacitor Input to Filter .....		
to Filter .....	350 max	volts
DC Output Current .....	150 max	mA
Hot Switching Transient Plate Current (Per Plate) .....	#	
Peak Heater-Cathode Voltage:		
Heater negative with respect to cathode .....	500 max	volts

#### TYPICAL OPERATION with Capacitor Input to Filter:

AC Plate-to-Plate Supply Voltage (rms) .....	500	600	700	volts
Filter-Input Capacitor .....	50	50	50	$\mu$ F
Total Effective Plate Supply Impedance per Plate .....	150	200	240	ohms
DC Output Voltage at Input to Filter (Approx.) For dc output current of 150 mA .....	245	293	347	volts

# When capacitor-input circuits are used, a maximum peak current value per plate of 1 ampere during the initial cycles of the hot-switching transient should not be exceeded.

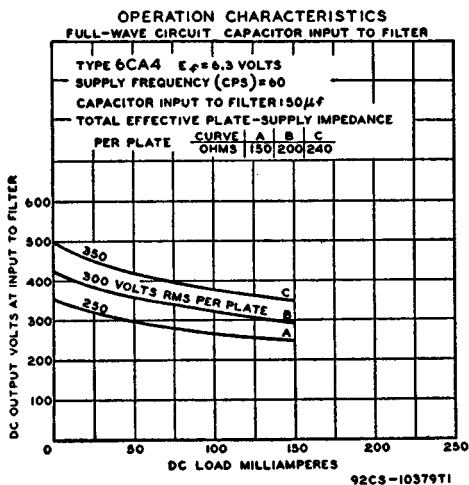

### BEAM POWER TUBE

Miniature type used in af power output stage of radio and television receivers. Outline 5D, **Outlines** section. Tube requires miniature seven-contact socket and may be operated in any position. Types 12CA5 and 25CA5

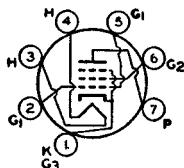

## 6CA5

Related types:  
12CA5, 25CA5

are identical with type 6CA5 except for the heater ratings, as shown below.

	6CA5	12CA5	25CA5	
Heater Voltage (ac/dc) .....	6.3	12.6	25	volts
Heater Current .....	1.2	0.6	0.3	ampere
Heater Warm-up Time (Average) .....	—	11	—	seconds

	6CA5	12CA5	25CA5	
<b>Peak Heater-Cathode Voltage:</b>				
Heater negative with respect to cathode ..	200 max	300*max	200 max	volts
Heater positive with respect to cathode ..	200*max	200*max	200*max	volts
* The dc component must not exceed 200 volts.				
° The dc component must not exceed 100 volts.				

**Class A<sub>1</sub> Amplifier**

**MAXIMUM RATINGS (Design-Center Values):**

Plate Voltage .....		130 max	volts
Grid-No.2 (Screen-Grid) Voltage .....		130 max	volts
Grid-No.1 (Control-Grid) Voltage, Positive-bias value .....		0 max	volts
Plate Dissipation .....		5 max	watts
Grid-No.2 Input .....		1.4 max	watts
Bulb Temperature (At hottest point) .....		180 max	°C

**TYPICAL OPERATION:**

Plate Voltage .....	110	125	volts
Grid-No.2 Voltage .....	110	125	volts
Grid-No.1 (Control-Grid) Voltage .....	-4	-4.5	volts
Peak AF Grid-No.1 Voltage .....	4	4.5	volts
Zero-Signal Plate Current .....	32	37	mA
Maximum-Signal Plate Current .....	31	36	mA
Zero-Signal Grid-No.2 Current (Approx.) .....	3.5	4	mA
Maximum-Signal Grid-No.2 Current (Approx.) .....	7.5	11	mA
Plate Resistance (Approx.) .....	16000	15000	ohms
Transconductance .....	8100	9200	μmhos
Load Resistance .....	3500	4500	ohms
Total Harmonic Distortion .....	5	6	per cent
Maximum-Signal Power Output .....	1.1	1.5	watts

**MAXIMUM CIRCUIT VALUES:**

Grid-No.1-Circuit Resistance:			
For fixed-bias operation .....		0.1 max	megohm
For cathode-bias operation .....		0.5 max	megohm

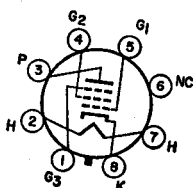

**POWER PENTODE**

Glass octal types used in the output stage of audio-frequency amplifiers. Maximum dimensions: over-all length, 4<sup>7</sup>/<sub>16</sub> inches; seated height, 3<sup>3</sup>/<sub>8</sub> inches; diameter, 1<sup>1</sup>/<sub>2</sub> inches. Tubes require octal eight-contact socket and may be

**6CA7  
6CA7/  
EL34**

**8E2**

mounted in any position.

Heater Voltage (ac/dc) .....	6.3	volts
Heater Current .....	1.5	amperes
<b>Peak Heater-Cathode Voltage:</b>		
Heater negative with respect to cathode .....	200 max	volts
Heater positive with respect to cathode .....	200 max	volts
<b>Direct Interelectrode Capacitances:</b>		
Grid No.1 to Plate .....	1	pF
Grid No.1 to Cathode, Heater, Grid No.2, and Grid No.3 .....	15.5	pF
Plate to Cathode, Heater, Grid No.2, and Grid No.3 .....	7.2	pF

**Class A<sub>1</sub> Amplifier**

**MAXIMUM RATINGS (Design-Center Values):**

Plate Voltages .....	800 max	volts
Grid-No.2 (Screen-Grid) Voltage .....	425 max	volts
Grid-No.2 Input .....	8 max	watts
Plate Dissipation .....	25 max	watts
Cathode Current .....	150 max	mA

**TYPICAL OPERATION:**

Plate Voltage .....	265	volts
---------------------	-----	-------

Grid-No.2 Voltage .....	250	volts
Grid-No.1 (Control-Grid) Voltage .....	-13.5	volts
Peak AF Grid-No.1 Voltage .....	12.3	volts
Zero-Signal Plate Current .....	100	mA
Zero-Signal Grid-No.2 Current .....	15	mA
Transconductance .....	11000	$\mu$ mhos
Plate Resistance .....	15000	ohms
Load Resistance .....	2000	ohms
Maximum-Signal Power Output .....	11	watts
Total Harmonic Distortion .....	10	per cent

**MAXIMUM CIRCUIT VALUES:**

Grid-No.1 Circuit Resistance:		
For cathode-bias resistance .....	0.7 max	megohm

**Push-Pull Class AB<sub>1</sub> Amplifier**

**MAXIMUM RATINGS:** (Same as for Class A<sub>1</sub> Amplifier)

**TYPICAL OPERATION** (Values are for two tubes):

Plate Supply Voltage .....	450	volts
Grid-No.2 Supply Voltage .....	450	volts
Cathode-Bias Resistor .....	232	ohms
Grid-No.2 Resistor .....	1000	ohms
Peak AF Grid-No.1 to Grid-No.1 Voltage .....	38.2	volts
Zero-Signal Plate Current .....	120	mA
Maximum-Signal Plate Current .....	143	mA
Zero-Signal Grid-No.2 Current .....	20	mA
Maximum-Signal Grid-No.2 Current .....	44	mA
Effective Load Resistance (Plate-to-plate) .....	6500	ohms
Total Harmonic Distortion .....	5.1	per cent
Maximum-Signal Power Output .....	40	watts

**BEAM POWER TUBE****6CB5A**

Glass octal type used as horizontal deflection amplifier in color television receivers. Outline 21B, **Outlines** section. This tube requires octal socket and may be mounted in any position.

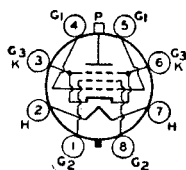
**8GD**

Heater Voltage (ac/dc) .....	6.3	volts
Heater Current .....	2.5	amperes
Peak Heater-Cathode Voltage:		
Heater negative with respect to cathode .....	200 max	volts
Heater positive with respect to cathode .....	200#max	volts
Direct Interelectrode Capacitances (Approx.):		
Grid No.1 to Plate .....	0.4	pF
Grid No.1 to Cathode, Heater, Grid No.2, and Grid No.3 .....	22	pF
Plate to Cathode, Heater, Grid No.2 and Grid No.3 .....	10	pF
Transconductance* .....	8800	$\mu$ mhos
Mu-Factor, Grid No.2 to Grid No.1* .....	3.8	

# The dc component must not exceed 100 volts.

\* For plate and grid No.2 volts, 175; grid-No.1 volts, -30; plate mA, 90; grid-No.2 mA, 6.

**Horizontal Deflection Amplifier**

For operation in a 525-line, 30-frame system

**MAXIMUM RATINGS** (Design-Maximum Values):

DC Plate Voltage .....	880 max	volts
Peak Positive-Pulse Plate Voltage# .....	6800 max	volts
Peak Negative-Pulse Plate Voltage .....	-1650 max	volts
DC Grid-No.2 (Screen-Grid) Voltage .....	220 max	volts
DC Grid-No.1 (Control-Grid) Voltage .....	-55 max	volts
Peak Negative-Pulse Grid-No.1 Voltage .....	-220 max	volts
Peak Cathode Current .....	850 max	mA
Average Cathode Current .....	240 max	mA

Grid-No.2 Input .....	4 max	watts
Plate Dissipation† .....	26 max	watts
Bulb Temperature (At hottest point) .....	220 max	°C

**MAXIMUM CIRCUIT VALUE:**

Grid-No.1-Circuit Resistance ..... 0.47 max megohm

# The duration of the voltage pulse must not exceed 15 per cent of one horizontal scanning cycle. In a 525-line, 30-frame system, 15 per cent of one horizontal scanning cycle is 10 microseconds.

† An adequate bias resistor or other means is required to protect the tube in the absence of excitation.

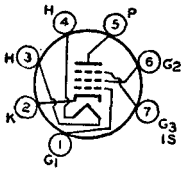

**7CM**

**SHARP-CUTOFF PENTODE**

Miniature types used in television receivers as intermediate-frequency amplifier at frequencies up to about 45 megacycles per second and as rf amplifier in vhf television tuners. Tubes feature very high transconductance

**6CB6**  
**6CB6A**  
Related types:  
3CB6, 4CB6

combined with low interelectrode capacitance values, and are provided with separate base pins for grid No.3 and the cathode to permit the use of an unbypassed cathode resistor to minimize the effects of regeneration. Type 6CB6A has a controlled heater warm-up time for use in television receivers employing series-connected heater strings. Outline 5C, **Outlines** section. Tubes require miniature seven-contact socket and may be mounted in any position. For typical operation as a resistance-coupled amplifier, refer to **Resistance-Coupled Amplifier** section. Types 3CB6, 4CB6, and 6CB6 are identical with type 6CB6A except for the heater ratings, as shown below.

	3CB6	4CB6	6CB6	6CB6A	
Heater Voltage (ac/dc) .....	3.15	4.2	6.3	6.3	volts
Heater Current .....	0.6	0.45	0.3	0.3	ampere
Heater Warm-up Time (Average) ...	11	11	—	11	seconds
<b>Peak Heater-Cathode Voltage:</b>					
Heater negative with respect to cathode .....	300 max	300*max	200 max	200 max	volts
Heater positive with respect to cathode .....	200*max	200*max	200*max	200*max	volts
<b>Direct Interelectrode Capacitances:</b>					
Grid No.1 to Plate .....			0.025 max	0.015 max	pF
Grid No.1 to Cathode, Heater, Grid No.2, Grid No.3, and Internal Shield .....			6.5	6.5	pF
Plate to Cathode, Heater, Grid No.2, Grid No.3, and Internal Shield .....			2	3	pF

- \* The dc component must not exceed 200 volts.
- ° The dc component must not exceed 100 volts.
- ▲ With external shield connected to cathode.

**Class A<sub>1</sub> Amplifier**

**MAXIMUM RATINGS (Design-Maximum Values):**

Plate Voltage .....	330 max	volts
Grid-No.3 (Suppressor-Grid) Voltage, Positive value .....	0 max	volts
Grid-No.2 (Screen-Grid) Voltage .....	See curve page 80	
Grid-No.2 Supply Voltage .....	330 max	volts
Grid-No.1 (Control-Grid) Voltage, Positive-bias value .....	0 max	volts
Plate Dissipation .....	2.3 max	watts
<b>Grid-No.2 Input:</b>		
For grid-No.2 voltages up to 165 volts .....	0.55 max	watt
For grid-No.2 voltages between 165 and 330 volts .....	See curve page 80	

**CHARACTERISTICS:**

Plate Supply Voltage .....	125	volts
Grid No.3 .....	Connected to cathode at socket	
Grid-No.2 Supply Voltage .....	125	volts
Cathode-Bias Resistor .....	56	ohms
Plate Resistance (Approx.) .....	0.28	megohm
Transconductance .....	8000	$\mu$ mhos
Grid-No.1 Voltage (Approx.) for plate current of 20 $\mu$ A .....	-6.5	volts
Grid-No.1 Voltage (Approx.) for plate current of 2.8 mA and cathode-bias resistor of 0 ohms .....	-3	volts
Plate Current .....	13	mA
Grid-No.2 Current .....	3.7	mA

## AVERAGE CHARACTERISTICS

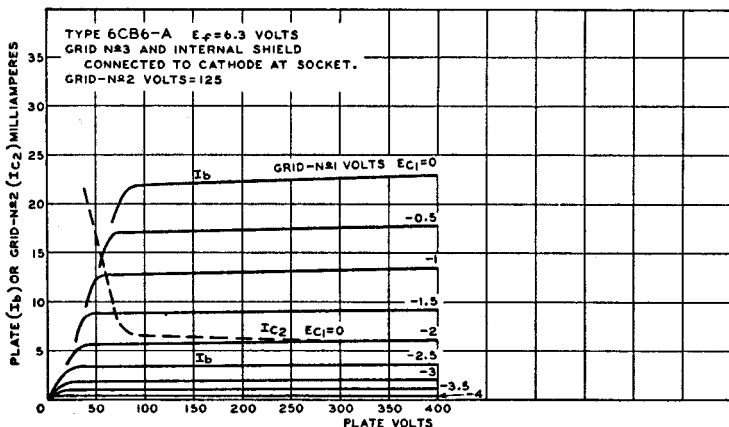

92CM-9854TI

**BEAM POWER TUBE****6CD6GA**

Related type:  
25CD6GB

Glass octal type used as horizontal deflection amplifier in high-efficiency deflection circuits of television receivers employing either transformer coupling or direct coupling to the deflection yoke. Outline 21B, **Outlines**

section. Tube requires octal socket. This type may be supplied with pins 1, 4, and 6 omitted. Vertical tube mounting is preferred but horizontal operation is permissible if pins No.2 and 7 are in vertical plane. Type 25CD6GB is identical with type 6CD6GA except for the heater ratings, as shown below.

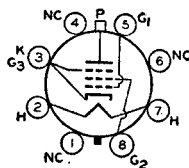
**5BT**

	6CD6GA	25CD6GB	
Heater Voltage (ac/dc) .....	6.3	25	volts
Heater Current .....	2.5	0.6	ampere
Heater Warm-up Time (Average) .....	—	11	seconds
Peak Heater-Cathode Voltage:			
Heater negative with respect to cathode .....	200 max	200 max	volts
Heater positive with respect to cathode .....	200-max	200-max	volts
Direct Interelectrode Capacitances (Approx.):			
Grid No.1 to Plate .....		1.1	pF
Grid No.1 to Cathode, Heater, Grid No.2, and Grid No.3 .....		22	pF
Plate to Cathode, Heater, Grid No.2, and Grid No.3 .....		8.5	pF
Transconductance° .....		7700	$\mu$ mhos
Plate Resistance (Approx.)° .....		7200	ohms
Mu-Factor, Grid No.2 to Grid No.1 .....		3.9	

△ The dc component must not exceed 100 volts.

° For plate and grid-No.2 volts, 175; grid-No.1 volts, -30; plate mA, 75; grid-No.2 mA, 5.5.



### Horizontal Deflection Amplifier

For operation in a 525-line, 30-frame system

**MAXIMUM RATINGS (Design-Center Values):**

DC Plate Voltage	700 max	volts
Peak Positive-Pulse Plate Voltage* (Absolute Maximum)	7000*max	volts
Peak Negative-Pulse Plate Voltage	-1500 max	volts
DC Grid-No.2 (Screen-Grid) Voltage	175 max	volts
Peak Negative-Pulse Grid-No.1 Voltage	700 max	mA
Peak Cathode Current	200 max	mA
Average Cathode Current	-200 max	volts
Plate Dissipation†	20 max	watts
Grid-No.2 Input	3 max	watts
Bulb Temperature (At hottest point)	225 max	°C

**MAXIMUM CIRCUIT VALUE:**

Grid-No.1-Circuit Resistance:	
For grid-resistor-bias operation	0.47 max megohm

\* The duration of the voltage pulse must not exceed 15 per cent of one horizontal scanning cycle. In a 525-line, 30-frame system, 15 per cent of one horizontal scanning cycle is 10 micro-seconds.

† Under no circumstances should this absolute value be exceeded.

‡ An adequate bias resistor or other means is required to protect the tube in the absence of excitation.

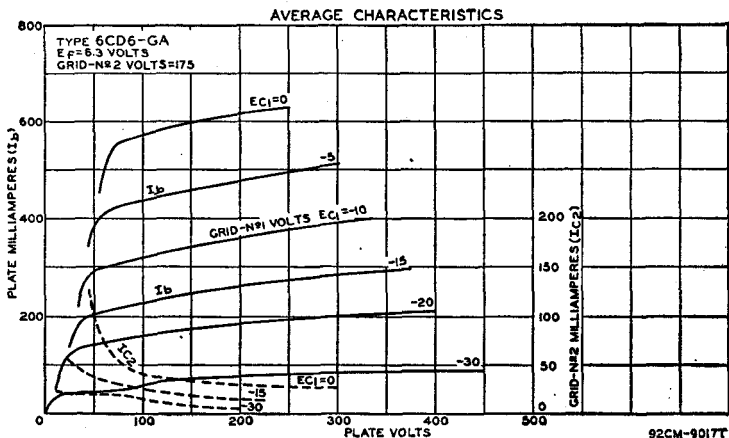
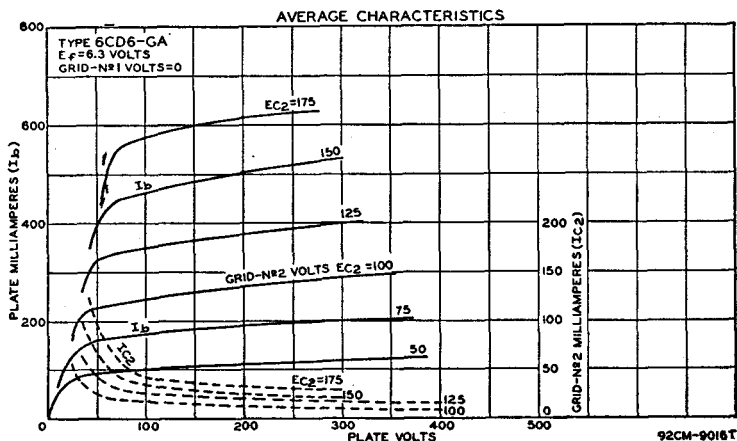

## SHARP-CUTOFF PENTODE

**6CE5**

Related type:  
3CE5

Miniature type used as rf and if amplifier in vhf television receivers employing series-connected heater strings. Outline 5C, **Outlines** section. Tube requires miniature seven-contact socket and may be operated in

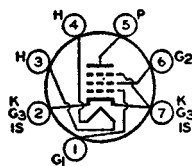
**7BD**

any position. Type 3CE5 is identical with type 6CE5 except for the heater ratings, as shown below.

	3CE5	6CE5	
Heater Voltage (ac/dc)	3.15	6.3	volts
Heater Current	0.6	0.3	ampere
Heater Warm-up Time (Average)	11	11	seconds
Peak Heater-Cathode Voltage:			
Heater negative with respect to cathode	200 max	200 max	volts
Heater positive with respect to cathode	200 max	200 max	volts
Direct Interelectrode Capacitances:			
Grid No.1 to Plate		0.03 max	pF
Grid No.1 to Cathode, Heater, Grid No.2, Grid No.3, and Internal Shield		6.5	pF
Plate to Cathode, Heater, Grid No.2, Grid No.3, and Internal Shield		1.9	pF

• The dc component must not exceed 100 volts.

Class A<sub>1</sub> Amplifier

## MAXIMUM RATINGS (Design-Center Values):

Plate Voltage	300 max	volts
Grid-No.2 (Screen-Grid) Voltage	150 max	volts
Grid-No.1 (Control-Grid) Voltage, Positive-bias value	0 max	volts
Grid-No.2 Input	0.5 max	watt
Plate Dissipation	2 max	watts
<b>CHARACTERISTICS:</b>		
Plate Voltage	125	volts
Grid-No.2 Voltage	125	volts
Grid-No.1 Supply Voltage	-1	volt
Grid-No.1 Resistor (Bypassed)	1	megohm
Plate Resistance (Approx.)	0.3	megohm
Transconductance	7600	μmhos
Grid-No.1 Voltage (Approx.) for plate current of 35 μA	-5	volts
Plate Current	11	mA
Grid-No.2 Current	2.3	mA

## SHARP-CUTOFF PENTODE

**6CF6**

Related type:  
3CF6

Miniature type used in television receivers as an intermediate-frequency amplifier at frequencies up to about 45 megacycles per second and as an rf amplifier in vhf television tuners. Because of its plate-current cutoff

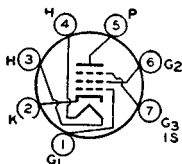
**7CM**

characteristic, this type is used in gain-controlled stages of video if amplifiers. This type is electrically similar to miniature type 6CB6. Outline 5C, **Outlines** section. Type 3CF6 is identical with type 6CF6 except for the heater ratings, as shown below.

	3CF6	6CF6	
Heater Voltage (ac/dc)	3.15	6.3	volts
Heater Current	0.6	0.3	ampere
Heater Warm-up Time (Average)	11	—	seconds

<b>Peak Heater-Cathode Voltage:</b>			
Heater negative with respect to cathode .....	300 max	200 max	volts
Heater positive with respect to cathode .....	200*max	200*max	volts
* The dc component must not exceed 100 volts.			

**CHARACTERISTICS:**

Plate Supply Voltage .....	125	volts
Grid No.3 .....	Connected to cathode at socket	
Grid-No.2 Supply Voltage .....	125	volts
Cathode-Bias Resistor .....	56	ohms
Plate Resistance (Approx.) .....	0.3	megohm
Transconductance .....	7800	μmhos
Grid-No.1 Voltage (Approx.) for plate current of 20 μA .....	-6	volts
Grid-No.1 Voltage (Approx.) for plate current of 2.2 mA and cathode-bias resistor of 0 ohms .....	-3	volts
Plate Current .....	12.5	mA
Grid No.2 Current .....	3.7	mA

Refer to type 6FQ7/6CG7

**6CG7**

**MEDIUM-MU TRIODE—  
SHARP-CUTOFF PENTODE**

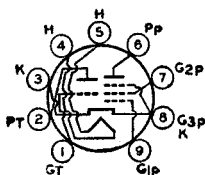

**9GF**

Miniature type used as combined oscillator and mixer tube in television receivers utilizing an intermediate frequency in the order of 40 megacycles per second. When used in an AM/FM receiver, the triode unit is used as an

**6CG8A**

Related type:  
5CG8

oscillator for both sections. In the AM section, the pentode unit is used as a high-gain pentode mixer; in the FM section, the pentode unit is used either as a pentode mixer or as a triode-connected mixer depending on signal-to-noise considerations. This type has a controlled heater warm-up time for use in television receivers employing series-connected heater strings. Outline 6B, **Outlines** section. Tube requires miniature nine-contact socket and may be mounted in any position. Type 5CG8 is identical with type 6CG8A except for the heater ratings. These types are electrically identical with miniature type 6X8 except for interelectrode capacitances.

	5CG8	6CG8A	
Heater Voltage (ac/dc) .....	4.7	6.3	volts
Heater Current .....	0.6	0.45	ampere
Heater Warm-up Time (Average) .....	11	11	seconds
<b>Peak Heater-Cathode Voltage:</b>			
Heater negative with respect to cathode .....	200 max	200 max	volts
Heater positive with respect to cathode .....	200*max	200*max	volts
<b>Direct Interelectrode Capacitances:</b>			
<b>Triode Unit:</b>			
Grid to Plate .....	1.5	1.5	pF
Grid to Cathode, Heater, and Pentode Grid No.3 .....	2	2.4	pF
Plate to Cathode, Heater, and Pentode Grid No.3 .....	0.5	1	pF
<b>Pentode Unit:</b>			
Grid No.1 to Plate .....	0.04 max	0.02 max	pF
Grid No.1 to Cathode, Heater, Grid No.2, and Grid No.3 .....	4.6	4.8	pF
Plate to Cathode, Heater, Grid No.2, and Grid No.3 .....	0.9	1.6	pF
Pentode Grid No.1 to Triode Plate .....	0.05 max	0.04 max	pF
Pentode Plate to Triode Plate .....	0.05 max	0.008 max	pF
Heater to Cathode .....	6.5	6.5*	pF

- \* The dc component must not exceed 100 volts.
- \* With external shield connected to cathode, except as noted.
- \* With external shield connected to plate.

## POWER PENTODE

**6CL6**

Miniature type used in output stage of video amplifier of television receivers and as wide-band amplifier tube in industrial and laboratory equipment. Outline 6E, **Outlines** section. Tube requires miniature nine-contact socket and may be mounted in any position.

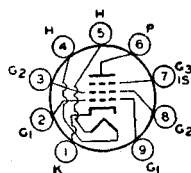
**9BV**

Heater Voltage (ac/dc) .....	6.3	volts
Heater Current .....	0.65	ampere
Peak Heater-Cathode Voltage:		
Heater negative with respect to cathode .....	100 max	volts
Heater positive with respect to cathode .....	100 max	volts
Direct Interelectrode Capacitances (Approx.):		
Grid No.1 to Plate .....	0.12	pF
Grid No.1 to Cathode, Heater, Grid No.2, Grid No.3, and Internal Shield .....	11	pF
Plate to Cathode, Heater, Grid No.2, Grid No.3, and Internal Shield .....	5.5	pF

**Class A<sub>1</sub> Amplifier****MAXIMUM RATINGS (Design-Center Values):**

Plate Voltage .....	300 max	volts
Grid-No.3 (Suppressor-Grid) Voltage, Positive Value .....	0 max	volts
Grid-No.2 (Screen-Grid) Supply Voltage .....	300 max	volts
Grid-No.2 Voltage .....	150 max	volts
Grid-No.1 (Control-Grid) Voltage:		
Negative-bias value .....	-50 max	volts
Positive-bias value .....	0 max	volts
Plate Dissipation .....	7.5 max	watts
Grid-No.2 Input .....	1.7 max	watts
Bulb Temperature (At hottest point) .....	200 max	°C

**TYPICAL OPERATION:**

Plate Voltage .....	250	volts
Grid No.3 .....	Connected to cathode at socket	
Grid-No.2 Voltage .....	150	volts
Grid-No.1 Voltage .....	-3	volts
Peak AF Grid-No.1 Voltage .....	3	volts
Zero-Signal Plate Current .....	30	mA
Maximum-Signal Plate Current .....	31	mA
Zero-Signal Grid-No.2 Current .....	7	mA
Maximum-Signal Grid-No.2 Current .....	7.2	mA
Plate Resistance (Approx.) .....	0.09	megohm
Transconductance .....	11000	μmhos
Grid-No.1 Voltage (Approx.) for plate current of 10 μA .....	-14	volts
Load Resistance .....	7500	ohms
Total Harmonic Distortion .....	8	per cent
Maximum-Signal Power Output .....	2.8	watts

**TYPICAL OPERATION IN 4-MC-BANDWIDTH VIDEO****AMPLIFIER:**

Plate Supply Voltage .....	300	volts
Grid No.3 .....	Connected to cathode at socket	
Grid-No.2 Supply Voltage .....	300	volts
Grid-No.1 Bias Voltage .....	-2	volts
Grid-No.1 Signal Voltage (Peak to Peak) .....	3	volts
Grid-No.2 Resistor .....	24000	ohms
Grid-No.1 Resistor .....	0.1	megohm
Load Resistor .....	3900	ohms
Zero-Signal Plate Current .....	30	mA
Zero-Signal Grid-No.2 Current .....	7.0	mA
Voltage Output (Peak to Peak) .....	132	volts

**MAXIMUM CIRCUIT VALUES:**

Grid-No.1 Circuit Resistance:		
For fixed-bias operation .....	0.1 max	megohm
For cathode-bias operation .....	0.5 max	megohm

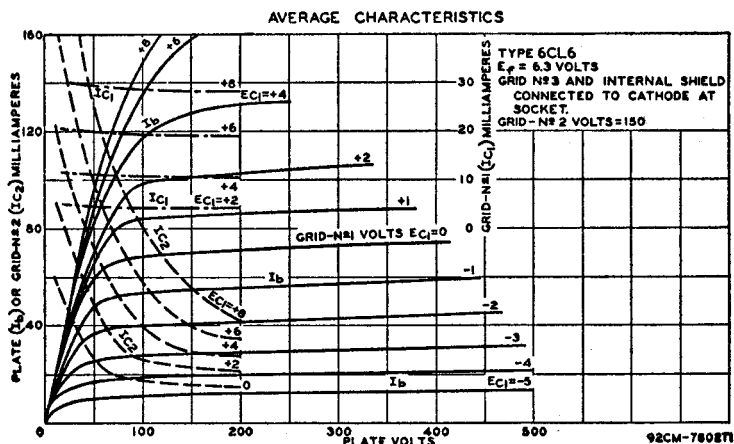

**MEDIUM-MU TRIODE—  
SHARP-CUTOFF TETRODE**

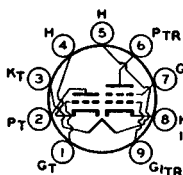

**9FX**

Miniature type used as combined vhf oscillator and mixer in television receivers employing series-connected heater strings. Outline 6B, Outlines section. This tube requires miniature nine-contact socket and may be

mounted in any position. For maximum ratings as class  $A_1$  amplifier, see type 6U8A. Types 5CL8A and 19CL8A are identical with type 6CL8A except for the heater ratings, as shown below.

**6CL8A**  
 Related types:  
 5CL8A, 19CL8A

	5CL8A	6CL8A	19CL8A	
Heater Voltage (ac/dc) .....	4.7	6.3	18.9	volts
Heater Current .....	0.6	0.45	0.15	ampere
Heater Warm-up Time (Average) .....	11	11	11	seconds
Heater negative with respect to cathode ..	200	200	200	volts
Heater positive with respect to cathode ..	200 <sup>a</sup>	200 <sup>a</sup>	200 <sup>a</sup>	volts

<sup>a</sup> The dc component must not exceed 100 volts.

**Class  $A_1$  Amplifier**

**CHARACTERISTICS:**

	Triode Unit	Tetrode Unit	
Plate Supply Voltage .....	125	125	volts
Grid-No.2 (Screen-Grid) Voltage .....	—	125	volts
Grid-No.1 Voltage .....	-1	-1	volt
Amplification Factor .....	40	—	
Plate Resistance (Approx.) .....	0.005	0.2	megohm
Transconductance .....	8000	6500	$\mu$ mhos
Grid-No.1 Voltage (Approx.) for plate current of 20 $\mu$ A ..	-9	-9	volts
Plate Current .....	14	12	mA
Grid-No.2 Current .....	—	4	mA

**MAXIMUM CIRCUIT VALUES:**

Grid-No.1-Circuit Resistance:			
For fixed-bias operation .....	0.5 max	0.25 max	megohm
For cathode-bias operation .....	1 max	1 max	megohm

## BEAM POWER TUBE

## 6CM6

Miniature type used as vertical deflection amplifier in television receivers and as audio power amplifier in radio and television receivers. Outline 6E, **Outlines** section. Tube requires miniature nine-contact socket and

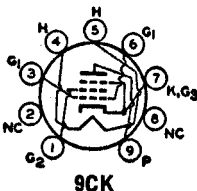

may be mounted in any position. For typical operation and maximum circuit values as class A<sub>1</sub> amplifier, refer to type 6V6GTA. For curves of average plate characteristics, refer to type 6AQ5A.

Heater Voltage (ac/dc) .....	6.3	volts
Heater Current .....	0.45	ampere
Peak Heater-Cathode Voltage:		
Heater negative with respect to cathode .....	200 max	volts
Heater positive with respect to cathode .....	200 max	volts
Amplification Factor* .....	9.8	
Plate Resistance (Approx.)* .....	1960	ohms
Transconductance* .....	5000	μmhos

\* The dc component must not exceed 100 volts.

\* Grid No.2 connected to plate; plate and grid-No.2 volts, 250; grid-No.1 volts, -12.5; plate and grid-No.2 mA, 49.5.

Class A<sub>1</sub> Amplifier

## MAXIMUM RATINGS (Design-Center Values):

Plate Voltage .....	315 max	volts
Grid-No.2 (Screen-Grid) Voltage .....	285 max	volts
Grid-No.2 Input .....	2 max	watts
Plate Dissipation .....	12 max	watts

## Vertical Deflection Amplifier

For operation in a 525-line, 30-frame system

MAXIMUM RATINGS (Design-Center Values):	Triode Connection*	Pentode Connection	
DC Plate Voltage .....	315 max	315 max	volts
Peak Positive-Pulse Plate Voltage† (Absolute Maximum) .....	2000 max	2000 max	volts
DC Grid-No.2 (Screen-Grid) Voltage .....	—	285 max	volts
Peak Negative-Pulse Grid-No.1 (Control-Grid) Voltage .....	-250 max	-250 max	volts
Peak Cathode Current .....	120 max	120 max	mA
Average Cathode Current .....	40 max	40 max	mA
Plate Dissipation .....	9 max	8 max	watts
Grid-No.2 Input .....	—	1.75 max	watts

## MAXIMUM CIRCUIT VALUES:

Grid-No.1-Circuit Resistance:		
For cathode-bias operation .....	2.2 max	2.2 max megohms

\* Grid No.2 connected to plate.

† The duration of the voltage pulse must not exceed 15 per cent of one vertical scanning cycle. In a 525-line, 30-frame system, 15 per cent of one vertical scanning cycle is 2.5 milliseconds.

▲ Under no circumstances should this absolute value be exceeded.

## MEDIUM-MU DUAL TRIODE

## 6CM7

Related type:  
8CM7

Miniature type used as combined vertical deflection oscillator and vertical deflection amplifier in television receivers employing series-connected heater strings. Unit No.1 is used as a conventional blocking oscillator in

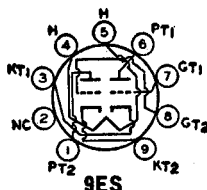

vertical deflection circuits, and unit No.2 as a vertical deflection amplifier. Outline 6E, **Outlines** section. Tube requires miniature nine-contact socket and may be

mounted in any position. Type 8CM7 is identical with type 6CM7 except for the heater ratings, as shown below.

	6CM7	8CM7	
Heater Voltage (ac/dc)	6.3	8.4	volts
Heater Current	0.6	0.45	ampere
Heater Warm-up Time (Average)	11	11	seconds
Peak Heater-Cathode Voltage:			
Heater negative with respect to cathode	200 max	200 max	volts
Heater positive with respect to cathode	200 $\Delta$ max	200 $\Delta$ max	volts
Direct Interelectrode Capacitances (Approx.):	Unit No.1	Unit No.2	
Grid to Plate	3.8	3	pF
Grid to Cathode and Heater	2	3.5	pF
Plate to Cathode and Heater	0.5	0.4	pF

$\Delta$  The dc component must not exceed 100 volts.

### Class A<sub>1</sub> Amplifier

CHARACTERISTICS:	Unit No.1	Unit No.2	
Plate Voltage	200	250	volts
Grid Voltage	-7	-8	volts
Amplification Factor	21	18	
Plate Resistance (Approx.)	10500	4100	ohms
Transconductance	2000	4400	$\mu$ mhos
Grid Voltage (Approx.) for plate current of 10 $\mu$ A	-14	—	volts
Plate Current	5	20	mA
Plate Current for grid voltage of -10 volts	1	—	mA

### Vertical Deflection Oscillator and Amplifier

For operation in a 525-line, 30-frame system

MAXIMUM RATINGS (Design-Maximum Values):	Unit No.1	Unit No.2	
DC Plate Voltage	550 max	550 max	volts
Peak Positive-Pulse Plate Voltage#	—	2200 max	volts
Peak Negative-Pulse Grid Voltage	-220 max	-220 max	volts
Peak Cathode Current	77 max	77 max	mA
Average Cathode Current	17 max	22 max	mA
Plate Dissipation	1.45 max	6 max	watts

#### MAXIMUM CIRCUIT VALUES:

Grid-Circuit Resistance:		
For fixed-bias operation	2.2 max	1.0 max megohms
For cathode-bias operation	2.2 max	2.5 max megohms
For grid-resistor-bias operation	2.2 max	— megohms

# The duration of the voltage pulse must not exceed 15 per cent of one vertical scanning cycle. In a 525-line, 30-frame system, 15 per cent of one vertical scanning cycle is 2.5 milliseconds.

#### AVERAGE CHARACTERISTICS

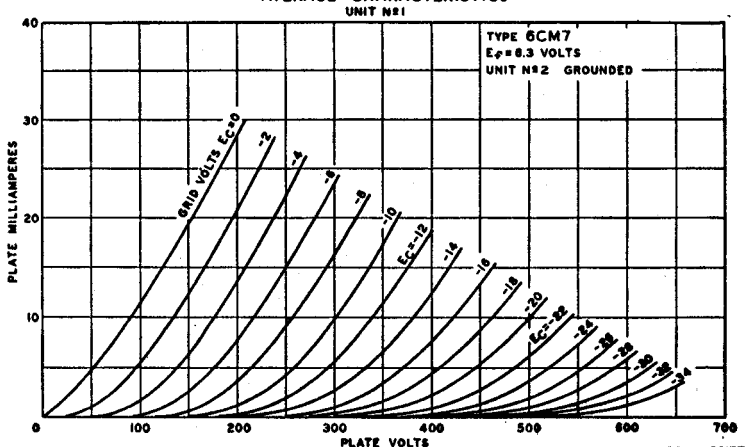

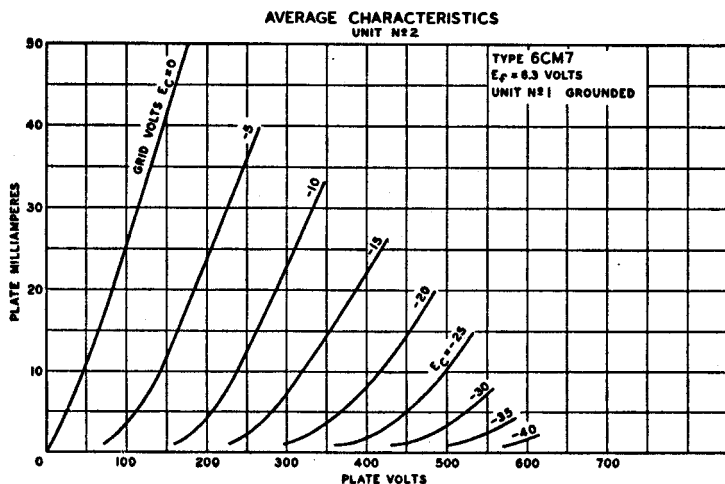

### TWIN DIODE— HIGH-MU TRIODE

## 6CN7

Related type:  
8CN7

Miniature type used as combined horizontal phase detector and reactance tube in television receivers employing series-connected heater strings. The triode unit is used in sync-separator, sync-amplifier, or au-

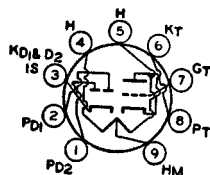

9EN

dio amplifier circuits. Outline 6B, **Outlines** section. Tube requires miniature nine-contact socket and may be mounted in any position. For typical operation of triode unit as resistance-coupled amplifier, refer to **Resistance-Coupled Amplifier** section. Type 8CN7 is identical with type 6CN7 except for the heater ratings, as shown below.

	6CN7	8CN7	
Heater Voltage (ac/dc):			
Series .....	6.3	8.4	volts
Parallel .....	3.15	4.2	volts
Heater Current:			
Series .....	0.3	0.225	ampere
Parallel .....	0.6	0.45	ampere
Heater Warm-up Time (Average) .....	11	11	seconds
Peak Heater-Cathode Voltage:			
Heater negative with respect to cathode .....	200 max	200 max	volts
Heater positive with respect to cathode .....	200*max	200*max	volts

\* The dc component must not exceed 100 volts.

### Triode Unit as Class A<sub>1</sub> Amplifier

#### MAXIMUM RATINGS (Design-Maximum Values):

Plate Voltage .....	330 max	volts
Grid Voltage, Positive-bias value .....	0 max	volts
Plate Dissipation .....	1.1 max	watt

#### CHARACTERISTICS:

Plate Voltage .....	100	250	volts
Grid Voltage .....	-1	-3	volts
Amplification Factor .....	70	70	
Plate Resistance (Approx.) .....	54000	58000	ohms
Transconductance .....	1300	1200	$\mu$ mhos
Plate Current .....	0.8	1	mA



Diode Units

MAXIMUM RATINGS (Design-Maximum Values):

Plate Current (Each Unit) .....	5.5 max	mA
---------------------------------	---------	----

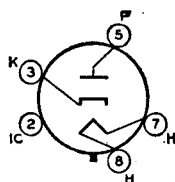

4CG

HALF-WAVE VACUUM RECTIFIER

Octal type used as damper tube in horizontal-deflection circuits of television receivers. Outline 13G, **Outlines** section. Tube requires octal socket and may be mounted in any position.

**6CQ4**

Socket terminals 1, 2, 4, and 6 should not be used as tie points. It is especially important that this tube, like other power-handling tubes, be adequately ventilated. Heater volts (ac/dc), 6.3; amperes, 1.6.

Damper Service

For operation in a 525-line, 30-frame system

MAXIMUM RATINGS (Design-Maximum Values):

Peak Inverse Plate Current* .....	5500 max	volts
Peak Plate Current .....	1200 max	mA
DC Plate Current .....	190 max	mA
Plate Dissipation .....	6.5 max	watts
Peak Heater-Cathode Voltage:		
Heater negative with respect to cathode .....	5500 <sup>max</sup>	volts
Heater positive with respect to cathode .....	300 <sup>max</sup>	volts

CHARACTERISTICS, Instantaneous Value:

Tube Voltage Drop for plate current of 250 mA .....	25	volts
---	----	-------

\* The duration of the voltage pulse must not exceed 15 per cent of one horizontal scanning cycle. In a 525-line, 30-frame system, 15 per cent of one horizontal scanning cycle is 10 microseconds.

• The dc component must not exceed 900 volts.

□ The dc component must not exceed 100 volts.

MEDIUM-MU TRIODE—  
SHARP-CUTOFF TETRODE

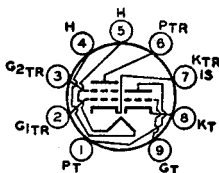

9GE

Miniature type used in a wide variety of applications in color and black-and-white television receivers employing series-connected heater strings. Especially useful as combined vhf oscillator and mixer in tuners of

**6CQ8**

Related type:  
5CQ8

television receivers utilizing an intermediate frequency in the order of 40 megacycles per second. The tetrode unit is used as a mixer, video if amplifier, or sound if amplifier tube. The triode unit is used in vhf oscillator, phase-splitter, sync-clipper, sync-separator, and rf amplifier circuits. Outline 6B, **Outlines** section. Tube requires miniature nine-contact socket and may be mounted in any position. Type 5CQ8 is identical with type 6CQ8 except for the heater ratings, as shown below.

Heater Voltage (ac/dc) .....	5CQ8	6CQ8	
Heater Current .....	4.7	6.3	volts
Heater Warm-up Time (Average) .....	0.6	0.45	ampere
Peak Heater-Cathode Voltage:	11	11	seconds
Heater negative with respect to cathode .....	200 max	200 max	volts
Heater positive with respect to cathode .....	200 <sup>max</sup>	200 <sup>max</sup>	volts

▲ The dc component must not exceed 100 volts.

Direct Interelectrode Capacitances:	Without External Shield	With External Shield*	
<b>Triode Unit:</b>			
Grid to Plate .....	1.8	1.8	pF
Grid to Cathode and Heater .....	2.7	2.7	pF
Plate to Cathode and Heater .....	0.4	1.2	pF
<b>Tetrode Unit:</b>			
Grid No.1 to Plate .....	0.019 max	0.015 max	pF
Grid No.1 to Cathode, Heater, Grid No.2 and Internal Shield .....	5.0	5.0	pF
Plate to Cathode, Heater, Grid No.2, and Internal Shield .....	2.5	3.3	pF
Tetrode Plate to Triode Plate .....	0.07 max	0.01 max	pF
Heater to Cathode (Each Unit) .....	3.0	3.0†	pF

\* With external shield connected to cathode of unit under test.  
† With external shield connected to ground.

### Class A<sub>1</sub> Amplifier

MAXIMUM RATINGS (Design-Maximum Values):	Triode Unit	Tetrode Unit	
Plate Voltage .....	330 max	330 max	volts
Grid-No.2 (Screen-Grid) Supply Voltage .....	—	330 max	volts
Grid-No.2 Voltage .....	—	See curve page 80	
Grid-No.1 (Control-Grid) Voltage, Positive-bias value ..	0 max	0 max	volts
Plate Dissipation .....	3.1 max	3.2 max	watts
<b>Grid-No.2 Input:</b>			
For grid-No.2 voltages up to 165 volts .....	—	0.7 max	watt
For grid-No.2 voltages between 165 and 330 volts ..	—	See curve page 80	
Grid Input .....	0.55 max	—	watt

### CHARACTERISTICS:

Plate-Supply Voltage .....	125	125	volts
Grid-No.2 Supply Voltage .....	—	125	volts
Grid-No.1 Voltage .....	—	—1	volts
Cathode-Bias Resistor .....	56	—	ohms
Amplification Factor .....	40	—	
Plate Resistance (Approx.) .....	5000	140000	ohms
Transconductance .....	8000	5800	$\mu$ mhos
Grid-No.1 Voltage (Approx.) for plate current of 100 $\mu$ A ..	—7	—7	volts
Plate Current .....	15	12	mA
Grid-No.2 Current .....	—	4.2	mA

### MAXIMUM CIRCUIT VALUES:

<b>Grid-No.1-Circuit Resistance:</b>			
For fixed-bias operation .....	0.5 max	0.25 max	megohm
For cathode-bias operation .....	1.0 max	1.0 max	megohm

## DIODE— REMOTE-CUTOFF PENTODE

# 6CR6

Related type:  
12CR6

Miniature type used as combined detector and audio amplifier in automobile and ac-operated radio receivers. The diode unit is used as an AM detector, and the pentode unit as an automatic-volume-controlled audio

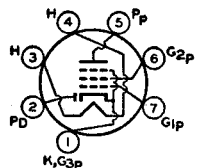

7EA

amplifier. Outline 5C, **Outlines** section. Tube requires miniature seven-contact socket and may be mounted in any position. Type 12CR6 is identical with type 6CR6 except for the heater ratings, as shown below.

	6CR6	12CR6	
Heater Voltage (ac/dc) .....	6.3	12.6	volts
Heater Current .....	0.3	0.15	ampere
<b>Peak Heater-Cathode Voltage:</b>			
Heater negative with respect to cathode .....	100 max	100 max	volts
Heater positive with respect to cathode .....	100 max	100 max	volts

**Pentode Unit as Class A<sub>1</sub> Amplifier**

**MAXIMUM RATINGS (Design-Center Values):**

Plate Voltage .....	300 max	volts
Grid-No.2 (Screen-Grid) Voltage .....	See curve page 80	
Grid-No.2 Supply Voltage .....	300 max	volts
Grid-No.1 (Control-Grid) Voltage, Positive-bias value .....	0 max	volts
Plate Dissipation .....	2.5 max	watts
Grid-No.2 Input:		
For grid-No.2 voltages up to 150 volts .....	0.3 max	watt
For grid-No.2 voltages between 150 and 300 volts .....	See curve page 80	

**CHARACTERISTICS:**

Plate Voltage .....	250	volts
Grid-No.2 Voltage .....	100	volts
Grid-No.1 Voltage .....	-2	volts
Plate Resistance (Approx.) .....	0.8	megohm
Transconductance .....	2200	μmhos
Plate Current .....	9.6	mA
Grid-No.2 Current .....	2.6	mA
Grid-No.1 Voltage (Approx.) for transconductance of 10 μmhos .....	-32	volts

**MAXIMUM CIRCUIT VALUES:**

Grid-No.1-Circuit Resistance:		
For fixed-bias operation .....	0.25 max	megohm
For cathode-bias operation .....	1.0 max	megohm

**Diode Unit**

**MAXIMUM RATING (Design-Center Value):**

Plate Current .....	1 max	mA
---------------------	-------	----

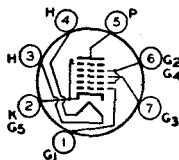

**PENTAGRID AMPLIFIER**

Miniature type used as a gated amplifier in television receivers. In such service, it may be used as a combined sync separator and sync clipper. Outline 5C, Outlines section. Tube requires miniature seven-contact socket

**6CS6**

Related types:  
3CS6, 4CS6

**7CH**

and may be mounted in any position. Types 3CS6 and 4CS6 are identical with type 6CS6 except for the heater ratings, as shown below.

	3CS6	4CS6	6CS6	
Heater Voltage (ac/dc) .....	3.15	4.2	6.3	volts
Heater Current .....	0.6	0.45	0.3	ampere
Heater Warm-up Time (Average) .....	11	11	—	seconds
Peak Heater-Cathode Voltage:				
Heater negative with respect to cathode ..	200 max	200 max	200 max	volts
Heater positive with respect to cathode ..	200*max	200*max	200*max	volts

\* The dc component must not exceed 100 volts.

**Class A<sub>1</sub> Amplifier**

**CHARACTERISTICS:**

Plate Voltage .....	100	100	volts
Grids-No.2-and-No.4 Voltage .....	30	30	volts
Grid-No.3 Voltage .....	-1	0	volt
Grid-No.1 Voltage .....	0	-1	volt
Plate Resistance (Approx.) .....	0.7	1	megohm
Grid-No.3-to-Plate Transconductance .....	1500	—	μmhos
Grid-No.1-to-Plate Transconductance .....	—	1100	μmhos
Plate Current .....	0.8	1.0	mA
Grids-No.2-and-No.4 Current .....	5.5	1.3	mA
Grid-No.3 Voltage (Approx.) for plate current of 50 μA .....	-2.2	—	volts
Grid-No.1 Voltage (Approx.) for plate current of 50 μA .....	—	-2.5	volts

**Gated Amplifier Service**

**MAXIMUM RATINGS (Design-Center Values):**

Plate Voltage .....	300 max	volts
---------------------	---------	-------

Grids-No.2-and-No.4 Supply Voltage .....	300 max	volts
Grids-No.2-and-No.4 Voltage .....	See curve page 80	
Plate Dissipation .....	1 max	watt
Grids-No.2-and-No.4 Input:		
For grids-No.2-and-No.4 voltages up to 150 volts .....	1 max	watt
For grids-No.2-and-No.4 voltages between 150 and 300 volts .....	See curve page 80	
Cathode Current .....	14 max	mA

**MAXIMUM CIRCUIT VALUES:**

Grid-No.1-Circuit Resistance .....	0.47 max	megohm
Grid-No.3-Circuit Resistance .....	2.2 max	megohms

**MEDIUM-MU DUAL TRIODE****6CS7**Related type:  
8CS7

Miniature type used as combined vertical deflection oscillator and vertical deflection amplifier in television receivers employing series-connected heater strings. Unit No.1 is used as a conventional blocking oscillator in

vertical deflection circuits, and unit No.2 as a vertical deflection amplifier. Outline 6E, **Outlines** section. Tube requires miniature nine-contact socket and may be mounted in any position. Type 8CS7 is identical with type 6CS7 except for the heater ratings, as shown below.

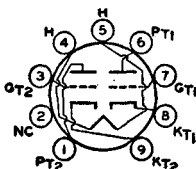
**9EF**

Heater Voltage (ac/dc) .....	6CS7	8CS7	
Heater Current .....	6.3	8.4	volts
Heater Warm-up Time (Average) .....	0.6	0.45	ampere
Peak Heater-Cathode Voltage:	11	11	seconds
Heater negative with respect to cathode .....	200 max	200 max	volts
Heater positive with respect to cathode .....	200*max	200*max	volts

\* The dc component must not exceed 100 volts.

**Class A<sub>1</sub> Amplifier****CHARACTERISTICS:**

	Unit No.1	Unit No.2	
Plate Voltage .....	250	250	volts
Grid Voltage .....	-8.5	-10.5	volts
Amplification Factor .....	17	15.5	
Plate Resistance (Approx.) .....	7700	3450	ohms
Transconductance .....	2200	4500	μmhos
Grid Voltage (Approx.) for plate current of 10 μA ..	-24	—	volts
Grid Voltage (Approx.) for plate current of 50 μA ..	—	-22	volts
Plate Current .....	10.5	19	mA
Plate Current for grid voltage of -16 volts .....	—	3	mA

**Vertical Deflection Oscillator and Amplifier**

For operation in a 525-line, 30-frame system

**MAXIMUM RATINGS (Design-Center Values):**

	Unit No.1 Oscillator	Unit No.2 Amplifier	
DC Plate Voltage .....	500 max	500 max	volts
Peak Positive-Pulse Plate Voltage† (Absolute Maximum) ..	—	2200*max	volts
Peak Negative-Pulse Grid Voltage .....	-400 max	-250 max	volts
Peak Cathode Current .....	70 max	105 max	mA
Average Cathode Current .....	20 max	30 max	mA
Plate Dissipation .....	1.25 max	6.5 max	watts

**MAXIMUM CIRCUIT VALUES:**

Grid-Circuit Resistance .....	2.2 max	2.2 max	megohms
-------------------------------	---------	---------	---------

† The duration of the voltage pulse must not exceed 15 per cent of one vertical scanning cycle. In a 525-line, 30-frame system, 15 per cent of one vertical scanning cycle is 2.5 milliseconds.

\* Under no circumstances should this absolute value be exceeded.

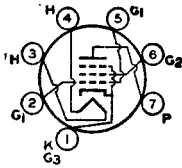

7CV

**BEAM POWER TUBE**

Miniature type used in the audio output stage of television receivers. Outline 5D, Outlines section. Tube requires miniature seven-contact socket and may be mounted in any position.

**6CU5**

Related types:  
12CU5/12C5, 17CU5

Types 12CU5/12C5 and 17CU5 are identical with type 6CU5 except for the heater ratings, as shown below.

	6CU5	12CU5/ 12C5	17CU5	
Heater Voltage (ac/dc)	6.3	12.6	16.8	volts
Heater Current	1.2	0.6	0.45	ampere
Heater Warm-up Time (Average)	—	11	11	seconds
<b>Peak Heater-Cathode Voltage:</b>				
Heater negative with respect to cathode	200 max	200 max	200 max	volts
Heater positive with respect to cathode	200 max	200 max	200 max	volts
<b>Direct Interelectrode Capacitances (Approx.):</b>				
Grid No.1 to Plate			0.6	pF
Grid No.1 to Cathode, Heater, Grid No.2, and Grid No.3			13	pF
Plate to Cathode, Heater, Grid No.2, and Grid No.3			8.5	pF

■ The dc component must not exceed 100 volts.

**Class A<sub>1</sub> Amplifier**

**MAXIMUM RATINGS (Design-Maximum Values):**

Plate Voltage	150 max	volts
Grid-No.2 (Screen-Grid) Voltage	130 max	volts
Grid-No.1 (Control-Grid) Voltage, Positive-bias value	0 max	volts
Plate Dissipation	7 max	watts
Grid-No.2 Input	1.4 max	watts
Bulb Temperature (At hottest point)	220 max	°C

**TYPICAL OPERATION:**

Plate Voltage	120	volts
Grid-No.2 Voltage	110	volts
Grid-No.1 Voltage	-8	volts
Peak AF Grid-No.1 Voltage	8	volts
Zero-Signal Plate Current	49	mA
Maximum-Signal Plate Current	50	mA
Zero-Signal Grid-No.2 Current	4	mA
Maximum-Signal Grid-No.2 Current	8.5	mA
Plate Resistance (Approx.)	10000	ohms
Transconductance	7500	μmhos
Load Resistance	2500	ohms
Total Harmonic Distortion	10	per cent
Maximum-Signal Power Output	2.3	watts

**MAXIMUM CIRCUIT VALUES:**

<b>Grid-No.1-Circuit Resistance:</b>		
For fixed-bias operation		0.1 max megohm
For cathode-bias operation		0.5 max megohm

Refer to type 6BQ6GTB/6CU6

**6CU6**

**MEDIUM-MU TRIODE—  
SHARP-CUTOFF PENTODE**

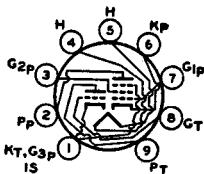

9GM

Miniature type used in a wide variety of applications in color and black-and-white television receivers employing series-connected heater strings. The pentode unit is used as an amplifier, a video amplifier, an agc am-

**6CU8**

plifier, and a reactance tube. The triode unit is used in low-frequency oscillator, sync-separator, sync-clipper, and phase-splitter circuits. Outline 6B, **Outlines** section. Tube requires miniature nine-contact socket and may be mounted in any position.

Heater Voltage (ac/dc) .....	6.3	volts
Heater Current .....	0.45	ampere
Peak Heater-Cathode Voltage:		
Heater negative with respect to cathode .....	200 max	volts
Heater positive with respect to cathode .....	200*max	volts
Direct Interelectrode Capacitances:		
Triode Unit:		
Grid to Plate .....	1.6	pF
Grid to Cathode, Heater, Pentode Grid No.3, and Internal Shield .....	1.9	pF
Plate to Cathode, Heater, Pentode Grid No.3 and Internal Shield .....	1.6	pF
Pentode Unit:		
Grid No.1 to Plate .....	0.025 max	pF
Grid No.1 to Cathode, Heater, Grid No.2, Grid No.3, Triode Cathode, and Internal Shield .....	7	pF
Plate to Cathode, Heater, Grid No.2, Grid No.3, Triode Cathode, and Internal Shield .....	2.4	pF
Pentode Grid No.1 to Triode Plate .....	0.03 max	pF
Pentode Plate to Triode Plate .....	0.07 max	pF

\* The dc component must not exceed 100 volts.

### Class A<sub>1</sub> Amplifier

#### MAXIMUM RATINGS (Design-Maximum Values):

	Triode Unit	Pentode Unit	
Plate Voltage .....	330 max	330 max	volts
Grid-No.2 Supply Voltage .....	—	330 max	volts
Grid-No.2 (Screen-Grid) Voltage .....	—	See curve page 80	
Grid-No.1 (Control-Grid) Voltage, Positive-bias value .....	0 max	0 max	volts
Plate Dissipation .....	2.8 max	2.3 max	watts
Grid-No.2 Input:			
For grid-No.2 voltages up to 165 volts .....	—	0.55 max	watt
For grid-No.2 voltages between 165 and 330 volts .....	—	See curve page 80	

#### CHARACTERISTICS:

Plate Supply Voltage .....	125	125	volts
Grid-No.2 Supply Voltage .....	—	125	volts
Grid-No.1 Voltage .....	-1	—	volts
Cathode-Bias Resistor .....	—	56	ohms
Amplification Factor .....	24	—	
Plate Resistance (Approx.) .....	4100	17000	ohms
Transconductance .....	5800	7800	μmhos
Grid-No.1 Voltage (Approx.) for plate current of 20 μA .....	-19	-8	volts
Plate Current .....	17	12	mA
Plate Current for grid-No.1 voltage of -3 volts and cathode-bias resistor of 0 ohms .....	—	-1.6	mA
Grid-No.2 Current .....	—	3.8	mA

### HIGH-MU TRIODE

Nuvistor type used as a grounded-cathode, neutralized rf amplifier in vhf tuners of television and FM receivers. Outline 1, **Outlines** section. Tube requires nuvistor socket and may be operated in any position.

## 6CW4

Related types:  
2CW4, 13CW4

Types 2CW4 and 13CW4 are identical with type 6CW4 except for the heater ratings, as shown below.

Heater Voltage (ac/dc) .....	2CW4	6CW4	13CW4	
Heater Current .....	2.1	6.3	13.5	volts
Heater Warm-up Time (Average) .....	0.45	0.135	0.06	ampere
	8	—	—	seconds

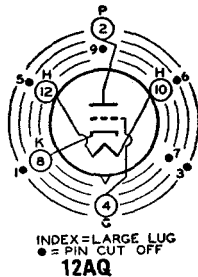

12AQ

Peak Heater-Cathode Voltage:	2CW4	6CW4	13CW4	
Heater negative with respect to cathode ..	100 max	100 max	100 max	volts
Heater positive with respect to cathode ..	100 max	100 max	100 max	volts
Direct Interelectrode Capacitances (Approx.) .....				
Grid to Plate .....			0.92	pF
Grid to Cathode, Heater, and Shell .....			4.3	pF
Plate to Cathode, Heater, and Shell .....			1.8	pF
Plate to Cathode .....			0.18	pF
Heater to Cathode .....			1.6	pF

**Class A<sub>1</sub> Amplifier**

**MAXIMUM RATINGS (Design-Maximum Values):**

Plate Supply Voltage .....	300° max	volts
Plate Voltage .....	135 max	volts
Grid Voltage:		
Negative-bias value .....	55 max	volts
Peak positive value .....	0 max	volts
Plate Dissipation .....	1.5 max	watt
Cathode Current .....	15 max	mA

**CHARACTERISTICS AND TYPICAL OPERATION:**

Plate Supply Voltage .....	110	70	volts
Grid Supply Voltage .....	0	0	volts
Cathode-Bias Resistor .....	130	—	ohms
Grid Resistor .....	—	47000	ohms
Amplification Factor .....	65	68	
Plate Resistance (Approx.) .....	6600	5440	ohms
Transconductance .....	9800	12500	μmhos
Grid Voltage (Approx.) for plate current of 10 μA ..	-4	—	volts
Plate Current .....	7	7.2	mA

**MAXIMUM CIRCUIT VALUES:**

Grid-Circuit Resistance:*	
For fixed-bias operation .....	0.5 max megohm
For cathode-bias operation .....	2.2 max megohms

\* A plate supply voltage of 300 volts may be used provided that a sufficiently large resistor is used in the plate circuit to limit the plate dissipation to 1.5 watts under any condition of operation.

• For operation at metal-shell temperatures up to 135° C.

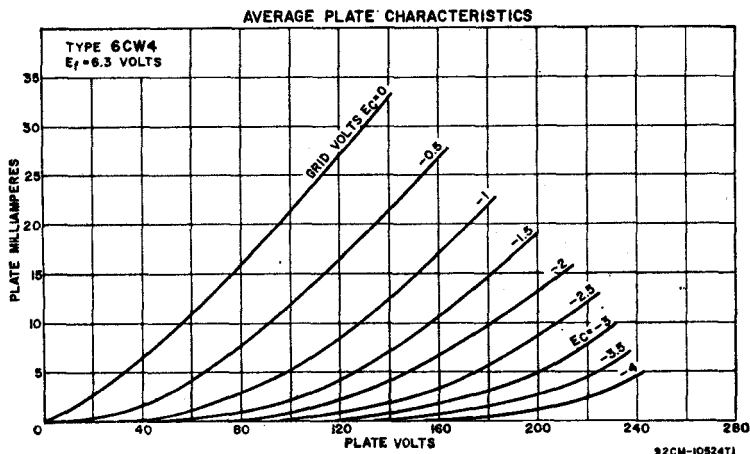

## POWER PENTODE

**6CW5**

Related types:  
8CW5, 10CW5,  
15CW5, 15CW5/PL84

Miniature types with frame-grid used for vertical-deflection amplifier service in television receivers. Outline 6G, Outlines section. Tubes require miniature nine-contact socket and may be mounted in any position. Types 8CW5,

10CW5, 15CW5, and 15CW5/PL84 are identical with type 6CW5 except for the heater ratings, as shown below.

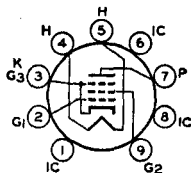

9CV

	6CW5	8CW5	10CW5	15CW5 15CW5/PL84	
Heater Voltage (ac/dc) .....	6.3	8	10.6	15	volts
Heater Current .....	0.6	0.6	0.45	0.3	ampere
Heater Warm-up Time .....	—	—	11	—	seconds
Peak Heater-Cathode Voltage:					
Heater negative with respect to cathode .....	330*max	330*max	330*max	330*max	volts
Heater positive with respect to cathode .....	330*max	330*max	330*max	330*max	volts
Direct Interelectrode Capacitances:					
Grid No.1 to Plate .....				0.6 max	pF
Grid No.1 to Heater .....				0.25 max	pF
Grid No.1 to Cathode, Heater, Grid No.2, and Grid No.3 .....				13	pF
Plate to Cathode, Heater, Grid No.2, and Grid No.3 .....				6.8	pF

\* The dc component must not exceed 220 volts.

## Class A, or Class AB, Amplifier

## MAXIMUM RATINGS (Design-Maximum Values):

Plate Voltage .....	275 max	volts
Plate Supply Voltage .....	600 max	volts
Grid-No.2 Voltage .....	220 max	volts
Grid-No.2 (Screen-Grid) Supply Voltage .....	600 max	volts
Plate Dissipation .....	14 max	watts
Grid-No.2 Input .....	2.1 max	watts
Peak Grid-No.2 Input .....	7 max	watts
Cathode Current .....	110 max	mA

## CHARACTERISTICS:

Plate Voltage .....	170	volts
Grid-No.2 Voltage .....	170	volts
Grid-No.1 (Control-Grid) Voltage .....	-12.5	volts
Amplification Factor .....	8	
Plate Resistance .....	26000	ohms
Transconductance .....	11000	μmhos
Plate Current .....	70	mA
Grid-No.2 Current .....	3.5	mA

## MAXIMUM CIRCUIT VALUES:

Grid-No.1-Circuit Resistance .....	1 max	megohm
------------------------------------	-------	--------

## Vertical Deflection Amplifier

For Operation in a 525-line, 30-frame system

## MAXIMUM RATINGS (Design-Maximum Values):

Plate Voltage .....	275 max	volts
Peak Positive-Pulse Plate Voltage# .....	2200 max	volts
Grid-No.2 Voltage .....	275 max	volts
Peak Negative-Pulse Grid-No.1 Voltage .....	-250 max	volts
Peak Cathode Current .....	240 max	mA
Average Cathode Current .....	110 max	mA
Plate Dissipation .....	12 max	watts
Grid-No.2 Input .....	2.1 max	watts

## MAXIMUM CIRCUIT VALUES:

Grid-No.1-Circuit Resistance .....	2.2 max	megohms
------------------------------------	---------	---------

# The duration of the voltage pulse must not exceed 6 per cent of one vertical scanning cycle. In a 525-line, 30-frame system, 6 per cent of one vertical scanning cycle is 1.2 milliseconds.



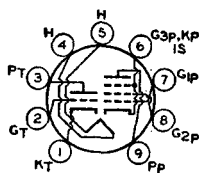

9DX

### MEDIUM-MU TRIODE— SHARP-CUTOFF PENTODE

Miniature type used in television receiver applications. Pentode unit is used as video amplifier; triode unit is used in sound intermediate-frequency amplifier, sweep-oscillator, sync-separator, sync-amplifier, and sync-clip-

## 6CX8

Related type:  
8CX8

per circuits. Outline 6E, **Outlines** section. Tube requires miniature nine-contact socket and may be mounted in any position. Type 8CX8 is identical with type 6CX8 except for the heater ratings, as shown below.

	6CX8	8CX8	
Heater Voltage (ac/dc)	6.3	8	volts
Heater Current	0.75	0.6	ampere
Heater Warm-up Time (Average)	—	11	volts
Peak Heater-Cathode Voltage:			
Heater negative with respect to cathode	200 max	200 max	volts
Heater positive with respect to cathode	200*max	200*max	volts

\* The dc component must not exceed 100 volts.

### Class A<sub>1</sub> Amplifier

#### MAXIMUM RATINGS (Design-Maximum Values):

	Triode Unit	Pentode Unit	
Plate Voltage	330 max	330 max	volts
Grid-No.2 (Screen-Grid) Supply Voltage	—	330 max	volts
Grid-No.2 Voltage	—	See curve page 80	
Grid-No.1 (Control-Grid) Voltage, Positive-bias value	0 max	0 max	volts
Plate Dissipation	2 max	5 max	watts
Grid-No.2 Input:			
For grid-No.2 voltages up to 165 volts	—	1.1 max	watts
For grid-No.2 voltages between 165 and 330 volts		See curve page 80	

#### CHARACTERISTICS:

Plate Supply Voltage	150	200	volts
Grid-No.2 Supply Voltage	—	125	volts
Cathode-Bias Resistor	150	68	ohms
Amplification Factor	40	—	
Plate Resistance (Approx.)	8700	70000	ohms
Transconductance	4600	10000	μmhos
Grid-No.1 (Voltage Approx.) for plate current of 100 μA	—5	—8.5	volts
Plate Current	9.2	24	mA
Grid-No.2 Current	—	52	mA

#### MAXIMUM CIRCUIT VALUES:

Grid-No.1-Circuit Resistance:			
For fixed-bias operation	0.5 max	0.25 max	megohm
For cathode-bias operation	1 max	1 max	megohm

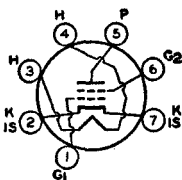

7EW

### SHARP-CUTOFF TETRODE

Miniature type used as rf amplifier in vhf tuners of television receivers. Outline 5C, **Outlines** section. Tube requires miniature seven-contact socket and may be mounted in any position.

## 6CY5

Related types:  
2CY5, 3CY5, 4CY5

Types 2CY5, 3CY5, and 4CY5 are identical with type 6CY5 except for the heater ratings, as shown below.

	2CY5	3CY5	4CY5	6CY5	
Heater Voltage (ac/dc)	2.4	2.9	4.5	6.3	volts
Heater Current	0.6	0.45	0.3	0.2	ampere
Heater Warm-up Time (Average)	11	11	11	—	seconds

**Peak Heater-Cathode Voltage:**

Heater negative with respect to cathode .....	100 max	volts
Heater positive with respect to cathode .....	100 max	volts
<b>Direct Interelectrode Capacitances (Approx.):*</b>		
Grid-No.1 to Plate .....	0.03	pF
Grid-No.1 to Cathode, Heater, Grid No.2, and Internal Shield .....	4.5	pF
Plate to Cathode, Heater, Grid No.2, and Internal Shield .....	3	pF

\* With external shield connected to cathode.

**Class A<sub>1</sub> Amplifier**

**MAXIMUM RATINGS (Design-Maximum Values):**

Plate Voltage .....	180 max	volts
Grid-No.2 (Screen-Grid) Supply Voltage .....	180 max	volts
Grid-No.2 Voltage .....	See curve page 80	
Grid-No.1 (Control-Grid) Voltage, Positive-bias value .....	0 max	volts
Cathode Current .....	20 max	mA
Grid-No.2 Input:		
For grid-No.2 voltages up to 90 volts .....	0.5 max	watt
For grid-No.2 voltages between 90 and 180 volts .....	See curve page 80	
Plate Dissipation .....	2 max	watts

**CHARACTERISTICS:**

Plate Voltage .....	125	volts
Grid-No.2 Voltage .....	80	volts
Grid-No.1 Voltage .....	-1	volt
Plate Resistance (Approx.) .....	0.1	megohm
Transconductance .....	8000	$\mu$ mhos
Plate Current .....	10	mA
Grid-No.2 Current .....	1.5	mA
Grid-No.1 Voltage (Approx.) for plate current of 20 $\mu$ A .....	-6	volts

**MAXIMUM CIRCUIT VALUES:**

Grid-No.1-Circuit Resistance .....	0.5 max	megohm
------------------------------------	---------	--------

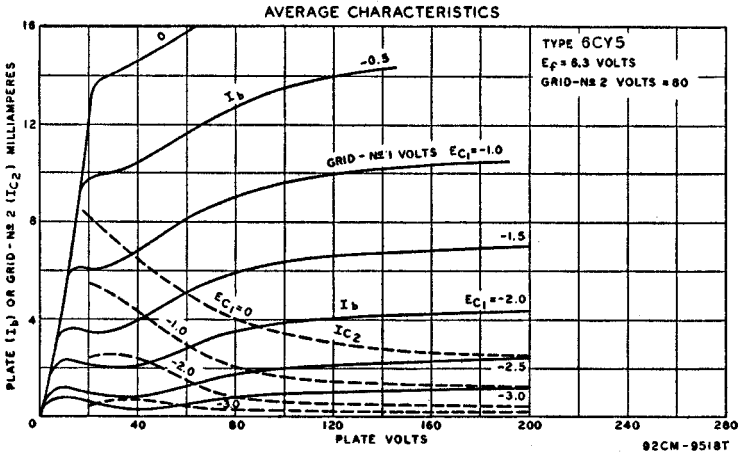

**DUAL TRIODE**

Miniature type used as combined vertical oscillator and vertical deflection amplifier in television receivers. Unit No.1 is a high- $\mu$  triode unit used as a blocking oscillator in vertical deflection circuits, and unit No.2 is a

**6CY7**

Related type:  
11CY7

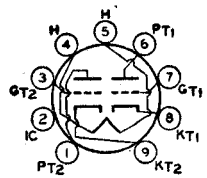

9LG

low-mu triode unit used as a vertical deflection amplifier. Outline 6E, **Outlines** section. Tube requires miniature nine-contact socket and may be mounted in any position. Type 11CY7 is identical with type 6CY7 except for the heater ratings, as shown below.

	6CY7	11CY7	
Heater Voltage (ac/dc) .....	6.3	11	volts
Heater Current .....	0.75	0.45	ampere
Heater Warm-up Time (Average) .....	—	11	seconds
Peak Heater-Cathode Voltage:			
Heater negative with respect to cathode .....	200 max	200 max	volts
Heater positive with respect to cathode .....	200*max	200*max	volts

\* The dc component must not exceed 100 volts.

### Class A<sub>1</sub> Amplifier

<b>CHARACTERISTICS:</b>	Unit No.1	Unit No.2	
Plate Supply Voltage .....	250	150	volts
Grid Voltage .....	-3	—	volts
Cathode-Bias Resistor .....	—	620	ohms
Amplification Factor .....	68	5	
Plate Resistance (Approx.) .....	52000	920	ohms
Transconductance .....	1300	5400	μmhos
Grid Voltage (Approx.) for plate current of 10 μA ..	-5.5	—	volts
Grid Voltage (Approx.) for plate current of 200 μA ..	—	-40	volts
Plate Current .....	1.2	30	mA
Plate Current for grid voltage of -30 volts .....		3.5	mA

### Vertical Deflection Oscillator and Amplifier

For operation in a 525-line, 30-frame system

<b>MAXIMUM RATINGS (Design-Maximum Values):</b>	Unit No.1	Unit No.2	
DC Plate Voltage .....	Oscillator	Amplifier	
Peak Positive-Pulse Plate Voltage# .....	350 max	350 max	volts
Peak Negative-Pulse Grid Voltage .....	—	1800 max	volts
Peak Cathode Current .....	-400 max	-250 max	volts
Average Cathode Current .....	—	120 max	mA
Plate Dissipation .....	—	35 max	mA
	1 max	5.5 max	watts

**MAXIMUM CIRCUIT VALUES:**

Grid-Circuit Resistance .....	2.2 max	2.2†max megohms
-------------------------------	---------	-----------------

# The duration of the voltage pulse must not exceed 15 per cent of one vertical scanning cycle. In a 525-line, 30-frame system, 15 per cent of one vertical scanning cycle is 2.5 milliseconds.

† For cathode-bias operation.

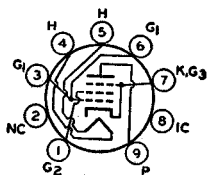

**9HN**

18 kilovolts. Also used in the audio output stage of television and radio receivers. This type has a controlled heater warm-up time for use in receivers employing series-connected heater strings. Outline 6G, **Outlines** section. Tube requires miniature nine-contact socket and may be mounted in any position. Type 5CZ5 is identical with type 6CZ5 except for the heater ratings, as shown below.

### BEAM POWER TUBE

Miniature type used as a vertical deflection amplifier in high-efficiency deflection circuits of television receivers utilizing picture tubes having diagonal deflection angles of 110 degrees and operating at ultor voltages up to

## 6CZ5

Related type:  
5CZ5

	5CZ5	6CZ5	
Heater Voltage (ac/dc) .....	4.7	6.3	volts
Heater Current .....	0.6	0.45	ampere
Heater Warm-up Time (Average) .....	11	11	seconds
Peak Heater-Cathode Voltage:			
Heater negative with respect to cathode .....	200 max	200 max	volts
Heater positive with respect to cathode .....	200 <sup>a</sup> max	200 <sup>a</sup> max	volts
Direct Interelectrode Capacitances:			
Grid No.1 to Plate .....		0.4 max	pF
Grid No.1 to Cathode, Heater, Grid No.2, and Grid No.3 .....		9	pF
Plate to Cathode, Heater, Grid No.2, and Grid No.3 .....		6	pF
Plate Resistance (Approx.)* .....		0.073	megohm
Transconductance* .....		4800	$\mu$ mhos

\* Plate and grid-No.2 volts, 250; grid-No.1 volts, -14; plate mA, 46; grid-No.2 mA, 4.6.

### Vertical Deflection Amplifier

For operation in a 525-line, 30-frame system

#### MAXIMUM RATINGS (Design-Maximum Values):

DC Plate Voltage .....	350 max	volts
Peak Positive-Pulse Plate Voltage# .....	2200 max	volts
Grid-No.2 (Screen-Grid) Voltage .....	315 max	volts
Peak Negative-Pulse Grid-No.1 (Control-Grid) Voltage .....	-275 max	volts
Peak Cathode Current .....	155 max	mA
Average Cathode Current .....	45 max	mA
Plate Dissipation .....	10 max	watts
Grid-No.2 Input .....	2.2 max	watts
Bulb Temperature (At hottest point) .....	250 max	$^{\circ}$ C

#### MAXIMUM CIRCUIT VALUES:

Grid-No.1-Circuit Resistance:		
For fixed-bias operation .....	0.5 max	megohm
For cathode-bias operation .....	1.0 max	megohm

# The duration of the voltage pulse must not exceed 15 per cent of one vertical scanning cycle. In a 525-line, 30-frame system, 15 per cent of one vertical scanning cycle is 2.5 milliseconds.

\* The dc component must not exceed 100 volts.

### HIGH-MU TRIPLE TRIODE

# 6D10

Duodecar type used in oscillator-mixer, grounded-grid amplifier, and automatic-frequency-control circuits. Outline 8A, Outlines section. Type requires duodecar twelve-contact socket and may be mounted in any position.

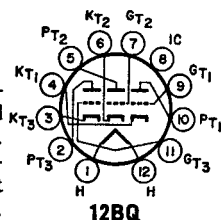

12BQ

Heater volts (ac/dc), 6.3; amperes, 0.45; peak heater-cathode volts, 200 (the dc component must not exceed 100 volts when the heater is positive with respect to the cathode).

### Class A<sub>1</sub> Amplifier

#### MAXIMUM RATINGS (Design-Maximum Values, Each Triode Unit):

Plate Voltage .....	330 max	volts
Grid Voltage:		
Positive-bias value .....	0 max	volts
Negative-bias value .....	-50 max	volts
Plate Dissipation .....	2 max	watts
Total Plate Dissipation (All plates) .....	6 max	watts

#### CHARACTERISTICS (Each Triode Unit):

Plate Voltage .....	125	volts
Grid Voltage .....	-1	volts
Amplification Factor .....	57	
Plate Resistance (Approx.) .....	13600	ohms
Transconductance .....	4200	$\mu$ mhos
Plate Current .....	4.2	mA
Grid Voltage (Approx.) for plate current of 20 $\mu$ A .....	-4	volts

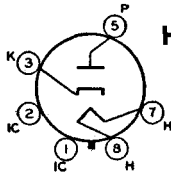

4CG

### HALF-WAVE VACUUM RECTIFIER

Glass octal type used as damper tube in horizontal-deflection circuits of television receivers. Outline 13D, **Outlines** section. Tube requires octal socket and may be mounted in any position. May be supplied with pin

## 6DA4

Related type:  
17D4

No.1 omitted. Socket terminals 1, 2, 4, and 6 should not be used as tie points. It is important that this tube, like other power-handling tubes, be adequately ventilated. Type 17D4 is identical with type 6DA4 except for the heater ratings, as shown below.

Heater Voltage (ac/dc) .....	6DA4 6.3	17D4 16.8	volts
Heater Current .....	1.2	0.45	ampere
Heater Warm-up Time (Average) .....	—	11	seconds

#### Damper Service

For operation in a 525-line, 30-frame system

#### MAXIMUM RATINGS (Design-Maximum Values):

Peak Inverse Plate Current*	4400 max	volts
Peak Plate Current .....	900 max	mA
DC Plate Current .....	155 max	mA
Plate Dissipation .....	5.5 max	watts

#### Peak Heater-Cathode Voltage:

Heater negative with respect to cathode .....	4400*max	volts
Heater positive with respect to cathode .....	300*max	volts

\* The duration of the voltage pulse must not exceed 15 per cent of one horizontal scanning cycle. In a 525-line, 30-frame system, 15 per cent of one horizontal scanning cycle is 10 microseconds.

- The dc component must not exceed 900 volts.
- The dc component must not exceed 100 volts.

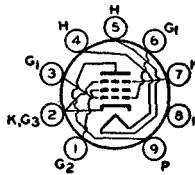

9GR

### BEAM POWER TUBE

Miniature type used as vertical-deflection-amplifier tube in television receivers. Outline 6F, **Outlines** section. Tube requires miniature nine-contact socket and may be operated in any position. Type 12DB5 is identical

## 6DB5

Related type:  
12DB5

with type 6DB5 except for the heater ratings, as shown below.

Heater Voltage (ac/dc) .....	6DB5 6.3	12DB5 12.6	volts
Heater Current .....	1.2	0.6	ampere
Heater Warm-up Time (Average) .....	—	11	seconds

Peak Heater-Cathode Voltage:

Heater negative with respect to cathode .....	200 max	200 max	volts
Heater positive with respect to cathode .....	200*max	200*max	volts

- The dc component must not exceed 100 volts.

#### Class A<sub>1</sub> Amplifier

#### MAXIMUM RATINGS (Design-Center Values):

Plate Voltage .....	300 max	volts
Grid-No.2 (Screen-Grid) Voltage .....	150 max	volts
Grid-No.2 Input .....	1.25 max	watts
Plate Dissipation .....	10 max	watts

#### TYPICAL OPERATION:

Plate Supply Voltage .....	200	volts
Grid-No.2 Supply Voltage .....	125	volts
Cathode-Bias Resistor .....	180	ohms
Peak AF Grid-No.1 Voltage .....	8.5	volts
Zero-Signal Plate Current .....	46	mA
Maximum-Signal Plate Current .....	47	mA
Zero-Signal Grid-No.2 Current .....	2.2	mA
Maximum-Signal Grid-No.2 Current .....	8.5	mA

Plate Resistance (Approx.) .....	28000	ohms
Transconductance .....	8000	$\mu$ mhos
Load Resistance .....	4000	ohms
Total Harmonic Distortion .....	10	per cent
Maximum-Signal Power Output .....	3.8	watts

**MAXIMUM CIRCUIT VALUES:**

Grid-No.1 Circuit Resistance:		
For fixed-bias operation .....	0.1 max	megohm
For cathode-bias operation .....	2.2 max	megohms

**Vertical-Deflection Amplifier**

For operation in a 525-line, 30-frame system

**MAXIMUM RATINGS (Design-Center Values):**

DC Plate Voltage .....	300 max	volts
Peak Positive-Pulse Plate Voltage (Absolute Maximum) <sup>▲</sup> .....	2000*max	volts
DC Grid-No.2 (Screen-Grid) Voltage .....	150 max	volts
Peak Negative-Pulse Grid-No.1 (Control-Grid) Voltage .....	-250 max	volts
Peak Cathode Current .....	200 max	mA
Average Cathode Current .....	55 max	mA
Grid-No.2 Input .....	1.25 max	watts
Plate Dissipation .....	10 max	watts

**MAXIMUM CIRCUIT VALUES:**

Grid-No.1-Circuit Resistance:		
For fixed-bias operation .....	0.1 max	megohm
For cathode-bias operation .....	2.2 max	megohms

<sup>▲</sup> The duration of the voltage pulse must not exceed 15 per cent of one vertical scanning cycle. In a 525-line, 30-frame system, 15 per cent of one vertical scanning cycle is 2.5 milliseconds.

\* Under no circumstances should this absolute maximum value be exceeded.

**SHARP-CUTOFF PENTODE**

Miniature type used in the gain-controlled picture if stages of color television receivers. It is also used as a radio-frequency amplifier in the tuners of such receivers. Outline 5C, Outlines section. Tube requires seven-

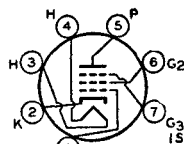
**7CM****6DC6**

contact miniature socket and may be mounted in any position.

Heater Voltage (ac/dc) .....	6.3	volts
Heater Current .....	0.3	ampere
Peak Heater-Cathode Voltage:		
Heater negative with respect to cathode .....	200 max	volts
Heater positive with respect to cathode .....	200*max	volts

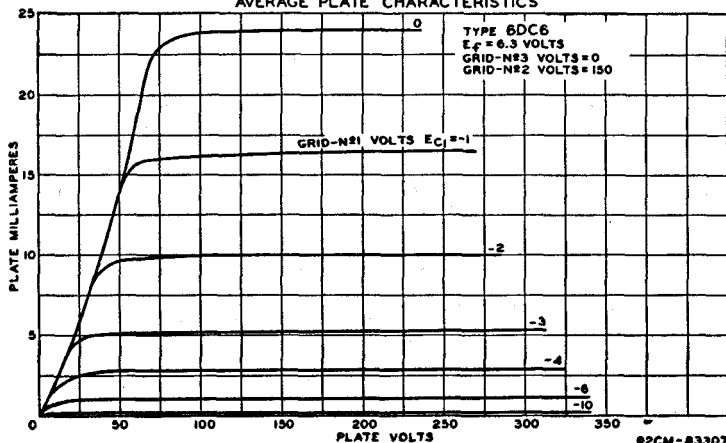
**AVERAGE PLATE CHARACTERISTICS**

©2CM-833071

Direct Interelectrode Capacitances:

Grid No.1 to Plate .....	0.02 max	pF
Grid No.1 to Cathode, Heater, Grid No.2, Grid No.3, and Internal Shield .....	6.5	pF
Plate to Cathode, Heater, Grid No.2, Grid No.3, and Internal Shield .....	2	pF

• The dc component must not exceed 100 volts.

**Class A<sub>1</sub> Amplifier**

**MAXIMUM RATINGS (Design-Center Values):**

Plate Voltage .....	300 max	volts
Grid-No.3 (Suppressor-Grid) Voltage, Positive value .....	0 max	volts
Grid-No.2 Supply Voltage .....	300 max	volts
Grid-No.2 (Screen-Grid) Voltage .....	See curve	page 80
Grid-No.1 (Control-Grid) Voltage, Positive-bias value .....	0 max	volts
Plate Dissipation .....	2 max	watts
Grid-No.2 Input:		
For grid-No.2 voltages up to 150 volts .....	0.5 max	watt
For grid-No.2 voltages between 150 and 300 volts .....	See curve	page 80

**CHARACTERISTICS:**

Plate Supply Voltage .....	200	volts
Grid No.3 .....	Connected to cathode at socket	
Grid-No.2 Supply Voltage .....	150	volts
Cathode-Bias Resistor .....	180	ohms
Plate Resistance (Approx.) .....	0.5	megohm
Transconductance .....	5500	μmhos
Grid-No.1 Voltage (Approx.) for transconductance of 50 μmhos .....	-12.5	volts
Plate Current .....	9	mA
Grid-No.2 Current .....	3	mA

**MAXIMUM CIRCUIT VALUES:**

Grid-No.1-Circuit Resistance:		
For fixed-bias operation .....	0.25 max	megohm
For cathode-bias operation .....	1.0 max	megohm

**TWIN DIODE—  
SEMIREMOTE-CUTOFF PENTODE**

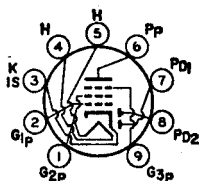

Miniature types used as rf- and if-amplifier tubes in radio and television receivers. Outline 6E, Outlines section. Tubes require nine-contact socket and may be mounted in any position.

**6DC8/  
EBF89**

Heater Voltage (ac/dc) .....	6.3	volts
Heater Current .....	0.3	ampere
Peak Heater-Cathode Voltage:		
Heater negative with respect to cathode .....	100 max	volts
Heater positive with respect to cathode .....	100 max	volts

Direct Interelectrode Capacitances:

Pentode Unit:

Grid No.1 to Plate .....	0.0025 max	pF
Grid No.1 to All Other Electrodes Except Plate .....	5	pF
Plate to All Other Electrodes Except Grid No.1 .....	5.2	pF
Grid No.1 to Heater .....	0.05 max	pF
Plate of Each Diode Unit to All Other Electrodes .....	2.5	pF
Plate of Diode Unit No.1 to Plate of Diode Unit No.2 .....	0.25 max	pF
Plate of Diode Unit No.1 to Heater .....	0.015 max	pF
Plate of Diode Unit No.2 to Heater .....	0.003 max	pF
Plate of Diode Unit No.1 to Pentode Grid No.1 .....	0.0008 max	pF
Plate of Diode Unit No.2 to Pentode Grid No.1 .....	0.001 max	pF
Plate of Diode Unit No.1 to Pentode Plate .....	0.15 max	pF
Plate of Diode Unit No.2 to Pentode Plate .....	0.025 max	pF

**Pentode Unit as Class A<sub>1</sub> Amplifier**

**MAXIMUM RATINGS (Design-Center Values):**

Plate Supply Voltage .....	550 max	volts
Plate Voltage .....	300 max	volts
Grid-No.2 Voltage:		
With plate current greater than 8 mA .....	125 max	volts
With plate current less than 4 mA .....	300 max	volts

Cathode Current .....	16.5 max	mA
Grid-No.2 Input .....	0.45 max	watts
Plate Dissipation .....	2.25 max	watts

**CHARACTERISTICS:**

Plate Voltage .....	200	250	volts
Grid No.3 .....	Connected to cathode at socket		
Grid-No.2 Voltage .....	100	100	volts
Grid-No.1 Voltage .....	-1.5	-2	volts
Mu Factor, Grid No.2 to Grid No.1 .....	20	20	
Plate Resistance (Approx.) .....	0.6	1	megohm
Transconductance .....	4500	3800	$\mu$ mhos
Plate Current .....	11	9	mA
Grid-No.2 Current .....	3.3	2.7	mA
Transconductance, at grid-No.1 voltage of -20 volts ..	120	200	$\mu$ mhos

**MAXIMUM CIRCUIT VALUES:**

Grid-No.1-Circuit Resistance .....	3 max	megohms
------------------------------------	-------	---------

**Diode Units (Each Unit)****MAXIMUM RATINGS (Design-Center Values):**

Peak Inverse Plate Voltage .....	200 max	volts
Peak Plate Current .....	5 max	mA
Average Plate Current .....	0.8 max	mA

**HALF-WAVE VACUUM RECTIFIER****6DE4**

Related types:  
17DE4, 22DE4

Glass octal type used as damper tube in horizontal-deflection circuits of television receivers. Outline 13G, Outlines section. Tube requires octal socket and may be operated in any position. Socket terminals 1, 2, 4, and 6 should not be used as tie points. It is important that this tube, like other power-handling tubes, be adequately ventilated. Types 17DE4 and 22DE4 are identical with type 6DE4 except for the heater ratings, as shown below.

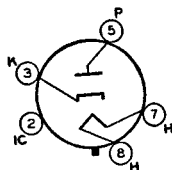
**4CG**

	6DE4	17DE4	22DE4	
Heater Voltage (ac/dc) .....	6.3	17	22.4	volts
Heater Current .....	1.6	0.6	0.45	ampere
Heater Warm-up Time (Average) .....	—	11	11	seconds
Direct Interelectrode Capacitances (Approx.):				
Plate to Cathode and Heater .....			8.5	pF
Cathode to Plate and Heater .....			11.5	pF
Heater to Cathode .....			4	pF

**Damper Service**

For operation in a 525-line, 30-frame system

**MAXIMUM RATINGS (Design-Maximum Values):**

Peak Inverse Plate Voltage# .....	5500 max	volts
Peak Plate Current .....	1100 max	mA
DC Plate Current .....	180 max	mA
Plate Dissipation .....	6.5 max	watts

**Peak Heater-Cathode Voltage:**

Heater negative with respect to cathode .....	5500*max	volts
Heater positive with respect to cathode .....	300*max	volts

**CHARACTERISTICS, Instantaneous Value:**

Tube Voltage Drop for plate current of 350 mA .....	34	volts
---	----	-------

# The duration of the voltage pulse must not exceed 15 per cent of one horizontal scanning cycle. In a 525-line, 30-frame system, 15 per cent of one horizontal scanning cycle is 10 microseconds.

- \* The dc component must not exceed 900 volts.
- The dc component must not exceed 100 volts.



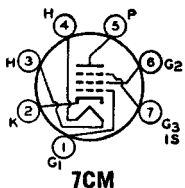

### SHARP-CUTOFF PENTODE

Miniature type used in the gain-controlled picture if stages of television receivers utilizing an intermediate frequency in the order of 40 megacycles per second. Also used as an rf amplifier in vhf television tuners. This

## 6DE6

Related type:  
4DE6

tube features very high transconductance combined with low interelectrode capacitance values, and is provided with separate base pins for grid No.3 and cathode to permit the use of an unbypassed cathode resistor to minimize the effects of regeneration. Outline 5C, Outlines section. Tube requires miniature seven-contact socket and may be mounted in any position. Type 4DE6 is identical with type 6DE6 except for the heater ratings, as shown below.

Heater Voltage (ac/dc)	4DE6 4.2	6DE6 6.3	volts
Heater Current	0.45	0.3	ampere
Heater Warm-up Time (Average)	11	—	seconds
Peak Heater-Cathode Voltage:			
Heater negative with respect to cathode	200 max	200 max	volts
Heater positive with respect to cathode	200*max	200*max	volts
Direct Interelectrode Capacitances:			
Grid No.1 to Plate	0.025 max	0.015 max	pF
Grid No.1 to Cathode, Heater, Grid No.2, Grid No.3, and Internal Shield	6.5	6.5	pF
Plate to Cathode, Heater, Grid No.2, Grid No.3, and Internal Shield	2	3	pF

\* The dc component must not exceed 100 volts.

▲ With external shield connected to cathode.

### Class A<sub>1</sub> Amplifier

#### MAXIMUM RATINGS (Design-Maximum Values):

Plate Voltage	330 max	volts
Grid-No.3 (Suppressor-Grid) Voltage, Positive value	0 max	volts
Grid-No.2 (Screen-Grid) Supply Voltage	330 max	volts
Grid-No.2 Voltage	See curve	page 80
Grid-No.1 (Control-Grid) Voltage, Positive-bias value	0 max	volts
Plate Dissipation	2.3 max	watts
Grid-No.2 Input:		
For grid-No.2 voltages up to 165 volts	0.55 max	watt
For grid-No.2 voltages between 165 and 330 volts	See curve	page 80

#### AVERAGE PLATE CHARACTERISTICS

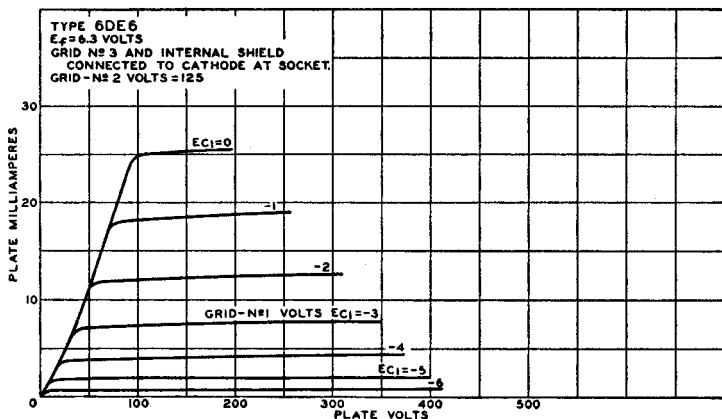

**CHARACTERISTICS:**

Plate Supply Voltage .....	125	volts
Grid No.3 .....	Connected to cathode at socket	volts
Grid-No.2 Supply Voltage .....	125	volts
Cathode-Bias Resistor .....	56	ohms
Plate Resistance (Approx.) .....	0.25	megohm
Transconductance .....	8000	$\mu$ mhos
Transconductance for grid-No.1 volts of $-5.5$ and cathode resistor of 0 ohms .....	700	$\mu$ mhos
Grid-No.1 Voltage (Approx.) for plate current of 20 $\mu$ A .....	$-9$	volts
Plate Current .....	15.5	mA
Grid-No.2 Current .....	4.2	mA

**DUAL TRIODE****6DE7**

Related types:  
10DE7, 13DE7

Miniature type used as combined vertical oscillator and vertical-deflection amplifier in television receivers. Unit No.1 is a medium-mu triode unit used as a blocking oscillator in vertical-deflection circuits, and unit No.2 is a

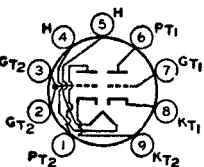
**9HF**

low-mu triode unit used as a vertical-deflection amplifier. Outline 6E, **Outlines** section. Tube requires miniature nine-contact socket and may be mounted in any position. For curve of average plate characteristics, Unit No.2, refer to type 6DR7. Types 10DE7 and 13DE7 are identical with type 6DE7 except for the heater ratings, as shown below.

	6DE7	10DE7	13DE7	
Heater Voltage (ac/dc) .....	6.3	9.7	13	volts
Heater Current .....	0.9	0.6	0.45	ampere
Heater Warm-up Time (Average) .....	—	11	11	seconds
Peak Heater-Cathode Voltage:				
Heater negative with respect to cathode ..	200 max	200 max	200 max	volts
Heater positive with respect to cathode ..	200*max	200*max	200*max	volts
Direct Interelectrode Capacitances (Approx.):		Unit No.1	Unit No.2	
Grid to Plate .....		4	8.5	pF
Grid to Cathode and Heater .....		2.2	5.5	pF
Plate to Cathode and Heater .....		0.52	1	pF

\* The dc component must not exceed 100 volts.

**Class A<sub>1</sub> Amplifier****CHARACTERISTICS:**

	Unit No.1	Unit No.2	
Plate Voltage .....	250	150	volts
Grid Voltage .....	$-11$	$-17.5$	volts
Amplification Factor .....	17.5	6	
Plate Resistance (Approx.) .....	8750	925	ohms
Transconductance .....	2000	6500	$\mu$ mhos
Plate Current .....	5.5	35	mA
Plate Current for grid voltage of $-24$ volts .....	—	10	mA
Grid Voltage (Approx.) for plate current of 10 $\mu$ A ..	$-20$	—	volts
Grid Voltage (Approx.) for plate current of 50 $\mu$ A ..	—	$-44$	volts

**Vertical-Deflection Oscillator and Amplifier**

For operation in a 525-line, 30-frame system

	Unit No.1 Oscillator	Unit No.2 Amplifier	
<b>MAXIMUM RATINGS</b> (Design-Maximum Values):			
DC Plate Voltage .....	330 max	275 max	volts
Peak Positive-Pulse Plate Voltage# .....	—	1500 max	volts
Peak Negative-Pulse Grid Voltage .....	$-400$ max	$-250$ max	volts
Peak Cathode Current .....	77 max	175 max	mA
Average Cathode Current .....	22 max	50 max	mA
Plate Dissipation .....	1.5 max	7 max	watts

**MAXIMUM CIRCUIT VALUES:**

Grid-Circuit Resistance:

For grid-resistor bias or cathode-bias operation .....

2.2 max

2.2 max megohms

# The duration of the voltage pulse must not exceed 15 per cent of one vertical scanning cycle.

In a 525-line, 30-frame system, 15 per cent of one vertical scanning cycle is 2.5 milliseconds.

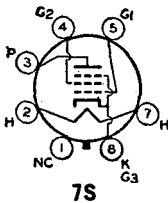
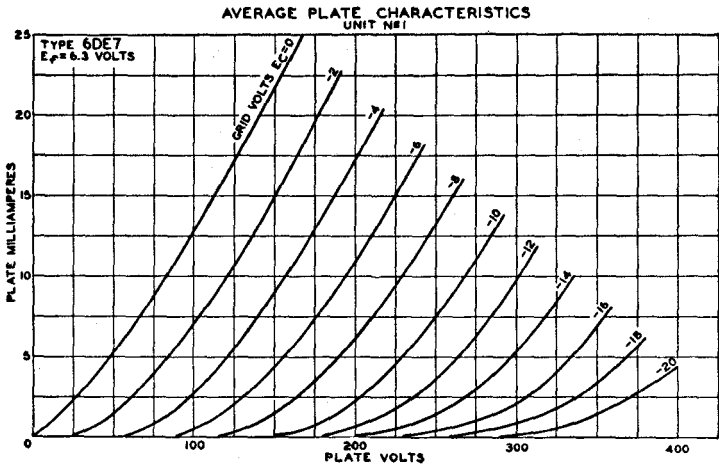

**BEAM POWER TUBE**

Glass octal type used as output tube in audio-amplifier applications. Outline 13D, **Outlines** section. Tube requires octal socket and may be mounted in any position. This type may be supplied with pin 1 omitted.

**6DG6GT**

Heater Voltage (ac/dc) .....	6.3	volts
Heater Current .....	1.2	amperes
Peak Heater-Cathode Voltage:		
Heater negative with respect to cathode .....	200 max	volts
Heater positive with respect to cathode .....	200*max	volts
Direct Interelectrode Capacitances (Approx.):		
Grid No.1 to Plate .....	0.6	pF
Grid No.1 to Cathode, Heater, Grid No.2 and Grid No.3 .....	15	pF
Plate to Cathode, Heater, Grid No.2, and Grid No.3 .....	10	pF

\* The dc component must not exceed 100 volts.

**Class A<sub>1</sub> Audio-Frequency Power Amplifier**

<b>MAXIMUM RATINGS</b> (Design-Center Values):		
Plate Voltage .....	200 max	volts
Grid-No.2 (Screen-Grid) Voltage .....	125 max	volts
Plate Dissipation .....	10 max	watts
Grid-No.2 Input .....	1.25 max	watts
<b>TYPICAL OPERATION:</b>		
Plate Supply Voltage .....	110	200
Grid-No.2 Supply Voltage .....	110	125
Grid-No.1 (Control-Grid) Supply Voltage .....	-7.5	—
Peak AF Grid-No.1 Voltage .....	7.5	8.5
Cathode-Bias Resistor .....	—	180
Zero-Signal Plate Current .....	49	46
Maximum-Signal Plate Current .....	50	47
Zero-Signal Grid-No.2 Current .....	4	2.2
Maximum-Signal Grid-No.2 Current .....	10	8.5
Plate Resistance (Approx.) .....	13000	28000
Transconductance .....	8000	8000
Load Resistance .....	2000	4000
Total Harmonic Distortion .....	10	10
Maximum-Signal Power Output .....	2.1	3.8

**MAXIMUM CIRCUIT VALUES:**

Grid-No.1-Circuit Resistance:

For fixed-bias operation .....	0.1 max megohm
For cathode-bias operation .....	0.5 max megohm

**SHARP-CUTOFF PENTODE****6DK6**

Related types:

3DK6, 4DK6, 12DK6

Miniature type used as intermediate-frequency amplifier tube in television receivers. This tube features high transconductance at low plate and grid-No.2 voltages, combined with low interelectrode capacitances. Out-

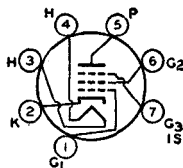
**7CM**

line 5C, **Outlines** section. Tube requires miniature seven-contact socket and may be mounted in any position. Types 3DK6, 4DK6, and 12DK6 are identical with type 6DK6 except for the heater ratings, as shown below.

	3DK6	4DK6	6DK6	12DK6	
Heater Voltage (ac/dc) .....	3.15	4.2	6.3	12.6	volts
Heater Current .....	0.6	0.45	0.3	0.15	ampere
Heater Warm-up Time (Average) .....	11	11	—	—	seconds
<b>Peak Heater-Cathode Voltage:</b>					
Heater negative with respect to cathode .....	300 max	200 max	200 max	200 max	volts
Heater positive with respect to cathode .....	200*max	200*max	200*max	200*max	volts
<b>Direct Interelectrode Capacitances:</b>					
Grid No.1 to Plate .....				0.025 max	pF
Grid No.1 to Cathode, Heater, Grid No.2, Grid No.3 and Internal Shield .....				6.3	pF
Plate to Cathode, Heater, Grid No.2, Grid No.3, and Internal Shield .....				1.9	pF

\* The dc component must not exceed 100 volts.

**Class A<sub>1</sub> Amplifier****MAXIMUM RATINGS** (Design-Maximum Values):

Plate Voltage .....	330 max	volts
Grid-No.3 (Suppressor-Grid) Voltage, Positive value .....	0 max	volts
Grid-No.2 (Screen-Grid) Supply Voltage .....	330 max	volts
Grid-No.2 Voltage .....	See curve	page 80
Grid-No.1 (Control-Grid) Voltage, Positive-bias value .....	0 max	volts
Plate Dissipation .....	2.3 max	watts

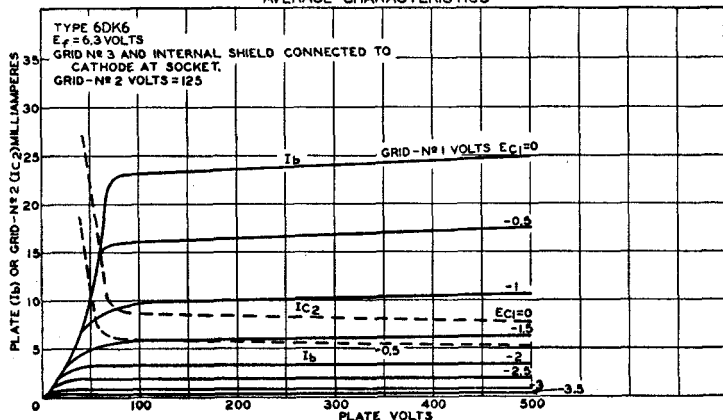
**AVERAGE CHARACTERISTICS**

**Grid-No.2 Input:**

For grid-No.2 voltages up to 165 volts .....	<b>0.55 max</b>	watt
For grid-No.2 voltages between 165 and 330 volts .....	See curve page 80	

**CHARACTERISTICS:**

Plate Supply Voltage .....	125	volts
Grid No.3 .....	Connected to cathode	at socket
Grid-No.2 Supply Voltage .....	125	volts
Cathode-Bias Resistor .....	56	ohms
Plate Resistance (Approx.) .....	0.35	megohm
Transconductance .....	9800	μmhos
Grid-No.1 Voltage (Approx.) for plate current of 20 μA .....	-6.5	volts
Plate Current .....	12	mA
Grid-No.2 Current .....	3.8	mA

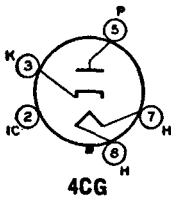

**HALF-WAVE VACUUM RECTIFIER**

Glass octal type used as damper tube in horizontal-deflection circuits of television receivers. Outline 13G, Outlines section. Tube requires octal socket and may be operated in any position. Socket terminals 1, 2, 4, and 6 should not be used as tie points. It is important that this tube, like other power-handling tubes, be adequately ventilated. Types 12DM4A and 17DM4A are identical with type 6DM4A except for the heater ratings, as shown below.

**6DM4A**

Related types:  
12DM4A, 17DM4A

	6DM4A	12DM4A	17DM4A	
Heater Voltage (ac/dc) .....	6.3	12.6	16.8	volts
Heater Current .....	1.2	0.6	0.45	ampere
Heater Warm-up Time (Average) .....	—	11	11	seconds
<b>Direct Interelectrode Capacitances (Approx.):</b>				
Plate to Cathode and Heater .....			8.5	pF
Cathode to Plate and Heater .....			11.5	pF
Heater to Cathode .....			4	pF

**Damper Service**

For operation in a 525-line, 30-frame system

**MAXIMUM RATINGS (Design-Maximum Values):**

Peak Inverse Plate Voltage* .....	5000 max	volts
Peak Plate Current .....	1200 max	mA
DC Plate Current .....	200 max	mA
Plate Dissipation .....	6.5 max	watts
<b>Peak Heater-Cathode Voltage:</b>		
Heater negative with respect to cathode .....	5000*max	volts
Heater positive with respect to cathode .....	300*max	volts

\* The duration of the voltage pulse must not exceed 15 per cent of one horizontal scanning cycle. In a 525-line, 30-frame system, 15 per cent of one horizontal scanning cycle is 10 microseconds.

- The dc component must not exceed 900 volts.
- The dc component must not exceed 100 volts.

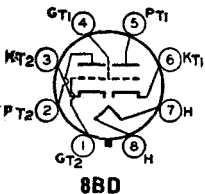

**MEDIUM-MU DUAL TRIODE**

Glass octal type used as combined vertical-deflection-oscillator and vertical-deflection-amplifier tube in television receivers. Outline 13B, Outlines section. Tube requires octal socket and may be mounted in any position.

**6DN7**

Heater volts (ac/dc), 6.3; amperes, 0.9; peak heater-cathode volts, 200 (the dc component must not exceed 100 volts when the heater is positive with respect to the cathode).

**Class A<sub>1</sub> Amplifier**

**CHARACTERISTICS:**

	Unit No.1	Unit No.2	
Plate Voltage .....	250	250	volts
Grid Voltage .....	-8	-9.5	volts
Amplification Factor .....	22.5	15.4	
Plate Resistance (Approx.) .....	9000	2000	ohms
Transconductance .....	2500	7700	μmhos
Plate Current .....	8	41	mA
Grid Voltage (Approx.) for plate current of 10 μA .....	-18	—	volts
Grid Voltage (Approx.) for plate current of 50 μA .....	—	-23	volts

**Vertical-Deflection Oscillator and Amplifier**

For operation in a 525-line, 30-frame system

	Unit No.1 Oscillator	Unit No.2 Amplifier	
<b>MAXIMUM RATINGS (Design-Maximum Values):</b>			
DC Plate Voltage .....	350 max	550 max	volts
Peak Positive-Pulse Plate Voltage# .....	—	2500 max	volts
Peak Negative-Pulse Grid Voltage .....	400 max	250 max	mA
Peak Cathode Current .....	—	150 max	mA
Average Cathode Current .....	—	50 max	mA
Plate Dissipation .....	1 max	10 max	watts

**MAXIMUM CIRCUIT VALUES:**

<b>Grid-Circuit Resistance:</b>		
For fixed-bias operation .....	2.2 max	2.2 max megohms
For cathode-bias operation .....	2.2 max	— megohms

# The duration of the voltage pulse must not exceed 15 per cent of one vertical scanning cycle. In a 525-line, 30-frame system, 15 per cent of one vertical cycle is 2.5 milliseconds.

**HALF-WAVE VACUUM RECTIFIER**

**6DQ4**

Glass octal type used as damper tube in horizontal-deflection circuits of television receivers. Outline 13F, **Outlines** section. Tube requires octal socket and may be mounted in any position. Socket terminals 1, 2, 4, and

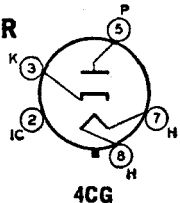

**4CG**

6 should not be used as tie points. Heater volts (ac/dc), 6.3; amperes, 1.2.

**Damper Service**

For operation in a 525-line, 30-frame system

<b>MAXIMUM RATINGS (Design-Maximum Values):</b>		
Peak Inverse Plate Voltage# .....	5500 max	volts
Peak Plate Current .....	1000 max	mA
DC Plate Current .....	175 max	mA
Plate Dissipation .....	6 max	watts
<b>Peak Heater-Cathode Voltage:</b>		
Heater negative with respect to cathode .....	5500 max	volts
Heater positive with respect to cathode .....	300 max	volts

**CHARACTERISTICS, Instantaneous Value:**

Tube Voltage Drop for plate current of 250 mA .....	32	volts
---	----	-------

# The duration of the voltage pulse must not exceed 15 per cent of one horizontal scanning cycle. In a 525-line, 30-frame system, 15 per cent of one horizontal scanning cycle is 10 microseconds.

- The dc component must not exceed 900 volts.
- The dc component must not exceed 100 volts.

**BEAM POWER TUBE**

**6DQ5**

Glass octal type used as horizontal deflection amplifier in color television receivers. Outline 21B, **Outlines** section. Tube requires octal socket and may be mounted in any position.

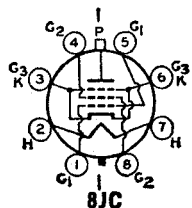

**8JC**

Heater Voltage (ac/dc) .....	6.3	volts
Heater Current .....	2.5	amperes
Peak Heater-Cathode Voltage:		
Heater negative with respect to cathode .....	200 max	volts
Heater positive with respect to cathode .....	200*max	volts
Direct Interelectrode Capacitances (Approx.):		
Grid No.1 to Plate .....	0.5	pF
Grid No.1 to Cathode, Heater, Grid No.2, and Grid No.3 .....	23	pF
Plate to Cathode, Heater, Grid No.2, and Grid No.3 .....	11	pF
Plate Resistance (Approx.)*	5500	ohms
Transconductance*	10500	$\mu$ mhos
Mu-Factor, Grid No.2 to Grid No.1**	3.3	

\* The dc component must not exceed 100 volts.

\* For plate volts, 175; grid-No.2 volts, 125; grid-No.1 volts, -25; plate mA, 110; grid-No.2 mA, 5.

\*\* For plate and grid-No.2 volts, 125; grid-No.1 volts, -25.

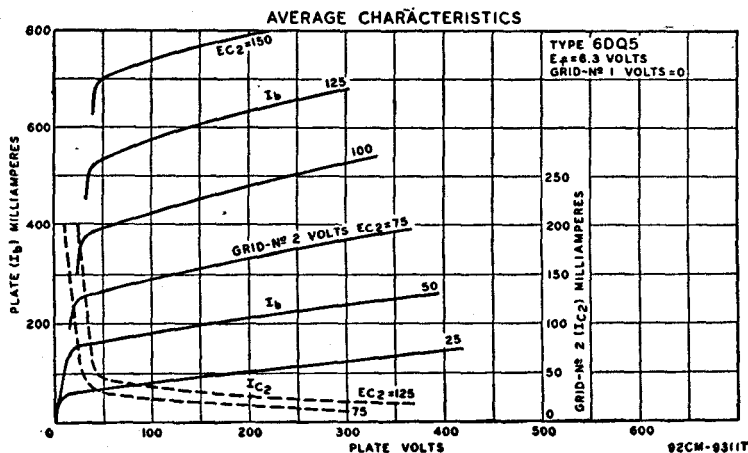
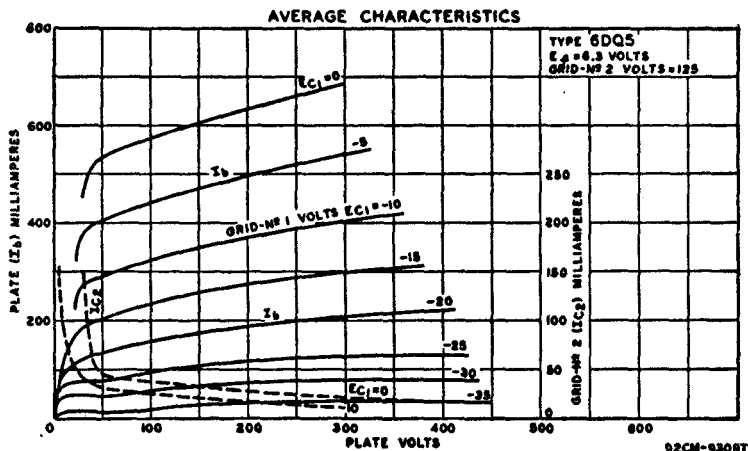

### Horizontal Deflection Amplifier

For operation in a 525-line, 30-frame system

#### MAXIMUM RATINGS (Design-Maximum Values):

DC Plate Voltage	990 max	volts
Peak Positive-Pulse Plate Voltage†	6500 max	volts
Peak Negative-Pulse Plate Voltage	-1100 max	volts
DC Grid-No.2 (Screen-Grid) Voltage	190 max	volts
Peak Negative-Pulse Grid-No.1 (Control-Grid) Voltage	-250 max	volts
Peak Cathode Current	1100 max	mA
Average Cathode Current	315 max	mA
Grid-No.2 Input	3.2 max	watts
Plate Dissipation#	24 max	watts
Bulb Temperature (At hottest point)	220 max	°C

#### MAXIMUM CIRCUIT VALUE:

Grid-No.1-Circuit Resistance:  
For grid-resistor-bias operation . . . . . 0.47 max megohm

† The duration of the voltage pulse must not exceed 15 per cent of one horizontal scanning cycle. In a 525-line, 30-frame system, 15 per cent of one horizontal scanning cycle is 10 microseconds.  
# An adequate bias resistor or other means is required to protect the tube in the absence of excitation.

### BEAM POWER TUBE

## 6DQ6B

Related types:  
12DQ6B, 17DQ6B

Glass octal type used as horizontal-deflection-amplifier tube in high-efficiency deflection circuits of television receivers. Outline 20, **Outlines** section. Tube requires octal socket and may be mounted in any position. This

type may be supplied with pin 1 omitted. Types 12DQ6B and 17DQ6B are identical with type 6DQ6B except for the heater ratings, as shown below.

	6DQ6B	12DQ6B	17DQ6B	
Heater Voltage (ac/dc)	6.3	12.6	16.8	volts
Heater Current	1.2	0.6	0.45	ampere
Heater Warm-up Time (Average)	—	11	11	seconds
Peak Heater-Cathode Voltage:				
Heater negative with respect to cathode	200 max	200 max	200 max	volts
Heater positive with respect to cathode	200□max	200□max	200□max	volts
Direct Interelectrode Capacitances (Approx.)				
Grid No.1 to Plate			0.5	pF
Grid No.1 to Cathode, Heater, Grid No.2, and Grid No.3			15	pF
Plate to Cathode, Heater, Grid No.2, and Grid No.3			7	pF

□ The dc component must not exceed 100 volts.

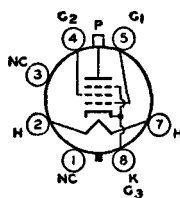

6AM

### Class A<sub>1</sub> Amplifier

#### CHARACTERISTICS:

Plate Voltage	60	250	volts
Grid-No.2 Voltage	150	150	volts
Grid-No.1 Voltage	0	-22.5	volts
Plate Resistance (Approx.)	—	18000	ohms
Transconductance	—	7300	
Plate Current	345*	65	mA
Grid-No.2 Current	27*	1.8	mA
Grid-No.1 Voltage (Approx.) for			
grid-No.2 volts = 150, plate mA = 1,			
plate volts = 250	—	-42	volts
plate volts = 5000	—	-100	volts

\* This value can be measured by a method involving a recurrent waveform such that the maximum ratings of the tube will not be exceeded.

### Horizontal-Deflection Amplifier

For operation in a 525-line, 30-frame system

#### MAXIMUM RATINGS (Design-Maximum Values):

DC Plate-Supply Voltage	770 max	volts
Peak Positive-Pulse Plate Voltage*	6500 max	volts



Peak Negative-Pulse Plate Voltage .....	-1500 max	volts
DC Grid-No.2 (Screen-Grid) Voltage .....	220 max	volts
Peak Negative-Pulse Grid-No.1 Voltage .....	-330 max	volts
Peak Cathode Current .....	610 max	mA
Average Cathode Current .....	175 max	mA
Grid-No.2 Input .....	3.6 max	watts
Plate Dissipation* .....	18 max	watts
Bulb Temperature (At hottest point) .....	220 max	°C

**MAXIMUM CIRCUIT VALUES:**

Grid-No.1-Circuit Resistance for grid-resistor-bias operation ..... 1 max megohm

\* The duration of the voltage pulse must not exceed 15 per cent of one horizontal scanning cycle. In a 525-line, 30-frame system, 15 per cent of one horizontal scanning cycle is 10 microseconds.

\* An adequate bias resistor or other means is required to protect the tube in the absence of excitation.

**DUAL TRIODE**

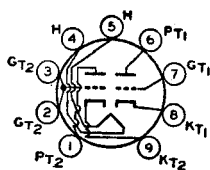

9HF

Miniature type containing high-mu and low-mu triodes; used as combined vertical-deflection-oscillator and vertical-deflection-amplifier tube in television receivers. Outline 6E, Outlines section. Tube requires miniature nine-

**6DR7**

Related types:  
10DR7, 13DR7

contact socket and may be operated in any position. Types 10DR7 and 13DR7 are identical with type 6DR7 except for the heater ratings, as shown below.

	6DR7	10DR7	13DR7	
Heater Voltage (ac/dc) .....	6.3	9.7	13	volts
Heater Current .....	0.9	0.6	0.45	ampere
Heater Warm-up Time (Average) .....	—	11	11	seconds
Peak Heater-Cathode Voltage:				
Heater negative with respect to cathode ..	200 max	200 max	200 max	volts
Heater positive with respect to cathode ..	200*max	200*max	200*max	volts
Direct Interelectrode Capacitances (Approx.):		Unit No.1	Unit No.2	
Grid to Plate .....		4.5	8.5	pF
Grid to Cathode and Heater .....		2.2	5.5	pF
Plate to Cathode and Heater .....		0.34	1	pF

\* The dc component must not exceed 100 volts.

**Class A<sub>1</sub> Amplifier**

**CHARACTERISTICS:**

	Unit No.1	Unit No.2	
Plate Voltage .....	250	150	volts
Grid Voltage .....	-3	-17.5	volts
Amplification Factor .....	68	6	
Plate Resistance (Approx.) .....	40000	925	ohms
Transconductance .....	1600	6500	μmhos
Grid Voltage (Approx.) for plate current of 10 μA ..	-5.5	—	volts
Grid Voltage (Approx.) for plate current of 50 μA ..	—	-44	volts
Plate Current .....	1.4	35	mA
Plate Current for grid voltage of -24 volts .....	—	10	mA

**Vertical-Deflection Oscillator and Amplifier**

For operation in a 525-line, 30-frame system

**MAXIMUM RATINGS (Design-Maximum Values):**

DC Plate Voltage .....	330 max	275 max	volts
Peak Positive-Pulse Plate Voltage# .....	—	1500 max	volts
Peak Negative-Pulse Grid Voltage .....	-400 max	-250 max	volts
Peak Cathode Current .....	70 max	175 max	mA
Average Cathode Current .....	20 max	50 max	mA
Plate Dissipation .....	1 max	7 max	watts

**MAXIMUM CIRCUIT VALUE:**

Grid-Circuit Resistance:

For grid-resistance-bias or cathode-bias operation ..... 2.2 max 2.2 max megohms

#The duration of the voltage pulse must not exceed 15 per cent of one vertical scanning cycle. In a 525-line, 30-frame system, 15 per cent of one vertical scanning cycle is 2.5 milliseconds.

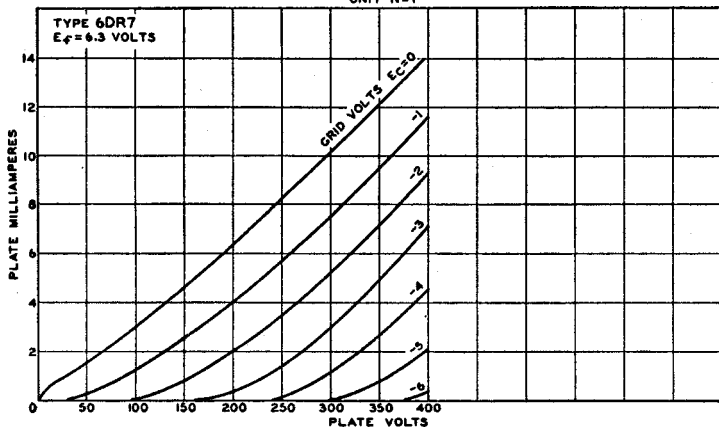
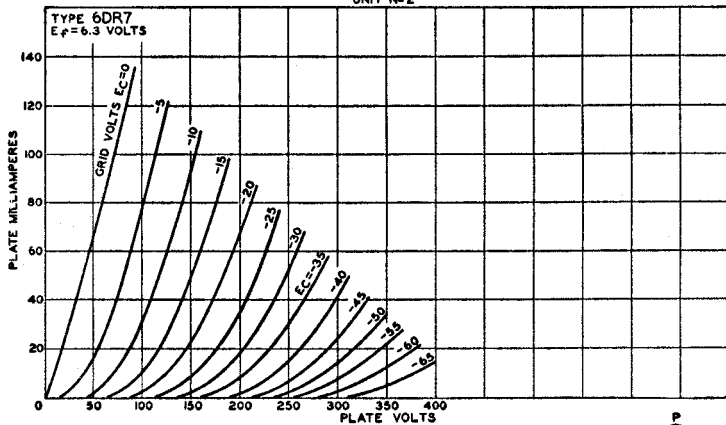
AVERAGE PLATE CHARACTERISTICS  
UNIT #1AVERAGE PLATE CHARACTERISTICS  
UNIT #2

92CM-9912T

## HIGH-MU TRIODE

Nuvistor type used as grounded-cathode, neutralized rf amplifier in vhf tuners of television and FM receivers. Because of its cutoff characteristics, the 6DS4 is used in circuits to reduce cross-modulation distortion. Outline

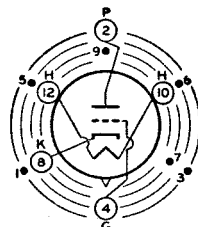
INDEX = LARGE LUG  
● = PIN CUT OFF

12AQ

## 6DS4

Related type:  
2DS4

1, **Outlines** section. Tube requires nuvistor socket and may be operated in any position. Type 2DS4 is identical with type 6DS4 except for the heater ratings, as shown below.

Heater Voltage (ac/dc) .....	2DS4	6DS4	
Heater Current .....	2.1	6.3	volts
Heater Warm-up Time (Average) .....	8	1.35	ampere
		—	seconds

Peak Heater-Cathode Voltage:

Heater negative with respect to cathode .....	100 max	100 max	volts
Heater positive with respect to cathode .....	100 max	100 max	volts

Direct Interelectrode Capacitances (Approx.):

Grid to Plate .....	0.92	pF
Grid to Cathode, Heater, and Shell .....	4.3	pF
Plate to Cathode, Heater, and Shell .....	1.8	pF
Plate to Cathode .....	0.18	pF
Heater to Cathode .....	1.6	pF

**Class A<sub>1</sub> Amplifier**

**MAXIMUM RATINGS (Design-Maximum Values):**

Plate Supply Voltage .....	300*max	volts
Plate Voltage .....	135 max	volts
Grid Voltage, Negative-bias value .....	55 max	volts
Grid Voltage, Peak Positive value .....	0 max	volts
Plate Dissipation .....	1.5 max	watt
Cathode Current .....	15 max	mA

**CHARACTERISTICS:**

Plate Supply Voltage .....	110	volts
Grid Supply Voltage .....	0	volts
Cathode-Bias Resistor .....	130	ohms
Amplification Factor .....	63	
Plate Resistance (Approx.) .....	7000	ohms
Transconductance .....	9000	μmhos
Plate Current .....	6.5	mA
Grid Voltage (Approx.) for plate current of 100 μA .....	-5	volts
Grid Voltage (Approx.) for plate current of 10 μA .....	-6.8	volts

**TYPICAL OPERATION:**

Plate Voltage .....	70	volts
Grid Supply Voltage .....	0	volts
Grid Resistor .....	47000	ohms
Amplification Factor .....	68	
Plate Resistance (Approx.) .....	5440	ohms
Transconductance .....	12500	μmhos
Plate Current .....	7	mA

AVERAGE PLATE CHARACTERISTICS

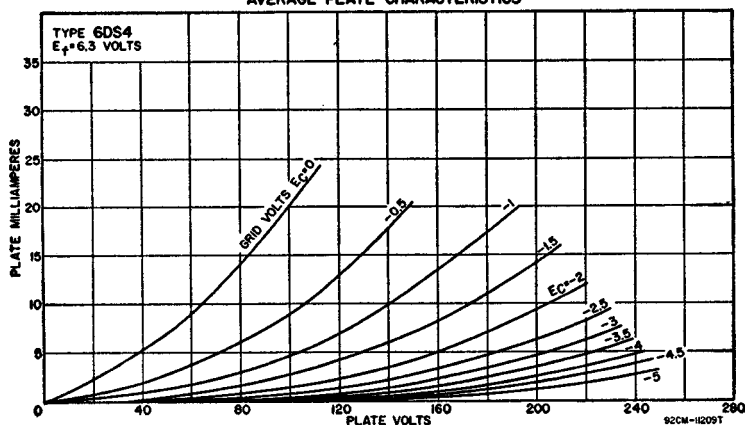

**MAXIMUM CIRCUIT VALUES:**

Grid-Circuit Resistance:*	
For fixed-bias operation .....	0.5 max megohm
For cathode-bias operation .....	2.2 max megohm

\* A plate supply voltage of 300 volts may be used provided a sufficiently large resistor is used in the plate circuit to limit the plate dissipation to 1.5 watts under any condition of operation.

• For operation at metal-shell temperatures up to 125°C.

## BEAM POWER TUBE

6DS5

Miniature type used in the audio output stages of television and radio receivers. Outline 5D, Outlines section. Tube requires miniature seven-contact socket and may be mounted in any position.

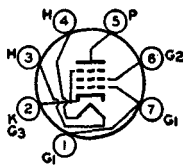

7BZ

Heater Voltage (ac/dc) .....	6.3	volts
Heater Current .....	0.8	ampere
Peak Heater-Cathode Voltage:		
Heater negative with respect to cathode .....	200 max	volts
Heater positive with respect to cathode .....	200 max	volts
Direct Interelectrode Capacitances (Approx.):		
Grid No.1 to Plate .....	0.19	pF
Grid No.1 to Cathode, Heater, Grid No.2, and Grid No.3 .....	9.5	pF
Plate to Cathode, Heater, Grid No.2, and Grid No.3 .....	6.3	pF

Class A<sub>1</sub> Amplifier

<b>MAXIMUM RATINGS (Design-Maximum Values):</b>		
Plate Voltage .....	275 max	volts
Grid-No.2 (Screen-Grid) Voltage .....	275 max	volts
Grid-No.1 (Control-Grid) Voltage, Positive bias value .....	0 max	volts
Plate Dissipation .....	9 max	watts
Grid-No.2 Input .....	2.2 max	watts
Bulb Temperature (At hottest point) .....	250 max	°C

## AVERAGE CHARACTERISTICS

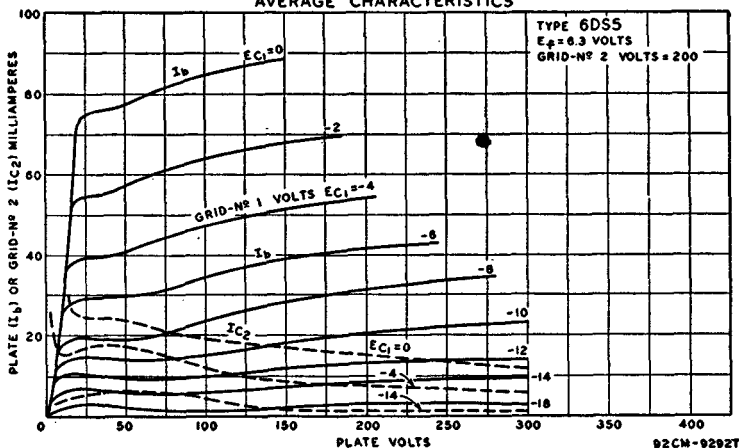

## TYPICAL OPERATION AND CHARACTERISTICS:

	Cathode-Bias Operation		Fixed-Bias Operation		
Plate Supply Voltage .....	200	200	200	250	volts
Grid-No.2 Supply Voltage .....	200	250	200	200	volts
Grid-No.1 Voltage .....	—	—	-7.5	-8.5	
Cathode-Bias Resistor .....	180	270	—	—	ohms
Peak AF Grid-No.1 Voltage .....	7.5	9.2	7.5	8.5	volts
Zero-Signal Plate Current .....	34.5	27	35	29	mA
Maximum-Signal Plate Current .....	32.5	25	36	32	mA
Zero-Signal Grid-No.2 Current .....	3.5	3	3	3	mA
Maximum-Signal Grid-No.2 Current .....	9	9	9	10	mA
Plate Resistance (Approx.) .....	28000	28000	28000	28000	ohms
Transconductance .....	6000	5800	6000	5800	μmhos
Load Resistance .....	6000	8000	6000	8000	ohms
Total Harmonic Distortion .....	10	10	9	10	per cent
Maximum-Signal Power Output .....	2.8	3.6	3	3.8	watts

**MAXIMUM CIRCUIT VALUES:**

Grid-No.1-Circuit Resistance:

For fixed-bias operation .....	0.1 max megohm
For cathode-bias operation .....	1.0 max megohm

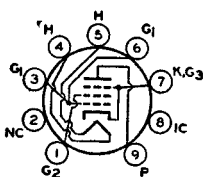

**9HN**

**BEAM POWER TUBE**

Miniature type used as a vertical-deflection-amplifier tube in television receivers employing 110-degree picture-tube systems. Outline 6E, **Outlines** section. Tube requires miniature nine-contact socket and may be operated

**6DT5**

Related type:  
12DT5

in any position. Type 12DT5 is identical with type 6DT5 except for the heater ratings, as shown below.

	<b>6DT5</b>	<b>12DT5</b>	
Heater Voltage (ac/dc) .....	6.3	12.6	volts
Heater Current .....	1.2	0.6	ampere
Heater Warm-up Time (Average) .....	—	11	seconds
Peak Heater-Cathode Voltage:			
Heater negative with respect to cathode .....	200 max	200 max	volts
Heater positive with respect to cathode .....	200*max	200*max	volts
Transconductance* .....		6200	μmhos

\* The dc component must not exceed 100 volts.

\* For plate and grid-No.2 volts, 250; grid-No.1 volts, -16.5; plate mA, 44; grid-No.2 mA, 1.5.

**Vertical-Deflection Amplifier**

For operation in a 525-line, 30-frame system

**MAXIMUM RATINGS (Design-Maximum Values):**

DC Plate Voltage .....	315 max	volts
Peak Positive-Pulse Plate Voltage# .....	2200 max	volts
Grid-No.2 (Screen-Grid) Voltage .....	285 max	volts
Peak Negative-Pulse Grid-No.1 (Control-Grid) Voltage .....	-250 max	volts
Peak Cathode Current .....	190 max	mA
Average Cathode Current .....	55 max	mA
Plate Dissipation .....	9 max	watts
Grid-No.2 Input .....	2 max	watts

**MAXIMUM CIRCUIT VALUES:**

Grid-No.1-Circuit Resistance:

For fixed-bias operation .....	0.5 max megohm
For cathode-bias operation .....	1 max megohm

# The duration of the voltage pulse must not exceed 15 per cent of one vertical scanning cycle. In a 525-line, 30-frame system, 15 per cent of one vertical scanning cycle is 2.5 milliseconds.

**SHARP-CUTOFF PENTODE**

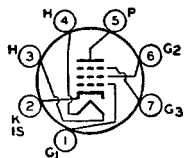

**7EN**

Miniature type used as FM detector in television receivers. Outline 5C, **Outlines** section. Tube requires miniature seven-contact socket and may be mounted in any position. Types 3DT6A and 4DT6A are identical with type 6DT6A except for the heater ratings, as shown below.

**6DT6A**

Related types:  
3DT6A, 4DT6A

	<b>3DT6A</b>	<b>4DT6A</b>	<b>6DT6A</b>	
Heater Voltage (ac/dc) .....	3.15	4.2	6.3	volts
Heater Current .....	0.6	0.45	0.3	ampere
Heater Warm-up Time (Average) .....	11	11	—	seconds
Peak Heater-Cathode Voltage:				
Heater negative with respect to cathode .....	200 max	200 max	200 max	volts
Heater positive with respect to cathode .....	200*max	200*max	200*max	volts

## Direct Interelectrode Capacitances (Approx.)\*

Grid No.1 to Plate .....	0.02	pF
Grid No.1 to Cathode, Heater, Grid No.2, Grid No.3, and Internal Shield .....	5.8	pF
Grid No.3 to Plate .....	1.7	pF
Grid No.1 to Grid No.3 .....	0.1	pF
Grid No.3 to Cathode, Heater, Grid No.1, Grid No.2, and Internal Shield .....	6.1	pF

- The dc component must not exceed 100 volts.
- External shield connected to cathode.

Class A<sub>1</sub> Amplifier

## CHARACTERISTICS:

Plate Supply Voltage .....	150	volts
Grid No.3 (Suppressor-Grid) .....	Connected to cathode at socket	
Grid-No.2 (Screen-Grid) Supply Voltage .....	100	volts
Cathode-Bias Resistor .....	560	ohms
Plate Resistance (Approx.) .....	0.15	megohm
Transconductance, Grid No.1 to Plate .....	1350	$\mu$ mhos
Transconductance, Grid No.3 to Plate .....	515	$\mu$ mhos
Plate Current .....	1.55	mA
Grid-No.2 Current .....	1.8	mA
Grid-No.1 Voltage (Approx.) for plate current of 10 $\mu$ A .....	-5.2	volts
Grid-No.3 Voltage (Approx.) for plate current of 10 $\mu$ A .....	-4.2	volts

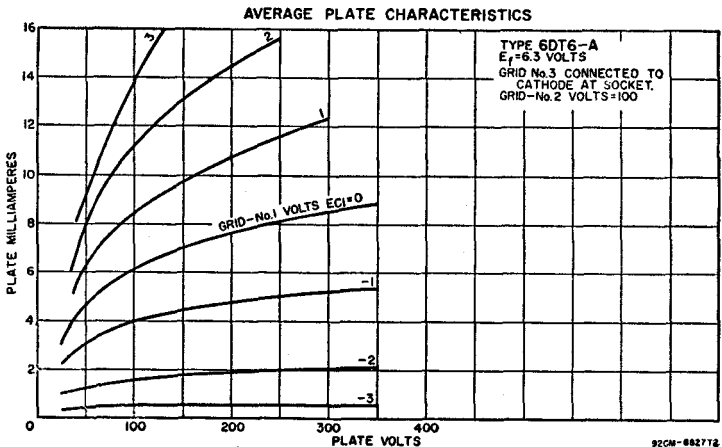

## FM Detector

## MAXIMUM RATINGS (Design-Maximum Values):

Plate Voltage .....	330 max	volts
Grid-No.3 Voltage .....	28 max	volts
Grid-No.2 Supply Voltage .....	330 max	volts
Grid-No.2 Voltage .....	See curve page 80	
Grid-No.1 (Control-Grid) Voltage, Positive-bias value .....	0 max	volts
Plate Dissipation .....	1.7 max	watts
Grid-No.2 Input:		
For grid-No.2 voltages up to 165 volts .....	1.1 max	watts
For grid-No.2 voltages between 165 and 330 volts .....	See curve page 80	

## MAXIMUM CIRCUIT VALUES:

Grid-No.1-Circuit Resistance:		
For fixed-bias operation .....	0.25 max	megohm
For cathode-bias operation .....	0.5 max	megohm

AVERAGE CHARACTERISTICS

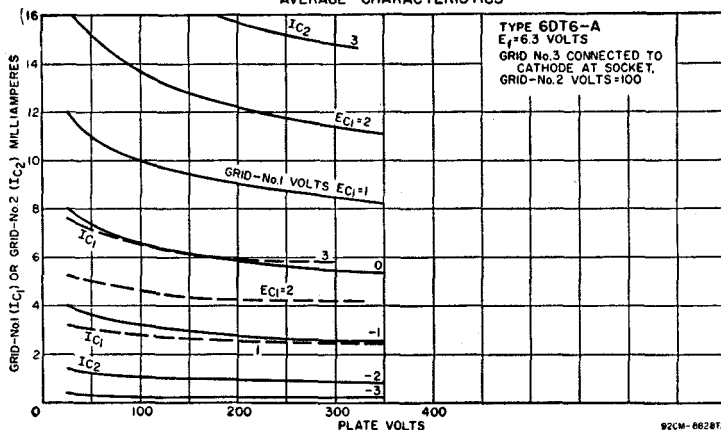

92CM-862818

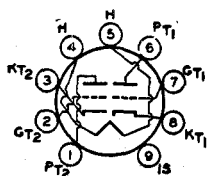

9AJ

HIGH-MU TWIN TRIODE

Miniature type used in a wide variety of applications in radio and television receivers. Especially useful in push-pull rf amplifiers or as frequency converter in FM tuners. Outline 6B, Outlines section. Tube requires min-

6DT8

Related type:  
12DT8

ature nine-contact socket and may be mounted in any position. Type 12DT8 is identical with type 6DT8 except for the heater ratings. Except for heater and heater-cathode ratings, interelectrode capacitances, and basing arrangement, these types are identical with miniature type 12AT7.

Heater Voltage (ac/dc) .....	6DT8 6.3	12DT8 12.6	volts
Heater Current .....	0.3	0.15	ampere
Peak Heater-Cathode Voltage:			
Heater negative with respect to cathode .....	200 max	200 max	volts
Heater positive with respect to cathode .....	200*max	200*max	volts
Direct Interelectrode Capacitances (Approx., Each Unit Except as Noted):			
Grid to Plate .....		1.6*	pF
Grid to Cathode, Heater, and Internal Shield .....		2.7*	pF
Plate to Cathode, Heater, and Internal Shield .....		1.6*	pF
Heater to Cathode .....		3*	pF
Cathode to Grid, Heater, and Internal Shield (Unit No.2) .....		5.3†	pF
Plate to Grid, Heater, and Internal Shield (Unit No.2) .....		2.8†	pF

- \* The dc component must not exceed 100 volts.
- † With external shield connected to grid of unit under test.
- With external shield connected to ground.
- With external shield connected to cathode of unit under test.

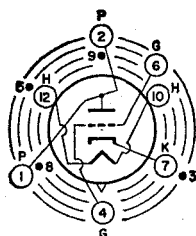

INDEX = LARGE LUG  
• = SHORT PIN

12EA

HIGH-MU TRIODE

Nuvistor type used at frequencies up to 1000 megacycles in uhf oscillator stages of television receivers. Outline 1, Outlines section. Tube requires nuvistor socket and may be mounted in any position. Type 2DV4 is identical

6DV4

Related type:  
2DV4

with type 6DV4 except for the heater ratings, as shown below.

	2DV4	6DV4	
Heater Voltage (ac/dc) .....	2.1	6.3	volts
Heater Current .....	0.45	0.135	ampere
Heater Warm-up Time (Average) .....	8	—	seconds
Peak Heater-Cathode Voltage:			
Heater negative with respect to cathode .....	100 max	100 max	volts
Heater positive with respect to cathode .....	100 max	100 max	volts
Direct Interelectrode Capacitance (Approx.):			
Grid to Plate .....		1.8	pF
Grid to Cathode, Heater, and Shell .....		4.4	pF
Plate to Cathode, Heater, and Shell .....		1.9	pF
Plate to Cathode .....		0.25	pF
Heater to Cathode .....		1.4	pF
Grid to Cathode .....		3.7	pF

### Class A<sub>1</sub> Amplifier

#### MAXIMUM RATINGS (Design-Maximum Values):

Plate Supply Voltage .....	300 max	volts
Plate Voltage .....	125 max	volts
Grid Voltage:		
Negative-bias value .....	-55 max	volts
Peak positive value .....	2 max	volts
Plate Dissipation .....	1 max	watt
Cathode Current .....	15 max	mA

#### CHARACTERISTICS:

Plate Supply Voltage .....	75	volts
Cathode-Bias Resistor .....	100	ohms
Amplification Factor .....	35	
Plate Resistance (Approx.) .....	3100	ohms
Transconductance .....	11500	$\mu$ mhos
Grid Voltage (Approx.) for plate current of 10 $\mu$ A .....	-7	volts
Plate Current .....	10.5	mA

#### TYPICAL OPERATION AS OSCILLATOR AT 950 Mc/s:

Plate Voltage .....	60	volts
Grid Voltage .....	-2	volts
Grid Resistor .....	5600	ohms
Plate Current .....	8	mA
Grid Current .....	350	$\mu$ A

#### MAXIMUM CIRCUIT VALUES:

Grid-Circuit Resistance:*		
For fixed-bias operation .....	0.1 max	megohm
For cathode-bias operation .....	0.2 max	megohm

\* For operation at metal-shell temperatures up to 135°C.

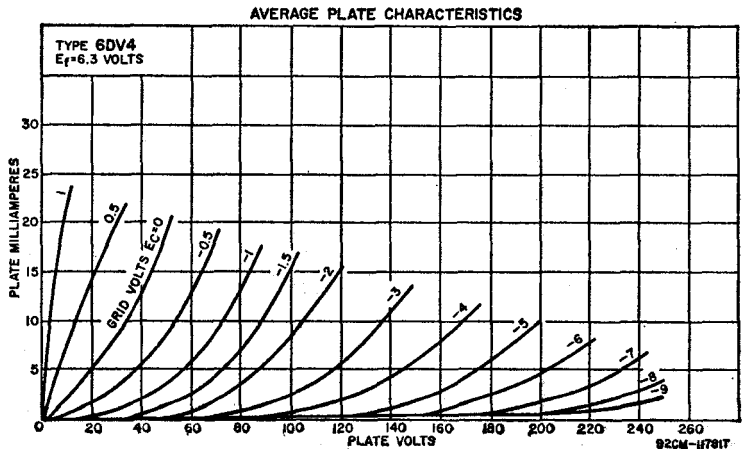



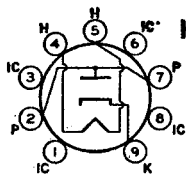

9HP

### HALF-WAVE VACUUM RECTIFIER

Novar types used as damper tubes in horizontal-deflection circuits of color and black-and-white television receivers. Outlines 11D and 30B, respectively, **Outlines** section. Tubes require novar nine-contact socket and may be

**6DW4**  
**6DW4B**

mounted in any position. Socket terminals 1, 3, 6, and 8 should not be used as tie points; it is recommended that socket clips for these pins be removed to reduce the possibility of arc-over and to minimize leakage. It is especially important that these tubes, like other power-handling tubes, be adequately ventilated.

Heater Voltage (ac/dc) .....	6.3	volts
Heater Current .....	1.2	amperes
Direct Interelectrode Capacitances (Approx.):		
Plate to Cathode and Heater: .....	6.5	pF
Cathode to Plate and Heater .....	9	pF
Heater to Cathode .....	2.8	pF

#### Damper Service

For operation in a 525-line, 30-frame system

#### MAXIMUM RATINGS (Design-Maximum Values):

Peak Inverse Plate Voltage° (6DW4) .....	5000 max	volts
Peak Inverse Plate Voltage° (6DW4B) .....	5000 max	volts
Peak Plate Current .....	1300 max	mA
DC Plate Current .....	250 max	mA
Plate Dissipation .....	8.5 max	watts
Peak Heater-Cathode Voltage:		
Heater negative with respect to cathode .....	5000*max	volts
Heater positive with respect to cathode .....	3000*max	volts

#### CHARACTERISTICS, Instantaneous Value:

Tube Voltage Drop for plate current of 350 mA .....	25	volts
---	----	-------

\* The duration of the voltage pulse must not exceed 15 per cent of one horizontal scanning cycle. In a 525-line, 30-frame system, 15 per cent of one horizontal scanning cycle is 10 microseconds.

- \* The dc component must not exceed 900 volts.
- \* The dc component must not exceed 100 volts.

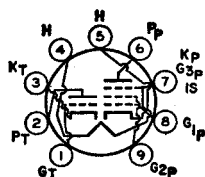

9HX

### HIGH-MU TRIODE— SHARP-CUTOFF PENTODE

Miniature type used in television-receiver applications. The triode unit is used as a sync-separator, sync-amplifier, keyed-agc, or noise-suppressor tube. The pentode unit is used as a video-output tube. Outline 6E, **Out-**

**6DX8**

Related type:  
10DX8

lines section. Tube requires miniature nine-contact socket and may be mounted in any position. Type 10DX8 is identical with type 6DX8 except for the heater ratings, as shown below.

	6DX8	10DX8	
Heater Voltage (ac/dc) .....	6.3	10.2	volts
Heater Current .....	0.72	0.45	ampere
Peak Heater-Cathode Voltage:			
Heater negative with respect to cathode .....	200 max	200 max	volts
Heater positive with respect to cathode .....	200 max	200 max	volts

#### Class A<sub>1</sub> Amplifier

<b>MAXIMUM RATINGS (Design-Center Values):</b>	Triode Unit	Pentode Unit	
Plate Supply Voltage .....	550 max	550 max	volts

Peak Plate Voltage, with maximum plate current of 0.1 mA .....	600 max	—	volts
Plate Voltage .....	300 max	300 max	volts
Grid-No.2 (Screen-Grid) Supply Voltage .....	—	550 max	volts
Grid-No.2 Voltage .....	—	300 max	volts
Cathode Current .....	12 max	40 max	mA
Grid-No.2 Input .....	—	1.7 max	watts
Plate Dissipation .....	1 max	4 max	watts

CHARACTERISTICS:	Triode Unit	Pentode Unit			
Plate Voltage .....	200	170	200	220	volts
Grid-No.2 Voltage .....	—	170	200	220	volts
Grid-No.1 Voltage .....	-1.7	-2.1	-2.9	-3.4	volts
Amplification Factor .....	65	—	—	—	
Mu-Factor, Grid-No.2 to Grid-No.1 .....	—	36	36	36	
Plate Resistance (Approx.) .....	—	0.1	0.13	0.15	megohm
Transconductance .....	4000	11000	10400	10000	$\mu$ mhos
Plate Current .....	3	18	18	18	mA
Grid-No.2 Current .....	—	3	3	3	mA

#### TYPICAL OPERATION OF PENTODE UNIT AS VIDEO OUTPUT TUBE:

Plate Supply Voltage .....	170	200	220	volts
Series Plate Resistor .....	3000	3000	3000	ohms
Grid-No.2 Voltage .....	170	200	220	volts
Grid-No.1 Voltage .....	-2	-2.8	-3.3	volts
Transconductance .....	10400	10000	9700	$\mu$ mhos
Plate Current .....	18	18	18	mA
Grid-No.2 Current .....	3.2	3.1	3.1	mA

#### MAXIMUM CIRCUIT VALUES:

Grid-No.1-Circuit Resistance:	Triode Unit	Pentode Unit
For fixed-bias operation .....	1 max	1 max megohm
For cathode-bias operation .....	3 max	2 max megohms

\* With maximum duty factor of 0.18 and maximum pulse duration of 18 microseconds.

## MEDIUM-MU TRIODE

### 6DZ4

Related types:  
2DZ4, 3DZ4

Miniature type used as a local-oscillator tube in uhf television receivers covering the frequency range from 470 to 890 megacycles. Outline 5B, **Outlines** section. Tube requires miniature seven-contact socket and may be

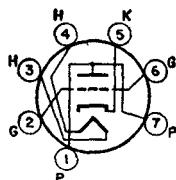

7DK

mounted in any position. For curve of average plate characteristics, refer to type 6AF4A. Types 2DZ4 and 3DZ4 are identical with type 6DZ4 except for the heater ratings, as shown below.

	2DZ4	3DZ4	6DZ4	
Heater Voltage (ac/dc) .....	2.35	3.2	6.3	volts
Heater Current .....	0.6	0.45	0.225	ampere
Heater Warm-up Time (Average) .....	11	11	—	seconds
Peak Heater-Cathode Voltage:				
Heater negative with respect to cathode .....	180 max	180 max	50	volts
Heater positive with respect to cathode .....	180*max	180*max	50*	volts
Direct Interelectrode Capacitances (Approx.):*				
Grid to Plate .....			1.8	pF
Grid to Cathode and Heater .....			2.2	pF
Plate to Cathode and Heater .....			1.3	pF

- \* The dc component must not exceed 100 volts.
- \* The dc component must not exceed 25 volts.
- \* With external shield connected to cathode.

## Class A<sub>1</sub> Amplifier

CHARACTERISTICS:		
Plate Supply Voltage .....	80	volts
Plate Resistor .....	2700	ohms
Amplification Factor .....	14	

Plate Resistance (Approx.) .....	2000	ohms
Transconductance .....	6700	$\mu$ mhos
Plate Current .....	15	mA
Grid Voltage (Approx.) for plate current of 20 $\mu$ A .....	-11	volts

**UHF Oscillator**

<b>MAXIMUM RATINGS (Design-Maximum Values):</b>		
Plate Voltage .....	135 max	volts
Grid Voltage, Negative-bias value .....	-50 max	volts
Grid Current .....	2 max	mA
Cathode Current .....	20 max	mA
Plate Dissipation .....	2.3 max	watts

**TYPICAL OPERATION AS OSCILLATOR AT 1000 Mc/s:**

Plate Supply Voltage .....	135	volts
Plate-Circuit Resistance .....	2700	ohms
Grid Resistor .....	10000	ohms
Plate Current .....	15.5	mA
Grid Current (Approx.) .....	800	$\mu$ A

**MAXIMUM CIRCUIT VALUES:**

Grid-Circuit Resistance:		
For fixed-bias operation .....		Not recommended
For cathode-bias operation .....		0.5 max megohm

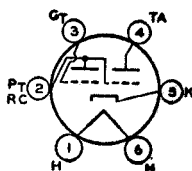

**6R**

**ELECTRON-RAY TUBE**

Glass type used to indicate visually by means of a fluorescent target the effects of a change in a controlling voltage. It is used as a convenient means of indicating accurate radio-receiver tuning. Outline 13H, **Outlines**

**6E5**

section. Tube requires six-contact socket. Heater volts (ac/dc), 6.3; amperes, 0.3. For additional considerations, refer to **Tuning Indication with Electron-Ray Tubes** in **Electron Tube Applications** section.

**Tuning Indicator**

<b>MAXIMUM AND MINIMUM RATINGS (Design-Center Values):</b>		
Plate-Supply Voltage .....	250 max	volts
Target Voltage .....	250 max	volts
	125 min	volts

**TYPICAL OPERATION:**

Plate and Target Supply Voltage .....	200	250	volts
Series Triode-Plate Resistor .....	1	1	megohm
Target Current*† .....	3	4	mA
Triode-Plate Current* .....	0.19	0.24	mA
Triode-Grid Voltage (Approx.):			
For shadow angle of 0° .....	-6.5	-8.0	volts
For shadow angle of 90° .....	0	0	volts

\* For zero triode-grid voltage.

† Subject to wide variations.

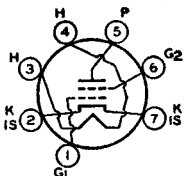

**7E5**

**SHARP-CUTOFF TETRODE**

Miniature type used as rf amplifier in vhf tuners of television receivers. Outline 5C, **Outlines** section. Tube requires miniature seven-contact socket and may be operated in any position. Type 3EA5 is identical with type

**6EA5**

Related type:  
3EA5

6EA5 except for the heater ratings, as shown below.			
	3EA5	6EA5	
Heater Voltage (ac/dc) .....	2.9	6.3	volts
Heater Current .....	0.45	0.2	ampere
Heater Warm-up Time (Average) .....	11	-	seconds

**Peak Heater-Cathode Voltage:**

Heater negative with respect to cathode .....	200 max	200 max	volts
Heater positive with respect to cathode .....	200*max	200*max	volts

**Direct Interelectrode Capacitances:**

Grid No.1 to Plate .....	Without External Shield	With External Shield*	
Grid No.1 to Cathode, Heater, Grid No.2, and Internal Shield .....	0.06 max	0.05 max	pF
Plate to Cathode, Heater, Grid No.2, and Internal Shield .....	3.8	4.5	pF
	2.3	3	pF

\* The dc component must not exceed 100 volts.

\* With external shield connected to cathode.

**Class A<sub>1</sub> Amplifier**

**MAXIMUM RATINGS (Design-Maximum Values):**

Plate Voltage .....	250 max	volts
Grid-No.2 (Screen-Grid) Voltage .....	150 max	volts
Grid-No.1 (Control-Grid) Voltage, Positive-bias value .....	0 max	volts
Cathode Current .....	20 max	mA
Grid-No.2 Input .....	0.5 max	watt
Plate Dissipation .....	3.25 max	watts

**CHARACTERISTICS:**

Plate Voltage .....	250	volts
Grid-No.2 Voltage .....	140	volts
Grid-No.1 Voltage .....	-1	volt
Plate Resistance (Approx.) .....	0.15	megohm
Transconductance .....	8000	μmhos
Plate Current .....	10	mA
Grid-No.2 Current .....	0.95	mA
Grid-No.1 Voltage (Approx.) for transconductance of 100 μmhos or less .....	-6	volts

**DUAL TRIODE**

**6EA7**

Glass octal type containing high-mu triode and high-perveance, low-mu triode in same envelope. Used as a combined vertical deflection oscillator and vertical deflection amplifier in television receivers. Outline 13B, Out-

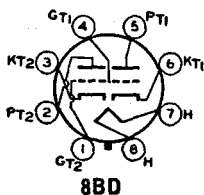

lines section. Tube requires octal socket and may be operated in any position. Heater volts (ac/dc), 6.3; amperes, 1.05; peak heater-cathode volts, 200 (the dc component must not exceed 100 volts when the heater is positive with respect to the cathode).

**Class A<sub>1</sub> Amplifier**

**CHARACTERISTICS:**

	Unit No.1	Unit No.2	
Plate Voltage .....	250	60 175	volts
Grid Voltage .....	-3	0 -25	volts
Amplification Factor .....	66	- 5.5	
Plate Resistance (Approx.) .....	30000	- 920	ohms
Transconductance .....	2200	- 6000	μmhos
Grid Voltage (Approx.):			
For plate current of 20 μA .....	-5.3	- -	volts
For plate current of 200 μA .....	-	- -45	volts
Plate Current .....	2	100* 40	mA

\* This value can be measured by a method involving a recurrent waveform such that the maximum ratings of the tube will not be exceeded.

**Vertical-Deflection Oscillator and Amplifier**

For operation in a 525-line, 30-frame system

	Unit No.1	Unit No.2	
<b>MAXIMUM RATINGS (Design-Maximum Values):</b>	Oscillator	Amplifier	
DC Plate Voltage .....	350 max	550 max	volts
Peak Positive-Pulse Plate Voltage° .....	-	1500 max	volts

	Unit No.1	Unit No.2	
Peak Negative-Pulse Grid Voltage .....	Oscillator	Amplifier	
Peak Cathode Current .....	-400 max	-250 max	volts
Average Cathode Current .....	—	175 max	mA
Plate Dissipation .....	1 max	50 max	mA
		10 max	watts

**MAXIMUM CIRCUIT VALUES:**

Grid-Circuit Resistance:		
For grid-resistor-bias operation .....	1 max	1 max megohm
For cathode-bias operation .....	2.2 max	2.2 max megohms

\* The duration of the voltage pulse must not exceed 15 per cent of one vertical scanning cycle. In a 525-line, 30-frame system, 15 per cent of one vertical scanning cycle is 2.5 milliseconds.

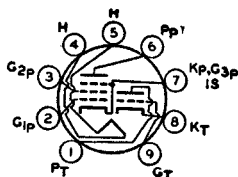

**MEDIUM-MU TRIODE—  
SHARP-CUTOFF PENTODE**

Miniature type used as combined oscillator and mixer in television receivers utilizing an intermediate frequency in the order of 40 megacycles per second. Outline 6B, Outlines section. Tube requires miniature nine-contact

**6EA8**

Related types:  
5EA8, 9EA8, 19EA8

**9AE** socket and may be mounted in any position. Types 5EA8, 9EA8, and 19EA8 are identical with type 6EA8 except for the heater ratings, as shown below.

	5EA8	6EA8	9EA8	19EA8	
Heater Voltage (ac/dc) .....	4.7	6.3	9.5	18.9	volts
Heater Current .....	0.6	0.45	0.3	0.15	ampere
Heater Warm-up Time (Average) ....	11	11	11	11	seconds

Peak Heater-Cathode Voltage:					
Heater negative with respect to cathode .....	200 max	200 max	200 max	200 max	volts
Heater positive with respect to cathode .....	200*max	200*max	200*max	200*max	volts

**Direct Interelectrode Capacitances:**

<b>Triode Unit:</b>	Without External Shield	With External Shield*	
Grid to Plate .....	1.7	1.7	pF
Grid to Cathode, Heater, Pentode Cathode, Pentode Grid No.3, and Internal Shield .....	3	3.2	pF
Plate to Cathode, Heater, Pentode Cathode, Pentode Grid No.3, and Internal Shield .....	1.4	1.9	pF
Cathode to Heater .....	3	3*	pF
<b>Pentode Unit:</b>			
Grid No.1 to Plate .....	0.02 max	0.01 max	pF
Grid No.1 to Cathode, Heater, Grid No.2, Grid No.3, and Internal Shield .....	5	5	pF
Plate to Cathode, Heater, Grid No.2, Grid No.3, and Internal Shield .....	2.6	3.4	pF
Heater to Cathode .....	3	3*	pF

- \* The dc component must not exceed 100 volts.
- \* With external shield connected to cathode of unit under test except as noted.
- \* With external shield connected to ground.

**Class A<sub>1</sub> Amplifier**

**MAXIMUM RATINGS (Design-Maximum Values):**

Plate Voltage .....	Triode Unit	Pentode Unit	
Grid-No.2 (Screen-Grid) Supply Voltage .....	330 max	330 max	volts
Grid-No.2 Voltage .....	—	330 max	volts
Grid-No.1 Voltage .....	—	See curve page 80	
Grid-No.1 (Control-Grid) Voltage, Positive-bias value .....	0 max	0 max	volts
Plate Dissipation .....	2.5 max	3.1 max	watts
Grid-No.2 Input:			
For grid-No.2 voltages up to 165 volts .....	—	0.55 max	watt
For grid-No.2 voltages between 165 and 330 volts .....	—	See curve page 80	

**CHARACTERISTICS:**

Plate Supply Voltage .....	150	125	volts
Grid-No.2 Voltage .....	—	125	volts

Grid-No.1 Voltage .....	—	Pentode Unit	—1	volt
Cathode-Bias Resistor .....	56	—	—	ohms
Amplification Factor .....	40	—	—	—
Plate Resistance (Approx.) .....	5000	200000	—	ohms
Transconductance .....	8500	6400	—	$\mu$ mhos
Plate Current .....	18	12	—	mA
Grid-No.2 Current .....	—	4	—	mA
Grid-No.1 Voltage for plate current of 10 $\mu$ A .....	—12	—9	—	volts

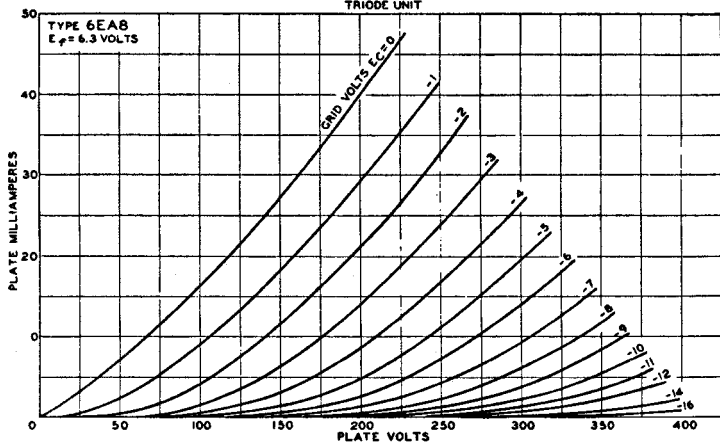
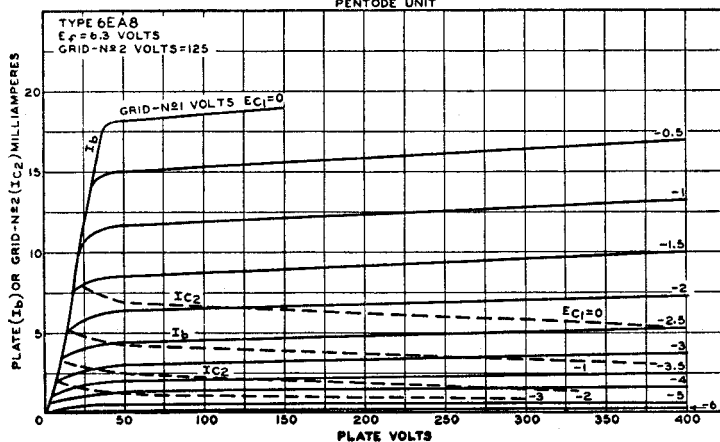
AVERAGE PLATE CHARACTERISTICS  
TRIODE UNITAVERAGE CHARACTERISTICS  
PENTODE UNIT

### HIGH-MU TRIODE— SHARP-CUTOFF PENTODE

## 6EB8

Related type:  
8EB8

Miniature type used in color and black-and-white television receivers. Pentode unit is used as video output amplifier; triode unit is used in sync-separator, sync-clipper, and phase-inverter circuits. Outline 6E, Outlines

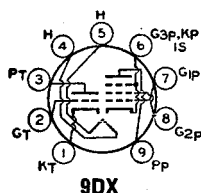

section. Tube requires miniature nine-contact socket and may be mounted in any position. Type 8EB8 is identical with type 6EB8 except for the heater ratings, as shown below.

	6EB8	8EB8	
Heater Voltage (ac/dc)	6.3	8	volts
Heater Current	0.75	0.6	ampere
Heater Warm-up Time (Average)	—	11	seconds
Peak Heater-Cathode Voltage:			
Heater negative with respect to cathode	200 max	200 max	volts
Heater positive with respect to cathode	200 <sup>o</sup> max	200 <sup>o</sup> max	volts
Direct Interelectrode Capacitances:			
Triode Unit:			
Grid to Plate		4.4	pF
Grid to Cathode and Heater		2.4	pF
Plate to Cathode and Heater		0.36	pF
Pentode Unit:			
Grid No.1 to Plate		0.1 max	pF
Grid No.1 to Cathode, Heater, Grid No.2, Grid No.3, and Internal Shield		11	pF
Plate to Cathode, Heater, Grid No.2, Grid No.3, and Internal Shield		4.2	pF
Triode Grid to Pentode Plate		0.018 max	pF
Pentode Grid No.1 to Triode Plate		0.005 max	pF
Pentode Plate to Triode Plate		0.17 max	pF

\* The dc component must not exceed 100 volts.

**Class A<sub>1</sub> Amplifier**

	Triode Unit	Pentode Unit	
<b>MAXIMUM RATINGS (Design-Maximum Values):</b>			
Plate Voltage	330 max	330 max	volts
Grid-No.2 (Screen-Grid) Supply Voltage	—	330 max	volts
Grid-No.2 Voltage	—	See curve page 80	
Grid-No.1 (Control-Grid) Voltage, Positive-bias value	0 max	0 max	volts
Plate Disipation	1 max	5 max	watts
Grid-No.2 Input:			
For grid-No.2 voltages up to 165 volts	—	1.1 max	watts
For grid-No.2 voltages between 165 and 330 volts	—	See curve page 80	

**CHARACTERISTICS:**

Plate Supply Voltage	250	200	volts
Grid-No.2 Supply Voltage	—	125	volts
Grid Voltage	-2	—	volts
Cathode-Bias Resistor	—	68	ohms
Amplification Factor	100	—	

AVERAGE PLATE CHARACTERISTICS  
TRIODE UNIT

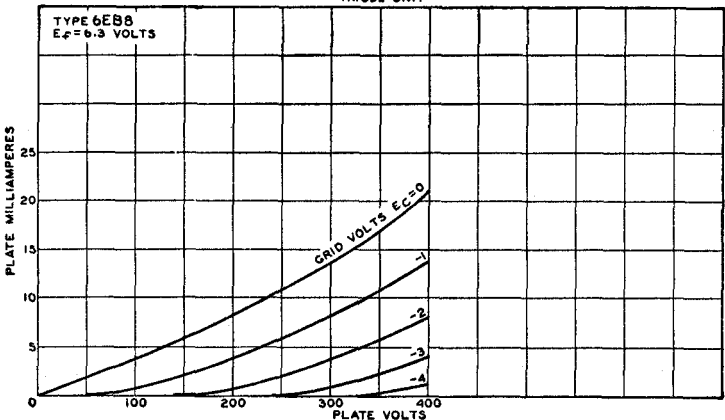
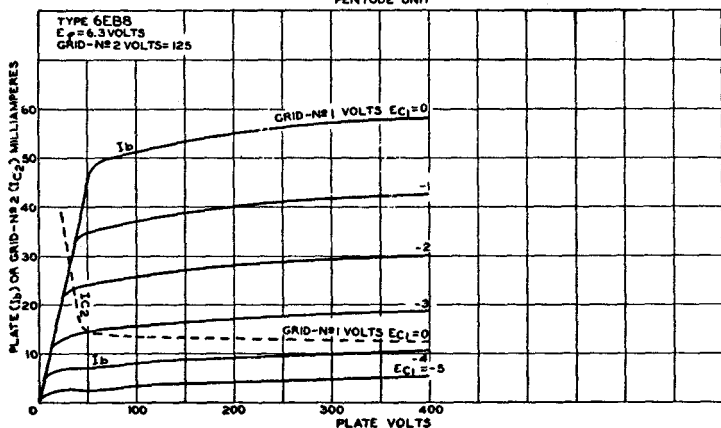

Plate Resistance (Approx.)	37000	75000	ohms
Transconductance	2700	12500	$\mu$ mhos
Grid Voltage (Approx.) for plate current of 20 $\mu$ A	-5	-	volts
Grid-No. 1 Voltage (Approx.) for plate current of 100 $\mu$ A	-	-9	volts
Plate Current	2	25	mA
Grid-No.2 Current	-	7	mA

**MAXIMUM CIRCUIT VALUES:**

Grid-No.1-Circuit Resistance:			
For fixed-bias operation	0.5 max	0.25 max megohm	
For cathode-bias operation	1.0 max	1.0 max megohm	

**AVERAGE CHARACTERISTICS**  
PENTODE UNIT**POWER PENTODE****6EH5**

Related types:

12EH5, 25EH5, 50EH5

Miniature type used in the audio output stage of radio and television receivers and in phonographs. This type has unusually high power sensitivity and is capable of providing relatively high power output at low plate and

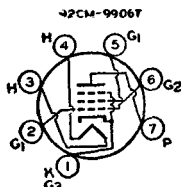

7CV

screen-grid voltages with a low af grid-No. 1 driving voltage. Outline 5D, **Outlines** section. Tube requires miniature seven-contact socket and may be mounted in any position. Types 12EH5, 25EH5, and 50EH5 are identical with type 6EH5 except for the heater ratings, as shown below.

	6EH5	12EH5	25EH5	50EH5	
Heater Voltage (ac/dc)	6.3	12.6	25	50	volts
Heater Current	1.2	0.6	0.3	0.15	ampere
Heater Warm-up Time (Average)	-	11	-	-	seconds
<b>Peak Heater-Cathode Voltage:</b>					
Heater negative with respect to cathode	200 max	300 max	200 max	200 max	volts
Heater positive with respect to cathode	200 max	200 max	200 max	200 max	volts
<b>Direct Interelectrode Capacitances (Approx.):</b>					
Grid No.1 to Plate	-	-	-	0.65	pF
Grid No.1 to Cathode, Heater, Grid No.2, and Grid No.3	-	-	-	17	pF
Plate to Cathode, Heater, Grid No.2, and Grid No.3	-	-	-	9	pF

\* The dc component must not exceed 100 volts.

**Class A<sub>1</sub> Amplifier****MAXIMUM RATINGS (Design-Maximum Values):**

Plate Voltage	150 max	volts
Grid-No.2 (Screen-Grid) Voltage	130 max	volts



Plate Dissipation .....	5.5 max	watts
Grid-No.2 Input .....	2 max	watts
Bulb Temperature (at hottest point) .....	220 max	°C

**TYPICAL OPERATION:**

Plate Supply Voltage .....	110	volts
Grid-No.2 Supply Voltage .....	115	volts
Cathode-Bias Resistor .....	62	ohms
Peak AF Grid-No.1 Voltage .....	3	volts
Zero-Signal Plate Current .....	42	mA
Maximum-Signal Plate Current .....	42	mA
Zero-Signal Grid-No.2 Current .....	11.5	mA
Maximum-Signal Grid-No.2 Current .....	14.5	mA
Plate Resistance (Approx.) .....	11000	ohms
Transconductance .....	14600	μmhos
Load Resistance .....	3000	ohms
Total Harmonic Distortion .....	7	per cent
Maximum-Signal Power Output .....	1.4	watts

**MAXIMUM CIRCUIT VALUES:**

Grid-No.1-Circuit Resistance:	
For fixed-bias operation .....	0.1 max megohm
For cathode-bias operation .....	0.5 max megohm

**Push-Pull Class AB<sub>1</sub> Audio-Frequency Power Amplifier**

**MAXIMUM RATINGS:** (Same as for class A<sub>1</sub> audio-frequency power amplifier)

**TYPICAL OPERATION** (Values are for 2 tubes):

Plate Supply Voltage .....	140	volts
Grid-No.2 Supply Voltage .....	120	volts
Cathode-Bias Resistor .....	68	ohms
Peak AF Grid-No.1 Voltage .....	9.4	volts
Zero-Signal Plate Current .....	47	mA
Maximum-Signal Plate Current .....	51	mA
Zero-Signal Grid-No.2 Current .....	11	mA
Maximum-Signal Grid-No.2 Current .....	17.7	mA
Effective Load Resistance (Plate-to-plate) .....	6000	ohms
Total Harmonic Distortion .....	5	per cent
Maximum-Signal Power Output .....	3.8	watts

**MAXIMUM CIRCUIT VALUES:**

Grid-No.1-Circuit Resistance:	
For fixed-bias operation .....	0.1 max megohm
For cathode-bias operation .....	0.5 max megohm

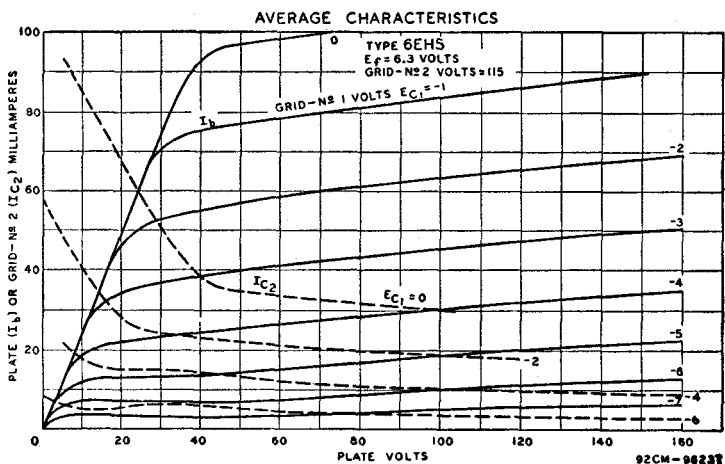

**6EH7**

**SEMIREMOTE-CUTOFF  
PENTODE**

**6EH7/  
EF183**

**Related types:  
3EH7, 4EH7**

Miniature types used as if-amplifier tubes in television receivers. Outline 6C, **Outlines** section. Tubes require miniature nine-contact socket and may be mounted in any position. Types 3EH7 and 4EH7 are identical with

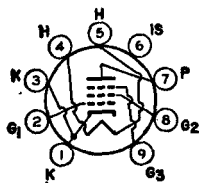

**9AQ**

types 6EH7 and 6EH7/EF183 except for the heater ratings, as shown below.

	3EH7	4EH7	6EH7 6EH7/ EF183	volts ampere
Heater Voltage (ac/dc)	3.4	4.4	6.3	
Heater Current	0.6	0.45	0.3	
<b>Peak Heater-Cathode Voltage:</b>				
Heater negative with respect to cathode	150 max	150 max	150 max	volts
Heater positive with respect to cathode	150 max	150 max	150 max	volts
<b>Direct Interelectrode Capacitances:</b>				
Grid No.1 to Plate			0.005 max	pF
Grid No.1 to Cathode, Heater, Grid No.2, Grid No.3, and Internal Shield			9	pF
Plate to Cathode, Heater, Grid No.2, Grid No.3, and Internal Shield			3	pF

**Class A<sub>1</sub> Amplifier**

**MAXIMUM RATINGS (Design-Center Values):**

Plate Supply Voltage	550 max	volts
Plate Voltage	250 max	volts
Grid-No.3 (Suppressor-Grid) Voltage, Positive value	0 max	volts
Grid-No.2 (Screen-Grid) Supply Voltage	550 max	volts
Grid-No.2 Voltage	250 max	volts
Cathode Current	20 max	mA
Grid-No.2 Input	0.65 max	watt
Plate Dissipation	2.5 max	watts

**CHARACTERISTICS:**

Plate Voltage	200	volts
Grid No.3	Connected to cathode at socket	volts
Grid-No.2 Voltage	90	volts
Grid-No.1 Voltage	-2	volts
Plate Resistance (Approx.)	0.5	megohm
Transconductance	12500	μmhos
Plate Current	12	mA
Grid-No.2 Current	4.5	mA

**TYPICAL OPERATION:**

Plate Voltage	200	200	200	200	volts
Grid No.3	Connected to cathode at socket				
Grid-No.2 Supply Voltage	200	200	200	200	volts
Grid-No.2 Series Resistor	22000	22000	22000	22000	ohms
Grid-No.1 Voltage	-19.5	-9.5	-6.5	-2	volts
Transconductance	125	625	1250	12500	μmhos
RMS Grid-No.1 Voltage, for cross-modulation factor of 0.01	450	160	100	—	mV

**MAXIMUM CIRCUIT VALUES:**

Grid-No.1-Circuit Resistance	1 max	megohm
------------------------------	-------	--------

**6EJ7**

**SHARP-CUTOFF PENTODE**

**6EJ7/  
EF184**

**Related types:  
3EJ7, 4EJ7**

Miniature types used as if-amplifier tubes in television receivers. Outline 6C, **Outlines** section. Tubes require miniature nine-contact socket and may be mounted in any position. Types 3EJ7 and 4EJ7 are identical with

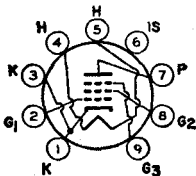

**9AQ**

with types 6EJ7 and 6EJ7/EF184 except for the heater ratings, as shown below.

	3EJ7	4EJ7	6EJ7 6EJ7/ EF184	
Heater Voltage (ac/dc) .....	3.4	4.4	6.3	volts
Heater Current .....	0.6	0.45	0.3	ampere
<b>Peak Heater-Cathode Voltage:</b>				
Heater negative with respect to cathode ...	150 max	150 max	150 max	volts
Heater positive with respect to cathode ...	150 max	150 max	150 max	volts
<b>Direct Interelectrode Capacitances:</b>				
Grid No.1 to Plate .....			0.005 max	pF
Grid No.1 to Cathode, Heater, Grid No.2, Grid No.3, and Internal Shield .....			10	pF
Plate to Cathode, Heater, Grid No.2, Grid No.3, and Internal Shield .....			3	pF

**Class A<sub>1</sub> Amplifier**

**MAXIMUM RATINGS (Design-Center Values):**

Plate Supply Voltage .....	550 max	volts
Plate Voltage .....	250 max	volts
Grid-No.2 (Screen-Grid) Supply Voltage .....	550 max	volts
Grid-No.2 Voltage .....	250 max	volts
Cathode Current .....	25 max	mA
Grid-No.2 Input .....	0.9 max	watt
Plate Dissipation .....	2.5 max	watts

**CHARACTERISTICS:**

Plate Voltage .....	190	200	volts
Grid No.3 .....	Connected to cathode at socket		
Grid-No.2 Voltage .....	190	200	volts
Grid-No.1 Voltage .....	-2.35	-2.5	volts
Plate Resistance (Approx.) .....	0.35	0.35	megohm
Transconductance .....	15000	15000	μmhos
Plate Current .....	10	10	mA
Grid-No.2 Current .....	4.1	4.1	mA

**MAXIMUM CIRCUIT VALUES:**

Grid-No.1-Circuit Resistance .....	1 max	megohm
------------------------------------	-------	--------

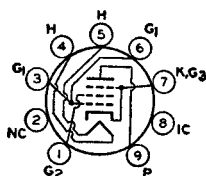

**9HN**

**BEAM POWER TUBE**

Miniature type used as vertical deflection amplifier in television receivers utilizing picture tubes having diagonal deflection angles of 110 degrees. Outline 6G, **Outlines** section.

Tube requires miniature nine-contact socket and may be mounted in any position. Type 8EM5 is identical with type 6EM5 except for the heater ratings, as shown below.

	6EM5	8EM5	
Heater Voltage (ac/dc) .....	6.3	8.4	volts
Heater Current .....	0.8	0.6	ampere
Heater Warm-up Time (Average) .....	—	11	seconds
<b>Peak Heater-Cathode Voltage:</b>			
Heater negative with respect to cathode .....	200 max	200 max	volts
Heater positive with respect to cathode .....	200*max	200*max	volts
<b>Direct Interelectrode Capacitances:</b>			
Grid No.1 to Plate .....		0.7 max	pF
Grid No.1 to Cathode, Heater, Grid No.2, and Grid No.3 .....		10	pF
Plate to Cathode, Heater, Grid No.2, and Grid No.3 .....		5.1	pF
Plate Resistance (Approx.)* .....		0.05	megohm
Transconductance* .....		5100	μmhos

\* The dc component must not exceed 100 volts.

\* For plate and grid-No.2 volts, 250; grid-No.1 volts, -18; plate mA, 40; grid-No.2 mA, 3.

**6EM5**

Related type:  
8EM5

**Vertical Deflection Amplifier**

For operation in a 525-line, 30-frame system

**MAXIMUM RATINGS** (Design-Center Values):

DC Plate Voltage .....	315 max	volts
Peak Positive-Pulse Plate Voltage† (Absolute Maximum) .....	2200 <sup>▲</sup> max	volts
Grid-No.2 (Screen-Grid) Voltage .....	285 max	volts
Peak Negative-Pulse Grid-No.1 (Control-Grid) Voltage .....	-250 max	volts
Peak Cathode Current .....	210 max	mA
Average Cathode Current .....	60 max	mA
Plate Dissipation .....	10 max	watts
Grid-No.2 Input .....	1.5 max	watts
Bulb Temperature (at hottest point) .....	250 max	°C

**MAXIMUM CIRCUIT VALUES:**

Grid-No.1-Circuit Resistance ..... 2.2 max megohm

<sup>▲</sup> Under no circumstances should this absolute value be exceeded.

† The duration of the voltage pulse must not exceed 15 per cent of one vertical scanning cycle. In a 525-line, 30-frame system, 15 per cent of one vertical scanning cycle is 2.5 milliseconds.

**AVERAGE CHARACTERISTICS**

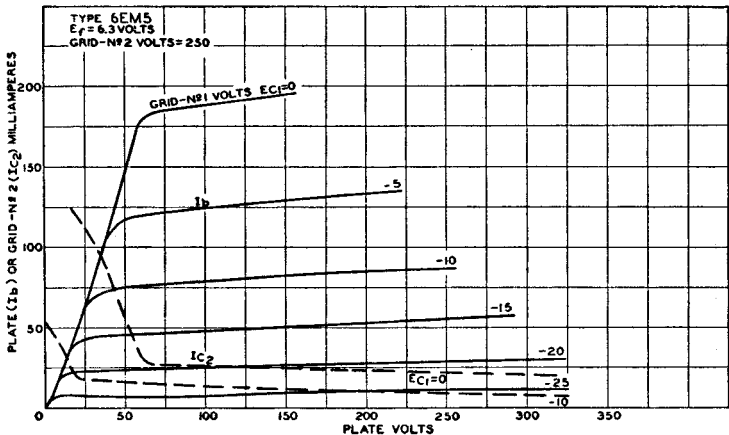

92CM-9797T1

**AVERAGE CHARACTERISTICS WITH EC2 AS VARIABLE**

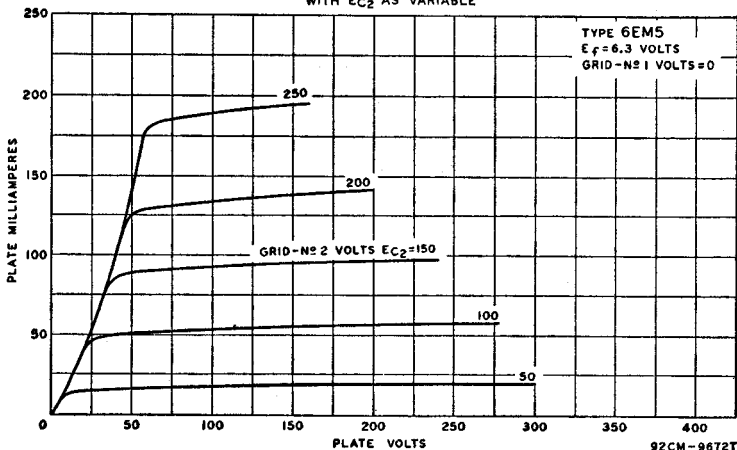

92CM-9672T

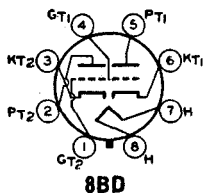

### DUAL TRIODE

Glass octal type containing high-mu triode and high-perveance, low-mu triode in same envelope. Used as combined vertical-deflection amplifier and vertical-deflection oscillator in television receivers employing picture tubes

## 6EM7

Related types:  
10EM7, 13EM7

having 110-degree deflection angles and high ultor voltages. Outline 13A, Outlines section. Tube requires octal socket and may be mounted in any position. For curve of average plate characteristics, Unit No.1, refer to type 6DR7 (Unit No.1). Types 10EM7 and 13EM7 are identical with type 6EM7 except for the heater ratings, as shown below.

	6EM7	10EM7	13EM7	
Heater Voltage (ac/dc)	6.3	9.7	13	volts
Heater Current	0.925	0.6	0.45	ampere
Heater Warm-up Time (Average)	—	11	11	seconds
Peak Heater-Cathode Voltage:				
Heater negative with respect to cathode	200 max	200 max	200 max	volts
Heater positive with respect to cathode	200*max	200*max	200*max	volts
Direct Interelectrode Capacitances (Approx.):		Unit No.1	Unit No.2	
Grid to Plate		4.8	10	pF
Grid to Cathode and Heater		2.2	7	pF
Plate to Cathode and Heater		0.6	1.8	pF

\* The dc component must not exceed 100 volts.

### Class A<sub>1</sub> Amplifier

CHARACTERISTICS:	Unit No.1	Unit No.2	
Plate Voltage	250	150	volts
Grid Voltage	-3	-20	volts
Amplification Factor	64	5.4	
Plate Resistance (Approx.)	40000	750	ohms
Transconductance	1600	7200	μmhos
Grid Voltage (Approx.):			
For plate current of 10 μA	-5.5	—	volts
For plate current of 100 μA	—	-45	volts
Plate Current	1.4	50	mA
Plate Current, for plate voltage of 60 volts and zero grid voltage	—	10	mA
Plate Current, for grid voltage of -28 volts	—	95	mA

### Vertical-Deflection Oscillator and Amplifier

For operation in a 525-line, 30-frame system

MAXIMUM RATINGS (Design-Maximum Values):	Unit No.1 Oscillator	Unit No.2 Amplifier	
DC Plate Voltage	330 max	330 max	volts
Peak Positive-Pulse Plate Voltage#	—	1500 max	volts
Peak Negative-Pulse Grid Voltage	-400 max	-250 max	volts
Peak Cathode Current	77 max	175 max	mA
Average Cathode Current	22 max	50 max	mA
Plate Dissipation	1.5 max	10 max	watts

# The duration of the voltage pulse must not exceed 15 per cent of one vertical-scanning cycle. In a 525-line, 30-frame system, 15 per cent of one vertical-scanning cycle is 2.5 milliseconds.

### MAXIMUM CIRCUIT VALUES:

Grid-Circuit Resistance:	Unit No.1	Unit No.2
For grid-resistor-bias operation	2.2 max	2.2 max megohms
For cathode-bias operation	2.2 max	2.2 max megohms

AVERAGE PLATE CHARACTERISTICS  
UNIT # 2

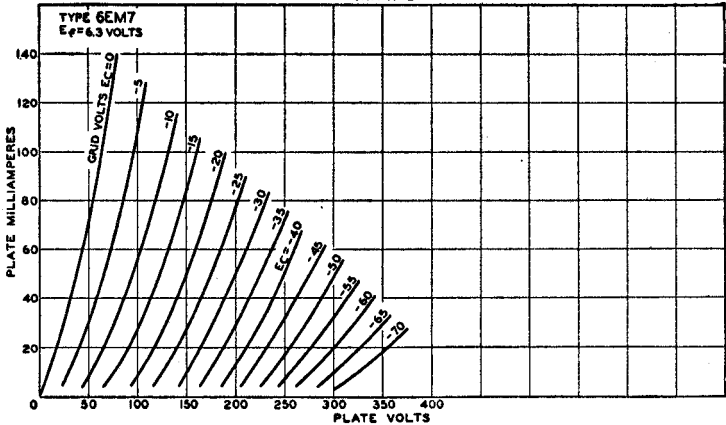

**DIODE—  
REMOTE-CUTOFF PENTODE**

**6EQ7**

Related type:  
12EQ7

Miniature type used as combined if amplifier and AM detector in AM and AM/FM radio receivers. Outline 6E, Outlines section. Tube requires miniature nine-contact socket and may be operated in any position. Type

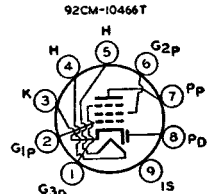

**9LQ**

12EQ7 is identical with type 6EQ7 except for the heater ratings, as shown below.

	6EQ7	12EQ7	
Heater Voltage (ac/dc) .....	6.3	12.6	volts
Heater Current .....	0.3	0.15	ampere
Peak Heater-Cathode Voltage:			
Heater negative with respect to cathode .....	200 max	200 max	volts
Heater positive with respect to cathode .....	200*max	200*max	volts
* The dc component must not exceed 100 volts.			
Direct Interelectrode Capacitances:			
Pentode Unit:			
Grid No.1 to Plate .....		0.002 max	pF
Grid No.1 to Cathode, Heater, Grid No.2, Grid No.3, and Internal Shield .....		5.5	pF
Plate to Cathode, Heater, Grid No.2, Grid No.3, and Internal Shield .....		5	pF
Pentode Grid No.1 to Diode Plate .....		0.0015 max	pF
Pentode Plate to Diode Plate .....		0.095	pF

**Pentode Unit as Class A<sub>1</sub> Amplifier**

MAXIMUM RATINGS (Design-Maximum Values):		
Plate Voltage .....	300 max	volts
Grid-No.3 (Suppressor-Grid) Voltage:		
Positive value .....	300 max	volts
Negative value .....	-300 max	volts
Grid-No.2 (Screen-Grid) Supply Voltage .....	300 max	volts
Grid-No.2 Voltage .....	See curve	page 80
Grid-No.1 (Control-Grid) Voltage:		
Positive-bias value .....	0 max	volts
Negative-bias value .....	-50 max	volts
Plate Dissipation .....	3 max	watts
Grid-No.3 Input .....	0.2 max	watt
Grid-No.2 Input:		
For grid-No.2 voltages up to 150 volts .....	0.6 max	watt
For grid-No.2 voltages between 150 and 300 volts .....	See curve	page 80
Bulb Temperature (At hottest point) .....	150 max	°C

**CHARACTERISTICS:**

Plate Voltage .....	100	volts
Grid No.3 .....	Connected to cathode	at socket
Internal Shield .....	Connected to cathode	at socket
Grid-No.2 Voltage .....	100	volts
Grid-No.1 Supply Voltage .....	0	volts
Grid-No.1 Resistor (Bypassed) .....	2.2	megohms
Plate Resistance (Approx.) .....	0.25	megohm
Transconductance .....	3800	$\mu$ mhos
Plate Current .....	9	mA
Grid-No.2 Current .....	3.5	mA
Grid-No.1 Voltage (Approx.) for transconductance of 40 $\mu$ mhos .....	-20	volts

**Diode Unit**

**MAXIMUM RATINGS (Design-Maximum Values):**

Plate Current .....	1 max	mA
<b>CHARACTERISTICS, Instantaneous Value:</b>		
Tube Voltage Drop for plate current of 2 mA .....	10	volts

AVERAGE CHARACTERISTICS

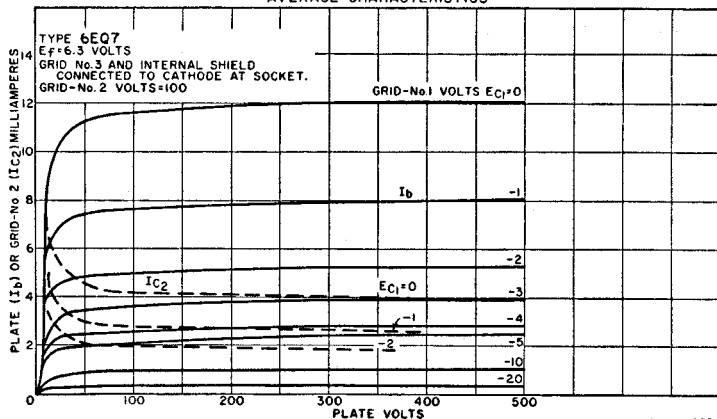

92CM-1069071

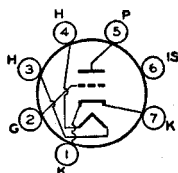

7FP

**HIGH-MU TRIODE**

Miniature type with frame grid used in vhf tuners of television receivers. Outline 5C, Outlines section. Tube requires miniature seven-contact socket and may be mounted in any position. Types 2ER5 and 3ER5 are identical

**6ER5**

Related types:  
2ER5, 3ER5

with type 6ER5 except for the heater ratings, as shown below.

Heater Voltage (ac/dc) .....	2.3	2.8	6.3	volts
Heater Current .....	0.6	0.45	0.18	ampere
<b>Peak Heater-Cathode Voltage:</b>				
Heater negative with respect to cathode ...	100 max	100 max	100 max	volts
Heater positive with respect to cathode ...	100 max	100 max	100 max	volts
		Without External Shield	With External Shield*	
<b>Direct Interelectrode Capacitances:</b>				
Grid to Plate .....		0.38	0.36	pF
Grid to Cathode, Heater, and Internal Shield .....		4.4	4.4	pF
Plate to Cathode, Heater, and Internal Shield .....		3	4	pF
Grid to Heater .....		0.28 max	0.28 max	pF
Plate to Cathode .....		0.24	0.2 $\Delta$	pF
Cathode to Grid .....		3.1	3.1 $\Delta$	pF
Heater to Cathode .....		2.5	2.5 $\Delta$	pF

\* With external shield connected to cathode except as noted.

$\Delta$  With external shield connected to ground.

**Class A<sub>1</sub> Amplifier**

**MAXIMUM RATINGS (Design-Center Values):**

Plate Voltage .....	250 max	volts
Grid Voltage, Negative-bias value .....	-50 max	volts
Cathode Current .....	20 max	mA
Plate Dissipation .....	2.2 max	watts

**CHARACTERISTICS:**

Plate Voltage .....	200	volts
Grid Voltage .....	-1.2	volts
Amplification Factor .....	80	
Plate Resistance (Approx.) .....	8000	ohms
Transconductance .....	10500	μmhos
Plate Current .....	10	mA
Grid Voltage (Approx.) for transconductance of 500 μmhos .....	-3.8	volts
Grid Voltage (Approx.) for transconductance of 100 μmhos .....	-5.6	volts

**MAXIMUM CIRCUIT VALUES:**

Grid Circuit Resistance .....	1 max	megohm
-------------------------------	-------	--------

**HIGH-MU TRIODE**

Miniature type used as grounded-cathode rf amplifier in vhf television receivers. Outline 5C, **Outlines** section. Tube requires miniature seven-contact socket and may be operated in any position.

**6ES5**

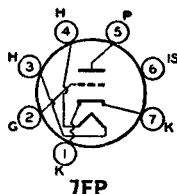

Heater Voltage (ac/dc) .....	6.3	volts
Heater Current .....	0.2	ampere
Peak Heater-Cathode Voltage:		
Heater negative with respect to cathode .....	100 max	volts
Heater positive with respect to cathode .....	100 max	volts

**Direct Interelectrode Capacitances:**

	Without External Shield	With External Shield	
Grid to Plate .....	0.5 max	0.5 max	pF
Grid to Cathode, Heater, and Internal Shield .....	3.2	3.2	pF
Plate to Cathode, Heater, and Internal Shield .....	3.2	4	pF

**Class A<sub>1</sub> Amplifier**

**MAXIMUM RATINGS (Design-Maximum Values):**

Plate Voltage .....	250 max	volts
Grid Voltage, Positive-bias value .....	0 max	volts
Cathode Current .....	22 max	mA
Plate Dissipation .....	2.2 max	watts

**CHARACTERISTICS:**

Plate Voltage .....	200	volts
Grid Voltage .....	-1	volt
Amplification Factor .....	75	
Plate Resistance (Approx.) .....	8000	ohms
Transconductance .....	9000	μmhos
Plate Current .....	10	mA
Grid Voltage (Approx.) for plate current of 100 μA .....	-6	volts

**MAXIMUM CIRCUIT VALUES:**

Grid-Circuit Resistance .....	1 max	megohm
-------------------------------	-------	--------

**VARIABLE-MU TWIN TRIODE**

Miniature type with high transconductance, variable mu, and low noise; used as cascode-type amplifier in tuners of television receivers. Outline 6B, **Outlines** section. Tube requires miniature nine-contact socket and

**6ES8**

Related type:  
4ES8

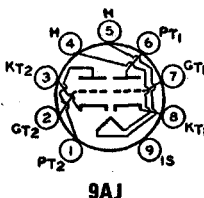

**9AJ**

may be operated in any position. Type 4ES8 is identical with type 6ES8 except for the heater ratings, as shown below.



Heater Voltage (ac/dc) .....	4ES8	6ES8	
Heater Current .....	4	6.3	volts
Heater Warm-up Time (Average) .....	0.6	0.365	ampere seconds
	11	—	
	Without External Shield	With External Shield*	
Direct Interelectrode Capacitances:			
Grid to Plate (Each Unit) .....	1.9	1.9	pF
Plate to Cathode (Each Unit) .....	0.18	0.17	pF
Heater to Cathode (Each Unit) .....	3	3 $\Delta$	pF
Plate of Unit No.2 to Plate of Unit No.1 .....	0.04 max	0.015 max	pF
Plate of Unit No.2 to Grid of Unit No.1 .....	0.003 max	0.003 max	pF
Grid of Unit No.1 to Cathode of Unit No.2 .....	0.002 max	0.002 max	pF

\* With external shield connected to cathode of unit under test except as noted.

$\Delta$  With external shield connected to ground.

**Class A<sub>1</sub> Amplifier (Each Unit)**

<b>CHARACTERISTICS:</b>			
Plate Voltage .....	90	90	90 volts
Grid Voltage .....	-1.2	-5	volts
Plate Resistance (Approx.) .....	2500	—	ohms
Transconductance .....	12500	625	125 $\mu$ mhos
Plate Current .....	15	—	mA

**Cascode-Type Amplifier**

**MAXIMUM RATINGS (Design-Center Values):**

Plate Supply Voltage with plate current of 0 mA .....	550 max	volts
Plate Voltage (Each unit) .....	130 max	volts
Grid Voltage, Negative-bias value (Each unit) .....	-50 max	volts
Cathode Current (Each unit) .....	22 max	mA
Plate Dissipation (Each unit) .....	1.8	watts

Heater-Cathode Voltage:

Unit No.1:*		
RMS voltage between cathode and heater .....	50 max	volts
Unit No.2:*		
RMS voltage between cathode and heater* .....	50 max	volts
DC voltage between cathode and heater* .....	130 max	volts

**TYPICAL OPERATION:** In a cascode-type circuit with the grid of the output unit connected to a voltage divider $\square$

Supply Voltage .....	180	volts
Plate Current .....	15	mA
Transconductance .....	12500	$\mu$ mhos
Noise Figure* .....	6.5	dB
Grid Voltage (Approx.) for transconductance of 125 $\mu$ mhos .....	-9	volts
Input Voltage for cross-modulation factor of 0.01 and transconductance of 125 $\mu$ mhos .....	500	mV

**MAXIMUM CIRCUIT VALUES:**

Grid-Circuit Resistance (Each unit) .....	1 max	megohm
---	-------	--------

\* Grounded-cathode input unit—pins 6, 7, and 8.

\* Grounded-grid output unit—pins 1, 2, and 3.

\* Cathode positive with respect to heater.

$\square$  In order not to exceed the maximum-rated plate voltage when the cascode-type amplifier is controlled it is necessary to use a voltage divider for the grid of the grounded-grid output unit.

\* Measured with tube operating in a television tuner.

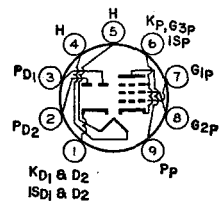

9LT

**TWIN DIODE—  
SHARP-CUTOFF PENTODE**

Miniature type used in television receivers. The pentode unit is used as a video amplifier and the diodes are used as a horizontal phase inverter. Outline 6E, **Outlines** section. Tube requires miniature nine-contact socket

**6ET7**

Related type:  
8ET7

and may be operated in any position. Type 8ET7 is identical with type 6ET7 except for the heater ratings, as shown below.

Heater Voltage (ac/dc) .....	6ET7	8ET7	
Heater Current .....	6.3	8	volts
Heater Warm-up Time (Average) .....	0.75	0.6	ampere seconds
	—	11	seconds

## Peak Heater-Cathode Voltage:

Heater negative with respect to cathode .....	200	200	volts
Heater positive with respect to cathode .....	200*	200*	volts

\* The dc component must not exceed 100 volts.

Pentode Unit as Class A<sub>1</sub> Amplifier

## MAXIMUM RATINGS (Design-Maximum Values):

Plate Voltage .....		330 max	volts
Grid-No.2 (Screen-Grid) Supply Voltage .....		330 max	volts
Grid-No.2 Voltage .....		See curve page 80	
Grid-No.1 (Control-Grid) Voltage, Positive-bias value .....		0 max	volts
Grid-No.2 Input:			
For grid-No. 2 voltages up to 165 volts .....		1.1 max	watts
For grid-No.2 voltages between 165 and 330 volts .....		See curve page 80	
Plate Dissipation .....		5 max	watts

## CHARACTERISTICS:

Plate Supply Voltage .....	60	200	volts
Grid-No.2 Supply Voltage .....	150	150	volts
Grid-No.1 Voltage .....	0	—	volts
Cathode-Bias Resistor .....	—	100	ohms
Plate Resistance (Approx.) .....	—	60000	ohms
Transconductance .....	—	11500	$\mu$ mhos
Plate Current .....	55*	25	mA
Grid-No.2 Current .....	18*	5.5	mA
Grid-No.1 Voltage (Approx.) for plate current of 100 $\mu$ A .....	—	—10	volts

## MAXIMUM CIRCUIT VALUES:

Grid-No.1-Circuit Resistance:			
For fixed-bias operation .....		0.1 max	megohm
For cathode-bias operation .....		0.25 max	megohm

\* This value can be measured by a method involving a recurrent waveform such that the maximum ratings of the tube will not be exceeded.

## Diode Units (Each Unit)

## MAXIMUM RATINGS (Design-Maximum Values):

DC Plate Current .....		3 max	mA
Tube Voltage Drop for plate current of 1.5 mA .....		10	volts

## HIGH-MU TWIN TRIODE

6EU7

Miniature type used in high-gain, resistance-coupled, low-level audio-amplifier applications where low-hum and non-microphonic characteristics are important considerations, such as in microphone amplifiers and in pre-

amplifiers for mono- and stereophonic phonographs. Outline 6B, Outlines section. Tube requires miniature nine-contact socket and may be mounted in any position. For typical operation as a resistance-coupled amplifier, refer to **Resistance-Coupled Amplifier** section.

Heater Voltage (ac/dc) .....		6.3	volts
Heater Current .....		0.3	ampere
Peak Heater-Cathode Voltage:			
Heater negative with respect to cathode .....		200 max	volts
Heater positive with respect to cathode .....		200* max	volts
Direct Interelectrode Capacitances (Each Unit, Approx.):			
Grid to Plate .....		1.5	pF
Grid to Cathode and Heater .....		1.6	pF
Plate to Cathode and Heater .....		0.2	pF
Equivalent Noise and Hum Voltage (Referenced to Grid, Each Unit):			
Average Value* .....		1.8	microvolts rms

\* The dc component must not exceed 100 volts.

\* Measured in "true rms" units under the following conditions: Heater volts (ac), 6.3; center-tap of heater transformer grounded; plate supply volts, 250; plate load resistor, 100000 ohms; cathode resistor, 2700 ohms; cathode bypass capacitor, 100  $\mu$ F; grid resistor, 0 ohms; amplifier frequency range, 25 to 10000 c/s.

Class A<sub>1</sub> Amplifier (Each Unit)

## MAXIMUM RATINGS (Design-Maximum Values):

Plate Voltage .....		330 max	volts
---------------------	--	---------	-------

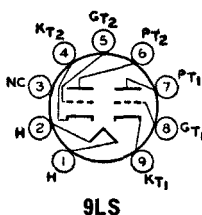

9LS

Grid Voltage:			
Negative-bias value .....		-55 max	volts
Positive-bias value .....		0 max	watts
Plate Dissipation .....		1.2 max	watts
<b>CHARACTERISTICS:</b>			
Plate Voltage .....	100	250	volts
Grid Voltage .....	-1	-2	volts
Amplification Factor .....	100	100	
Plate Resistance (Approx.) .....	80000	62500	ohms
Transconductance .....	1250	1600	amhos
Plate Current .....	0.5	1.2	mA

AVERAGE PLATE CHARACTERISTICS  
EACH UNIT

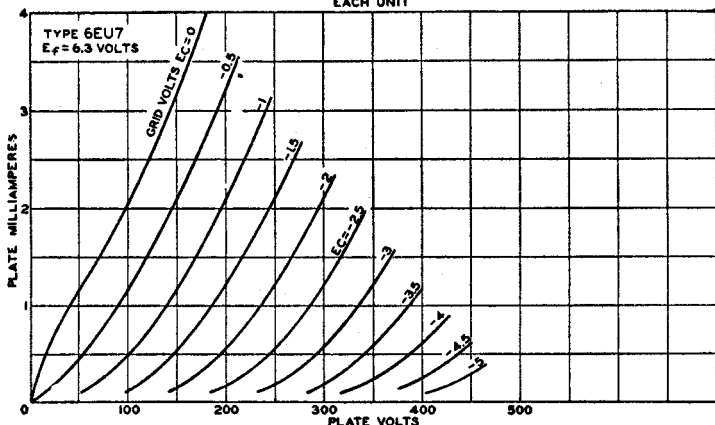

92CM-10470T

**MEDIUM-MU TRIODE—  
SHARP-CUTOFF PENTODE**

Miniature type used as combined triode oscillator and pentode mixer in television receivers. Outline 6B, Outlines section. Tube requires miniature nine-contact socket and may be operated in any position. Type 5EU8 is

**6EU8**

Related type:  
**5EU8**

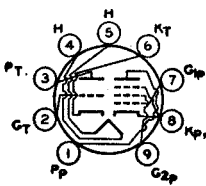

9JF

identical with type 6EU8 except for the heater ratings, as shown below.

Heater Voltage (ac/dc) .....	5EU8	6EU8	
Heater Current .....	4.7	6.3	volts
Heater Warm-up Time (Average) .....	0.6	0.45	ampere
Peak Heater-Cathode Voltage:			seconds
Heater negative with respect to cathode .....	200 max	200 max	volts
Heater positive with respect to cathode .....	200*max	200*max	volts

\* The dc component must not exceed 100 volts.

**MAXIMUM RATINGS (Design-Center Values):**

Plate Voltage .....	Triode Unit	Pentode Unit	
Grid-No.2 (Screen-Grid) Supply Voltage .....	330 max	330 max	volts
Grid-No.2 Voltage .....	—	330 max	volts
Grid-No.1 (Control-Grid) Voltage, Positive-bias value ..	0 max	See curve page 80	
Plate Dissipation .....	3 max	0 max	volts
Grid-No.2 Input:		3.1 max	watts
For grid-No.2 voltages up to 165 volts .....	—	0.55 max	watt
For grid-No.2 voltages between 165 and 330 volts .....		See curve page 80	

**CHARACTERISTICS:**

Plate Supply Voltage .....	150	125	volts
Grid-No.2 Supply Voltage .....	—	125	volts
Grid-No.1 Voltage .....	—	-1	volt
Cathode-Bias Resistor .....	56	—	ohms

Amplification Factor .....	40	—	
Plate Resistance (Approx.) .....	5000	80000	ohms
Transconductance .....	8500	6400	$\mu$ mhos
Grid-No.1 Voltage (Approx.) for plate current of 10 $\mu$ A .....	-12	-9	volts
Plate Current .....	18	12	mA
Grid-No.2 Current .....	—	4	mA
Cathode Warm-up Time* .....	35	—	seconds

**MAXIMUM CIRCUIT VALUES:**

Grid-No.1-Circuit Resistance .....	0.1 max	0.1 max	megohm
------------------------------------	---------	---------	--------

\* The cathode warm-up time is defined as the time required for the transconductance to reach 6500  $\mu$ mhos when the tube is operated from a cold start with dc plate volts = 100, grid volts = 0, and heater volts = 5.5.

**SHARP-CUTOFF TETRODE****6EV5**

Miniature type used as rf amplifier in vhf tuners of television receivers. Outline 5C, **Outlines** section. Tube requires miniature seven-contact socket and may be operated in any position.

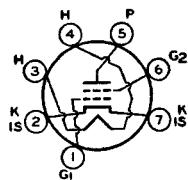
**7EW**

Heater Voltage (ac/dc) .....	6.3	volts
Heater Current .....	0.2	ampere
Peak Heater-Cathode Voltage:		
Heater negative with respect to cathode .....	100 max	volts
Heater positive with respect to cathode .....	100* max	volts
Direct Interelectrode Capacitances: <sup>Δ</sup>		
Grid No.1 to Plate .....	0.035 max	pF
Grid No.1 to Cathode, Heater, Grid No.2, and Internal Shield ..	4.5	pF
Plate to Cathode, Heater, Grid No.2, and Internal Shield .....	2.9	pF

\* The dc component must not exceed 50 volts.

<sup>Δ</sup> With external shield connected to cathode.

**Class A<sub>1</sub> Amplifier****MAXIMUM RATINGS (Design-Maximum Values):**

Plate Voltage .....	275 max	volts
Grid-No.2 (Screen-Grid) Supply Voltage .....	180 max	volts
Grid-No.2 Voltage .....	See curve page 80	
Grid-No.1 (Control-Grid) Voltage, Positive-bias value .....	0 max	volts
Cathode Current .....	20 max	mA
Grid-No.2 Input:		
For grid-No.2 voltages up to 90 volts .....	0.2 max	watt
For grid-No.2 voltages between 90 and 180 volts .....	See curve page 80	
Plate Dissipation .....	3.25 max	watts

**CHARACTERISTICS:**

Plate Voltage .....	250	volts
Grid-No.2 Voltage .....	80	volts
Grid-No.1 Voltage .....	-1	megohm
Plate Resistance (Approx.) .....	0.15	megohm
Transconductance .....	8800	$\mu$ mhos
Plate Current .....	11.5	mA
Grid-No.2 Current .....	0.9	mA
Grid-No.1 Voltage (Approx.) for transconductance of 100 $\mu$ mhos .....	-4.5	volts

**MAXIMUM CIRCUIT VALUE:**

Grid-No.1-Circuit Resistance .....	0.5 max	megohm
------------------------------------	---------	--------

**SHARP-CUTOFF PENTODE****6EW6**

Related types:  
4EW6, 5EW6

Miniature type used in the gain-controlled picture-if stages of vhf television receivers operating at an intermediate frequency in the order of 40 megacycles per second. This tube features controlled plate-current cutoff

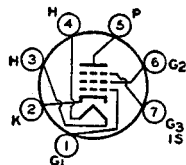
**7CM**

and high transconductance (1400  $\mu$ mhos) combined with low interelectrode

capacitance values. Tube is provided with separate base pins for grid No.3 and cathode to permit the use of an unbypassed cathode resistor to minimize changes in input conductance and input capacitance with bias, without causing oscillation. Outline 5C, **Outlines** section. Tube requires miniature seven-contact socket and may be mounted in any position. Types 4EW6 and 5EW6 are identical with type 6EW6 except for the heater ratings, as shown below.

	4EW6	5EW6	6EW6	
Heater Voltage (ac/dc)	4.2	5.6	6.3	volts
Heater Current	0.6	0.45	0.4	ampere
Heater Warm-up Time (Average)	11	11	—	seconds

**Peak Heater-Cathode Voltage:**

Heater negative with respect to cathode	200 max	200 max	200 max	volts
Heater positive with respect to cathode	200*max	200*max	200*max	volts

**Direct Interelectrode Capacitances:**

	Without External Shield	With External Shield*	
Grid No.1 to Plate			pF
Grid No.1 to Cathode, Heater, Grid No.2, Grid No.3 and Internal Shield	0.04 max	0.03 max	pF
Plate to Cathode, Heater, Grid No.2, Grid No.3, and Internal Shield	10	10	pF
	2.4	3.4	pF

\* The dc component must not exceed 100 volts.

\* With external shield connected to cathode.

**Class A<sub>1</sub> Amplifier**

**MAXIMUM RATINGS (Design-Maximum Values):**

Plate Voltage	330 max	volts
Grid No.3 (Suppressor-Grid) Voltage, Positive value	0 max	volts
Grid-No.2 (Screen-Grid) Supply Voltage	330 max	volts
Grid-No.2 Voltage	See curve page 80	
Grid-No.1 (Control-Grid) Voltage, Positive-bias value	0 max	volts
Plate Dissipation	3.1 max	watts
Grid-No.2 Input:		
For grid-No.2 voltages up to 165 volts	0.65 max	watt
For grid-No.2 voltages between 165 and 330 volts	See curve page 80	

**CHARACTERISTICS:**

Plate Supply Voltage	125	volts
Grid No.3	Connected to cathode at socket	
Grid-No.2 Supply Voltage	125	volts
Cathode-Bias Resistor	56	ohms
Plate Resistance (Approx.)	0.2	megohm
Transconductance	14000	$\mu$ mhos
Grid-No.1 Voltage (Approx.) for plate current of 20 $\mu$ A	-3.5	volts
Plate Current	11	mA
Grid-No.2 Current	3.2	mA

**AVERAGE CHARACTERISTICS**

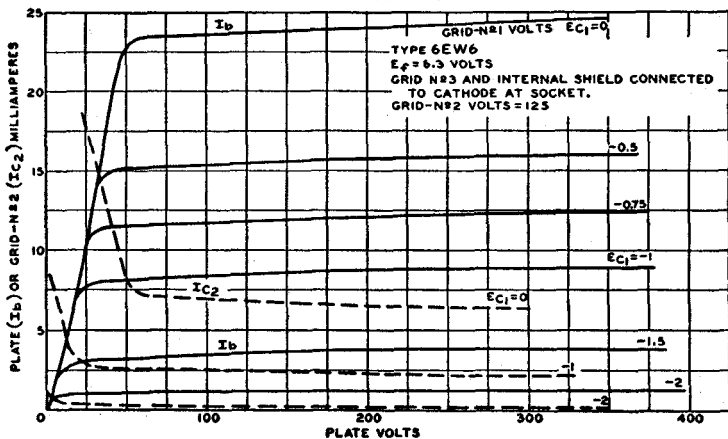

**DUAL TRIODE**

**6EW7**

Neonovall type used as combined vertical-deflection oscillator and vertical-deflection amplifier in television receivers. Outline 10C, Outlines section. Tube requires neonovall nine-contact socket and may be operated in any

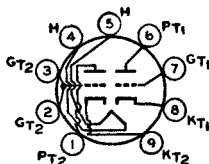

**9HF**

position. For curve of average plate characteristics, Unit No.1, refer to type 6DE7 (Unit No.1).

Heater Voltage (ac/dc)	6.3	volts	
Heater Current	0.9	ampere	
Peak Heater-Cathode Voltage:			
Heater negative with respect to cathode	200 max	volts	
Heater positive with respect to cathode	200*max	volts	
Direct Interelectrode Capacitances (Approx.):	Unit No.1	Unit No.2	
Grid to Plate	4.2	9	pF
Grid to Cathode and Heater	2.2	7	pF
Plate to Cathode and Heater	0.4	1.2	pF

\* The dc component must not exceed 100 volts.

**Class A<sub>1</sub> Amplifier**

<b>CHARACTERISTICS:</b>	Unit No.1	Unit No.2	
Plate Voltage	250	150	volts
Grid Voltage	-11	-17.5	volts
Amplification Factor	17.5	6	
Plate Resistance (Approx.)	8750	800	ohms
Transconductance	2000	7500	μmhos
Grid Voltage (Approx.) for plate current of 10 μA	-20	-	volts
Grid Voltage (Approx.) for plate current of 100 μA	-	-40	volts
Plate Current	5.5	45	mA
Plate Current for plate voltage of 60 volts and zero grid voltage	-	95	mA
Plate Current for grid voltage of -25 volts	-	8	mA

**Vertical-Deflection Oscillator and Amplifier**

For operation in a 525-line, 30-frame system

<b>MAXIMUM RATINGS (Design-Maximum Values):</b>	Unit No.1	Unit No.2	
DC Plate Voltage	Oscillator	Amplifier	
Peak Positive-Pulse Plate Voltage*	330 max	330 max	volts
	-	1500 max	volts

**AVERAGE CHARACTERISTICS**

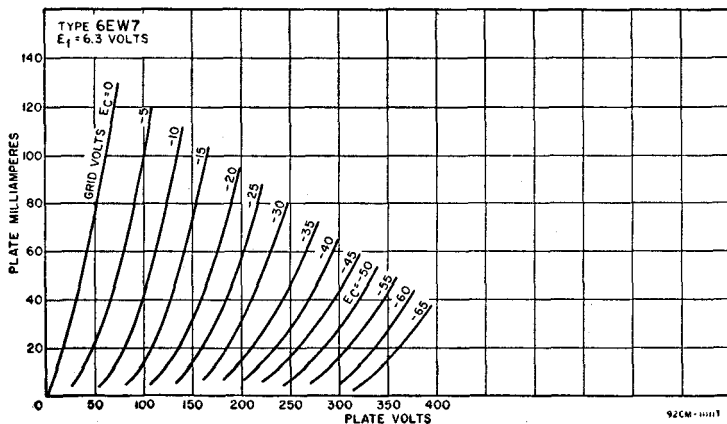

	Unit No.1	Unit No.2	
Peak Negative-Pulse Grid Voltage .....	Oscillator -400 max	Amplifier -250 max	volts
Peak Cathode Current .....	77 max	175 max	mA
Average Cathode Current .....	22 max	50 max	mA
Plate Dissipation .....	1.5 watt	10 max	watts

**MAXIMUM CIRCUIT VALUES:**

Grid-Circuit Resistance:		
For cathode-bias operation .....	2.2 max	2.2 max megohms
For grid-resistor-bias operation .....	2.2 max	2.2 max megohms

• The duration of the voltage pulse must not exceed 15 per cent of one vertical scanning cycle. In a 525-line, 30-frame system, 15 per cent of one vertical scanning cycle is 2.5 milliseconds.

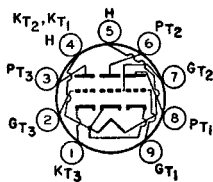

**HIGH-MU TRIPLE TRIODE**

Miniature type used in oscillator-mixer and afc service in FM receivers. Outline 6B, **Outlines** section. Tube requires miniature nine-contact socket and may be operated in any position. Heater volts (ac/dc), 6.3; amperes,

**6EZ8**

0.45; peak heater-cathode volts, 100.

**Class A<sub>1</sub> Amplifier (Each Unit Unless Otherwise Specified)**

<b>MAXIMUM RATINGS (Design-Maximum Values):</b>		
Plate Voltage .....	330 max	volts
Grid Voltage:		
Negative-bias value .....	-50 max	volts
Positive-bias value .....	0 max	volts
Plate Dissipation .....	2 max	watts
Total Plate Dissipation (All plates) .....	5 max	watts

**CHARACTERISTICS:**

Plate Voltage .....	125	volts
Grid Voltage .....	1	volt
Amplification Factor .....	57	
Plate Resistance (Approx.) .....	13600	ohms
Transconductance .....	4200	μmhos
Grid Voltage (Approx.) for plate current of 20 μA .....	-4	volts
Plate Current .....	4.2	mA

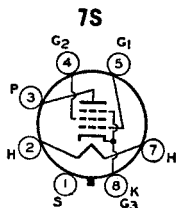

**POWER PENTODE**

Metal type used in the audio output stage of ac receivers. This tube is capable of large power output with relatively small input voltage. Outline 2B, **Outlines** section. Tube requires octal socket and may be

**6F6**

mounted in any position. It is especially important that this tube, like other power-handling tubes, be adequately ventilated. Heater volts (ac/dc), 6.3; amperes, 0.7; peak heater-cathode volts, 90.

**Class A<sub>1</sub> Amplifier**

<b>MAXIMUM RATINGS (Design-Maximum Values):</b>		Pentode Connection	Triode Connection <sup>▲</sup>	
Plate Voltage .....		375 max	350 max	volts
Grid-No.2 (Screen-Grid) Voltage .....		285 max	—	volts
Plate Dissipation .....		11 max	10 max	watts
Grid-No.2 Input .....		3.75 max	—	watts
<b>TYPICAL OPERATION:</b>				
Plate Voltage .....	250	285	250	volts
Grid-No.2 Voltage .....	250	285	—	volts
Grid-No.1 (Control-Grid) Voltage .....	-16.5	-20	-20	volts

	Pentode Connection		Triode Connection <sup>▲</sup>	
Peak AF Grid-No.1 Voltage .....	16.5	20	20	volts
Zero-Signal Plate Current .....	34	38	31	mA
Maximum-Signal Plate Current .....	36	40	34	mA
Zero-Signal Grid-No.2 Current .....	6.5	7	—	mA
Maximum-Signal Grid-No.2 Current .....	10.5	13	—	mA
Amplification Factor .....	—	—	6.8	
Plate Resistance (Approx.) .....	80000	78000	2600	ohms
Transconductance .....	2500	2550	2600	μmhos
Load Resistance .....	7000	7000	4000	ohms
Total Harmonic Distortion .....	8	9	6.5	per cent
Maximum-Signal Power Output .....	3.2	4.8	0.85	watts

▲ Grid No.2 connected to plate.

### Push-Pull Class A<sub>1</sub> Amplifier

**MAXIMUM RATINGS:** (Same as for class A<sub>1</sub> amplifier)

**TYPICAL OPERATION** (Values are for two tubes):

Plate Voltage .....	315	volts
Peak AF Grid-No.1-to-Grid-No.1 Voltage .....	285	volts
Zero-Signal Plate Current .....	—24	volts
Peak AF Grid-No.1-to-Grid-No.1 Voltage .....	48	volts
Zero-Signal Plate Current .....	62	mA
Maximum-Signal Plate Current .....	80	mA
Zero-Signal Grid-No.2 Current .....	12	mA
Maximum-Signal Grid-No.2 Current .....	19.5	mA
Effective Load Resistance (Plate-to-plate) .....	10000	ohms
Total Harmonic Distortion .....	4	per cent
Maximum-Signal Power Output .....	11	watts

**MAXIMUM CIRCUIT VALUES:**

Grid-No.1 Circuit Resistance:

For fixed-bias operation .....	0.1 max	megohm
For cathode-bias operation .....	0.5 max	megohm

### DIODE—SHARP-CUTOFF, TWIN-PLATE TETRODE

## 6FA7

Miniature type used in frequency-divider and complex-wave generator circuits of electronic musical instruments. Outline 6E, **Outlines** section. Tube requires miniature nine-contact socket and may be operated in any position.

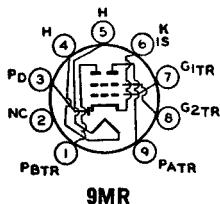

**9MR**

Heater Voltage (ac/dc) .....	6.3	volts
Heater Current .....	0.3	ampere
Peak Heater-Cathode Voltage:		
Heater negative with respect to cathode .....	200 max	volts
Heater positive with respect to cathode .....	200*max	volts
Direct Interelectrode Capacitances:		
Tetrode Unit:		
Grid No.1 to Plate A .....	0.040	pF
Grid No.1 to Plate B .....	0.030 max	pF
Grid No.1 to Cathode, Heater, Grid No.2, and Internal Shield ..	5.5	pF
Plate A to Cathode, Heater, Grid No.2, and Internal Shield ..	1.8	pF
Plate B to Cathode, Heater, Grid No.2, and Internal Shield ..	1.8	pF
Tetrode Grid No.1 to Diode Plate .....	0.022	pF
Tetrode Plate A to Diode Plate .....	0.020 max	pF
Tetrode Plate B to Diode Plate .....	0.055	pF

\* The dc component must not exceed 100 volts.



Class A<sub>1</sub> Amplifier

CHARACTERISTICS (Tetrode Unit):

Plate A and Plate B connected together

Plate Voltage	100	volts
Grid-No.2 Voltage	100	volts
Grid-No.1 Supply Voltage	0	volts
Grid-No.1 Resistor (Bypassed)	2.2	megohms
Plate Resistance (Approx.)	90000	ohms
Transconductance	3200	μmhos
Plate Current	3.8	mA
Grid-No.2 Current	1.7	mA
Grid-No.1 Voltage (Approx.) for plate current of 20 μA	-4	volts

Using either Plate A or B, with unused plate grounded

Plate Voltage	100	volts
Grid-No.2 Voltage	100	volts
Grid-No.1 Supply Voltage	0	volts
Grid-No.1 Resistor (Bypassed)	2.2	megohms
Plate Resistance (Approx.)	130000	ohms
Transconductance	1900	μmhos
Plate Current	2.2	mA
Grid-No.2 Current	3	mA

Frequency Divider & Complex-Wave Generator

Tetrode Unit

MAXIMUM RATINGS (Design-Maximum Values):

Plate-A Voltage	330 max	volts
Plate-B Voltage	330 max	volts
Grid-No.2 (Screen-Grid) Supply Voltage	330 max	volts
Grid-No.2 Voltage	See curve	page 80
Grid-No.1 (Control-Grid) Voltage:		
Negative-bias value	-50 max	volts
Positive-bias value	0 max	volts
Plate-A Dissipation	1.5 max	watts
Plate-B Dissipation	1.5 max	watts
Grid-No.2 Input:		
For grid-No.2 voltages up to 165 volts	0.65 max	watt
For grid-No.2 voltages between 165 and 330 volts	See curve	page 80

MAXIMUM CIRCUIT VALUES:

Grid-No.1 Circuit Resistance:

For grid-No.1 resistor-bias operation	2.2 max megohms
---------------------------------------	-----------------

AVERAGE CHARACTERISTICS

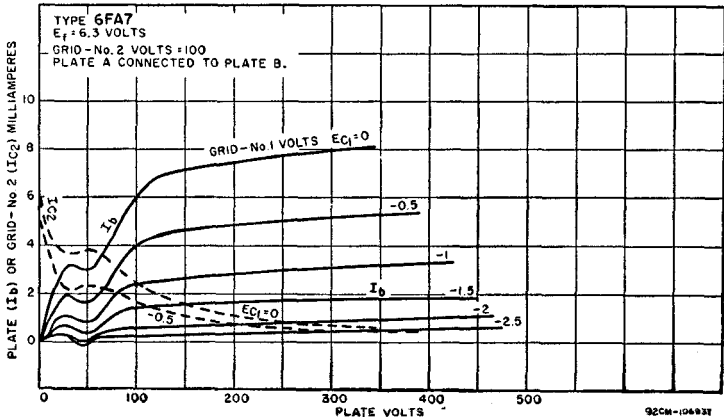

## Diode Unit

**MAXIMUM RATINGS (Design-Maximum Values):**

Plate Current .....	1 max	mA
---------------------	-------	----

**CHARACTERISTICS, Instantaneous Value:**

Tube Voltage Drop for plate current of 2 mA .....	10	volts
---	----	-------

**DUAL TRIODE****6FD7**

Related type:  
13FD7

Glass type containing high- $\mu$  and low- $\mu$  triode units used as combined vertical-deflection oscillator and vertical-deflection amplifier in television receivers. Outline 10B, **Outlines** section. Tube requires miniature nine-

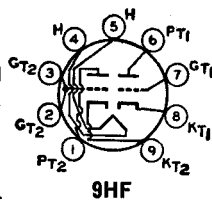

contact socket and may be mounted in any position. Type 13FD7 is identical with type 6FD7 except for the heater ratings, as shown below.

	6FD7	13FD7	
Heater Voltage (ac/dc) .....	6.3	13	volts
Heater Current .....	0.925	0.45	ampere
Heater Warm-up Time (Average) .....	—	11	seconds
Peak Heater-Cathode Voltage:			
Heater negative with respect to cathode .....	200 max	200 max	volts
Heater positive with respect to cathode .....	200*max	200*max	volts

\* The dc component must not exceed 100 volts.

**Class A<sub>1</sub> Amplifier****CHARACTERISTICS:**

	Unit No.1	Unit No.2	
Plate Voltage .....	250	60	150
Grid Voltage .....	-3	0	-17.5
Amplification Factor .....	64	—	6
Plate Resistance (Approx.) .....	40000	—	800
Transconductance .....	1600	—	7500
Plate Current .....	1.5	95 $\square$	40
Grid Voltage (Approx.):			
For plate current of 10 $\mu$ A .....	-5.5	—	—
For plate current of 100 $\mu$ A .....	—	—	-40
Transconductance, for plate current of 1 mA .....	—	—	500
Plate Current, for grid voltage of -25 volts .....	—	—	6

$\square$  This value can be measured by a method involving a current waveform such that the maximum ratings of the tube will not be exceeded.

**Vertical-Deflection Oscillator and Amplifier**

For operation in a 525-line, 30-frame system

	Unit No.1 Oscillator	Unit No.2 Amplifier	
<b>MAXIMUM RATINGS (Design-Maximum Values):</b>			
DC Plate Voltage .....	330 max	330 max	volts
Peak Positive-Pulse Plate Voltage* .....	—	1500 max	volts
Peak Negative-Pulse Grid Voltage .....	-400	-250 max	volts
Peak Cathode Current .....	70 max	175 max	mA
Average Cathode Current .....	20 max	50 max	mA
Plate Dissipation .....	1.5 max	10 max	watts

**MAXIMUM CIRCUIT VALUES:**

Grid-Circuit Resistance:		
For grid-resistor-bias or cathode-bias operation ..	2.2 max	2.2 max megohms

\* The duration of the voltage pulse must not exceed 15 per cent of one vertical scanning cycle. In a 525-line, 30-frame system, 15 per cent of one vertical scanning cycle is 2.5 milliseconds.

Refer to type EM84/6FG6.

**6FG6**

**MEDIUM-MU TRIODE—  
SHARP-CUTOFF PENTODE**

**6FG7**

Related type:  
**5FG7**

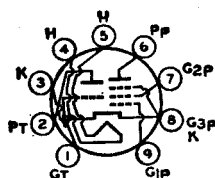

**9GF**

Miniature type used as combined oscillator and mixer tube in vhf television receivers employing series-connected heater strings. Outline 6B, Outlines section. Tube requires miniature nine-contact socket and may be mounted in any position. Type 5FG7 is identical with type 6FG7 except for the heater ratings, as shown below.

	<b>5FG7</b>	<b>6FG7</b>	
Heater Voltage (ac/dc) .....	4.7	6.3	volts
Heater Current .....	0.6	0.45	ampere
Heater Warm-up Time (Average) .....	11	11	seconds
<b>Peak Heater-Cathode Voltage:</b>			
Heater negative with respect to cathode .....	200 max	200 max	volts
Heater positive with respect to cathode .....	200*max	200*max	volts

\* The dc component must not exceed 100 volts.

**Class A<sub>1</sub> Amplifier**

**MAXIMUM RATINGS (Design-Maximum Values):**

	Triode Unit	Pentode Unit	
Plate Voltage .....	330 max	330 max	volts
Grid-No.2 (Screen-Grid) Supply Voltage .....	—	330 max	volts
Grid-No.2 Voltage .....	—	See curve page 80	
Grid-No.1 (Control-Grid) Voltage, Positive-bias value ..	0 max	0 max	volts
Grid-No.2 Input:			
For grid-No.2 voltages up to 165 volts .....	—	0.55 max	watt
For grid-No.2 voltages between 165 and 330 volts ..	—	See curve page 80	
Plate Dissipation .....	2.5 max	3 max	watts

**CHARACTERISTICS:**

Plate Voltage .....	125	100	125	volts
Grid-No.2 Voltage .....	—	100	125	volts
Grid-No.1 Voltage .....	—1	0	—1	volts
Amplification Factor .....	43	—	—	
Plate Resistance (Approx.) .....	5700	—	18000	ohms
Transconductance .....	7500	7400	6000	μmhos
Plate Current .....	13	—	11	mA
Grid-No.2 Current .....	—	—	4	mA
Grid-No.1 Voltage (Approx.) for plate current of 30 μA .....	—6.5	—	—7.5	volts

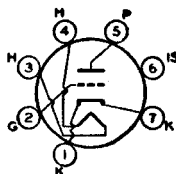

**7FP**

**HIGH-MU TRIODE**

Miniature type used as an rf amplifier in vhf tuners of television receivers. Outline 5C, Outlines section. Tube requires seven-contact socket and may be mounted in any position. Types 2FH5 and 3FH5 are identical with type 6FH5 except for the heater ratings, as shown below.

**6FH5**

Related types:  
**2FH5, 3FH5**

	<b>2FH5</b>	<b>3FH5</b>	<b>6FH5</b>	
Heater Voltage (ac/dc) .....	2.35	3	6.3	volts
Heater Current .....	0.6	0.45	0.2	ampere
Heater Warm-up Time (Average) .....	11	11	—	seconds
<b>Peak Heater-Cathode Voltage:</b>				
Heater negative with respect to cathode ..	100 max	100 max	100 max	volts
Heater positive with respect to cathode ..	100 max	100 max	100 max	volts

Direct Interelectrode Capacitances (Approx.):	Without External Shield	With External Shield*	
Grid to Plate .....	0.52	0.52	pF
Grid to Cathode, Heater, and Internal Shield .....	3.2	3.2	pF
Plate to Cathode, Heater, and Internal Shield .....	3.2	4	pF

**Class A<sub>1</sub> Amplifier**

**MAXIMUM RATINGS (Design-Maximum Values):**

Plate Voltage .....	150 max	volts
Grid Voltage, Positive-bias value .....	0 max	volts
Cathode Current .....	22 max	mA
Plate Dissipation .....	2.2 max	watts

**CHARACTERISTICS:**

Plate Voltage .....	135	volts
Grid Voltage .....	-1	volts
Plate Resistance (Approx.) .....	5600	ohms
Transconductance .....	9000	μmhos
Plate Current .....	11	mA
Grid Voltage (Approx.) for plate current of 100 μA .....	-5.5	volts

**MAXIMUM CIRCUIT VALUES:**

Grid-Circuit Resistance:	
For cathode-bias operation .....	1 max megohm

AVERAGE PLATE CHARACTERISTICS

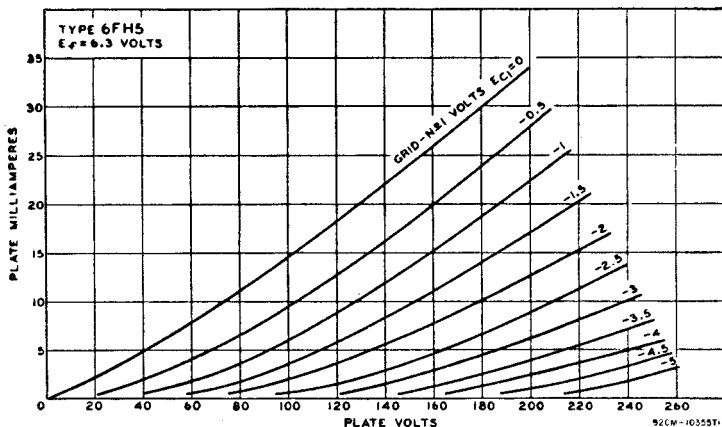

**MEDIUM-MU TRIODE—THREE-PLATE TETRODE**

**6FH8**

Miniature type used in complex-wave generator applications. Sharp-cutoff tetrode unit has pair of additional plates. Outline 6B, **Outlines** section. Tube requires nine-contact socket and may be mounted in any position.

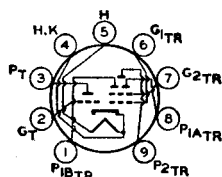

**9KP**

Heater Voltage (ac/dc) .....	6.3	volts
Heater Current .....	0.45	ampere
Direct Interelectrode Capacitances:*		
Triode Unit:		
Grid to Plate .....	1.4	pF
Grid to Cathode and Heater .....	2.6	pF
Plate to Cathode and Heater .....	1	pF

Tetrode Unit:		
Grid No.1 to Plate No.2 .....	0.06 max	pF
Grid No.1 to Cathode, Heater, Grid No.2, Plate No.1A, and Plate No.1B .....	4.5	pF
Plate No.2 to Cathode, Heater, Grid No.2, Plate No.1A, and Plate No.1B .....	1.4	pF
Tetrode Grid No.1 to Triode Plate .....	0.35 max	pF
Tetrode Plate No.2 to Triode Plate .....	0.008 max	pF

° With external shield connected to cathode.

**Class A<sub>1</sub> Amplifier**

<b>CHARACTERISTICS:</b>	<b>Triode Unit</b>	
Plate Voltage .....	100	volts
Grid Voltage .....	-1	volt
Amplification Factor .....	40	
Plate Resistance (Approx.) .....	7400	ohms
Transconductance .....	5400	μmhos
Plate Current .....	7.9	mA
Grid Voltage (Approx.) for plate current of 100 μA .....	-7	volts

**Tetrode Unit with Plates No.1A and No.1B Connected to Cathode at Socket**

Plate-No.2 Voltage .....	250	volts
Grid-No.2 Voltage .....	250	volts
Grid-No.1 Voltage .....	-2	volts
Plate-No.2 Resistance (Approx.) .....	0.75	megohm
Transconductance, Grid No.1 to Plate No.2 .....	4400	μmhos
Plate-No.2 Current .....	7.3	mA
Grid-No.2 Current .....	1.4	mA
Grid-No.1 Voltage (Approx.) for plate-No.2 current of 100 μA .....	-7	volts

**Complex-Wave Generator**

<b>MAXIMUM RATINGS (Design-Maximum Values):</b>	<b>Triode Unit</b>	<b>Tetrode Unit</b>	
Plate Voltage .....	275 max	—	volts
Plate-No.1A Voltage .....	—	200 max	volts
Plate-No.1B Voltage .....	—	200 max	volts
Plate-No.2 Voltage .....	—	275 max	volts
Grid-No.2 (Screen-Grid) Supply Voltage .....	—	275 max	volts
Grid-No.2 Voltage .....	—	See curve page 80	
Grid-No.1 (Control-Grid) Voltage:			
Negative-bias value .....	-40 max	-40 max	volts
Positive-bias value .....	0 max	0 max	volts
Plate Dissipation .....	1.7 max	—	watts
Plate-No.1A Dissipation .....	—	0.3 max	watt
Plate-No.1B Dissipation .....	—	0.3 max	watt
Plate-No.2 Dissipation .....	—	2.3 max	watts
Grid-No.2 Input:			
For grid-No.2 voltages up to 137.5 volts .....	—	0.45 max	watt
For grid-No.2 voltages between 137.5 and 275 volts .....	—	See curve page 80	

**TYPICAL OPERATION WITH SEPARATE PLATE OPERATION:**

	<b>Tetrode Unit</b>	
Plates-No.1A, No.1B, and No.2 Voltage .....	100	volts
Grid-No.2 Voltage .....	50	volts
Grid-No.1 Voltage .....	-1	volts
Plate-No.1A Current .....	0.04	mA
Plate-No.1B Current .....	0.04	mA
Plate-No.2 Current .....	1.6	mA
Grid-No.2 Current .....	0.3	mA
Transconductance (Approx.):		
Grid No.1 to Plate No.1A .....	70	μmhos
Grid No.1 to Plate No.1B .....	70	μmhos
Grid No.1 to Plate No.2 .....	2500	μmhos

**MAXIMUM CIRCUIT VALUES:**

Grid-No.1-Circuit Resistance:	<b>Triode Unit</b>	<b>Tetrode Unit</b>
For fixed-bias operation .....	0.5 max	0.5 max megohm

## 6FJ7

## MEDIUM-MU DUAL TRIODE

Duodecar type used as combined vertical-deflection-oscillator and vertical-deflection-amplifier tube in television receivers. Outline 8B, **Outlines** section. Tube requires duodecar twelve-contact socket and may be mounted in

any position. Heater volts (ac/dc), 6.3; amperes, 0.9; peak heater-cathode volts, 200 (the dc component must not exceed 100 volts when the heater is positive with respect to the cathode).

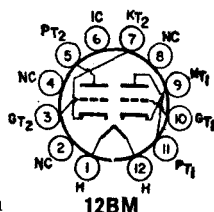

12BM

Class A<sub>1</sub> Amplifier

## CHARACTERISTICS:

	Unit No.1	Unit No.2	
Plate Voltage	250	150	250
Grid Voltage	-8	0	-9.5
Amplification Factor	22.5	—	15.4
Plate Resistance (Approx.)	9000	—	2000
Transconductance	2500	—	7700
Plate Current	8	68*	41
Grid Voltage (Approx.) for plate current of 10 $\mu$ A	-18	—	—
Grid Voltage (Approx.) for plate current of 50 $\mu$ A	—	—	-23

\* This value can be measured by a method involving a recurrent waveform such that the maximum ratings of the tube will not be exceeded.

## Vertical-Deflection Oscillator and Amplifier

For operation in a 525-line, 20-frame system

	Unit No.1 Oscillator	Unit No.2 Amplifier	
DC Plate Voltage	350 max	550 max	volts
Peak Positive-Pulse Plate Voltage*	—	2500 max	volts
Peak Negative-Pulse Grid Voltage	-400 max	-250 max	volts
Peak Cathode Current	—	150 max	mA
Average Cathode Current	—	50 max	mA
Plate Dissipation	1 max	10 max	watts

## MAXIMUM CIRCUIT VALUES:

Grid-Circuit Resistance:

For fixed-bias operation	2.2 max	2.2 max megohms
For cathode-bias operation	2.2 max	— megohms

\* The duration of the voltage pulse must not exceed 15 per cent of one vertical scanning cycle. In a 525-line, 30-frame system, 15 per cent of one vertical scanning cycle is 2.5 milliseconds.

## DUAL TRIODE

## 6FM7

Related types:  
13FM7, 15FM7

Duodecar type used as combined vertical-deflection oscillator and vertical-deflection amplifier in television receivers. The high- $\mu$  triode unit No.1 is used as an oscillator, and the low- $\mu$  triode unit No.2 is used as an amplifier. Outline 8B, **Outlines** section. Tube requires duodecar twelve-contact socket and may be mounted in any position. Types 13FM7 and 15FM7 are identical with type 6FM7 except for the heater ratings, as shown below.

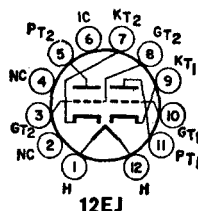

12EJ

	6FM7	13FM7	15FM7	
Heater Voltage (ac/dc)	6.3	13	14.8	volts
Heater Current	1.05	0.45	0.45	ampere
Heater Warm-up Time (Average)	—	11	11	seconds
Peak Heater-Cathode Voltage:				
Heater negative with respect to cathode	200 max	200 max	200 max	volts
Heater positive with respect to cathode	200 max	200 max	200 max	volts

\* The dc component must not exceed 100 volts.

**Class A<sub>1</sub> Amplifier**

<b>CHARACTERISTICS:</b>	Unit No.1	Unit No.2	
Plate Voltage .....	250	175	volts
Grid Voltage .....	-3	-25	volts
Amplification Factor .....	66	5.5	
Plate Resistance (Approx.) .....	30000	920	ohms
Transconductance .....	2200	6000	μmhos
Grid Voltage (Approx.) for plate current of 20 μA .....	-5.3	—	volts
Grid Voltage (Approx.) for plate current of 200 μA .....	—	-45	volts
Plate Current .....	2	40	mA

**Vertical-Deflection Oscillator and Amplifier**

For operation in a 525-line, 30-frame system

<b>MAXIMUM RATINGS</b> (Design-Maximum Values):	Unit No.1 Oscillator	Unit No.2 Amplifier	
DC Plate Voltage .....	350 max	550 max	volts
Peak Positive-Pulse Plate Voltage# .....	—	1500 max	volts
Peak Negative-Pulse Plate Voltage .....	-400 max	-250 max	volts
Peak Cathode Current .....	—	175 max	mA
Average Cathode Current .....	—	50 max	mA
Plate Dissipation† .....	1 max	10 max	watts

**MAXIMUM CIRCUIT VALUES:**

<b>Grid-Circuit Resistance:</b>			
For fixed-bias operation .....	1 max	1 max	megohm
For cathode-bias operation .....	2.2 max	2.2 max	megohms

# The duration of the voltage pulse must not exceed 15 per cent of one vertical scanning cycle. In a 525-line, 30-frame system, 15 per cent of one vertical scanning cycle is 2.5 milliseconds.

† An adequate bias resistor or other means is required to protect the tube in the absence of excitation.

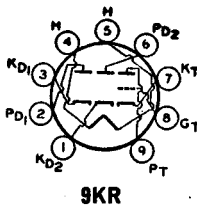

**TWIN DIODE—  
HIGH-MU TRIODE**

Miniature type used as combined FM detector and af voltage amplifier in FM receivers. Outline 6B, Outlines section. Tube requires miniature nine-contact socket and may be operated in any position. Heater volts (ac/dc),

**6FM8**

6.3; amperes, 0.45; peak heater-cathode volts, 200 (the dc component must not exceed 100 volts when the heater is positive with respect to the cathode).

**Triode Unit as Class A<sub>1</sub> Amplifier**

<b>MAXIMUM RATINGS</b> (Design-Maximum Values):			
Plate Voltage .....	330 max		volts
Grid Voltage, Positive-bias value .....	0 max		volts
Plate Dissipation .....	1.1 max		watts
<b>CHARACTERISTICS:</b>			
Plate Voltage .....	250		volts
Grid Voltage .....	-3		volts
Amplification Factor .....	70		
Plate Resistance (Approx.) .....	58000		ohms
Transconductance .....	1200		μmhos
Plate Current .....	1		mA

**Diode Units (Each Unit)**

<b>MAXIMUM RATINGS</b> (Design-Maximum Values):			
Plate Current .....	5 max		mA
<b>CHARACTERISTICS, Instantaneous Value:</b>			
Tube Voltage Drop for plate current of 20 mA .....	5		volts

## HIGH-MU TRIODE

## 6FQ5A

Miniature type with frame grid used as rf-amplifier tube in vhf tuners of television receivers. Outline 5C, **Outlines** section. Tube requires miniature seven-contact socket and may be mounted in any position.

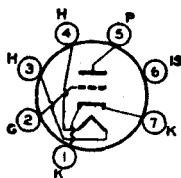

7FP

Heater Voltage (ac/dc) .....	6.3	volts
Heater Current .....	0.18	ampere
Peak Heater-Cathode Voltage:		
Heater negative with respect to cathode .....	100 max	volts
Heater positive with respect to cathode .....	100 max	volts
Direct Interelectrode Capacitances:*		
Grid to Plate .....	0.52	pF
Grid to Cathode, Heater, and Internal Shield .....	5	pF
Plate to Cathode, Heater, and Internal Shield .....	3.5	pF
Heater to Cathode .....	2.5 <sub>Δ</sub>	pF

\* With external shield connected to cathode except as noted.

Δ With external shield connected to ground.

Class A<sub>1</sub> Amplifier

## MAXIMUM RATINGS (Design-Maximum Values):

Plate Voltage .....	200 max	volts
Grid Voltage, Negative-bias value .....	-50 max	volts
Average Cathode Current .....	2.2 max	mA
Plate Dissipation .....	2.5 max	watts

## CHARACTERISTICS:

Plate Voltage .....	135	volts
Grid Voltage .....	-1.2	volts
Amplification Factor .....	74	
Plate Resistance (Approx.) .....	6300	ohms
Transconductance .....	12000	μmhos
Plate Current .....	8.9	mA
Grid Voltage (Approx.) for plate current of 100 μA .....	-4.5	volts

## MAXIMUM CIRCUIT VALUES:

Grid-Circuit Resistance:		
For cathode-bias operation .....	1 max	megohm

6FQ7/  
6CG7

Related type:  
8FQ7/8CG7

## MEDIUM-MU TWIN TRIODE

Miniature type used as combined vertical- and horizontal-deflection oscillator in television receivers. Outline 6E, **Outlines** section. Tube requires miniature nine-contact socket and may be operated in any position. Type

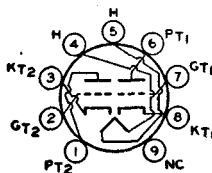

9LP

8FQ7/8CG7 is identical with type 6FQ7/6CG7 except for the heater ratings. For typical operation as a resistance-coupled amplifier, refer to **Resistance-Coupled Amplifier** section.

	6FQ7/6CG7	8FQ7/8CG7	
Heater Voltage (ac/dc) .....	6.3	8.4	volts
Heater Current .....	0.6	0.45	ampere
Heater Warm-up Time (Average) .....	11	—	seconds
Peak Heater-Cathode Voltage:			
Heater negative with respect to cathode .....	200 max	200 max	volts
Heater positive with respect to cathode .....	200 max	200 max	volts
Direct Interelectrode Capacitances (Approx.):			
Grid to Plate .....	Unit No.1	Unit No.2	
Grid to Cathode and Heater .....	3.6	3.8	pF
Plate to Cathode and Heater .....	2.4	2.4	pF
Plate of Unit No.1 to Plate of Unit No.2 .....	0.34	0.26	pF

• The dc component must not exceed 100 volts.



**Class A<sub>1</sub> Amplifier (Each Unit)**

**MAXIMUM RATINGS (Design-Maximum Values):**

Plate Voltage .....	330 max	volts
Grid Voltage, Positive-bias value .....	0 max	volts
Plate Dissipation:		
For either plate .....	4 max	watts
For both plates with both units operating .....	5.7 max	watts
Cathode Current .....	22 max	mA

**CHARACTERISTICS:**

Plate Voltage .....	90	250	volts
Grid Voltage .....	0	-8	volts
Amplification Factor .....	20	20	
Plate Resistance (Approx.) .....	6700	7700	ohms
Transconductance .....	3000	2600	μmhos
Grid Voltage (Approx.) for plate current of 10 μA .....	-7	-18	volts
Plate Current for grid voltage of -12.5 volts .....	—	1.3	mA
Plate Current .....	10	9	mA

**MAXIMUM CIRCUIT VALUE:**

Grid-Circuit Resistance:	
For fixed-bias operation .....	1.0 max megohm

**Oscillator**

For operation in a 525-line, 30-frame system

<b>MAXIMUM RATINGS (Design-Maximum Values, Each Unit):</b>	Vertical Deflection Oscillator	Horizontal Deflection Oscillator	
	DC Plate Voltage .....	330 max	330 max
Peak Negative-Pulse Grid Voltage .....	-440 max	-660 max	volts
Peak Cathode Current .....	77 max	330 max	mA
Average Cathode Current .....	22 max	22 max	mA
Plate Dissipation:			
For either plate .....	4 max	4 max	watts
For both plates with both units operating .....	5.7 max	5.7 max	watts

**MAXIMUM CIRCUIT VALUE:**

Grid-Circuit Resistance .....	2.2 max	2.2 max megohms
-------------------------------	---------	-----------------

**AVERAGE PLATE CHARACTERISTICS FOR EACH UNIT**

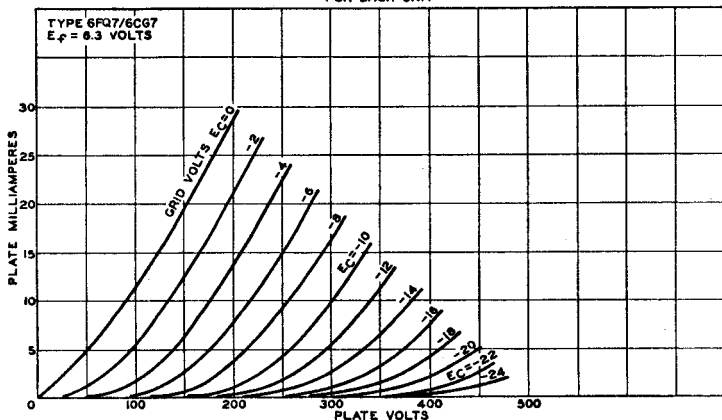

## BEAM HEXODE

**6FS5**

Related type:  
2FS5

Miniature type used as rf-amplifier tube in vhf television receivers. In this tube, grid No.1 is the control grid, grid No.2 is a focusing grid, grid No.3 is the screen grid, and grid No.4 is the suppressor grid. Grid No.2 is inter-

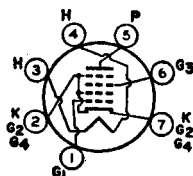

7GA

nally connected to the cathode and grid No.4, and aligned with grid No.3. Outline 5C, **Outlines** section. Tube requires miniature seven-contact socket and may be mounted in any position. Type 2FS5 is identical with type 6FS5 except for the heater ratings, as shown below.

	2FS5	6FS5	
Heater Voltage (ac/dc) .....	2.4	6.3	volts
Heater Current .....	0.6	0.2	ampere
Heater Warm-up Time (Average) .....	11	—	seconds
<b>Peak Heater-Cathode Voltage:</b>			
Heater negative with respect to cathode .....	200 max	200 max	volts
Heater positive with respect to cathode .....	200*max	200*max	volts
<b>Direct Interelectrode Capacitances:</b>			
Grid No.1 to Plate .....	Without External Shield	With External Shield*	pF
Grid No.1 to Cathode, Heater, Grid No.2, Grid No.3, and Grid No.4 .....	0.03	0.016	
Plate to Cathode, Heater, Grid No.2, Grid No.3, and Grid No.4 .....	4.8	4.8	pF
	2	2.8	pF

\* The dc component must not exceed 100 volts.

■ With external shield connected to pin 7.

Class A<sub>1</sub> Amplifier

## MAXIMUM RATINGS (Design-Maximum Values):

Plate Voltage .....	300 max	volts
Grid-No.3 (Screen-Grid) Voltage .....	150 max	volts
Grid-No.1 (Control-Grid) Voltage:		
Negative-bias value .....	—50 max	volts
Positive-bias value .....	0 max	volts
Cathode Current .....	20 max	mA
Grid-No.3 Input .....	0.15 max	watt
Plate Dissipation .....	3.25 max	watts

## CHARACTERISTICS:

Plate Voltage .....	275	volts
Grid-No.3 Voltage .....	135	volts
Grid-No.1 Voltage .....	—0.2	volt
Plate Resistance (Approx.) .....	0.24	megohm
Transconductance .....	10000	μmhos
Plate Current .....	9	mA
Grid-No.3 Current .....	0.17	mA
Grid-No.1 Voltage (Approx.) for transconductance of 100 μmhos .....	—5	volts

## MAXIMUM CIRCUIT VALUES:

Grid-No.1-Circuit Resistance, for fixed-bias operation .....	0.5 max	megohm
--	---------	--------

## SHARP-CUTOFF TETRODE

Miniature type used as rf amplifier in vhf tuners of television receivers. Outline 5C, **Outlines** section. Tube requires seven-contact socket and may be mounted in any position.

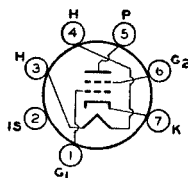
**6FV6**

7FQ

Heater Voltage (ac/dc) .....	6.3	volts
Heater Current .....	0.2	ampere
Peak Heater-Cathode Voltage:		
Heater negative with respect to cathode .....	200 max	volts
Heater positive with respect to cathode .....	200*max	volts
Direct Interelectrode Capacitances: <sup>o</sup>		
Grid No.1 to Plate .....	0.03 max	pF
Grid No.1 to Cathode, Heater, Grid No.2, and Internal Shield ...	4.5	pF
Plate to Cathode, Heater, Grid No.2, and Internal Shield .....	3	pF
Cathode to Heater .....	2.7*	pF

- \* The dc component must not exceed 100 volts.
- ° With external shield connected to cathode except as noted.
- With external shield connected to ground.

**Class A<sub>1</sub> Amplifier**

**MAXIMUM RATINGS (Design-Maximum Values):**

Plate Voltage .....	275 max	volts
Grid-No.2 (Screen-Grid) Supply Voltage .....	180 max	volts
Grid-No.2 Voltage .....	See curve page 80	
Grid-No.1 (Control-Grid) Voltage, Positive-bias value .....	0 max	volts
Cathode Current .....	20 max	mA
Grid-No.2 Input:		
For grid-No.2 voltages up to 90 volts .....	0.5 max	watt
For grid-No.2 voltages between 90 and 180 volts .....	See curve page 80	
Plate Dissipation .....	2 max	watts

**CHARACTERISTICS:**

Plate Voltage .....	125	volts
Grid-No.2 Voltage .....	80	volts
Grid-No.1 Voltage .....	-1	volt
Plate Resistance (Approx.) .....	0.1	megohm
Transconductance .....	8000	μmhos
Plate Current .....	10	mA
Grid-No.2 Current .....	1.5	mA
Grid-No. 1 Voltage (Approx.) for plate current of 20 μA .....	-6	volts

**MAXIMUM CIRCUIT VALUES:**

Grid-No.1-Circuit Resistance .....	0.5 max	megohm
------------------------------------	---------	--------

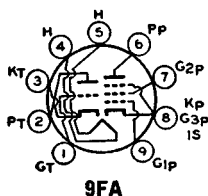

9FA

**MEDIUM-MU TRIODE—  
SHARP-CUTOFF PENTODE**

Miniature type used in television receivers as combined oscillator and amplifier. Triode is used as vertical deflection oscillator; pentode is used as if or general-purpose amplifier. Outline 6B, **Outlines** section. Tube

**6FV8A**

Related type:  
5FV8

requires nine-contact socket and may be operated in any position. Type 5FV8 is identical with type 6FV8A except for the heater ratings, as shown below.

	5FV8	6FV8A	
Heater Voltage (ac/dc) .....	4.7	6.3	volts
Heater Current .....	0.6	0.45	ampere
Heater Warm-up Time (Average) .....	11	11	seconds
Peak Heater-Cathode Voltage:			
Heater negative with respect to cathode .....	200 max	200 max	volts
Heater positive with respect to cathode .....	200*max	200*max	volts
Direct Interelectrode Capacitances:			
Triode Unit:			
Grid to Plate .....	1.8	1.8	pF
Grid to Cathode, Heater, Pentode Cathode, Pentode Grid No.3, and Internal Shield .....	2.8	2.8	pF
Plate to Cathode, Heater, Pentode Cathode, Pentode Grid No.3, and Internal Shield .....	1.5	2	pF

<b>Pentode Unit:</b>			
Grid No.1 to Plate .....	0.02 max	0.01 max	pF
Grid No.1 to Cathode, Heater, Grid No.2, Grid No.3, and Internal Shield .....	5	5	pF
Plate to Cathode, Heater, Grid No.2, Grid No.3, and Internal Shield .....	2	3	pF
Pentode Plate to Triode Plate .....	0.15 max	0.03 max	pF

\* The dc component must not exceed 100 volts.

**Class A<sub>1</sub> Amplifier**

Pentode Unit

**MAXIMUM RATINGS (Design-Center Values):**

Plate Voltage .....	330 max	volts
Grid-No.2 (Screen-Grid) Supply Voltage .....	330 max	volts
Grid-No.2 Voltage .....	See curve page 80	
Grid-No.1 (Control-Grid) Voltage, Positive-bias value .....	0 max	volts
Plate Dissipation .....	2.3 max	watts
Grid-No.2 Input:		
For grid-No.2 voltages up to 165 volts .....	0.55 max	watt
For grid-No.2 voltages between 165 and 330 volts .....	See curve page 80	

**MAXIMUM CIRCUIT VALUES:**

Grid-No.1-Circuit Resistance:		
For fixed-bias operation .....	0.25 max	megohm
For cathode-bias operation .....	1 max	megohm

**CHARACTERISTICS:**

	Triode Unit	Pentode Unit	
Plate Voltage .....	125	125	volts
Grid-No.2 Voltage .....	—	125	volts
Grid-No.1 Voltage .....	-1	-1	volt
Amplification Factor .....	45	—	
Plate Resistance (Approx.) .....	5600	200000	ohms
Transconductance .....	8000	6500	$\mu$ mhos
Grid-No.1 Voltage (Approx.) for plate current of 20 $\mu$ A .....	-7.5	-9	volts
Plate Current .....	12	12	mA
Grid-No.2 Current .....	—	4	mA

**Vertical-Deflection Oscillator—Triode Unit**

For operation in a 525-line, 30-frame system

**MAXIMUM RATINGS (Design-Maximum Values):**

DC Plate Voltage .....	330 max	volts
Peak Negative-Pulse Grid Voltage .....	-250 max	volts
Peak Cathode Current .....	70 max	mA
Average Cathode Current .....	20 max	mA
Plate Dissipation .....	2 max	watts

**MAXIMUM CIRCUIT VALUES:**

Grid-Circuit Resistance:	
For cathode-bias operation .....	3 max megohms

**BEAM POWER TUBE****6FW5**

Glass octal type used as horizontal-deflection amplifier in television receivers. Outline 19B, **Outlines** section. Tube requires octal socket and may be mounted in any position. Heater volts (ac/dc), 6.3; amperes, 1.2; peak

heater-cathode volts, 200 (the dc component must not exceed 100 volts when the heater is positive with respect to the cathode).

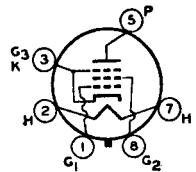
**6CK****Horizontal-Deflection Amplifier**

For operation in a 525-line, 30-frame system

**MAXIMUM RATINGS (Design-Maximum Values):**

DC Plate Voltage .....	770 max	volts
Peak Positive-Pulse Plate Voltage <sup>o</sup> .....	6500 max	volts
DC Grid-No.2 (Screen-Grid) Voltage .....	220 max	volts
Peak Negative-Pulse Grid-No.1 Voltage .....	-330 max	volts
DC Grid-No.1 (Control-Grid) Voltage .....	-55 max	volts

Peak Cathode Current .....	610 max	mA
Average Cathode Current .....	175 max	mA
Grid-No.2 Input .....	3.6 max	watts
Plate Dissipation* .....	18 max	watts
Bulb Temperature (At hottest point) .....	220 max	°C

**MAXIMUM CIRCUIT VALUES:**

Grid-No.1-Circuit Resistance .....	1 max	megohm
------------------------------------	-------	--------

\* The duration of the voltage pulse must not exceed 15 per cent of one horizontal scanning cycle. In a 525-line, 30-frame system, 15 per cent of one horizontal scanning cycle is 10 microseconds.

\* An adequate bias resistor or other means is required to protect the tube in the absence of excitation.

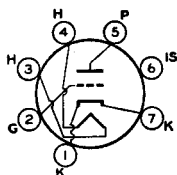

**7FP**

**HIGH-MU TRIODE**

Miniature type with frame grid used for rf-amplifier applications in vhf tuners of television receivers. Outline 5C, **Outlines** section. Tube requires miniature seven-contact socket and may be mounted in any position.

**6FY5/  
EC97**

Heater Voltage (ac/dc) .....	6.3	volts
Heater Current .....	0.2	ampere
Peak Heater-Cathode Voltage:		
Heater negative with respect to cathode .....	100 max	volts
Heater positive with respect to cathode .....	100 max	volts

Direct Interelectrode Capacitances:	Without External Shield	With External Shield	
Grid to Plate .....	0.50	0.48	pF
Grid to Cathode, Heater, and Internal Shield .....	4.75	4.75	pF
Plate to Cathode, Heater, and Internal Shield .....	3.3	4.3	pF
Grid to Heater .....	0.28 max	0.28 max	pF
Plate to Cathode .....	0.25	0.21	pF
Cathode to Grid .....	3.2	3.2	pF
Heater to Cathode .....	2.5	2.5	pF

**Class A<sub>1</sub> Amplifier**

**MAXIMUM RATINGS (Absolute-Maximum Values):**

Plate Supply Voltage .....	550 max	volts
Plate Voltage .....	200 max	volts
Grid Voltage, Negative-bias Value .....	-50 max	volts
Cathode Current .....	20 max	mA
Plate Dissipation .....	2.2 max	watts

**CHARACTERISTICS:**

Plate Voltage .....	135	135	135	135	volts
Grid Voltage .....	-1	-3.1	-5	-4.5	volts
Transconductance .....	13000	625	125	—	μmhos
Amplification Factor .....	70	—	—	—	
Plate Current .....	11	—	—	0.1	mA

**MAXIMUM CIRCUIT VALUE:**

Cathode-Heater Circuit Resistance .....	0.02 max	megohm
Grid-Circuit Resistance .....	1 max	megohm

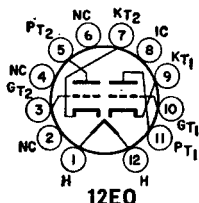

**12E0**

**DUAL TRIODE**

Duodecar type used as combined vertical-deflection oscillator and vertical-deflection amplifier in television receivers. The high-mu triode unit No.1 is used as an oscillator, and the low-mu triode unit No.2 is used as an am-

**6FY7**

Related type:  
15FY7

plifier. Outline 8D, **Outlines** section. Tube requires duodecap twelve-contact socket and may be mounted in any position. Type 15FY7 is identical with type 6FY7 except for the heater ratings, as shown below.

Heater Voltage (ac/dc) .....	6FY7 6.3	15FY7 14.7	volts
Heater Current .....	1.05	0.45	ampere
Heater Warm-up Time (Average) .....	—	11	seconds
<b>Peak Heater-Cathode Voltage:</b>			
Heater negative with respect to cathode .....	200 max	200 max	volts
Heater positive with respect to cathode .....	200*max	200*max	volts

\* The dc component must not exceed 100 volts.

### Class A<sub>1</sub> Amplifier

CHARACTERISTICS:	Unit No.1	Unit No.2	
Plate Voltage .....	250	150	volts
Grid Voltage .....	-3	-17.5	volts
Amplification Factor .....	65	6	
Plate Resistance (Approx.) .....	40500	800	ohms
Transconductance .....	1600	7500	μmhos
Grid Voltage (Approx.) for plate current of 30 μA .....	-5.5	—	volts
Grid Voltage (Approx.) for plate current of 50 μA .....	—	-5.5	volts
Plate Current .....	1.4	45	mA
Plate Current (Approx.) for grid voltage of -25 volts .....	—	10	mA

### Vertical-Deflection Oscillator and Amplifier

For operation in a 525-line, 30-frame system

MAXIMUM RATINGS (Design-Maximum Values):	Unit No.1 Oscillator	Unit No.2 Amplifier	
DC Plate Voltage .....	330 max	275 max	volts
Peak Positive-Pulse Plate Voltage# .....	—	2000 max	volts
Peak Negative-Pulse Plate Voltage .....	-400 max	-250 max	volts
Peak Cathode Current .....	70 max	175 max	mA
Average Cathode Current .....	20 max	50 max	mA
Plate Dissipation .....	1 max	7†max	watts

#### MAXIMUM CIRCUIT VALUES:

Grid-Circuit Resistance .....	2.2 max	2.2 max megohms
-------------------------------	---------	-----------------

# The duration of the voltage pulse must not exceed 15 per cent of one vertical scanning cycle. In a 525-line, 30-frame system, 15 per cent of one vertical scanning cycle is 2.5 milliseconds.

† An adequate bias resistor or other means is required to protect the tube in the absence of excitation.

## BEAM POWER TUBE

# 6GB5

Related types:  
13GB5, 27GB5/PL500

Neonovial type used as horizontal-deflection amplifier in television receivers. Outline 10E, **Outlines** section. Tube requires neonovial nine-contact socket and may be mounted in any position. Typical instantaneous characteristics

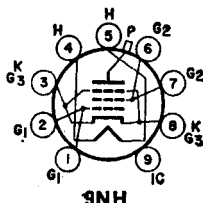

(measured with recurrent waveform such that maximum ratings are not exceeded): plate volts, 75; grid-No.2 volts, 200; grid-No.1 volts, -10; plate mA., 440; grid-No.2 mA, 37. Types 13GB5 and 27GB5/PL500 are identical with type 6GB5 except for heater ratings, as shown below.

	6GB5	13GB5	27GB5/ PL500	
Heater Voltage (ac/dc) .....	6.3	13.3	27	volts
Heater Current .....	1.38	0.6	0.3	amperes
<b>Peak Heater-Cathode Voltage:</b>				
Heater negative with respect to cathode ..	250 max	250 max	250 max	volts
Heater positive with respect to cathode ..	250*max	250*max	250*max	volts

\* The dc component must not exceed 125 volts.

**Horizontal-Deflection Amplifier**

For operation in a 525-line, 30-frame system

**MAXIMUM RATINGS (Design-Maximum Values):**

DC Grid-No.2 (Screen-Grid) Voltage .....	275 max	volts
Peak Positive-Pulse Plate Voltage* .....	7700 max	volts
DC Grid-No.2 (Screen-Grid) Voltage .....	275 max	volts
Average Cathode Current .....	275 max	mA
Grid-No.2 Input* .....	5 max	watts
Plate Dissipation <sup>Δ</sup> .....	17 max	watts

**MAXIMUM CIRCUIT VALUES:**

Grid-No.1-Circuit Resistance .....	2.2 max megohms
------------------------------------	-----------------

- The duration of the voltage pulse must not exceed 15 per cent of one horizontal scanning cycle. In a 525-line, 30-frame system, 15 per cent of one horizontal scanning cycle is 10 microseconds.
- Grid-No.2 input may reach 6 watts for plate-dissipation values below 11 watts.
- Δ An adequate bias resistor or other means is required to protect the tube in the absence of excitation.

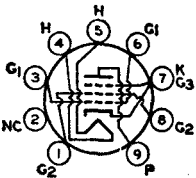

**BEAM POWER TUBE**

Neonoval type used as output tube in audio-amplifier applications. Outline 10D, Outlines section. Tube requires neonoval nine-contact socket and may be mounted in any position.

**6GC5**

**9EV**

Heater Voltage (ac/dc) .....	6.3	volts
Heater Current .....	1.2	ampere
Peak Heater-Cathode Voltage:		
Heater negative with respect to cathode .....	200 max	volts
Heater positive with respect to cathode .....	200 max	volts
Direct Interelectrode Capacitances (Approx.):		
Grid No.1 to Plate .....	0.9	pF
Grid No.1 to Cathode, Heater, Grid No.2, and Grid No.3 .....	18	pF
Plate to Cathode, Heater, Grid No.2, and Grid No.3 .....	7	pF

- The dc component must not exceed 100 volts.

**Class A<sub>1</sub> Amplifier**

**MAXIMUM RATINGS (Design-Maximum Values):**

Plate Voltage .....	220 max	volts
Grid-No.2 (Screen-Grid) Voltage .....	140 max	volts
Grid-No.2 Input .....	1.4 max	watts
Plate Dissipation .....	12 max	watts

**AVERAGE PLATE CHARACTERISTICS**

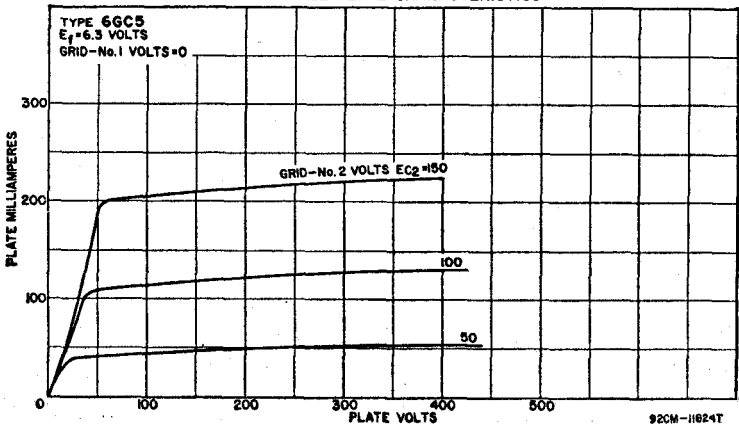

**TYPICAL OPERATION AND CHARACTERISTICS:**

Plate Voltage	110	200	volts
Grid-No.2 Voltage	110	125	volts
Grid-No.1 Voltage	-7.5	—	volts
Cathode-Bias Resistor	—	180	ohms
Peak AF Grid-No.1 Voltage	7.5	8.5	volts
Zero-Signal Plate Current	49	46	mA
Maximum-Signal Plate Current	50	47	mA
Zero-Signal Grid-No.2 Current	4	2.2	mA
Maximum-Signal Grid-No.2 Current	10	8.5	mA
Plate Resistance (Approx.)	13000	28000	ohms
Transconductance	8000	8000	$\mu$ mhos
Load Resistance	2000	4000	ohms
Total Harmonic Distortion	10	10	per cent
Maximum-Signal Power Output	2.1	3.8	watts

**MAXIMUM CIRCUIT VALUES:**

Grid-No.1-Circuit Resistance:

For fixed-bias operation

0.1 max megohm

For cathode-bias operation

0.5 max megohm

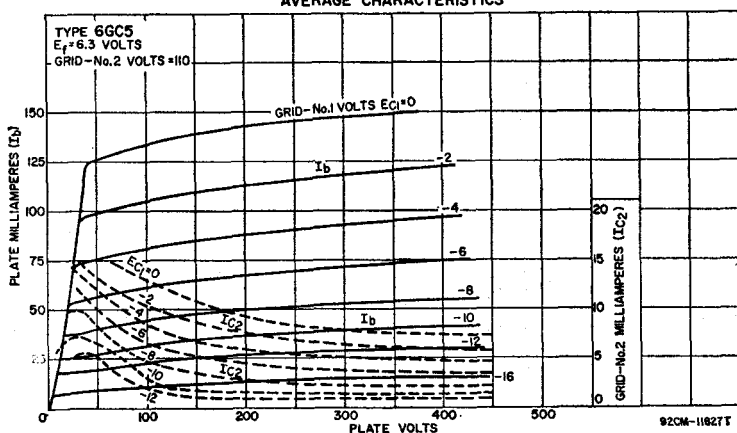
**AVERAGE CHARACTERISTICS****BEAM POWER TUBE****6GE5**Related types:  
12GE5, 17GE5

Duodec type used as horizontal-deflection-amplifier tube in television receivers. Outline 15A, Outlines section. Tube requires duodec twelve-contact socket and may be mounted in any position. Types 12GE5 and

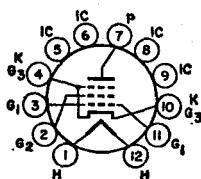
**12BJ**

17GE5 are identical with type 6GE5 except for the heater ratings, as shown below.

	6GE5	12GE5	17GE5	
Heater Voltage (ac/dc)	6.3	12.6	16.8	volts
Heater Current	1.2	0.6	0.45	ampere
Heater Warm-up Time (Average)	—	11	11	seconds
Peak Heater-Cathode Voltage:				
Heater negative with respect to cathode	200 max	200 max	200 max	volts
Heater positive with respect to cathode	200=max	200=max	200=max	volts

\* The dc component must not exceed 100 volts.



**Class A<sub>1</sub> Amplifier**

**CHARACTERISTICS:**

Plate Voltage	60	250	volts
Grid-No.2 (Screen-Grid) Voltage	150	150	volts
Grid-No.1 (Control-Grid) Voltage	0	-22.5	volts
Triode Amplification Factor*	—	4.4	
Plate Resistance (Approx.)	—	18000	ohms
Transconductance	—	7300	μmhos
Plate Current	345*	65	mA
Grid-No.2 Current	27*	1.8	mA
Grid-No.1 Voltage (Approx.) for plate current of 1 mA	—	-42	volts

\* Triode connection (grid No.2 tied to plate); plate and grid-No.2 volts = 150.

• This value can be measured by a method involving a recurrent waveform such that the maximum ratings of the tube will not be exceeded.

**Horizontal-Deflection Amplifier**

For operation in a 525-line, 30-frame system

**MAXIMUM RATINGS (Design-Maximum Values):**

DC Plate Supply Voltage	770 max	volts
Peak Positive-Pulse Plate Voltage#	6500 max	volts
Peak Negative-Pulse Plate Voltage	-1500 max	volts
DC Grid-No.2 Voltage	220 max	volts
Peak Negative-Pulse Grid-No.1 Voltage	-330 max	volts
DC Grid-No.1 Voltage	-55 max	volts
Peak Cathode Current	550 max	mA
Average Cathode Current	175 max	mA
Plate Dissipation†	17.5 max	watts
Grid-No.2 Input	3.5 max	watts
Bulb Temperature (At hottest point)	200 max	°C

**MAXIMUM CIRCUIT VALUES:**

Grid-No.1-Circuit Resistance ..... 1 max megohm  
 # The duration of the voltage pulse must not exceed 15 per cent of one horizontal scanning cycle. In a 525-line, 30-frame system, 15 per cent of one horizontal scanning cycle is 10 microseconds.

† An adequate bias resistor or other means is required to protect the tube in the absence of excitation.

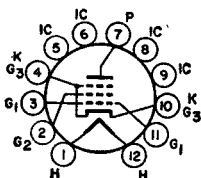

12BJ

**BEAM POWER TUBE**

Duodecar type used as horizontal-deflection amplifier in television receivers. Outline 8D, Outlines section. Tube requires duodecar twelve-contact socket and may be mounted in any position. Heater volts (ac/dc),

**6GF5**

6.3; amperes, 1.2; peak heater-cathode volts, 200 (the dc component must not exceed 100 volts when the heater is positive with respect to the cathode).

**Class A<sub>1</sub> Amplifier**

**CHARACTERISTICS:**

Plate Voltage	60	250	volts
Grid-No.2 (Screen-Grid) Voltage	150	150	volts
Grid-No.1 (Control-Grid) Voltage	0	-26.5	volts
Triode Amplification Factor*	—	4.2	
Plate Resistance (Approx.)	—	0.26	megohm
Transconductance	—	4700	μmhos
Plate Current	345*	34	mA
Grid-No.2 Current	33*	1.6	mA
Grid-No.1 Voltage (Approx.) for plate current of 1 mA	—	-46	volts

\* Triode connection (grid No.2 connected to plate); plate and grid-No.2 volts = 150.

• These values can be measured by a method involving a recurrent waveform such that the maximum ratings of the tube will not be exceeded.

**Horizontal-Deflection Amplifier**

For operation in a 525-line, 30-frame system

**MAXIMUM RATINGS (Design-Maximum Values):**

DC Plate Supply Voltage	770 max	volts
Peak Positive-Pulse Plate Voltage#	5000 max	volts

Peak Negative-Pulse Plate Voltage .....	-1500 max	volts
DC Grid-No.2 Voltage .....	220 max	volts
Peak Negative-Pulse Grid-No.1 Voltage .....	-330 max	volts
Negative DC Grid-No.1 Voltage .....	-55 max	volts
Peak Cathode Current .....	500 max	mA
Average Cathode Current .....	160 max	mA
Plate Dissipation† .....	9 max	watts
Grid-No.2 Input .....	2.5 max	watts
Bulb Temperature (At hottest point) .....	200 max	°C

**MAXIMUM CIRCUIT VALUES:**

Grid-No.1-Circuit Resistance ..... 1 max megohm

# The duration of the voltage pulse must not exceed 15 per cent of one horizontal scanning cycle. In a 525-line, 30-frame system, 15 per cent of one horizontal scanning cycle is 10 microseconds.

† An adequate bias resistor or other means is required to protect the tube in the absence of excitation.

**6GF7  
6GF7A**

Related types:  
10GF7, 10GF7A,  
13GF7, 13GF7A

**DUAL TRIODE**

Novar types containing high-mu and high-perveance, low-mu triode units used as combined vertical-deflection oscillator and vertical-deflection amplifiers in television receivers. Outlines 11A and 30A, respectively, **Outlines**

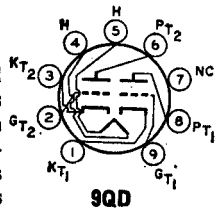

**9QD**

section. Tubes require novar nine-contact socket and may be mounted in any position. For curves of average plate characteristics for Unit No.1 and Unit No.2, refer to types 6DR7 (Unit No.1) and 6EM7, respectively. Types 10GF7 and 10GF7A and types 13GF7 and 13GF7A are identical with types 6GF7 and 6GF7A except for the heater ratings, as shown below.

	6GF7	10GF7	13GF7	
	6GF7A	10GF7A	13GF7A	
Heater Voltage (ac/dc) .....	6.3	9.7	13	volts
Heater Current .....	0.985	0.6	0.45	ampere
Heater Warm-up Time (Average) .....	—	11	11	seconds
Peak Heater-Cathode Voltage:				
Heater negative with respect to cathode ...	200 max	200 max	200 max	volts
Heater positive with respect to cathode ...	200*max	200*max	200*max	volts
Direct Interelectrode Capacitances (Approx.)		Unit No.1	Unit No.2	
Grid to Plate .....		4.6	9	pF
Grid to Cathode and Heater .....		2.4	6.5	pF
Plate to Cathode and Heater .....		0.26	1.4	pF

\* The dc component must not exceed 100 volts.

**Class A<sub>1</sub> Amplifier**

<b>CHARACTERISTICS:</b>	Unit No.1	Unit No.2	
Plate Voltage .....	250	150	volts
Grid Voltage .....	-3	-20	volts
Amplification Factor .....	64	5.4	
Plate Resistance (Approx.) .....	4000	750	ohms
Transconductance .....	1600	7200	μmhos
Grid Voltage (Approx.):			
For plate current of 10 μA .....	-5.5	—	volts
For plate current of 100 μA .....	—	-45	volts
Plate Current .....	1.4	50	mA
For plate voltage of 60 volts and zero grid voltage	—	95	mA
For grid voltage of -28 volts .....	—	10	mA

**Vertical-Deflection Oscillator and Amplifier**

For operation in a 525-line, 30-frame system

<b>MAXIMUM RATINGS (Design-Maximum Values):</b>	Unit No.1	Unit No.2	
DC Plate Voltage .....	330 max	330 max	volts
Peak Positive-Pulse Plate Voltage (Absolute Maximum)# .....	—	1500*max	volts
Peak Negative-Pulse Grid Voltage .....	-400 max	-250 max	volts
Peak Cathode Current .....	77 max	175 max	mA
Average Cathode Current .....	22 max	50 max	mA
Plate Dissipation .....	1.5 max	11 max	watts

**MAXIMUM CIRCUIT VALUES:**

Grid-Circuit Resistance:

For grid-resistor-bias or cathode-bias operation . . . 2.2 max 2.2 max megohms

\* Under no circumstances should this absolute value be exceeded.

# The duration of the voltage pulse must not exceed 15 per cent of one vertical scanning cycle. In a 525-line, 30-frame system, 15 per cent of one vertical scanning cycle is 2.5 milliseconds.

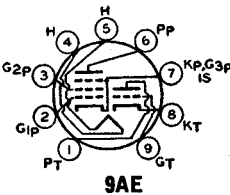

**MEDIUM-MU TRIODE—  
SHARP-CUTOFF PENTODE**

Miniature type used in multivibrator-type horizontal-deflection circuits in television receivers. Also used for agc-amplifier or sync-separator applications in such receivers. Outline 6B, Outlines section. Tube requires minia-

**6GH8A**

Related type:  
5GH8

ture nine-contact socket and may be mounted in any position. This type is specially controlled to assure low interelectrode leakage. Type 5GH8 is identical with type 6GH8A except for the heater ratings, as shown below.

	5GH8	6GH8A	
Heater Voltage (ac/dc) . . . . .	4.7	6.3	volts
Heater Current . . . . .	0.6	0.45	ampere
Heater Warm-up Time (Average) . . . . .	11	11	seconds
Peak Heater-Cathode Voltage:			
Heater negative with respect to cathode . . . . .	200 max	200 max	volts
Heater positive with respect to cathode . . . . .	200*max	200*max	volts
Direct Interelectrode Capacitances:			
Triode Unit:			
Grid to Plate . . . . .		1.7	pF
Grid to Cathode, Heater, Pentode Grid No.3, Pentode Cathode, and Internal Shield . . . . .		3	pF
Plate to Cathode, Heater, Pentode Grid No.3, Pentode Cathode, and Internal Shield . . . . .		1.4	pF
Heater to Cathode . . . . .		3	pF
Pentode Unit:			
Grid No.1 to Plate . . . . .		0.02 max	pF
Grid No.1 to Cathode, Heater, Grid No.2, Grid No.3, and Internal Shield . . . . .		5	pF
Plate to Cathode, Heater, Grid No.2, Grid No.3, and Internal Shield . . . . .		2.6	pF
Heater to Cathode, Grid No.3, and Internal Shield . . . . .		3	pF

\* The dc component must not exceed 100 volts.

**Class A<sub>1</sub> Amplifier**

**CHARACTERISTICS:**

	Triode Unit	Pentode Unit	
Plate Voltage . . . . .	125	125	volts
Grid-No.2 Voltage . . . . .	—	125	volts
Grid-No.1 Voltage . . . . .	—1	—1	volts
Amplification Factor . . . . .	46	—	
Plate Resistance (Approx.) . . . . .	5400	20000	ohms
Transconductance . . . . .	8500	7500	μmhos
Plate Current . . . . .	13.5	12	mA
Grid-No.2 Current . . . . .	—	4	mA
Grid-No.1 Voltage (Approx.) for plate current of 10 μA . . . . .	—8	—8	volts

**Horizontal-Deflection Oscillator**

For operation in a 525-line, 30-frame system

**MAXIMUM RATINGS (Design-Maximum Values):**

	Triode Unit	Pentode Unit	
Plate Voltage . . . . .	330 max	350 max	volts
Grid-No.2 (Screen-Grid) Voltage . . . . .	—	330 max	volts
Grid-No.1 (Control-Grid) Voltage:			
Positive-bias value . . . . .	0 max	0 max	volts
Peak negative value . . . . .	—	—175 max	volts
Peak Cathode Current . . . . .	—	300 max	mA

Average Cathode Current .....	Triode Unit	Pentode Unit	
Grid-No.2 Input .....	—	20 max	mA
Plate Dissipation .....	—	0.55 max	watt
	2.5 max	2.5 max	watts

**MAXIMUM CIRCUIT VALUES:**

Grid-No.1-Circuit Resistance:			
For fixed-bias operation .....	2.2 max	2.2 max	megohms
For cathode-bias operation .....	2.2 max	2.2 max	megohms

**AVERAGE PLATE CHARACTERISTICS**

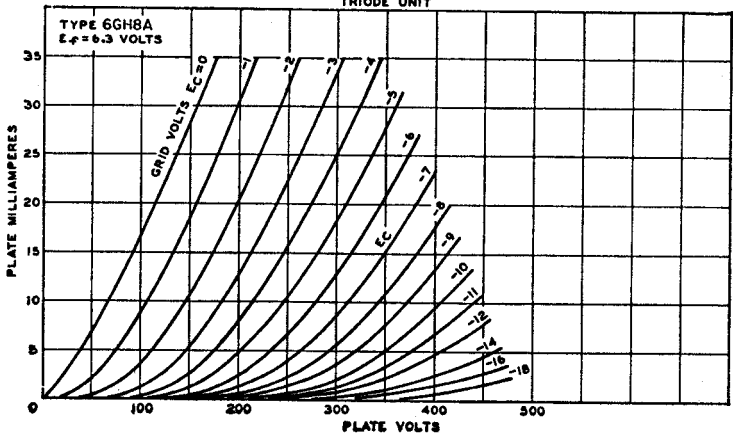

92CM-10421(I)

**AVERAGE CHARACTERISTICS**

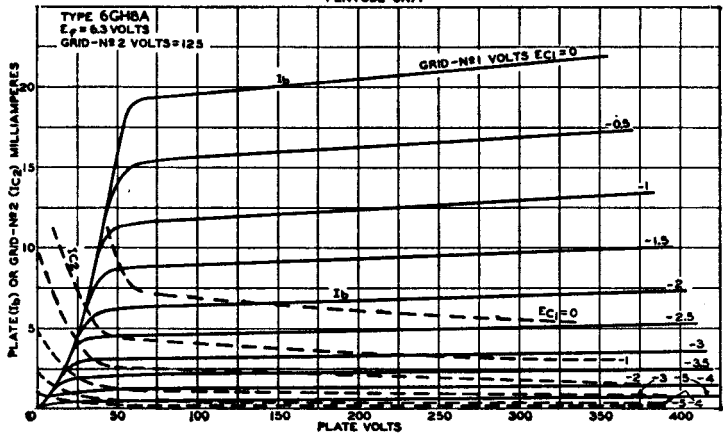

**BEAM POWER TUBE**

**6GJ5A**

Related types:  
12GJ5A, 17GJ5A

Novar type used in high-efficiency horizontal-deflection-amplifier circuits of television receivers. Outline 32, **Outlines** section. Tube requires novar nine-contact socket and may be operated in any position. For curve of

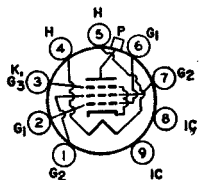

**9QK**

average characteristics see type 6GW6. Types 12GJ5A and 17GJ5A are identical

with type 6GJ5A except for the heater ratings, as shown below.

	6GJ5A	12GJ5A	17GJ5A	
Heater Voltage (ac/dc) .....	6.3	12.6	16.8	volts
Heater Current .....	1.2	0.6	0.45	ampere
Heater Warm-up Time (Average) .....	—	11	11	seconds
Peak Heater-Cathode Voltage:				
Heater negative with respect to cathode ...	200 max	200 max	200 max	volts
Heater positive with respect to cathode ...	200=max	200=max	200=max	volts
Direct Interelectrode Capacitances (Approx.):				
Grid No.1 to Plate .....			0.26	pF
Grid No.1 to Cathode, Heater, Grid No.2, and Grid No.3 .....			15	pF
Plate to Cathode, Heater, Grid No.2, and Grid No.3 .....			6.5	pF

▪ The dc component must not exceed 100 volts.

### Class A<sub>1</sub> Amplifier

CHARACTERISTICS:	Triode Connection		Pentode Connection	
	Plate Voltage .....	150		
Grid-No.2 Voltage .....	150	150	150	volts
Grid-No.1 Voltage .....	-22.5	0	-22.5	volts
Mu-Factor, grid No.2 to grid No.1 .....	4.4	—	—	
Plate Resistance (Approx.) .....	—	—	15000	ohms
Transconductance .....	—	—	7100	μmhos
Plate Current .....	—	390□	70	mA
Grid-No.2 Current .....	—	32□	2.1	mA
Grid-No.1 Voltage for plate current of 1 mA ..	—	—	-42	volts

□ This value can be measured by a method involving a recurrent waveform such that the maximum ratings of the tube will not be exceeded.

### Horizontal-Deflection Amplifier

For operation in a 525-line, 30-frame system

#### MAXIMUM RATINGS (Design-Maximum Values):

DC Plate Supply Voltage .....	770 max	volts
Peak Positive-Pulse Plate Voltage* .....	6500 max	volts
Peak Negative-Pulse Plate Voltage .....	-1500 max	volts
DC Grid-No.2 Voltage .....	220 max	volts
DC Grid-No.1 Voltage .....	-55 max	volts
Peak Negative-Pulse Grid-No.1 Voltage .....	-330 max	volts
Peak Cathode Current .....	550 max	mA
Average Cathode Current .....	175 max	mA
Plate Dissipation* .....	17.5 max	watts
Grid-No.2 Input .....	3.5 max	watts
Bulb Temperature (at hottest point) .....	240 max	°C

#### MAXIMUM CIRCUIT VALUES:

Grid-No.1-Circuit Resistance:

For grid-resistor-bias operation\* .....

1 max megohm

\* The duration of the voltage pulse must not exceed 15 per cent of one horizontal scanning cycle. In a 525-line, 30-frame system, 15 per cent of one horizontal scanning cycle is 10 microseconds.

• An adequate bias resistor or other means is required to protect the tube in the absence of excitation.

### MEDIUM-MU TRIODE— SHARP-CUTOFF PENTODE

Miniature type used as combined oscillator and mixer tube in television receivers utilizing an intermediate frequency in the order of 40 megacycles per second. Outline 6J, Outlines section.

**6GJ7**

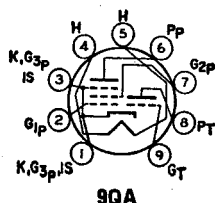

9QA

Tube requires miniature nine-contact socket and may be mounted in any position. Heater volts (ac/dc), 6.3; amperes, 0.41; peak heater-cathode volts, 110.

Class A<sub>1</sub> Amplifier

MAXIMUM RATINGS (Design-Maximum Values):	Triode Unit	Pentode Unit	
Plate-Supply Voltage .....	600 max	600 max	volts
DC Plate Voltage .....	140 max	275 max	volts
Grid-No.2 (Screen-Grid) Supply Voltage .....	—	600 max	volts
DC Grid-No.2 Voltage .....	—	275 max	volts
DC Grid-No.1 (Control-Grid) Voltage .....	—	-50 max	volts
Cathode Current .....	22 max	20 max	mA
Plate Dissipation .....	1.8 max	2.4 max	watts
Grid-No.2 Input .....	—	0.55 max	watt

## CHARACTERISTICS:

DC Plate Voltage .....	100	170	volts
DC Grid-No.2 Voltage .....	—	120	volts
DC Grid-No.1 Voltage .....	-3	-1.2	volts
Amplification Factor .....	20	55*	
Plate Resistance (Approx.) .....	—	0.35	megohm
Transconductance .....	9000	11000	μmhos
Grid-No.1 Voltage for grid-No.1 current of 0.3 μA .....	-1.3 max	-1.3 max	volts
Plate Current .....	15	10	mA
Grid-No.2 Current .....	—	3	mA

## MAXIMUM CIRCUIT VALUES:

Grid-No.1-Circuit Resistance:			
For fixed-bias operation .....	0.5 max	1 max	megohm
For cathode-bias operation .....	0.5 max	2.2 max	megohms

\* Grid No.2 to grid No.1.

## HIGH-MU TRIODE

## 6GK5

Related types:  
2GK5, 3GK5, 4GK5

Miniature type with frame grid used as grounded-cathode rf-amplifier tube in vhf tuners of television receivers. Outline 5C, Outlines section. Tube requires miniature seven-contact socket and may be operated in any position.

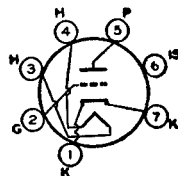

7FP

Types 2GK5, 3GK5, and 4GK5 are identical with type 6GK5 except for the heater ratings, as shown below.

	2GK5	3GK5	4GK5	6GK5	
Heater Voltage (ac/dc) .....	2.3	2.8	4.0	6.3	volts
Heater Current .....	0.6	0.45	0.3	0.18	ampere
Heater Warm-up Time (Average) .....	11	11	11	—	seconds

## Peak Heater-Cathode Voltage:

Heater negative with respect to cathode .....	100 max	100 max	100 max	100 max	volts
Heater positive with respect to cathode .....	100 max	100 max	100 max	100 max	volts

## Direct Interelectrode Capacitances (Approx.):\*

Grid to Plate .....	0.52	pF
Grid to Cathode, Heater, and Internal Shield .....	5	pF
Plate to Cathode, Heater, and Internal Shield .....	3.5	pF
Heater to Cathode .....	2.5*	pF

\* With external shield connected to cathode, except as noted.

\* With external shield and internal shield connected to ground.

Class A<sub>1</sub> Amplifier

MAXIMUM RATINGS (Design-Maximum Values):		
Plate Voltage .....	200 max	volts
Grid Voltage:		
Negative-bias value .....	-50 max	volts
Positive-bias value .....	0 max	volts
Average Cathode Current .....	22 max	mA
Plate Dissipation .....	2.5 max	watts

**CHARACTERISTICS:**

Plate Voltage .....	135	volts
Grid Voltage .....	-1	volts
Amplification Factor .....	78	
Plate Resistance (Approx.) .....	5400	ohms
Transconductance .....	15000	$\mu$ mhos
Plate Current .....	11.5	mA
Grid Voltage (Approx.) for transconductance of 150 $\mu$ mhos .....	-4.2	volts
Grid Voltage (Approx.) for transconductance of 1500 $\mu$ mhos .....	-2.5	volts
Input Resistance* .....	275	ohms
Input Capacitance* .....	11.2	pF
Noise Figure $\square$ .....	4.7	dB

**MAXIMUM CIRCUIT VALUES:**

Grid-Circuit Resistance: For cathode-bias operation ..... 1 max megohm

- Measured at 200 Mc/s with heater volts = 6.3 and plate effectively grounded for rf voltages.
- $\square$  For a neutralized triode amplifier at a frequency of 200 Mc/s with signal source impedance adjusted for minimum noise output.

AVERAGE PLATE CHARACTERISTICS

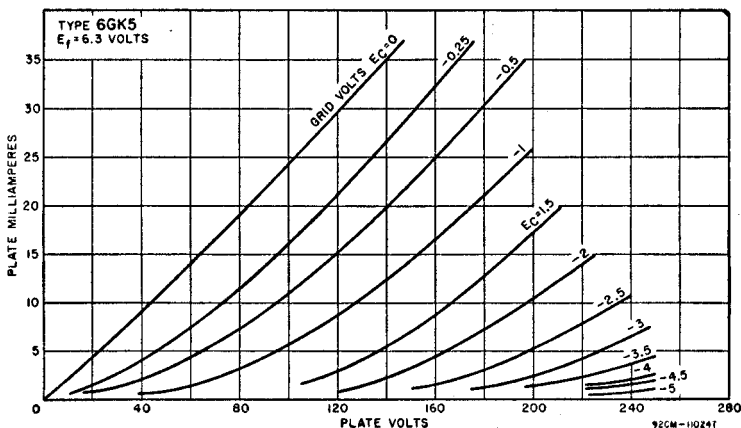

**POWER PENTODE**

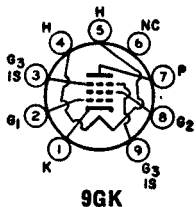

Miniature type used in the output stage of audio amplifying equipment and also in the video output stage of television receivers. Outline 6G, Outlines section. Tube requires miniature nine-contact socket and may be operated in any position.

**6GK6**  
Related type:  
16GK6

Heater Voltage (ac/dc) .....	6GK6 6.3	16GK6 16	volts
Heater Current .....	0.76	0.3	ampere
Heater Warm-up Time (Average) .....	—	11	seconds
Peak Heater-Cathode Voltage:			
Heater negative with respect to cathode .....	100 max	100 max	volts
Heater positive with respect to cathode .....	100 max	100 max	volts
Direct Interelectrode Capacitances:			
Grid No.1 to Plate .....		0.14 max	pF
Grid No.1 to Cathode, Heater, Grid No.2, Grid No.3, and Internal Shield .....		10	pF
Plate to Cathode, Heater, Grid No.2, Grid No.3, and Internal Shield .....		7	pF

Class A<sub>1</sub> Amplifier

## MAXIMUM RATINGS (Design-Maximum Values):

Plate Supply Voltage	600 max	volts
Plate Voltage	330 max	volts
Grid-No.2 Supply Voltage	605 max	volts
Grid-No.2 (Screen-Grid) Voltage	330 max	volts
Grid-No.1 (Control-Grid) Voltage, Negative-bias value	-100 max	volts
Cathode Current	65 max	mA
Plate Dissipation	13.2 max	watts
Grid-No.2 Input, Peak	4 max	watts
Grid-No.2 Input, Average	2 max	watts

## CHARACTERISTICS AND TYPICAL OPERATION:

Plate Supply Voltage	250	volts
Grid-No.2 Supply Voltage	250	volts
Cathode-Bias Resistor	135	ohms
Mu-Factor, Grid No.2 to Grid No.1	19	
Plate Resistance (Approx.)	38000	ohms
Transconductance	11300	$\mu$ mhos
Peak AF Grid-No.1 Voltage	7.3	volts
Zero-Signal Plate Current	48	mA
Maximum-Signal Plate Current	50.6	mA
Zero-Signal Grid-No.2 Current	5.5	mA
Maximum-Signal Grid-No.2 Current	10	mA
Effective Load Resistance	5200	ohms
Total Harmonic Distortion	10	per cent
Maximum-Signal Power Output	5.7	watts

## AVERAGE CHARACTERISTICS

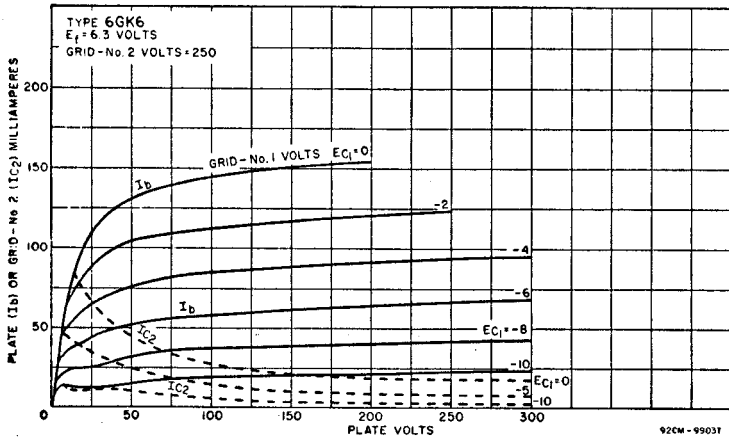
Push-Pull Class AB<sub>1</sub> and B AmplifierMAXIMUM RATINGS: (Same as for class A<sub>1</sub> amplifier)

## TYPICAL OPERATION,

(Values are for two tubes):

	Class AB <sub>1</sub>		Class B		
	250	300	250	300	
Plate Voltage	250	300	250	300	volts
Grid-No.2 Voltage	250	300	250	300	volts
Grid-No.1 Voltage	11	17	11	-14.7	volts
Cathode-Bias Resistor	—	—	-11.6	—	ohms
Peak AF Grid-No.1-to-Grid-No.1 Voltage	130	130	—	28	volts
Zero-Signal Plate Current	22.4	28	22.4	15	mA
Maximum-Signal Plate Current	62	72	20	92	mA
Zero-Signal Grid-No.2 Current	75	92	75	1.6	mA
Maximum-Signal Grid-No.2 Current	7	8	2.2	22	mA
Effective Load Resistance (plate to plate)	15	22	15	8000	ohms
Total Harmonic Distortion	8000	8000	8000	4	per cent
Maximum-Signal Power Output	3	4	3	17	watts



**MAXIMUM CIRCUIT VALUES:**

Grid-No.1-Circuit Resistance:

For fixed-bias operation .....	0.3 max megohm
For cathode-bias operation .....	1 max megohm

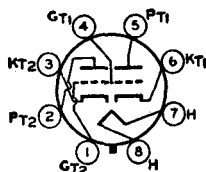

**8BD**

**DUAL TRIODE**

Glass type containing high-mu triode and high-perveance, low-mu triode in same envelope. Used as combined vertical-deflection-oscillator and vertical-deflection-amplifier tube in television receivers. Outline 13B, **Outlines** section.

**6GL7**

Tube requires octal socket and may be mounted in any position. Heater volts (ac/dc), 6.3; amperes, 1.05; peak heater-cathode volts, 200 (the dc component must not exceed 100 volts when the heater is positive with respect to the cathode).

**Class A<sub>1</sub> Amplifier**

**CHARACTERISTICS:**

	Unit No.1	Unit No.2	
Plate Voltage .....	250	175	volts
Grid Voltage .....	-3	-25	volts
Amplification Factor .....	66	5	
Plate Resistance (Approx.) .....	30000	780	ohms
Transconductance .....	2200	6400	μmhos
Grid Voltage (Approx.):			
For plate current of 20 μA .....	-5.3	-	volts
For plate current of 200 μA .....	-	-60	volts
Plate Current .....	2	46	mA

**Vertical-Deflection Oscillator and Amplifier**

For operation in a 525-line, 30-frame system

	Unit No.1 Oscillator	Unit No.2 Amplifier	
<b>MAXIMUM RATINGS (Design-Maximum Values):</b>			
DC Plate Voltage .....	350 max	550 max	volts
Peak Positive-Pulse Plate Voltage .....	-	1500 <sup>□</sup> max	volts
Peak Negative-Pulse Grid Voltage .....	-400 max	-250 max	volts
Peak Cathode Current .....	-	175 max	mA
Average Cathode Current .....	-	50 max	mA
Plate Dissipation* .....	1 max	10 max	watts

**MAXIMUM CIRCUIT VALUES:**

Grid-Circuit Resistance:

For fixed-bias operation .....	1 max	1 max megohm
For cathode-bias operation .....	2.2 max	2.2 max megohms

□ The duration of the voltage pulse must not exceed 15 per cent of one vertical scanning cycle. In a 525-line, 30-frame system, 15 per cent of one vertical scanning cycle is 2.5 milliseconds.

\* An adequate bias resistor or other means is required to protect the tube in the absence of excitation.

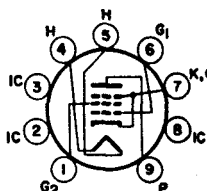

**9MQ**

**POWER PENTODE**

Neonoval type used as power amplifier in radio receivers and audio amplifiers. Outline 10D, **Outlines** section. Tube requires neonoval nine-contact socket and may be mounted in any position. Heater volts (ac/dc),

**6GM5**

6.3; amperes, 0.8; peak heater-cathode volts, 200 max (the dc component must not exceed 100 volts when the heater is positive with respect to the cathode).

**Class A<sub>1</sub> Amplifier**

**MAXIMUM RATINGS (Design-Maximum Values):**

Plate Voltage .....	550 max	volts
Grid-No.2 (Screen-Grid) Voltage .....	440 max	volts
Cathode Current .....	85 max	mA
Plate Dissipation .....	19 max	watts
Grid-No.2 Input .....	3.3*max	watts

**TYPICAL OPERATION AND CHARACTERISTICS:**

Plate Voltage .....	300	volts
Grid-No.2 Voltage .....	300	volts
Grid-No.1 (Control-Grid) Voltage .....	-10	volts
Peak AF Grid-No.1 Voltage .....	10	volts
Zero-Signal Plate Current .....	60	mA
Maximum-Signal Plate Current .....	75	mA
Zero-Signal Grid-No.2 Current .....	8	mA
Maximum-Signal Grid-No.2 Current .....	15	mA
Plate Resistance (Approx.) .....	29000	ohms
Transconductance .....	10200	μmhos
Load Resistance .....	3000	ohms
Total Harmonic Distortion .....	13	per cent
Maximum-Signal Power Output .....	11	watts

\* Grid-No.2 input may reach 6 watts during peak levels of speech and music signals.

**SEMIREMOTE-CUTOFF PENTODE**

**6GM6**

Related types:  
4GM6, 5GM6

Miniature type used in gain-controlled picture-if stages of television receivers operating at intermediate frequencies in the order of 40 megacycles. Tube features high transconductance and relatively low capacitances. Outline

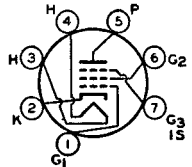

**7CM**

5C, Outlines section. Tube requires seven-contact socket and may be mounted in any position. Types 4GM6 and 5GM6 are identical with type 6GM6 except for the heater ratings, as shown below.

	4GM6	5GM6	6GM6	
Heater Voltage (ac/dc) .....	4.2	5.6	6.3	volts
Heater Current .....	0.6	0.45	0.4	ampere
Heater Warm-up Time (Average) .....	11	11	—	seconds
Peak Heater-Cathode Voltage:				
Heater negative with respect to cathode ...	200 max	200 max	200 max	volts
Heater positive with respect to cathode ...	200*max	200*max	200*max	volts
Direct Interelectrode Capacitances:				
Grid No.1 to Plate .....		0.036 max	0.026 max	pF
Grid No.1 to Cathode, Heater, Grid No.2, Grid No.3, and Internal Shield .....		10	10	pF
Plate to Cathode, Heater, Grid No.2, Grid No.3, and Internal Shield .....		2.4	3.4	pF

\* The dc component must not exceed 100 volts.

° With external shield connected to cathode.

**Class A<sub>1</sub> Amplifier**

**MAXIMUM RATINGS (Design-Maximum Values):**

Plate Voltage .....	330 max	volts
Grid-No.3 (Suppressor-Grid) Voltage, Positive value .....	0 max	volts
Grid-No.2 (Screen-Grid) Supply Voltage .....	330 max	volts
Grid-No.2 Voltage .....	See curve	page 80
Grid-No.1 (Control-Grid) Voltage, Positive-bias value .....	0 max	volts
Plate Dissipation .....	3.1 max	watts
Grid-No.2 Input:		
For grid-No.2 voltages up to 165 volts .....	0.65 max	watt
For grid-No.2 voltages between 165 and 330 volts .....	See curve	page 80

**CHARACTERISTICS:**

Plate Supply Voltage .....	125	volts
Grid-No.3 .....	Connected to cathode at socket	
Grid-No.2 Supply Voltage .....	125	volts
Cathode-Bias Resistor .....	56	ohms
Plate Resistance (Approx.) .....	0.2	megohm
Transconductance .....	13000	$\mu$ mhos
Grid-No.1 Voltage (Approx.) for transconductance of 60 $\mu$ mhos .....	-15	volts
Plate Current .....	14	mA
Grid-No.2 Current .....	3.4	mA

**AVERAGE CHARACTERISTICS**

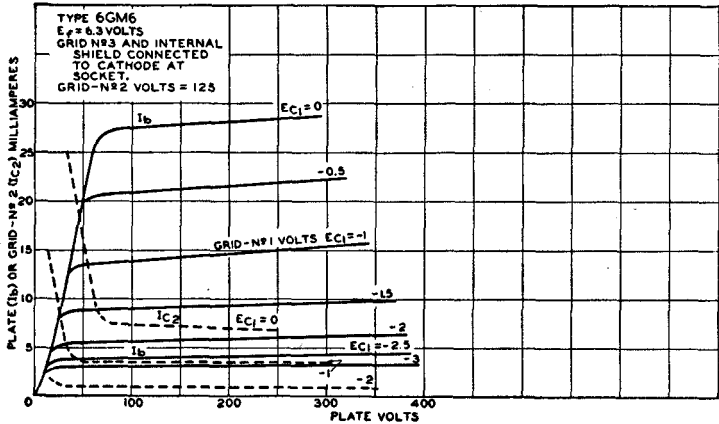

92CM-10390T1

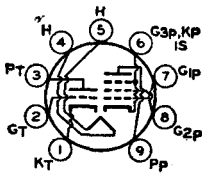

9DX

**HIGH-MU TRIODE—  
SHARP-CUTOFF PENTODE**

Miniature type used in color and black-and-white television receivers. Triode unit is used as sync-separator, sync-clipper, phase inverter, or sound-if amplifier. Pentode unit is used in output stage of video amplifier. Out-

**6GN8**

Related types:  
8GN8, 10GN8

line 6E, **Outlines** section. Tube requires miniature nine-contact socket and may be operated in any position. For direct interelectrode capacitances, refer to type 6EB8; curve for average plate characteristics of triode unit is same as for type 6EB8. Types 8GN8 and 10GN8 are identical with type 6GN8 except for the heater ratings, as shown below.

Heater Voltage (ac/dc) .....	6GN8	8GN8	10GN8	
	6.3	8	10.5	volts
Heater Current .....	0.75	0.6	0.45	ampere
	6GN8	8GN8	10GN8	
Heater Warm-up Time (Average) .....	—	11	11	seconds
Peak Heater-Cathode Voltage:				
Heater negative with respect to cathode ..	200 max	200 max	200 max	volts
Heater positive with respect to cathode ..	200*max	200*max	200*max	volts

\* The dc component must not exceed 100 volts.

**Class A<sub>1</sub> Amplifier**

**MAXIMUM RATINGS (Design-Maximum Values):**

Plate Voltage .....	330 max
Grid-No.2 (Screen-Grid) Supply Voltage .....	—
Grid-No.2 Voltage .....	—
Grid-No.1 (Control-Grid) Voltage, Positive-bias value .....	0 max

Triode Unit	Pentode Unit	
330 max	330 max	volts
—	330 max	volts
—	See curve page 80	
0 max	0 max	volt

Plate Dissipation .....	1 max	5 max	watts
Grid-No.2 Input:			
For grid-No.2 voltages up to 165 volts .....	—	1.1 max	watts
For grid-No.2 voltages between 165 and 330 volts .....	—	See curve page 80	

**CHARACTERISTICS:**

	Triode Unit	Pentode Unit		
Plate Supply Voltage .....	250	60	200	volts
Grid-No.2 Supply Voltage .....	—	150	150	volts
Grid-No.1 Voltage .....	-2	0	—	volts
Cathode-Bias Resistor .....	—	—	100	ohms
Amplification Factor .....	100	—	—	
Plate Resistance (Approx.) .....	37000	—	60000	ohms
Transconductance .....	2700	—	11500	$\mu$ mhos
Grid Voltage (Approx.) for plate current of 20 $\mu$ A .....	-5	—	—	volts
Grid-No.1 Voltage (Approx.) for plate current of 100 $\mu$ A .....	—	—	-10	volts
Plate Current .....	2	55*	25	mA
Grid-No.2 Current .....	—	18*	5.5	mA

**MAXIMUM CIRCUIT VALUES:**

	Triode Unit	Pentode Unit	
Grid-No.1-Circuit Resistance:			
For fixed-bias operation .....	0.5 max	0.25 max	megohm
For cathode-bias operation .....	1 max	1 max	megohm

\* This value can be measured by a method involving a recurrent waveform such that the maximum ratings of the tube will not be exceeded.

AVERAGE CHARACTERISTICS

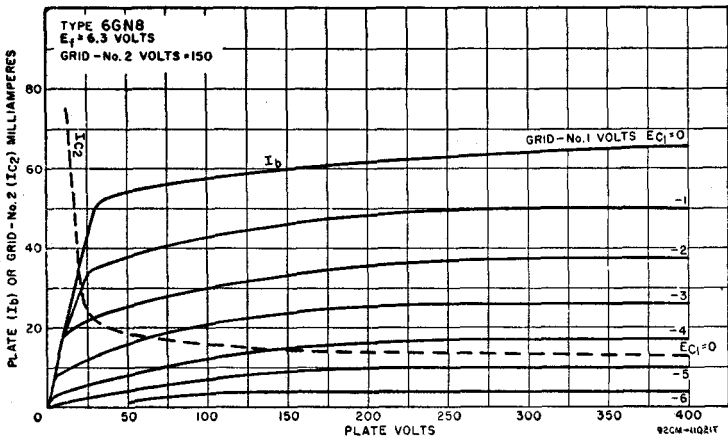

**6GT5  
6GT5A**

Related types:  
12GT5, 12GT5A,  
17GT5, 17GT5A

**BEAM POWER TUBE**

Novar types used as horizontal-deflection amplifiers in television receivers. Outlines 17B and 31A, respectively, Outlines section. Tubes require novar nine-contact socket and may be mounted in any position. For curve

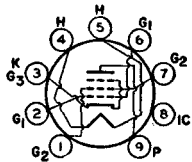

**9NZ**

of average characteristics, refer to type 6GW6. Types 12GT5 and 12GT5A and types 17GT5 and 17GT5A are identical with types 6GT5 and 6GT5A except for the heater ratings, as shown below.

	6GT5 6GT5A	12GT5 12GT5A	17GT5 17GT5A	
Heater Voltage (ac/dc) .....	6.3	12.6	16.8	volts
Heater Current .....	1.2	0.6	0.45	ampere
Heater Warm-up Time (Average) .....	—	11	11	seconds
Peak Heater-Cathode Voltage:				
Heater negative with respect to cathode ..	200 max	200 max	200 max	volts
Heater positive with respect to cathode ...	200□max	200□max	200□max	volts
Direct Interelectrode Capacitances (Approx.):				
Grid No.1 to Plate .....			0.26	pF
Grid No.1 to Cathode, Heater, Grid No.2, and Grid No.3 .....			15	pF
Plate to Cathode, Heater, Grid No.2, and Grid No.3 .....			6.5	pF

□ The dc component must not exceed 100 volts.

### Class A<sub>1</sub> Amplifier

CHARACTERISTICS:	Triode		Pentode		
	Connection		Connection		
Plate Voltage .....	150	60	250	—	volts
Grid-No.2 (Screen-Grid) Voltage .....	150	150	150	—	volts
Grid-No.1 (Control-Grid) Voltage .....	-22.5	0	-22.5	—	volts
Mu Factor, grid No.2 to grid No.1 .....	4.4	—	—	—	
Plate Resistance (Approx.) .....	—	—	15000	—	ohms
Transconductance .....	—	—	7100	—	μmhos
Plate Current .....	—	390*	70	—	mA
Grid-No.2 Current .....	—	32*	2.1	—	mA
Grid-No.1 Voltage (Approx.) for plate mA = 1 .....	—	—	-42	—	volts

\* These values can be measured by a method involving a recurrent waveform such that the plate dissipation and grid-No.2 input will not exceed their maximum ratings.

### Horizontal-Deflection Amplifier

For operation in a 525-line, 30-frame system

#### MAXIMUM RATINGS (Design-Maximum Values):

DC Plate Supply Voltage .....	770 max	volts
Peak Positive-Pulse Plate Voltage* .....	6500 max	volts
Peak Negative-Pulse Plate Voltage .....	-1500 max	volts
DC Grid-No.2 Voltage .....	220 max	volts
DC Grid-No.1 Voltage .....	-55 max	volts
Peak Negative-Pulse Grid-No.1 Voltage .....	-330 max	volts
Peak Cathode Current .....	550 max	mA
Average Cathode Current .....	175 max	mA
Grid-No.2 Input .....	3.5 max	watts
Plate Dissipation* .....	17.5 max	watts
Bulb Temperature (At hottest point) .....	240 max	°C

#### MAXIMUM CIRCUIT VALUES:

##### Grid-No.1-Circuit Resistance:

For grid-resistor-bias operation\* ..... 1 max megohm

\* The duration of the voltage pulse must not exceed 15 per cent of one horizontal scanning cycle. In a 525-line, 30-frame system, 15 per cent of one horizontal scanning cycle is 10 micro-seconds.

\* An adequate bias resistor or other means is required to protect the tube in the absence of excitation.

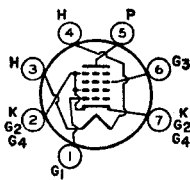

7GA

### BEAM HEXODE

Miniature type used as rf amplifier in vhf television receivers. Outline 5C, Outlines section. Tube requires miniature seven-contact socket and may be mounted in any position. Type 2GU5 is identical with type 6GU5 except for heater ratings, as shown below.

**6GU5**  
Related type:  
2GU5

	2GU5	6GU5	
Heater Voltage (ac/dc) .....	2.4	6.3	volts
Heater Current .....	0.6	0.22	ampere
Heater Warm-up Time (Average) .....	11	—	seconds

**Peak Heater-Cathode Voltage:**

Heater negative with respect to cathode .....	200 max	200 max	volts
Heater positive with respect to cathode .....	200*max	200*max	volts

**Direct Interelectrode Capacitances:**

Grid No.1 to Plate .....		0.018	pF
Grid No.1 to Cathode, Heater, Grid No.2, Grid No.3, and Grid No.4 .....		7	pF
Plate to Cathode, Heater, Grid No.2, Grid No.3, and Grid No.4		3.2	pF

\* The dc component must not exceed 100 volts.

**Class A<sub>1</sub> Amplifier****MAXIMUM RATINGS (Design-Maximum Values):**

Plate Voltage .....		300 max	volts
Grid-No.2 (Screen-Grid) Voltage .....		150 max	volts
DC Grid-No.1 (Control-Grid) Voltage:			
Positive bias value .....		0 max	volts
Negative-bias value .....		-50 max	volts
DC Cathode Current .....		20 max	mA
Plate Dissipation .....		3 max	watts
Grid-No.2 Input .....		0.5 max	megohm

**CHARACTERISTICS:**

Plate Voltage .....	135	275	volts
Grid-No.2 Voltage .....	135	135	volts
Grid-No.1 Voltage .....	-0.4	-0.4	volts
Grid No.3 .....		Connected to cathode at socket	
Plate Resistance (Approx.) .....	0.67	0.165	megohms
Transconductance .....	15000	15500	μmhos
Plate Current .....	9	10	mA
Grid-No.2 Current .....	0.25	0.17	mA
Grid-No.1 Voltage (Approx.) for transconductance of 100 μmhos .....	-6.2	-6.5	volts

**MAXIMUM CIRCUIT VALUE:**

Grid-No.1-Circuit Resistance:	0.5 max	megohm
-------------------------------	---------	--------

**MEDIUM-MU TWIN TRIODE****6GU7**

Miniature type used in the matrixing circuits of color television receivers employing series-connected heater strings. Also used in phase-inverter, multivibrator, and general purpose amplifier applications. Outline 6E,

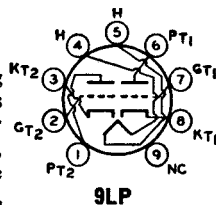

**Outlines section.** Tube requires miniature nine-contact socket and may be mounted in any position.

Heater Voltage (ac/dc) .....		6.3	volts
Heater Current .....		0.6	ampere
Heater Warm-up Time (Average) .....		11	seconds
Peak Heater-Cathode Voltage:			
Heater negative with respect to cathode .....		200 max	volts
Heater positive with respect to cathode .....		200*max	volts
Direct Interelectrode Capacitances (Approx.):	Unit No.1	Unit No.2	
Grid to Plate .....	3	3	pF
Grid to Cathode and Heater .....	3.4	3.6	pF
Plate to Cathode and Heater .....	0.44	0.34	pF
Plate of Unit No.1 to Plate of Unit No.2 .....			1 pF

\* The dc component must not exceed 100 volts.

**Class A<sub>1</sub> Amplifier (Each Unit)****MAXIMUM RATINGS (Design-Maximum Values):**

Plate Voltage .....		330 max	volts
Grid Voltage, Positive-bias value .....		0 max	volts
Plate Dissipation .....		3 max	watts

**CHARACTERISTICS:**

Plate Voltage .....		250	volts
Grid Voltage .....		-10.5	volts

Amplification Factor .....	17	
Plate Resistance (Approx.) .....	5500	ohms
Transconductance .....	3100	$\mu$ hos
Grid Voltage (Approx.) for plate current of 50 $\mu$ A .....	-23	volts
Plate Current .....	11.5	mA
Plate Current for grid voltage of -14 volts .....	4	mA

**MAXIMUM CIRCUIT VALUES:**

Grid-Circuit Resistance:	
For fixed-bias operation .....	1 max megohm

AVERAGE PLATE CHARACTERISTICS  
EACH UNIT

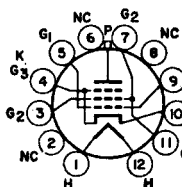
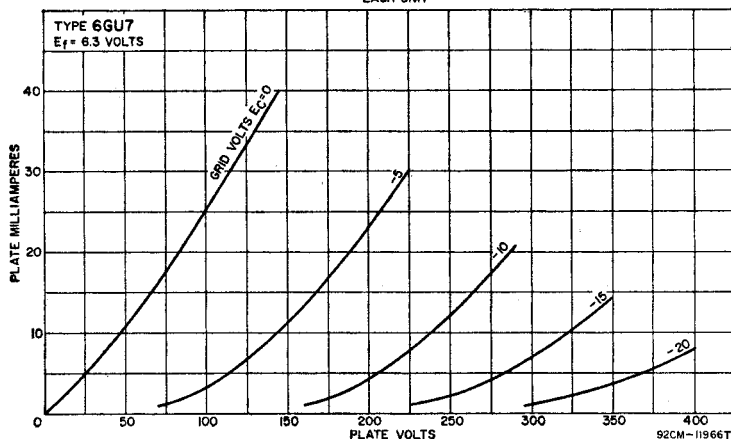

12DR

**BEAM POWER TUBE**

Duodecar type used as horizontal-deflection amplifier in television receivers. Outline 16A, Outlines section. Tube requires duodecar twelve-contact socket and may be mounted in any position. Type 17GV5 is identical

**6GV5**

Related type:  
17GV5

with type 6GV5 except for the heater ratings, as shown below.

	6GV5	17GV5	
Heater Voltage (ac/dc) .....	6.3	16.8	volts
Heater Current .....	1.2	0.45	ampere
Heater Warm-up Time (Average) .....	—	11	seconds
Peak Heater-Cathode Voltage:			
Heater negative with respect to cathode .....	200 max	200 max	volts
Heater positive with respect to cathode .....	200*max	200*max	volts

\* The dc component must not exceed 100 volts.

**Class A<sub>1</sub> Amplifier**

CHARACTERISTICS:	5000	60	250	volts
Plate Voltage .....	5000	60	250	volts
Grid-No.2 (Screen-Grid) Voltage .....	150	150	150	volts
Grid-No.1 (Control-Grid) Voltage .....	—	0	-22.5	volts
Plate Resistance (Approx.) .....	—	—	18000	ohms
Transconductance .....	—	—	7300	$\mu$ hos
Triode Amplification Factor .....	—	—	4.4*	
Plate Current .....	—	345*	65	mA
Grid-No.2 Current .....	—	27*	1.8	mA
Grid-No.1 Voltage (Approx.) for plate current of 1 mA .....	-100	—	-42	volts

\* Grid No.2 tied to plate; plate and grid-No.2 volts, 150; grid-No.1 volts, -22.5.  
 \* This value can be measured by a method involving a recurrent waveform such that the maximum ratings of the tube will not be exceeded.

### Horizontal-Deflection Amplifier

For operation in a 525-line, 30-frame system

#### MAXIMUM RATINGS (Design-Maximum Values):

DC Plate Supply Voltage	770 max	volts
Peak Positive-Pulse Plate Voltage*	6500 max	volts
Peak Negative-Pulse Plate Voltage	-1500 max	volts
DC Grid-No.2 Voltage	220 max	volts
Peak Negative-Pulse Grid-No.1 Voltage	-330 max	volts
DC Grid-No.1 Voltage	-55 max	volts
Peak Cathode Current	550 max	mA
Average Cathode Current	175 max	mA
Plate Dissipation†	17.5 max	watts
Grid-No.2 Input	3.5 max	watts
Bulb Temperature (At hottest point)	200 max	°C

#### MAXIMUM CIRCUIT VALUES:

Grid-No.1-Circuit Resistance ..... 1 max megohm

\* The duration of the voltage pulse must not exceed 15 per cent of one horizontal scanning cycle. In a 525-line, 30-frame system, 15 per cent of one horizontal scanning cycle is 10 microseconds.

† An adequate bias resistor or other means is required to protect the tube in the absence of excitation.

### HIGH-MU TRIODE— POWER PENTODE

## 6GV8

Related type:  
9GV8

Miniature type used for sync-amplifier and video-output applications in television receivers. Outline 6G, **Outlines** section. Tube requires miniature nine-contact socket and may be mounted in any position. Type 9GV8

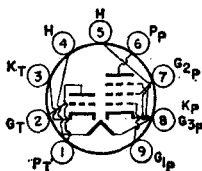

9LY

is identical with type 6GV8 except for the heater ratings, as shown below.

	6GV8	9GV8	
Heater Voltage (ac/dc)	6.3	9.5	volts
Heater Current	0.9	0.6	ampere
Peak Heater-Cathode Voltage:			
Heater negative with respect to cathode	220 max	220 max	volts
Heater positive with respect to cathode	220 max	220 max	volts

#### Class A<sub>1</sub> Amplifier

#### MAXIMUM RATINGS (Absolute-Maximum Values):

	Triode Unit	Pentode Unit	
Plate Supply Voltage	550 max	550 max	volts
Peak Plate Voltage*	—	2000 max	volts
DC Plate Voltage	250 max	250 max	volts
Grid-No.2 (Screen-Grid) Supply Voltage	—	550 max	volts
Grid-No.2 Voltage	—	250 max	volts
Peak Cathode Current*	200 max	—	mA
Average Cathode Current	15 max	75 max	mA
Grid-No.2 Input	—	2 max	watts
Plate Dissipation	0.5 max	7 max	watts

6AM

### BEAM POWER TUBE

## 6GW6

Related types:  
12GW6/12DQ6B,  
17GW6

Glass octal type used as horizontal-deflection amplifier in high-efficiency deflection circuits of television receivers. Outline 20, **Outlines** section. Tube requires octal socket and may be operated in any position. Types

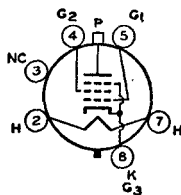

12GW6/12DQ6B and 17GW6 are identical with type 6GW6 except for the heater ratings, as shown below.

	6GW6	12GW6/ 12DQ6B	17GW6	
Heater Voltage (ac/dc)	6.3	12.6	16.8	volts
Heater Current	1.2	0.6	0.45	ampere
Heater Warm-up Time (Average)	—	11	11	seconds



Peak Heater-Cathode Voltage:

Heater negative with respect to cathode ..	200 max	200 max	200 max	volts
Heater positive with respect to cathode ..	200 <sup>□</sup> max	200 <sup>□</sup> max	200 <sup>□</sup> max	volts

Direct Interelectrode Capacitances (Approx.):

Grid No.1 to Plate .....	0.5	pF
Grid No.1 to Cathode, Heater, Grid No.2, and Grid No.3 .....	17	pF
Plate to Cathode, Heater, Grid No.2, and Grid No.3 .....	7	pF

□ The dc component must not exceed 100 volts.

Class A<sub>1</sub> Amplifier

CHARACTERISTICS:

Plate Voltage .....	60	250	volts
Grid-No.2 Voltage .....	150	150	volts
Grid-No.1 Voltage .....	0	-22.5	volts
Plate Resistance (Approx.) .....	—	15000	ohms
Transconductance .....	—	7100	μmhos
Plate Current .....	390*	70	mA
Grid-No.2 Current .....	32*	2.1	mA
Grid-No.1 Voltage (Approx.) for plate current of 1 mA .....	—	-42	volts

\* This value can be measured by a method involving a recurrent waveform such that the maximum ratings of the tube will not be exceeded.

Horizontal-Deflection Amplifier

For operation in a 525-line, 30-frame system

MAXIMUM RATINGS (Design-Maximum Values):

DC Plate Supply Voltage .....	770 max	volts
Peak Positive-Pulse Plate Voltage* .....	6500 max	volts
Peak Negative-Pulse Plate Voltage .....	-1500 max	volts
DC Grid-No.2 (Screen-Grid) Voltage .....	220 max	volts
DC Grid-No.1 (Control-Grid) Voltage .....	-55 max	volts
Peak Negative-Pulse Grid-No.1 Voltage .....	-330 max	volts
Peak Cathode Current .....	550 max	mA
Average Cathode Current .....	175 max	mA
Grid-No.2 Input .....	3.5 max	watts
Plate Dissipation* .....	17.5 max	watts
Bulb Temperature (At hottest point) .....	240 max	°C

MAXIMUM CIRCUIT VALUES:

Grid-No.1-Circuit Resistance: For grid resistor-bias operation ..... 1 max megohm

\* The duration of the voltage pulse must not exceed 15 per cent of one horizontal scanning cycle. In a 525-line, 30-frame system, 15 per cent of one horizontal scanning cycle is 10 microseconds.

• An adequate bias resistor or other means is required to protect the tube in the absence of excitation.

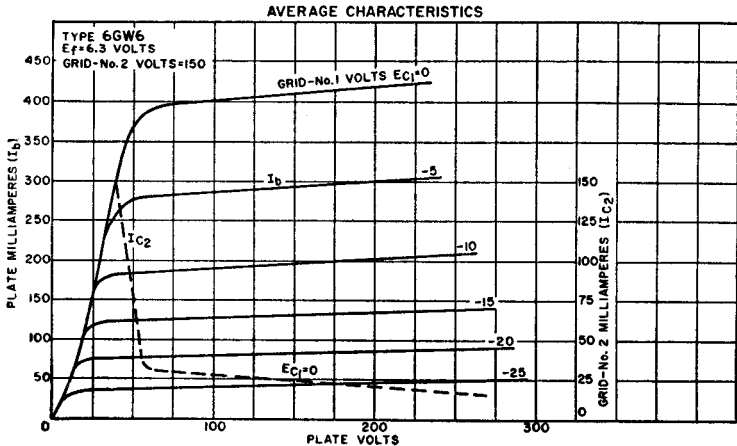

### HIGH-MU TRIODE— SHARP-CUTOFF PENTODE

**6GW8/  
ECL86**

Miniature type used in preamplifier and audio output stages of audio equipment and television receivers. Outline 6G, **Outlines** section. Tube requires miniature nine-contact socket and may be mounted in any position.

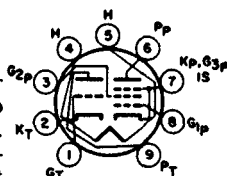

**B10**

Heater volts (ac/dc), 6.3; amperes, 0.7; peak heater-cathode volts, 100.

#### Class A<sub>1</sub> Amplifier

##### MAXIMUM RATINGS (Design-Center Values):

	Triode Unit	Pentode Unit	
Plate Supply Voltage	550 max	550 max	volts
Plate Voltage	300 max	300 max	volts
Grid-No.2 (Screen-Grid) Supply Voltage	—	550 max	volts
Grid-No.2 Voltage	—	300 max	volts
Grid-No.1 (Control-Grid) Voltage, Negative-bias value	-1.3 max	-1.3 max	volts
Cathode Current	55 max	8 max	mA
Plate Dissipation	0.5 max	9 max	watts
Grid-No.2 Input	—	1.5 max	watts

##### CHARACTERISTICS:

Plate Voltage	250	250	volts
Grid-No.2 Voltage	—	250	volts
Grid-No.1 Voltage	-1.7	-7	volts
Amplification Factor	100	21*	
Plate Resistance (Approx.)	—	45000	ohms
Transconductance	1600	10000	μmhos
Plate Current	1.2	36	mA
Grid-No.2 Current	—	5.5	mA

\* Grid No.2 to grid No.1.

### SHARP-CUTOFF PENTODE

**6GX6**

Related type:  
**5GX6**

Miniature type used for FM sound-detector service in locked-oscillator, quadrature-grid FM detector circuits, as combined detector, limiter, and audio-voltage driver. Tube has two independent control grids, and has

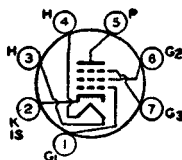

**7EN**

controlled heater warm-up time for use in circuits employing series-connected heater strings. Outline 5C, **Outlines** section. Tube requires miniature seven-contact socket and may be mounted in any position. Type 5GX6 is identical with type 6GX6 except for the heater ratings, as shown below.

	5GX6	6GX6	
Heater Voltage (ac/dc)	4.7	6.3	volts
Heater Current	0.6	0.45	ampere
Heater Warm-up Time (Average)	11	11	seconds
Peak Heater-Cathode Voltage:			
Heater negative with respect to cathode	200 max	200 max	volts
Heater positive with respect to cathode	200*max	200*max	volts
Direct Interelectrode Capacitances (Approx.):			
Grid No.1 to Plate		0.026	pF
Grid No.1 to Cathode, Heater, Grid No.2, Grid No.3, and Internal Shield		8	pF
Grid No.1 to Grid No.3		0.12	pF
Grid No.3 to Plate		1.6	pF
Grid No.3 to Cathode, Heater, Grid No.1, Grid No.2, Plate, and Internal Shield		6.5	pF

\* The dc component must not exceed 100 volts.

Class A<sub>1</sub> Amplifier

CHARACTERISTICS:

Plate Supply Voltage .....	150	volts
Grid-No.3 Supply Voltage .....	0	volts
Grid-No.2 Supply Voltage .....	100	volts
Grid-No.1 Supply Voltage .....	0	volts
Cathode-Bias Resistor .....	180	ohms
Plate Resistance (Approx.) .....	0.14	megohm
Transconductance, grid No.1 to plate .....	3700	$\mu$ mhos
Transconductance, grid No.3 to plate .....	750	$\mu$ mhos
Plate Current .....	3.7	mA
Grid-No.2 Current .....	3	mA
Grid-No.3 Supply Voltage (Approx.) for plate current of 20 $\mu$ A .....	-7	volts
Grid-No.1 Supply Voltage (Approx.) for plate current of 20 $\mu$ A .....	-4.5	volts

AVERAGE CHARACTERISTICS

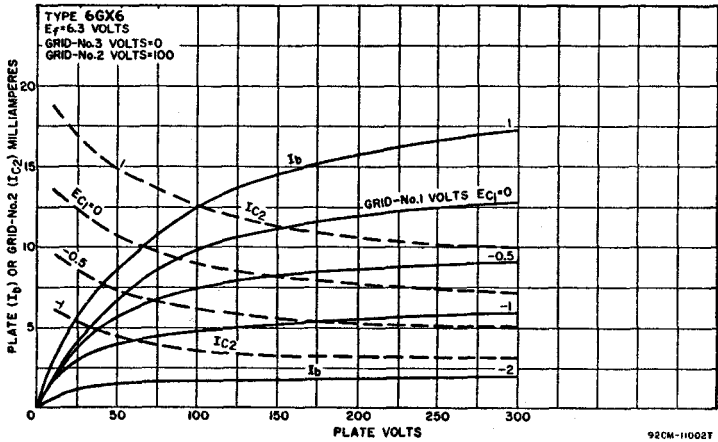

AVERAGE CHARACTERISTICS

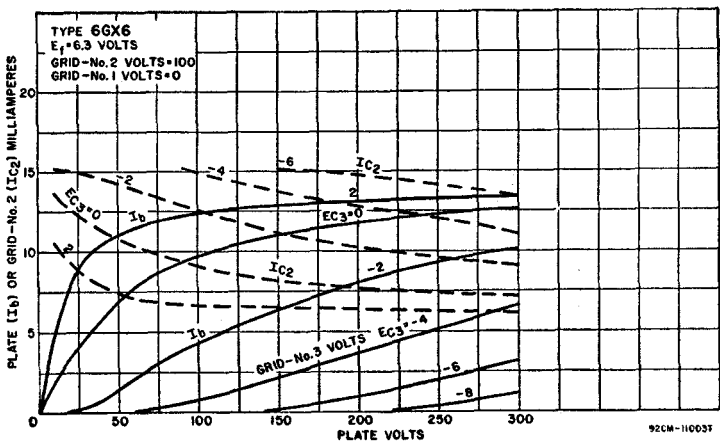

## FM Sound Detector

## MAXIMUM RATINGS (Design-Maximum Values):

Plate Voltage	300 max	volts
Grid-No.3 (Control-Grid) Voltage:		
Negative value (dc and peak ac)	-100 max	volts
Positive value (dc and peak ac)	25 max	volts
Grid-No.2 (Screen-Grid) Supply Voltage	300 max	volts
Grid-No.2 Voltage	See curve	page 80
Grid-No.1 (Control-Grid) Voltage:		
Negative-bias value	-50 max	volts
Positive-bias value	0 max	volts
Plate Dissipation	1.7 max	watts
Grid-No.3 Input	0.1 max	watt
Grid-No.2 Input:		
For grid-No.2 voltages up to 150 volts	1.0 max	watt
For grid-No.2 voltages between 150 and 300 volts	See curve	page 80
<b>MAXIMUM CIRCUIT VALUES:</b>		
Grid-No.3-Circuit Resistance	0.68 max	megohm
Grid-No.1-Circuit Resistance:		
For fixed-bias operation	0.22 max	megohm
For cathode-bias operation	0.47 max	megohm

MEDIUM-MU TRIODE—  
SHARP-CUTOFF PENTODE

## 6GX7

Related types:  
4GX7, 5GX7

Miniature type used as combined oscillator-mixer tube in vhf tuner circuits of television receivers. Outline 6B, Outlines section. Tube requires miniature nine-contact socket and may be mounted in any position.

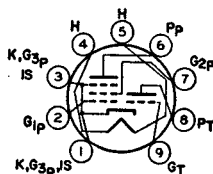

## 9QA

Types 4GX7 and 5GX7 are identical with type 6GX7 except for the heater ratings, as shown below.

	4GX7	5GX7	6GX7	
Heater Voltage (ac/dc)	4.2	5.6	6.3	volts
Heater Current	0.6	0.45	0.4	ampere
Heater Warm-up Time	11	11	—	
Peak Heater-Cathode Voltage:				
Heater negative with respect to cathode	200	200	200 max	volts
Heater positive with respect to cathode	200*	200*	200*max	volts
Direct Interelectrode Capacitances:**				
Triode Unit:				
Grid to Plate			1.2	pF
Grid to Cathode, Heater, Pentode Cathode, Grid No. 3, and Internal Shield			2.3	pF
Plate to Cathode, Heater, Pentode Cathode, Grid No. 3, and Internal Shield			1.9	pF
Pentode Unit:				
Grid No. 1 to Plate			0.005	pF
Grid No. 1 to Cathode, Heater, Grid No. 2, Grid No. 3, and Internal Shield			5.4	pF
Plate to Cathode, Heater, Grid No. 2, Grid No. 3, and Internal Shield			3.3	pF
Grid No. 1 to Grid No. 2			1.6	pF

\* The dc component must not exceed 100 volts.

\*\* With external shield connected to cathode.

Class A<sub>1</sub> Amplifier

## MAXIMUM RATINGS (Design-Maximum Values):

	Triode Unit	Pentode Unit	
Plate Voltage	275 max	275 max	volts
Grid-No.2 (Screen-Grid) Supply Voltage	—	275 max	volts
Grid-No.2 Voltage	—	See curve	page 80
Grid-No.1 (Control-Grid) Voltage:			
Positive-bias Value	0	0	
Negative-bias Value	-40	-40 max	volts
Cathode Current	20	20 max	mA
Plate Dissipation	1.5	2.2 max	watts
Grid-No.2 Input:			
For Grid-No.2 voltages up to 137.5 volts	—	0.45 max	watts
For Grid-No.2 voltages between 137.5 and 275 volts	—	See curve	page 80

**CHARACTERISTICS:**

Plate Voltage	100	125	120	125	volts
Grid-No.2 Voltage	—	—	90	125	volts
Grid-No.1 Voltage	—	—1	—	—1	volt
Grid-No.1-Circuit Resistance	0.1	—	0.1	—	megohm
Amplification Factor	40	—	—	—	
Plate Resistance	—	4700	—	20000	ohms
Transconductance	8700	8500	13000	11000	μmhos
Plate Current	12.5	13	8.5	8.0	mA
Grid-No.2 Current	—	—	2.8	2.5	mA
Grid-No.1 Voltage for plate current of 20 μA	—6	—	—2.5	—	volts

**MAXIMUM CIRCUIT VALUES:**

Grid-No.1-Circuit Resistance:					
For fixed-bias operation			0.5 max	0.25 max	megohm
For cathode-bias operation			1.0 max	0.5 max	megohm

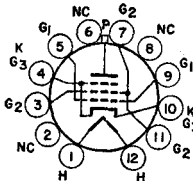

12DR

**BEAM POWER TUBE**

Duodecar type used as horizontal-deflection amplifier in television receivers. Outline 16A, Outlines section. Tube requires duodecar twelve-contact socket and may be mounted in any position. Type 21GY5 is identical with type 6GY5 except for the heater ratings, as shown below.

**6GY5**

Related type:  
21GY5

Heater Voltage (ac/dc)	6GY5	21GY5	
Heater Current	6.3	21	volts
Heater Warm-up Time (average)	1.5	0.45	amperes
Peak Heater-Cathode Voltage:		11	seconds
Heater negative with respect to cathode	200 max	200 max	volts
Heater positive with respect to cathode	200*max	200*max	volts

\* The dc component must not exceed 100 volts.

**Class A<sub>1</sub> Amplifier**

**CHARACTERISTICS:**

Plate Voltage	5000	60	130	volts
Grid-No.2 (Screen-Grid) Voltage	130	130	130	volts
Grid-No.1 (Control-Grid) Voltage	—	0	—20	volts
Plate Resistance (approx.)	—	—	11000	ohms
Transconductance	—	—	9100	μmhos
Plate Current	—	410**	50	mA
Grid-No.2 Current	—	24**	1.75	mA
Grid-No.1 Voltage (Approx.) for plate current of 1 μA	—66	—	—33	volts
Triode Amplification Factor†	—	—	4.7	

\*\* This value can be measured by a method involving a recurrent waveform such that the maximum ratings of the tube will not be exceeded.

† Triode connection (grid No.2 tied to plate).

**Horizontal-Deflection Amplifier**

For operation in a 525-line, 30-frame system

**MAXIMUM RATINGS (Design-Maximum Values):**

DC Plate Supply Voltage	770 max	volts
Peak Positive-Pulse Plate Voltage	6500 max	volts
Peak Negative-Pulse Plate Voltage	—1500 max	volts
DC Grid-No.2 Voltage	220 max	volts
DC Grid-No.1 Voltage	—55 max	volts
Peak Negative-Pulse Grid-No.1 Voltage	—330 max	volts
Peak Cathode Current	800 max	mA
Average Cathode Current	230 max	mA
Plate Dissipation††	18 max	watts
Grid-No.2 Input	3.5 max	watts
Bulb Temperature (At hottest point)	220 max	°C

**MAXIMUM CIRCUIT VALUES:**

Grid-No.1-Circuit Resistance .....	1 max megohm
------------------------------------	--------------

†† An adequate bias resistor or other means is required to protect the tube in the absence of excitation.

**SHARP-CUTOFF PENTODE****6GY6**

Miniature type used in gated-agc-amplifier circuits and as a noise-inverter tube in television receivers. Tube has two independent control grids, and has controlled heater warm-up time for use in circuits employing series-

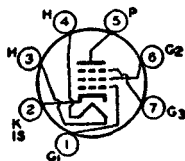
**7EN**

connected heater strings. Outline 5C, **Outlines** section. Tube requires miniature seven-contact socket and may be mounted in any position. For curves of average characteristics, refer to type 6GX6.

Heater Voltage (ac/dc) .....	6.3	volts
Heater Current .....	0.45	ampere
Heater Warm-up Time (Average) .....	11	seconds
<b>Peak Heater-Cathode Voltage:</b>		
Heater negative with respect to cathode .....	200 max	volts
Heater positive with respect to cathode .....	200*max	volts
<b>Direct Interelectrode Capacitances:</b>		
Grid No.1 to Plate .....	0.026	pF
Grid No.1 to Cathode, Heater, Grid No.2, Grid No.3, and Internal Shield .....	8	pF
Grid No.1 to Grid No.3 .....	0.12	pF
Grid No.3 to Plate .....	1.6	pF
Grid No.3 to Cathode, Heater, Plate, Grid No.1, Grid No.2, and Internal Shield .....	6.5	pF

- The dc component must not exceed 100 volts.

**Class A<sub>1</sub> Amplifier****CHARACTERISTICS:**

Plate Supply Voltage .....	150	volts
Grid-No.3 Supply Voltage .....	0	volts
Grid-No.2 Supply Voltage .....	100	volts
Grid-No.1 Supply Voltage .....	0	volts
Cathode-Bias Resistor .....	180	ohms
Plate Resistance (Approx.) .....	0.14	megohm
Transconductance, Grid No.1 to Plate .....	3700	μmhos
Transconductance, Grid No.3 to Plate .....	750	μmhos
Plate Current .....	3.7	mA
Grid-No.2 Current .....	3	mA
Grid-No.3 Supply Voltage (Approx.) for plate current of 20 μA .....	-7	volts
Grid-No.1 Supply Voltage (Approx.) for plate current of 20 μA .....	-4.5	volts

**Gated AGC Amplifier and Noise Inverter**

For operation in a 525-line, 30-frame system

**MAXIMUM RATINGS (Design-Maximum Values):**

Plate Voltage .....	300 max	volts
Peak Positive-Pulse Plate Voltage* .....	600 max	volts
<b>Grid-No.3 (Control-Grid) Voltage:</b>		
Negative-bias value .....	-100 max	volts
Positive-bias value .....	0 max	volts
Grid-No.2 (Screen-Grid) Supply Voltage .....	300 max	volts
Grid-No.2 Voltage .....	See curve	page 80
<b>Grid-No.1 (Control-Grid) Voltage:</b>		
Negative-bias value .....	-50 max	volts
Positive-bias value .....	0 max	volts
Plate Dissipation .....	1.7 max	watts
<b>Grid-No.2 Input:</b>		
For Grid-No.2 voltages up to 150 volts .....	1 max	watt
For Grid-No.2 voltages between 150 and 300 volts .....	See curve	page 80

**MAXIMUM CIRCUIT VALUES:**

Grid-No.3-Circuit Resistance .....	0.68 max	megohm
Grid-No.1-Circuit Resistance:		
For fixed-bias operation .....	0.22 max	megohm
For cathode-bias operation .....	0.47 max	megohm

▪ The duration of the voltage pulse must not exceed 15 per cent of one horizontal scanning cycle. In a 525-line, 30-frame system, 15 per cent of one horizontal scanning cycle is 10 microseconds.

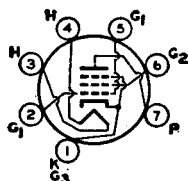

**7CV**

position. Type 4GZ5 is identical with type 6GZ5 except for the heater ratings, as shown below.

**POWER PENTODE**

Miniature type used in audio output stages of radio and television receivers employing series-connected heater strings. Outline 5C, **Outlines** section. Tube requires miniature seven-contact socket and may be mounted in any

**6GZ5**

Related type:  
**4GZ5**

Heater Voltage (ac/dc) .....	<b>4GZ5</b> 4	<b>6GZ5</b> 6.3	volts
Heater Current .....	0.6	0.38	ampere
Heater Warm-up Time (Average) .....	11	—	seconds
Peak Heater-Cathode Voltage:			
Heater negative with respect to cathode .....	200 max	200 max	volts
Heater positive with respect to cathode .....	200*max	200*max	volts

▪ The dc component must not exceed 100 volts.

**Class A<sub>1</sub> Amplifier**

**MAXIMUM RATINGS (Design-Maximum Values):**

Plate Voltage .....		300 max	volts
Grid-No.2 (Screen-Grid) Voltage .....		300 max	volts
Grid-No.1 (Control-Grid) Voltage, Positive-bias value .....		0 max	volts
Average Cathode Current .....		30 max	mA
Plate Dissipation .....		4.8 max	watts
Grid-No.2 Input .....		1.1 max	watts
Bulb temperature (At hottest point) .....		200 max	°C

**TYPICAL OPERATION:**

Plate Supply Voltage .....	250	250	volts
Grid-No.2 Supply Voltage .....	250	250	volts
Cathode-Bias Resistor .....	270	270*	ohms
Peak AF Grid-No.1 Voltage .....	9.8	2	volts
Zero-Signal Plate Current .....	16	16	mA
Maximum-Signal Plate Current .....	16	16	mA
Zero-Signal Grid-No.2 Current .....	2.7	2.7	mA
Maximum-Signal Grid-No.2 Current .....	5	5	mA
Plate Resistance (Approx.) .....	—	0.15	megohm
Transconductance .....	—	8400	μmhos
Load Resistance .....	15000	15000	ohms
Total Harmonic Distortion .....	10	10	per cent
Maximum-Signal Power Output .....	1.8	1.1	watts

**MAXIMUM CIRCUIT VALUES:**

Grid-No.1-Circuit Resistance:		
For fixed-bias operation .....	0.5 max	megohm
For cathode-bias operation .....	1 max	megohm

• Bypassed.

## TWIN DIODE

**6H6**Related types:  
12H6

Metal type used as detector, low-voltage rectifier, and avc tube. Except for the common heater, the two diode units are independent of each other. For diode detector considerations, refer to **Electron Tube Applications** section. Type 12H6 is identical with type 6H6 except for the heater ratings, as shown below.

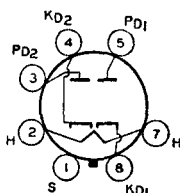

7Q

7Q

	6H6	12H6	
Heater Voltage (ac/dc) .....	6.3	12.6	volts
Heater Current .....	0.3	0.15	ampere
Peak Heater-Cathode Voltage:			
Heater negative with respect to cathode .....	330 max	330 max	volts
Heater positive with respect to cathode .....	330 max	330 max	volts

## Rectifier or Doubler

## MAXIMUM RATINGS:

Peak Inverse Plate Voltage .....		420 max	volts
Peak Plate Current (Per Plate) .....		48 max	mA
DC Output Current (Per Plate) .....		8 max	mA

## TYPICAL OPERATION AS HALF-WAVE

## RECTIFIER\*:

AC Plate Voltage (Per Plate, rms) .....	117	150	volts
Min. Total Effective Plate-Supply Impedance (Per Plate) <sup>o</sup> .....	15	40	ohms
DC Output Current (Per Plate) .....	8	8	mA

## TYPICAL OPERATION AS VOLTAGE DOUBLER:

	Half-Wave	Full-Wave	
AC Plate Voltage (Per Plate, rms) .....	117	117	volts
Min. Total Effective Plate-Supply Impedance (Per Plate) <sup>o</sup> .....	30	15	ohms
DC Output Current .....	8	8	mA

\* In half-wave service, the two units may be used separately or in parallel.

<sup>o</sup> When a filter-input capacitor larger than 40  $\mu$ F is used, it may be necessary to use more plate-supply impedance than the value shown to limit the peak plate current to the rated value.

## Installation and Application

Type 6H6 requires an octal socket and may be mounted in any position. Outline 29B, **Outlines** section.

For detection, the diodes may be utilized in a full-wave circuit or in a half-wave circuit. In the latter case, one plate only, or the two plates in parallel, may be employed. For the same signal voltage, the use of the half-wave arrangement will provide approximately twice the rectified voltage as compared with the full-wave arrangement.

For automatic volume control, the 6H6 may be used in circuits similar to those employed for any of the twin-diode types of tubes. The only difference is that the 6H6 is more adaptable because each diode has its own separate cathode.

## HIGH-MU TRIODE

**6HA5**Related types:  
2HA5, 3HA5, 4HA5

Miniature type used as rf-amplifier tube in vhf television tuners. Outline 5A, **Outlines** section. Tube requires miniature seven-contact socket and may be mounted in any position. Type 6HA5 and related type 3HA5

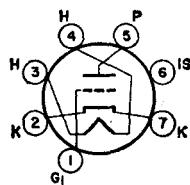

7GM



are electrically identical with types 6HM5/6HA5 and 3HM5/3HA5, respectively. Related types 2HA5 and 4HA5 are electrically identical with type 6HA5 except for heater voltages of 2.2 and 3.9 volts and heater currents of 0.6 and 0.3 ampere, respectively.

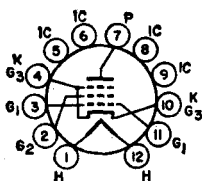

12BJ

### BEAM POWER TUBE

Duodecahedral type used as horizontal-deflection amplifier in television receivers. Outline 15B, **Outlines** section. Tube requires duodecahedral twelve-contact socket and may be mounted in any position. Type 21HB5 is identical

**6HB5**  
Related type:  
**21HB5**

with type 6HB5 except for the heater ratings, as shown below.

Heater Voltage (ac/dc) .....	6HB5 6.3	21HB5 21	volts
Heater Current .....	1.5	0.45	amperes
Heater Warm-up Time (Average) .....	—	11	seconds
Peak Heater-Cathode Voltage:			
Heater negative with respect to cathode .....	200 max	200 max	volts
Heater positive with respect to cathode .....	200*max	200*max	volts

\* The dc component must not exceed 100 volts.

### Class A<sub>1</sub> Amplifier

#### CHARACTERISTICS:

Plate Voltage .....	5000	60	130	volts
Grid-No.2 (Screen-Grid) Voltage .....	130	130	130	volts
Grid-No.1 (Control-Grid) Voltage .....	—	0	-20	volts
Triode Amplification Factor .....	—	—	4.7*	
Plate Resistance (Approx.) .....	—	—	11000	ohms
Transconductance .....	—	—	9100	μmhos
Plate Current .....	—	410*	50	mA
Grid-No.2 Current .....	—	24*	1.75	mA
Grid-No.1 Voltage (Approx.) for plate current of 1 mA .....	-66	—	-33	volts

\* Grid No.2 tied to plate; plate and grid-No.2 volts, 130; grid-No.1 volts, -20.

\* This value can be measured by a method involving a recurrent waveform such that the maximum ratings of the tube will not be exceeded.

### Horizontal-Deflection Amplifier

For operation in a 525-line, 30-frame system

#### MAXIMUM RATINGS (Design-Maximum Values):

DC Plate Supply Voltage .....	770 max	volts
Peak Positive-Pulse Plate Voltage# .....	6000 max	volts
Peak Negative-Pulse Plate Voltage .....	-1500 max	volts
DC Grid-No.2 Voltage .....	220 max	volts
DC Grid-No.1 Voltage .....	-55 max	volts
Peak Negative-Pulse Grid-No.1 Voltage .....	-330 max	volts
Peak Cathode Current .....	800 max	mA
Average Cathode Current .....	230 max	mA
Plate Dissipation† .....	18 max	watts
Grid-No.2 Input .....	3.5 max	watts
Bulb Temperature (At hottest point) .....	220 max	°C

#### MAXIMUM CIRCUIT VALUE:

Grid-No.1-Circuit Resistance .....	1 max	megohm
------------------------------------	-------	--------

# The duration of the voltage pulse must not exceed 15 per cent of one horizontal scanning cycle. In a 525-line, 30-frame system, 15 per cent of one horizontal scanning cycle is 10 microseconds.

† An adequate bias resistor or other means is required to protect the tube in the absence of excitation.

## POWER PENTODE

**6HB6**

Related type:  
15HB6

Miniature type used as vertical deflection-amplifier tube in television receivers. Outline 6G, Outlines section. Tube requires miniature nine-contact socket and may be mounted in any position. Type 15HB6 is identical with type 6HB6 except for the heater ratings, as shown below.

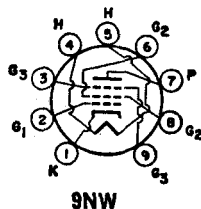

	6HB6	15HB6	
Heater Voltage (ac/dc) .....	6.3	14.7	volts
Heater Current .....	0.76	0.3	ampere
Heater Warm-up Time (Average) .....	—	11	seconds
Peak Heater-Cathode Voltage:			
Heater negative with respect to cathode .....	200 max	200 max	volts
Heater positive with respect to cathode .....	200*max	200*max	volts

\* The dc component must not exceed 100 volts.

## CHARACTERISTICS:

Plate Supply Voltage .....	60	250	250	volts
Grid No.3 .....			Connected to cathode at socket	
Grid-No.2 Supply Voltage .....	250	125	250	volts
Grid-No.1 Voltage .....	0	—	—	volts
Cathode-Bias Resistor .....	—	33	100	ohms
Mu-Factor, Grid No.2 to Grid No.1 .....	—	—	33	
Plate Resistance (Approx.) .....	—	28000	24000	ohms
Transconductance .....	—	24000	20000	$\mu$ mhos
Plate Current .....	150*	40	40	mA
Grid-No.2 Current .....	37*	4.2	6.2	mA
Grid-No.1 Voltage (Approx.) for plate current of 100 $\mu$ A .....	—	-6.4	-13	volts

\* This value can be measured by a method involving a recurrent waveform such that the maximum tube ratings will not be exceeded.

## Vertical-Deflection Amplifier

For operation in a 525-line, 30-frame system

## MAXIMUM RATINGS (Design-Maximum Values):

DC Plate Voltage .....	350 max	volts
Peak Positive-Pulse Plate Voltage* .....	2500 max	volts
DC Grid-No.2 (Screen-Grid) Voltage .....	300 max	volts
DC Grid-No.1 (Control-Grid) Voltage .....	-100 max	volts
Grid-No.2 Input .....	2 max	watts
Plate Dissipation .....	10 max	watts

## MAXIMUM CIRCUIT VALUES:

Grid-No.1-Circuit Resistance:		
For fixed-bias operation .....	1 max	megohm
For cathode-bias operation .....	2.2 max	megohms

\* The duration of the voltage pulse must not exceed 15 per cent of one vertical scanning cycle. In a 525-line, 30-frame system, 15 per cent of one vertical-scanning cycle is 2.5 milliseconds.

MEDIUM-MU TRIODE—  
SHARP-CUTOFF PENTODE**6HB7**

Related type:  
5HB7

Miniature type used as combined oscillator and mixer tube in television receivers utilizing an intermediate frequency in the order of 40 megacycles per second, and employing series-connected heater strings. Outline 6B,

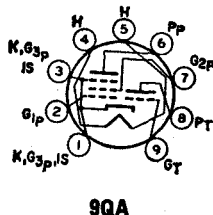

9QA

**Outlines section.** Tube requires miniature nine-contact socket and may be mounted in any position. Type 5HB7 is identical with type 6HB7 except for heater ratings, as shown below.

	<b>5HB7</b>	<b>6HB7</b>	
Heater Voltage (ac/dc) .....	4.7	6.3	volts
Heater Current .....	0.6	0.45	ampere
Heater Warm-up Time (Average) .....	11	11	seconds
<b>Peak Heater-Cathode Voltage:</b>			
Heater negative with respect to cathode .....		200 max	volts
Heater positive with respect to cathode .....		200*max	volts
<b>Direct Interelectrode Capacitances:△</b>			
<b>Triode Unit:</b>			
Grid to Plate .....		1.9	pF
Grid to Cathode, Heater, Pentode Grid No.3, and Internal Shield .....		3	pF
Plate to Cathode, Heater, Pentode Grid No.3, and Internal Shield .....		1.9	pF
<b>Pentode Unit:</b>			
Grid No.1 to Plate .....		0.010 max	pF
Grid No.1 to Cathode, Heater, Grid No.2, Grid No.3, and Internal Shield .....		5	pF
Plate to Cathode, Heater, Grid No.2, Grid No.3, and Internal Shield .....		3.4	pF
Heater to Cathode* .....		3.8	pF

- The dc component must not exceed 100 volts.
- △ With external shield connected to cathode except as noted.
- With external shield connected to ground.

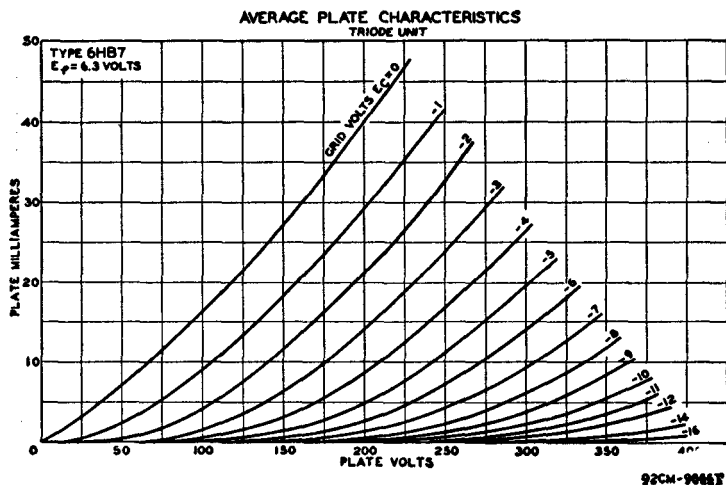

**Class A<sub>1</sub> Amplifier**

<b>MAXIMUM RATINGS</b> (Design-Maximum Values):	<b>Triode Unit</b>	<b>Pentode Unit</b>	
Plate Voltage .....	330 max	330 max	volts
Grid-No.2 (Screen-Grid) Supply Voltage .....	—	330 max	volts
Grid-No.2 Voltage .....	—	See curve page 80	

Grid-No.1 (Control-Grid) Voltage:	Triode Unit	Pentode Unit	
Positive-bias value .....	0 max	0 max	volts
Plate Dissipation .....	2.5 max	3.1 max	watts
Grid-No.2 Input:			
For grid-No.2 voltages up to 165 volts .....	—	0.55 max	watt
For grid-No.2 voltages between 165 and 330 volts .....	—	See curve page 80	

**CHARACTERISTICS:**

Plate Supply Voltage .....	150	125	volts
Grid-No.2 Supply Voltage .....	—	125	volts
Grid-No.1 Supply Voltage .....	0	-1	volts
Cathode-Bias Resistor .....	56	—	ohms
Amplification Factor .....	40	—	
Plate Resistance (Approx.) .....	0.005	0.2	megohm
Transconductance .....	8500	6400	$\mu$ mhos
Plate Current .....	18	12	mA
Grid-No.2 Current .....	—	4	mA
Grid-No.1 Voltage (Approx.) for plate current of 10 $\mu$ A .....	-12	-9	volts

**MAXIMUM CIRCUIT VALUES:**

Grid-No.1-Circuit Resistance:			
For fixed-bias operation .....	0.5 max	0.25 max	megohm
For cathode-bias operation .....	1 max	0.5 max	megohm

AVERAGE CHARACTERISTICS  
PENTODE UNIT

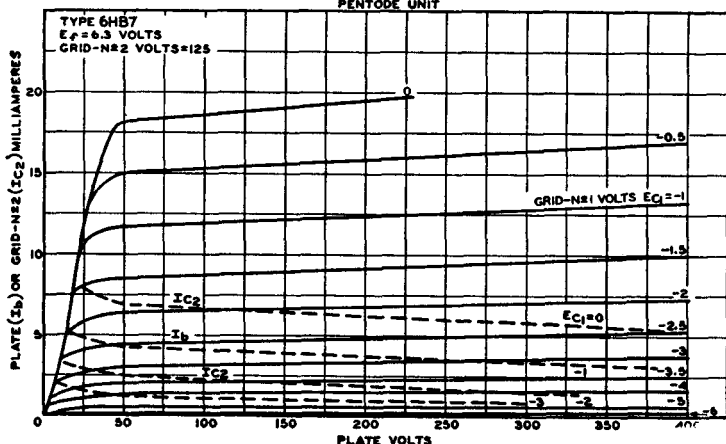
**BEAM POWER TUBE****6HE5**

Duodecar type used as vertical-deflection amplifier in television receivers. Outline 8D, Outlines section. Tube requires duodecar twelve-contact socket and may be mounted in any position. Heater volts (ac/dc),

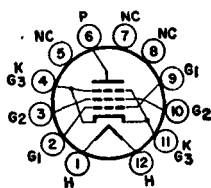
**12EY**

6.3; amperes, 0.8; peak heater-cathode volts, 200 (the dc component must not exceed 100 volts when the heater is positive with respect to the cathode).

**Class A<sub>1</sub> Amplifier**

<b>CHARACTERISTICS:</b>			
Plate Voltage .....	60	250	volts
Grid-No.2 (Screen-Grid) Voltage .....	250	250	volts
Grid-No.1 (Control-Grid) Voltage .....	0	-20	volts
Plate Resistance (Approx.) .....	—	50000	ohms
Transconductance .....	—	4100	$\mu$ mhos
Plate Current .....	130	43	mA

Grid-No.2 Current .....	20*	3.5	mA
Grid-No.1 Voltage (Approx.) for plate current of 100 $\mu$ A .....	—	—50	volts

\* This value can be measured by a method involving a recurrent waveform such that the maximum ratings of the tube will not be exceeded.

**Vertical Deflection Amplifier**

For operation in a 525-line, 30-frame system

<b>MAXIMUM RATINGS (Design-Maximum Values):</b>			
DC Plate Voltage .....	350 max		volts
Peak Positive-Pulse Plate Voltage# .....	2500 max		volts
Grid-No.2 Voltage .....	300 max		volts
Peak Cathode Current .....	260 max		mA
Average Cathode Current .....	75 max		mA
Plate Dissipation† .....	12 max		watts
Grid-No.2 Input† .....	2.75 max		watts
Bulb Temperature (At hottest point) .....	200 max		°C

**MAXIMUM CIRCUIT VALUES:**

Grid-No.1-Circuit Resistance:	
For fixed-bias operation .....	1 max megohm
For cathode-bias operation .....	2.2 max megohm*

# The duration of the voltage pulse must not exceed 15 per cent of one vertical scanning cycle. In a 525-line, 30-frame system, 15 per cent of one vertical scanning cycle is 2.5 milliseconds.  
 † An adequate bias resistor or other means is required to protect the tube in the absence of excitation.

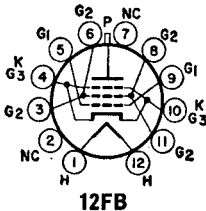

**BEAM POWER TUBE**

Duodeodec type used as horizontal-deflection amplifier in color television receivers. Outline 16B, Outlines section. Tube requires duodeodec twelve-contact socket and may be mounted in any position. Heater volts (ac/dc),

**6HF5**

6.3; amperes, 2.25; peak heater-cathode volts, 200 (the dc component must not exceed 100 volts when the heater is positive with respect to the cathode).

**Class A<sub>1</sub> Amplifier**

<b>CHARACTERISTICS:</b>				
Plate Voltage .....	5000	70	175	volts
Grid-No.2 (Screen-Grid) Voltage .....	125	125	125	volts
Grid-No.1 (Control-Grid) Voltage .....	—	0	—25	volts
Triode Amplification Factor .....	—	—	3*	
Plate Resistance (Approx.) .....	—	—	5600	ohms
Transconductance .....	—	—	11300	$\mu$ mhos
Plate Current .....	—	570*	125	mA
Grid-No.2 Current .....	—	34*	4.5	mA
Grid-No.1 Voltage (Approx.) for plate current of 1 mA .....	—140	—	—54	volts

\* Grid No.2 tied to plate; plate and grid-No.2 volts, 125; grid-No.1 volts, —25.  
 \* This value can be measured by a method involving a recurrent waveform such that the maximum ratings of the tube will not be exceeded.

**Horizontal-Deflection Amplifier**

For operation in a 525-line, 30-frame system

<b>MAXIMUM RATINGS (Design-Maximum Values):</b>			
DC Plate Supply Voltage .....	900 max		volts
Peak Positive-Pulse Plate Voltage# (Absolute Maximum) .....	7500*max		volts
Peak Negative-Pulse Plate Voltage .....	—1100 max		volts
DC Grid-No.2 Voltage .....	190 max		volts
Peak Negative-Pulse Grid-No.1 Voltage .....	—250 max		volts
Peak Cathode Current .....	1100 max		mA
Average Cathode Current .....	315 max		mA
Plate Dissipation† .....	28 max		watts
Grid-No.2 Input .....	5.5 max		watts
Bulb Temperature (At hottest point) .....	225 max		°C

**MAXIMUM CIRCUIT VALUE:**

Grid-No.1-Circuit Resistance .....	1 max megohm
------------------------------------	--------------

# The duration of the voltage pulse must not exceed 15 per cent of one horizontal scanning cycle. In a 525-line, 30-frame system, 15 per cent of one horizontal scanning cycle is 10 microseconds.

▲ Under no circumstances should this absolute value be exceeded.

† An adequate bias resistor or other means is required to protect the tube in the absence of excitation.

## HIGH-MU TRIODE— SHARP-CUTOFF PENTODE

### 6HF8

Related types:  
10HF8

Miniature type used in color and black-and-white television receivers. The triode unit is used in high-gain, sound-if stages and in sync-separator, sync-clipper, and phase-inverter circuits; pentode unit is used as video-

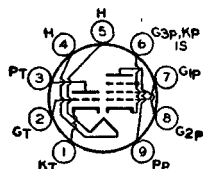

### 9DX

output amplifier. Outline 6E, **Outlines** section. Tube requires miniature nine-contact socket and may be operated in any position. For curves of average characteristics, refer to type 6AW8A for the triode unit and to type 6EB8 for the pentode unit. Type 10HF8 is identical with type 6HF8 except for the heater ratings, as shown below.

Heater Voltage (ac/dc) .....	6HF8	10HF8	
Heater Current .....	6.3	10.5	volts
Heater Warm-up Time (Average) .....	0.75	0.45	ampere
Peak Heater-Cathode Voltage:		11	seconds
Heater negative with respect to cathode .....	200 max	200 max	volts
Heater positive with respect to cathode .....	200*max	200*max	volts
Direct Interelectrode Capacitances:			
Triode Unit:			
Grid to Plate .....		3.5	pF
Grid to Cathode, Heater, Pentode Cathode, Grid No.3, and Internal Shield .....		2.8	pF
Plate to Cathode, Heater, Pentode Cathode, Grid No.3, and Internal Shield .....		2.6	pF
Pentode Unit:			
Grid No.1 to Plate .....		0.1 max	pF
Grid No.1 to Cathode, Heater, Grid No.2, Grid No.3, and Internal Shield .....		10	pF
Plate to Cathode, Heater, Grid No.2, Grid No.3, and Internal Shield .....		4.2	pF
Triode Grid to Pentode Plate .....		0.015 max	pF

\* The dc component must not exceed 100 volts.

## Class A<sub>1</sub> Amplifier

MAXIMUM RATINGS (Design-Maximum Values):	Triode Unit	Pentode Unit	
Plate Voltage .....	330 max	330 max	volts
Grid-No.2 (Screen-Grid) Supply Voltage .....	—	330 max	volts
Grid-No.2 Voltage .....	—	See curve page 80	
Grid-No.1 (Control-Grid) Voltage, Positive-bias value .....	0 max	0 max	volts
Plate Dissipation .....	1 max	5 max	watts
Grid-No.2 Input:			
For grid-No.2 voltages up to 165 volts .....	—	1.1 max	watts
For grid-No.2 voltages between 165 and 330 volts .....	—	See curve page 80	

CHARACTERISTICS:	Triode Unit	Pentode Unit	
Plate Supply Voltage .....	200	45 200	volts
Grid-No.2 Supply Voltage .....	—	125 125	volts
Grid-No.1 Voltage .....	—2	0	volts
Cathode-Bias Resistor .....	—	68	ohms
Amplification Factor .....	70	—	
Plate Resistance (Approx.) .....	17500	75000	ohms
Transconductance .....	4000	12500	μmhos
Plate Current .....	4	40* 25	mA
Grid-No.2 Current .....	—	15* 7	mA

Grid-No.1 Voltage (Approx.) for plate current of 100 $\mu$ A .....	Triode Unit	Pentode Unit	
Grid-No.1 Voltage (Approx.) for plate current of 20 $\mu$ A .....	—	—9	volts
	—6	—	volts

**MAXIMUM CIRCUIT VALUES:**

Grid-No.1-Circuit Resistance:	Triode Unit	Pentode Unit
For fixed-bias operation .....	0.5 max	0.25 max megohm
For cathode-bias operation .....	1 max	1 max megohm

\* This value can be measured by a method involving a recurrent waveform such that the maximum ratings of the tube will not be exceeded.

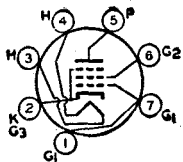

7BZ

**BEAM POWER TUBE**

Miniature type used in the audio output stages of television receivers. This type has a controlled cathode warm-up time to minimize extraneous sound during receiver warm-up. Outline 5D, Outlines section. Tube requires miniature seven-contact socket and may be mounted in any position.

**6HG5**

Heater Voltage (ac/dc) .....	6.3	volts
Heater Current .....	0.45	ampere
Cathode Warm-up Time# .....	14 min	seconds
Peak Heater-Cathode Voltage:		
Heater negative with respect to cathode .....	200 max	volts
Heater positive with respect to cathode .....	200*max	volts
Direct Interelectrode Capacitances:		
Grid No.1 to Plate .....	0.4	pF
Grid No.1 to Cathode, Heater, Grid No.2, and Grid No.3 .....	8	pF
Plate to Cathode, Heater, Grid No.2, and Grid No.3 .....	8.5	pF

# Time interval between application of voltages and rise of plate current to 1 mA; heater volts, 6.3; plate and grid-No.2 volts, 250; cathode-bias resistor, 680 ohms.

\* The dc component must not exceed 100 volts.

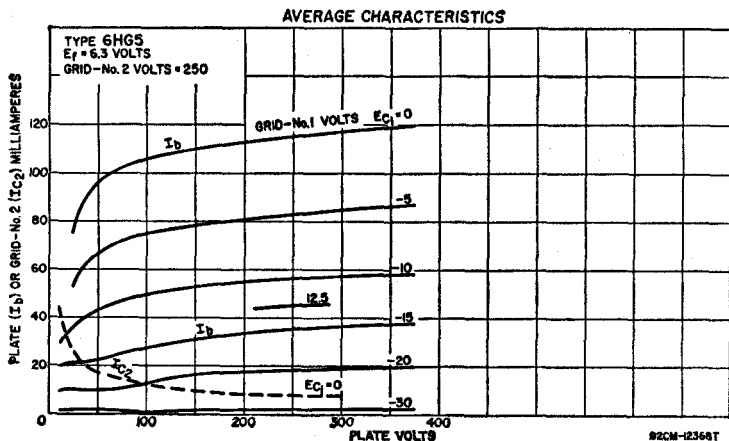

**Class A, Amplifier**

**MAXIMUM RATINGS (Design-Maximum Values):**

Plate Voltage .....	275 max	volts
Grid-No.2 (Screen-Grid) Voltage .....	275 max	volts

Plate Dissipation .....	12 max	watts
Grid-No.2 Input .....	2 max	watts
Bulb Temperature (At hottest point) .....	250 max	°C

**TYPICAL OPERATION AND CHARACTERISTICS:**

Plate Voltage .....	180	250	volts
Grid-No.2 Voltage .....	180	250	volts
Grid-No.1 (Control-Grid) Voltage .....	-8.5	-12.5	volts
Peak AF Grid-No.1 Voltage .....	8.5	12.5	volts
Zero-Signal Plate Current .....	29	45	mA
Maximum-Signal Plate Current .....	30	47	mA
Zero-Signal Grid-No.2 Current .....	3	4.5	mA
Maximum-Signal Grid-No.2 Current .....	4	7	mA
Plate Resistance (Approx.) .....	58000	52000	ohms
Transconductance .....	3700	4100	μmhos
Load Resistance .....	5500	5000	ohms
Total Harmonic Distortion .....	8	8	per cent
Maximum-Signal Power Output .....	2	4.5	watts

**MAXIMUM CIRCUIT VALUES:**

Grid-No.1-Circuit Resistance:		
For fixed-bias operation .....	0.1 max	megohm
For cathode-bias operation .....	0.5 max	megohm

## 6HG8

## 6HG8/

## ECF86

Related types:  
5HG8, 7HG8

### MEDIUM-MU TRIODE— SHARP-CUTOFF PENTODE

Miniature types with frame-grid pentode unit used as combined oscillator and mixer tubes in vhf television receivers. Outline 6B, **Outlines** section. Tubes require miniature nine-contact socket and may be mounted in any

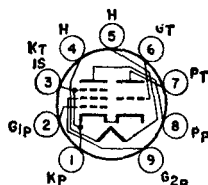

**9MP**

position. Types 5HG8 and 7HG8 are identical with types 6HG8 and 6HG8/ECF86 except for slightly higher current and dissipation ratings and for heater ratings, as shown below.

	5HG8	6HG8/ ECF86	7HG8	
Heater Voltage (ac/dc) .....	5.3	6.3	7.2	volts
Heater Current .....	0.45	0.34	0.3	ampere
Heater Warm-up Time (Average) .....	11	—	—	seconds
Peak Heater-Cathode Voltage:				
Heater negative with respect to cathode ..	100 max	100 max	100 max	volts
Heater positive with respect to cathode ..	100 max	100 max	100 max	volts

**Class A<sub>1</sub> Amplifier**

MAXIMUM RATINGS (Design-Maximum Values):	Triode Unit	Pentode Unit	
Plate Voltage .....	125 max	250 max	volts
Grid-No.2 (Screen-Grid) Voltage .....	—	150 max	volts
Cathode Current .....	15 max	18 max	mA
Plate Dissipation .....	1.5 max	2 max	watts
Grid-No.2 Input .....	—	0.5 max	watt
<b>CHARACTERISTICS:</b>			
Plate Voltage .....	100	170	volts
Grid-No.2 Voltage .....	—	150	volts
Grid-No.1 (Control-Grid) Voltage .....	-3	-1.2	volts
Amplification Factor .....	17	—	
Mu-Factor, Grid No.2 to Grid No.1 .....	—	70	
Plate Resistance (Approx.) .....	—	0.35	megohm
Transconductance .....	5500	12000	μmhos
Plate Current .....	14	10	mA
Grid-No.2 Current .....	—	3.3	mA

**MAXIMUM CIRCUIT VALUES:**

Grid-No.1-Circuit Resistance:		
For fixed-bias operation .....	—	0.25 max megohm
For cathode-bias operation .....	0.5 max	0.5 max megohm



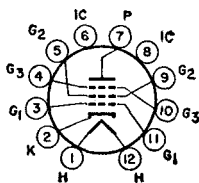

12FL

**BEAM POWER TUBE**

Duodecar type used as horizontal-deflection amplifier in television receivers. Outline 15C, **Outlines** section. Tube requires duodecar twelve-contact socket and may be mounted in any position. Type 21HJ5 is identical

with type 6HJ5 except for heater ratings, as shown below.

	6HJ5	21HJ5	
Heater Voltage (ac/dc) .....	6.3	21.5	volts
Heater Current .....	2.25	0.6	amperes
Heater Warm-up Time (Average) .....	—	11	seconds
Peak Heater-Cathode Voltage:			
Heater negative with respect to cathode .....	200 max	200 max	volts
Heater positive with respect to cathode .....	200*max	200*max	volts

\* The dc component must not exceed 100 volts.

**Class A<sub>1</sub> Amplifier**

**CHARACTERISTICS:**

Plate Voltage .....	20	40	60	135	volts
Grid-No.2 (Screen-Grid) Voltage .....	110	110	135	135	volts
Grid No.3 .....			Connected to cathode at socket		
Grid-No.1 (Control-Grid) Voltage .....	0	0	0	-22	volts
Triode Amplification Factor .....	—	—	—	4.2	
Plate Resistance (Approx.) .....	—	—	—	5000	ohms
Transconductance .....	—	—	—	10000	μmhos
Plate Current .....	240*	400*	540*	80	mA
Grid-No.2 Current .....	160*	42*	48*	5.5	mA
Grid-No.1 Voltage (Approx.) for plate current of 1 mA .....	—	—	—	-70	volts

\* This value can be measured by a method involving a recurrent waveform such that the maximum ratings of the tube will not be exceeded.

**Horizontal Deflection Amplifier**

For operation in a 525-line, 30-frame system

**MAXIMUM RATINGS (Design-Maximum Values):**

DC Plate Supply Voltage .....	770 max	volts
Peak Positive-Pulse Plate Voltage# .....	7000 max	volts
Peak Negative-Pulse Plate Voltage .....	-1500 max	volts
DC Grid-No.3 Voltage .....	70 max	volts
DC Grid-No.2 Voltage .....	220 max	volts
Peak Negative-Pulse Grid-No.1 Voltage .....	-330 max	volts
Peak Cathode Current .....	1000 max	mA
Average Cathode Current .....	280 max	mA
Plate Dissipation† .....	24 max	watts
Grid-No.2 Input .....	6 max	watts
Bulb Temperature (At hottest point) .....	240 max	°C

**MAXIMUM CIRCUIT VALUE:**

Grid-No.1-Circuit Resistance .....

1 max megohm

# The duration of the voltage pulse must not exceed 15 per cent of one horizontal scanning cycle. In a 525-line, 30-frame system, 15 per cent of one horizontal scanning cycle is 10 microseconds.

† An adequate bias resistor or other means is required to protect the tube in the absence of excitation.

**DIODE—  
SHARP-CUTOFF PENTODE**

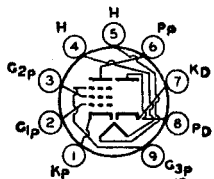

9CY

Miniature type used as combined video-detector and if-amplifier tube in television receivers employing series-connected heater strings. Outline 6B, **Outlines** section. Tube requires miniature nine-contact socket and may be mounted in any position.

**6HJ5**

Related type:  
21HJ5

**6HJ8**

Heater Voltage (ac/dc) .....	6.3	volts
Heater Current .....	0.45	ampere
Heater Warm-up Time (Average) .....	11	seconds
Peak Heater-Cathode Voltage:		
Heater negative with respect to cathode .....	200 max	volts
Heater positive with respect to cathode .....	200 max	volts
Direct Interelectrode Capacitances:		
Diode Unit:		
Plate to Cathode and Heater .....	2.4	pF
Cathode to Plate and Heater .....	3	pF
Pentode Unit:		
Grid No.1 to Plate .....	0.015 max	pF
Grid No.1 to Cathode, Heater, Grid No.2, Grid No.3, and Internal Shield .....	7	pF
Plate to Cathode, Heater, Grid No.2, Grid No.3, and Internal Shield .....	3.2	pF
Diode Plate to Pentode Grid No.1 .....	0.005 max	pF
Diode Cathode to Pentode Plate .....	0.15 max	pF
Diode Plate to Pentode Plate .....	0.035 max	pF

### Pentode Unit as Class A<sub>1</sub> Amplifier

#### MAXIMUM RATINGS (Design-Maximum Values):

Plate Voltage .....	330 max	volts
Grid-No.2 (Screen-Grid) Supply Voltage .....	330 max	volts
Grid-No.2 Voltage .....	See curve page 80	
Grid-No.1 (Control-Grid) Voltage, Positive-bias value .....	0 max	volts
Grid-No.2 Input:		
For grid-No.2 voltages up to 165 volts .....	0.55 max	watt
For grid-No.2 voltages between 165 and 330 volts .....	See curve page 80	
Plate Dissipation .....	3.2 max	watts

#### CHARACTERISTICS:

Plate Supply Voltage .....	125	volts
Grid No.3 .....	Connected to cathode at socket	
Grid-No.2 Supply Voltage .....	125	volts
Cathode-Bias Resistor .....	56	ohms
Plate Resistance (Approx.) .....	0.2	megohm
Transconductance .....	9300	μmhos
Plate Current .....	11.5	mA
Grid-No.2 Current .....	3.6	mA
Grid-No.1 Voltage (Approx.) for plate current of 20 μA .....	-6	volts
Grid-No.1 Voltage (Approx.) for plate current of 2 mA and no cathode-bias resistor .....	-3	volts

### Diode Unit

#### MAXIMUM RATINGS (Design-Maximum Values):

DC Plate Current .....	5 max	mA
CHARACTERISTICS, Instantaneous Value:		
Tube Voltage Drop for plate current of 50 mA .....	10	volts

## HIGH-MU TRIODE

# 6HK5

Miniature type with frame grid used in vhf tuners of television receivers. Outline 5C, **Outlines** section. Tube requires miniature seven-contact socket and may be mounted in any position.

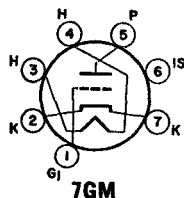

Heater Voltage (ac/dc) .....	6.3	volts
Heater Current .....	0.19	ampere
Peak Heater-Cathode Voltage:		
Heater negative with respect to cathode .....	100 max	volts
Heater positive with respect to cathode .....	100 max	volts
Direct Interelectrode Capacitances:*		
Grid to Plate .....	0.29	pF
Grid to Cathode, Heater, and Internal Shield .....	4.4	pF
Plate to Cathode, Heater, and Internal Shield .....	2.6	pF
Heater to Cathode .....	2.5	pF

\* With external shield.

**Class A<sub>1</sub> Amplifier**

**MAXIMUM RATINGS (Design-Maximum Values):**

Plate Voltage	200 max	volts
Grid Voltage, Negative-bias Value	-50 max	volts
Cathode Current	22 max	mA
Plate Dissipation	2.3 max	watts

**CHARACTERISTICS:**

Plate Voltage	135	volts
Grid Voltage	-1	volt
Amplification Factor	75	
Plate Resistance (Approx.)	5000	ohms
Transconductance	15000	μmhos
Plate Current	12.5	mA
Grid Voltage (Approx.) for transconductance of 150 μmhos	-5	volts
Grid Voltage (Approx.) for transconductance of 1500 μmhos	-2.6	volts
Input Resistance**	600	ohms
Input Capacitance**	9	pF
Noise Figure#	4.2	dB

**MAXIMUM CIRCUIT VALUES:**

Grid-Circuit Resistance:	
For cathode-bias operation	1 max megohm

\*\* Measured at 200 Mc/s with plate effectively grounded for rf voltages.

# For a neutralized triode amplifier at a frequency of 200 Mc/s with signal source impedance adjusted for minimum noise output.

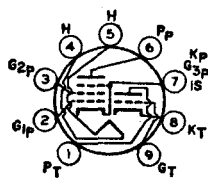

9AE

**MEDIUM-MU TRIODE—  
SHARP-CUTOFF PENTODE**

Miniature type used in a wide variety of applications in television receivers employing series-connected heater strings. The triode unit is used as a sync-separator or voltage-amplifier tube, and the pentode unit is used as

**6HL8**

a video if-amplifier, agc-amplifier, or reactance tube. Outline 6B, Outlines section. Tube requires miniature nine-contact socket and may be mounted in any position. Heater volts (ac/dc), 6.3; amperes, 0.6; warm-up time (average), 11 seconds; peak heater-cathode volts, 200 (the dc component must not exceed 100 volts when the heater is positive with respect to the cathode).

**Class A<sub>1</sub> Amplifier**

**MAXIMUM RATINGS (Design-Maximum Values):**

	Triode Unit	Pentode Unit	
Plate Voltage	330 max	330 max	volts
Grid-No.2 (Screen-Grid) Supply Voltage	—	330 max	volts
Grid-No.2 Voltage	—	See curve page 80	
Grid-No.1 (Control-Grid) Voltage, Positive-bias value	0 max	0 max	volts
Plate Dissipation	2.5 max	2.5 max	watts
Grid-No.2 Input:			
For grid-No.2 voltages up to 165 volts	—	0.55 max	watt
For grid-No.2 voltages between 165 and 330 volts		See curve page 80	

**CHARACTERISTICS:**

Plate Voltage	125	125	volts
Grid-No.2 Voltage	—	125	volts
Grid-No.1 Voltage	-1	-1	volt
Amplification Factor	40	—	
Plate Resistance (Approx.)	5000	15000	ohms
Transconductance	7000	10000	μmhos
Plate Current	12.5	12	mA
Grid-No.2 Current	—	4.5	mA
Grid-No.1 Voltage (Approx.) for plate current of 20 μA	—	-7	volts

**MAXIMUM CIRCUIT VALUES:**

Grid-No.1-Circuit Resistance	1 max	—	megohm
------------------------------	-------	---	--------

## HIGH-MU TRIODE

**6HM5/  
6HA5**Related type:  
3HM5/3HA5

Miniature type used as rf-amplifier tube in vhf television tuners. Outline 5C, **Outlines** section. Tube requires miniature seven-contact socket and may be mounted in any position. Type 3HM5/3HA5 is identical with

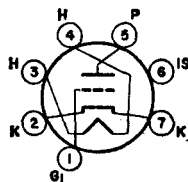

7GM

type 6HM5/6HA5 except for heater ratings, as shown below.

	3HM5/3HA5	6HM5/6HA5	
Heater Voltage (ac/dc)	2.7	6.3	volts
Heater Current	0.45	0.18	ampere
Peak Heater-Cathode Voltage:			
Heater negative with respect to cathode	110 max	110 max	volts
Heater positive with respect to cathode	110 max	110 max	volts

Class A<sub>1</sub> Amplifier

## MAXIMUM RATINGS (Design-Maximum Values):

DC Plate Voltage	220 max	volts
DC Plate Supply Voltage	600 max	volts
Grid Voltage	-50 max	volts
Cathode Current	22 max	mA
Plate Dissipation	2.6 max	watts

## CHARACTERISTICS AND TYPICAL

## OPERATION:

	Fixed Bias		Cathode Bias		
	135	135	135	135	
DC Plate Supply Voltage	—	—	1000	5600	ohms
Plate-Load Resistor	0	0	0	0	volts
Internal-Shield Voltage	-1	-2.7	—	—	volts
DC Grid Voltage	—	—	0	87	ohms
Cathode-Bias Resistor	72	—	80	72	
Amplification Factor	14500	1500	20000	14500	μmhos
Transconductance	11.5	—	19	11.5	mA
Plate Current	—	—	10	—	μA
DC Grid Current	—	—	-5.3	-8.1	volts
Grid-No.1 Voltage for one-per-cent transconductance	—	—	—	—	

## SHARP-CUTOFF PENTODE

**6HM6**Related type:  
4HM6

Miniature type with frame grid used in the if-amplifier stages of television receivers Outline 6B, **Outlines** section. Tube requires miniature nine-contact socket and may be mounted in any position. Type 4HM6 is identical with

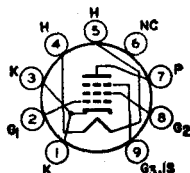

9PM

type 6HM6 except for the heater ratings, as shown below.

	4HM6	6HM6	
Heater Voltage (ac/dc)	4.2	6.3	volts
Heater Current	0.45	0.3	ampere
Heater Warm-up Time (Average)	11	—	seconds
Peak Heater-Cathode Voltage:			
Heater negative with respect to cathode	200 max	200 max	volts
Heater positive with respect to cathode	200*max	200 max	volts

\* The dc component must not exceed 100 volts.

Class A<sub>1</sub> Amplifier

## MAXIMUM RATINGS (Design-Maximum Values):

Plate Voltage	250 max	volts
Grid-No.2 (Screen-Grid) Supply Voltage	250 max	volts
Grid-No.2 Voltage	See curve page 80	
Grid-No.1 (Control-Grid) Voltage, Negative-bias value	-50 max	volts

Cathode Current .....	25 max	mA
Plate Dissipation .....	2.5 max	watts
Grid-No.2 Input:		
For grid-No.2 voltages up to 125 volts .....	2.5 max	watt
For grid-No.2 voltages between 125 and 250 volts .....	See curve page 80	

**CHARACTERISTICS:**

Plate Supply Voltage .....	125	volts
Grid No.3 (Suppressor Grid) .....	Connected to cathode at socket	
Grid-No.2 Supply Voltage .....	125	volts
Cathode-Bias Resistor .....	56	ohms
Plate Resistance (Approx.) .....	0.156	megohm
Transconductance .....	15000	$\mu$ mhos
Plate Current .....	13	mA
Grid-No.2 Current .....	3.2	mA
Grid-No.1 Voltage (Approx.) for transconductance of 100 $\mu$ mhos .....	-3	volts

**MAXIMUM CIRCUIT VALUES:**

Grid-No.1-Circuit Resistance:		
For fixed-bias operation .....	0.25 max	megohm
For cathode-bias operation .....	1 max	megohm

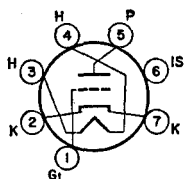

**7GM**

**HIGH-MU TRIODE**

Miniature type used as grounded-cathode rf-amplifier tube in vhf tuners of television receivers. Outline 5C, **Outlines** section. Tube requires miniature seven-contact socket and may be operated in any position. Types 2HQ5 and 3HQ5 are identical with type 6HQ5 except for the heater ratings, as shown below.

**6HQ5**

Related types:  
2HQ5, 3HQ5

	2HQ5	3HQ5	6HQ5	
Heater Voltage (ac/dc) .....	2.4	3	6.3	volts
Heater Current .....	0.6	0.45	0.2	ampere
Heater Warm-up Time (Average) .....	11	11	—	seconds
Peak Heater-Cathode Voltage:				
Heater negative with respect to cathode ..	100	100	100	volts
Heater positive with respect to cathode ..	100	100	100	volts
Direct Interelectrode Capacitances (Approx.):*				
Grid to Plate .....			0.52	pF
Grid to Cathode, Heater, and Internal Shield .....			5	pF
Plate to Cathode, Heater, and Internal Shield .....			3.5	pF
Heater to Cathode .....			2.5	pF

\* With external shield connected to cathode.

**Class A<sub>1</sub> Amplifier**

**MAXIMUM RATINGS (Design-Maximum Values):**

Plate Voltage .....	200 max	volts
Grid Voltage, Negative-bias Value .....	-50 max	volts
Cathode Current .....	22 max	mA
Plate Dissipation .....	2.5 max	watts

**CHARACTERISTICS:**

Plate Voltage .....	135	volts
Grid Voltage .....	-1	volt
Amplification Factor .....	78	
Plate Resistance .....	5400	ohms
Transconductance .....	15000	$\mu$ mhos
Plate Current .....	11.5	mA
Grid Voltage (Approx.) for transconductance of 150 $\mu$ mhos .....	-4.2	volts
Grid Voltage (Approx.) for transconductance of 1500 $\mu$ mhos .....	-2.5	volts
Input Resistance** .....	275	ohms
Input Capacitance** .....	11.2	pF
Noise Figure# .....	4.7	dB

**MAXIMUM CIRCUIT VALUES:**

Grid-Circuit Resistance:

For cathode-bias operation ..... 1 max megohm

\*\* Measured at 200 Mc/s with heater volts = 6.3 volts and plate effectively grounded for fr voltages.

# For a neutralized triode amplifier at a frequency of 200 Mc/s with signal source impedance adjusted for minimum noise output.

**SEMIREMOTE-CUTOFF PENTODE**

**6HR6**

Related type:  
19HR6

Miniature type used as if-amplifier tube in FM receivers employing series-connected heater strings. Outline 5C, Outlines section. Tube requires miniature seven-contact socket and may be mounted in any position. Type

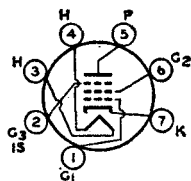

**7BK**

19HR6 is identical with type 6HR6 except for the heater ratings, as shown below.

Heater Voltage (ac/dc) .....	6HR6	19HR6	
Heater Current .....	6.3	18.9	volts
Heater Warm-up Time (Average) .....	0.45	0.15	ampere
Peak Heater-Cathode Voltage:			seconds
Heater negative with respect to cathode .....	200 max	200 max	volts
Heater positive with respect to cathode .....	200*max	200*max	volts
Direct Interelectrode Capacitances:			
Grid No.1 to Plate .....		0.006 max	pF
Grid No.1 to Cathode, Heater, Grid No.2, Grid No.3, and Internal Shield .....		8.8	pF
Plate to Cathode, Heater, Grid No.2, Grid No.3, and Internal Shield .....		5.2	pF

\* The dc component must not exceed 100 volts.

**AVERAGE CHARACTERISTICS**

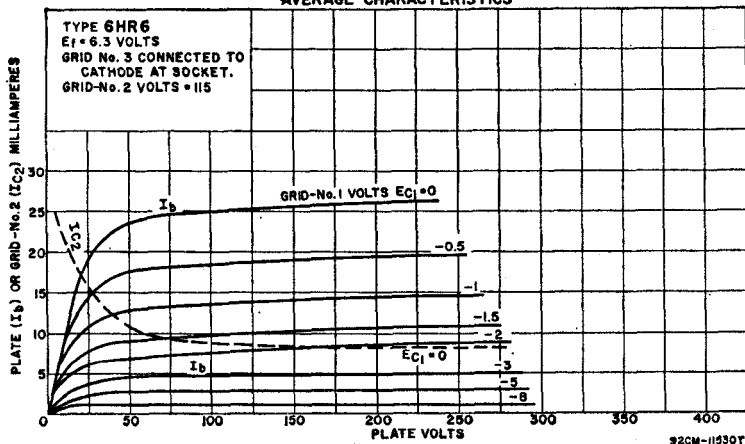

**Class A<sub>1</sub> Amplifier**

**MAXIMUM RATINGS (Design-Maximum Values):**

Plate Supply Voltage .....	300 max	volts
Grid-No.3 (Suppressor-Grid) Voltage, Positive value .....	0 max	volts
Grid-No.2 (Screen-Grid) Supply Voltage .....	300 volts	volts
Grid-No.2 Voltage .....	See curve page 80	
Grid-No.1 (Control-Grid) Voltage:		
Negative-bias value .....	-50 max	volts
Positive-bias value .....	0 max	volts

Plate Dissipation .....	3 max	watts
Grid-No.2 Input:		
For grid-No.2 voltages up to 150 volts .....	1 max	watt
For grid-No.2 voltages between 150 and 300 volts .....	See curve page 80	

**CHARACTERISTICS:**

Plate Supply Voltage .....	200	volts
Grid No.3 .....	Connected to cathode at socket	
Grid-No.2 Supply Voltage .....	115	volts
Grid-No.1 Supply Voltage .....	0	volts
Cathode-Bias Resistor .....	68	ohms
Plate Resistance (Approx.) .....	0.5	megohm
Transconductance .....	8500	$\mu$ mhos
Grid-No.1 Voltage (Approx.) for transconductance of 60 $\mu$ mhos .....	-15	volts
Plate Current .....	13.2	mA
Grid-No.2 Current .....	4.3	mA

**MAXIMUM CIRCUIT VALUES:**

Grid-No.1-Circuit Resistance:		
For fixed-bias operation .....	0.5 max	megohm
For cathode-bias operation .....	1 max	megohm

**SHARP-CUTOFF PENTODE**

**6HS6**

Related type:  
19HS6

Miniature type used as if-amplifier and limiter tube in FM receivers. Outline 5C, **Outlines** section. Tube requires miniature seven-contact socket and may be mounted in any position. Type 19HS6 is identical with type

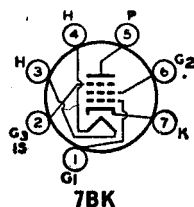

6HS6 except for the heater ratings, as shown below.

	<b>6HS6</b>	<b>19HS6</b>	
Heater Voltage (ac/dc) .....	6.3	18.4	volts
Heater Current .....	0.45	0.15	ampere seconds
Heater Warm-up Time (Average) .....	11	17	
Peak Heater-Cathode Voltage:			
Heater negative with respect to cathode .....	200 max	200 max	volts
Heater positive with respect to cathode .....	200*max	200*max	volts
Direct Interelectrode Capacitances:			
Grid No.1 to Plate .....		0.006 max	volts
Grid No.1 to Cathode, Heater, Grid No.2, Grid No.3, and Internal Shield .....		8.8	pF
Plate to Cathode, Heater, Grid No.2, Grid No.3, and Internal Shield .....		5.2	pF

\* The dc component must not exceed 100 volts.

**Class A<sub>1</sub> Amplifier**

**MAXIMUM RATINGS (Design-Maximum Values):**

Plate Supply Voltage .....	300 max	volts
Grid-No.3 (Suppressor-Grid) Voltage, Positive Value .....	0 max	volts
Grid-No.2 (Screen-Grid) Supply Voltage .....	300 max	volts
Grid-No.2 Voltage .....	See curve page 80	
Grid-No.1 (Control-Grid) Voltage:		
Negative-bias value .....	-50 max	volts
Positive-bias value .....	0 max	volts
Plate Dissipation .....	3 max	watts
Grid-No.2 Input:		
For grid-No.2 voltages up to 150 volts .....	1 max	watt
For grid-No.2 voltages between 150 and 300 volts .....	See curve page 80	

**CHARACTERISTICS:**

Plate Supply Voltage .....	75	150	volts
Grid No.3 .....	Connected to cathode at socket		
Grid-No.2 Supply Voltage .....	75	75	volts
Grid-No.1 Supply Voltage .....	0	0	volts
Cathode-Bias Resistor .....	68	68	ohms
Amplification Factor* .....	50	—	
Plate Resistance (Approx.) .....	—	0.5	megohm

Transconductance .....	—	9500	$\mu$ mhos
Plate Current .....	—	8.8	mA
Grid-No.2 Current .....	—	2.8	mA
Grid-No.1 Voltage (Approx.) for plate current of 20 $\mu$ A	—	-4	volts

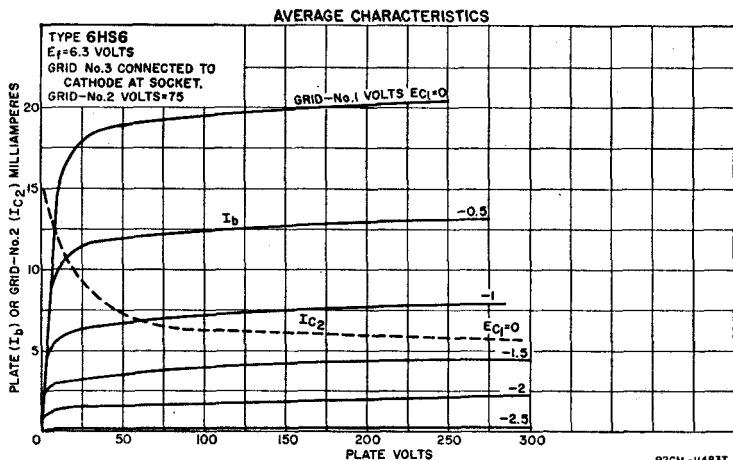

92CM-11483T

**MAXIMUM CIRCUIT VALUES:**

Grid-No.1-Circuit Resistance:

For fixed-bias operation .....	0.5 max	megohm
For cathode-bias operation .....	1 max	megohm

**SHARP-CUTOFF TWIN PENTODE**

Miniature type used in agc amplifier, sync, and noise-limiting circuits of television receivers. One pentode unit is used as combined sync separator and sync clipper; second pentode unit is used as agc amplifier. Outline 6E,

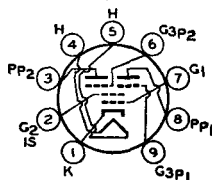

**6HS8**

Related type:  
3HS8, 4HS8

**9FG**

**Outlines section.** Tube requires miniature nine-contact socket and may be operated in any position. Type 3HS8 and 4HS8 are identical with type 6HS8 except for the heater ratings, as shown below.

	3HS8	4HS8	6HS8	
Heater Voltage (ac/dc) .....	3.15	4.2	6.3	volts
Heater Current .....	0.6	0.45	0.3	ampere
Heater Warm-up Time (Average) .....	11	11	—	seconds
Peak Heater-Cathode Voltage:				
Heater negative with respect to cathode ...	200 max	200 max	200 max	volts
Heater positive with respect to cathode ...	200 max	200 max	200 max	volts
Direct Interelectrode Capacitances:				
Grid No.3 to Plate (Each Unit) .....			2	pF
Grid No.1 to All Other Electrodes .....			6	pF
Grid No.3 (Each Unit) to All Other Electrodes .....			3.6	pF
Plate (Each Unit) to All Other Electrodes .....			3	pF
Grid No.3 (Unit No.1) to Grid No.3 (Unit No.2) .....			0.015 max	pF

• The dc component must not exceed 100 volts.

**Class A<sub>1</sub> Amplifier**

**MAXIMUM RATINGS (Design-Maximum Values):**

Plate Voltages (Each Unit) .....	300 max	volts
----------------------------------	---------	-------



Grid-No.3 (Suppressor-Grid) Voltage (Each Unit):

Peak positive value .....	50 max	volts
DC negative value .....	-50 max	volts
DC positive value .....	3 max	volts

Grid-No.2 (Screen-Grid) Voltage

Grid-No.1 (Control-Grid) Voltage, Negative-bias value .....	150 max	volts
---	---------	-------

Cathode Current .....	-50 max	volts
-----------------------	---------	-------

Plate Dissipation (Each Unit) .....	12 max	mA
-------------------------------------	--------	----

Grid-No.2 Input .....	1.1 max	watts
-----------------------	---------	-------

Grid-No.1 Input .....	0.75 max	watt
-----------------------	----------	------

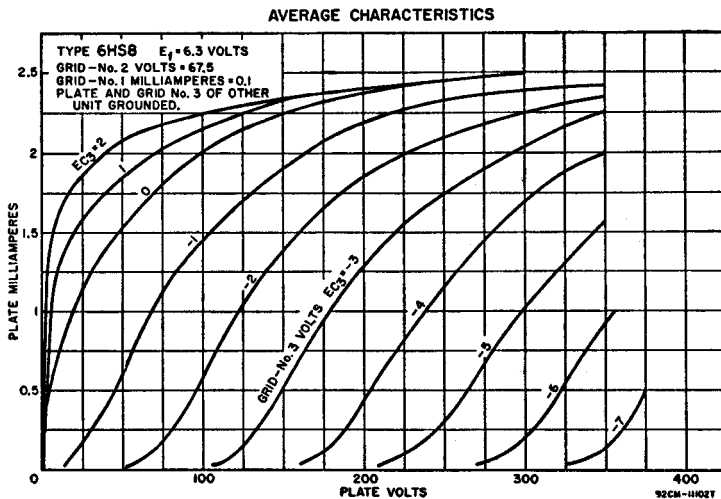
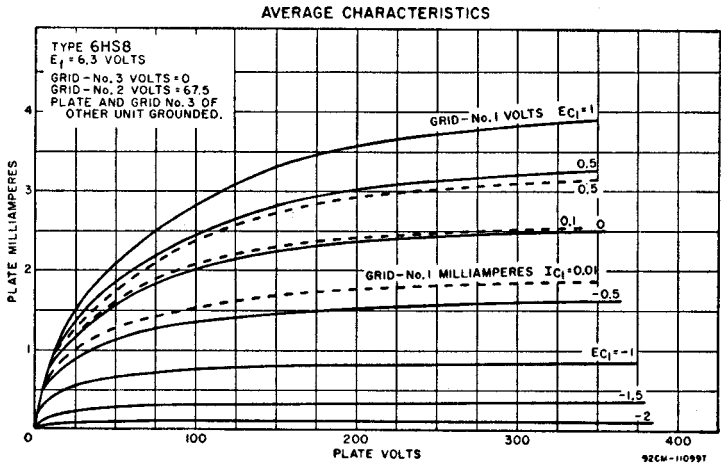

CHARACTERISTICS:

With One Unit Operating\*

Plate Voltage .....	100	100	volts
Grid-No.3 Voltage .....	0	0	volts
Grid-No.2 Voltage .....	67.5	67.5	volts
Grid-No.1 Voltage .....	0	□	volts
Transconductance, Grid-No.3-to-Plate .....	—	450	μmhos
Transconductance, Grid-No.1-to-Plate .....	1100	—	μmhos
Plate Current .....	—	2	mA

Grid-No.3 Voltage (Approx.) for plate current of 100 $\mu$ A	—	—3.5	volts
Grid-No.1 Voltage (Approx.) for plate current of 100 $\mu$ A	—	—2.3	volts
With Both Units Operating			
Plate Voltage (Each Unit)	100	100	volts
Grid-No.3 Voltage (Each Unit)	—10	0	volts
Grid-No.2 Voltage	67.5	67.5	volts
Grid-No.1 Voltage	□	□	volts
Plate Current (Each Unit)	—	2	mA
Grid-No.2 Current	7	4.4	mA
Cathode Current	7.1	8.5	mA

**MAXIMUM CIRCUIT VALUES:**

Grid-No.3-Circuit Resistance (Each Unit)	0.5 max	megohm
Grid-No.1-Circuit Resistance	0.5 max	megohm

• With plate and grid No.3 of other unit connected to ground.

□ Adjusted to give grid-No.1 current of 0.1 milliamperes.

**SHARP-CUTOFF PENTODE****6HZ6**

Miniature type used as sound-detector tube in FM and television receivers employing series-connected heater strings. Tube has two independent control grids. Outline 5C, Outlines section. Tube requires miniature

seven-contact socket and may be mounted in any position.

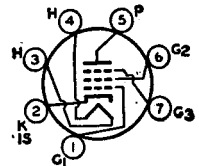
**7EN**

Heater Voltage (ac/dc)	6.3	volts
Heater Current	0.45	ampere
Heater Warm-up Time (Average)	11	seconds
Peak Heater-Cathode Voltage:		
Heater negative with respect to cathode	200 max	volts
Heater positive with respect to cathode	200*max	volts
Direct Interelectrode Capacitances (Approx.):		
Grid No.1 to Plate	0.023	pF
Grid No.1 to Cathode, Heater, Grid No.2, Grid No.3, and Internal Shield	8.2	pF
Grid No.1 to Grid No.3	0.09	pF
Grid No.3 to Plate	1.6	pF
Grid No.3 to Cathode, Heater, Grid No.1, Grid No.2, Plate, and Internal Shield	7.2	pF

\* The dc component must not exceed 100 volts.

**Class A<sub>1</sub> Amplifier****CHARACTERISTICS:**

Plate Supply Voltage	150	volts
Grid-No.3 Supply Voltage	0	volts
Grid-No.2 Supply Voltage	100	volts
Grid-No.1 Supply Voltage	0	volts
Cathode-Bias Resistor	180	ohms
Plate Resistance (Approx.)	0.11	megohm
Transconductance, Grid No.1 to Plate	3400	$\mu$ mhos
Transconductance, Grid No.3 to Plate	600	$\mu$ mhos
Plate Current	3.2	mA
Grid-No.2 Current	3.2	mA
Grid-No.3 Supply Voltage (Approx.) for plate current of 20 $\mu$ A	—7	volts
Grid-No.1 Supply Voltage (Approx.) for plate current of 20 $\mu$ A	—4.5	volts

**FM Sound Detector****MAXIMUM RATINGS (Design-Maximum Values):**

Plate Voltage	300 max	volts
Grid-No.3 (Control-Grid) Voltage:		
Negative value (dc and peak ac)	—100 max	volts
Positive value (dc and peak ac)	25 max	volts
Grid-No.2 (Screen-Grid) Supply Voltage	300 max	volts
Grid-No.2 Voltage	See curve page 80	

Grid-No.1 (Control-Grid) Voltage:

Negative-bias value .....	-50 max	volts
Positive-bias value .....	0 max	volts
Plate Dissipation .....	1.7 max	watts
Grid-No.3 Input .....	0.1 max	watt
Grid-No.2 Input:		
For grid-no.2 voltages up to 150 volts .....	1 max	watt
For grid-no.2 voltages between 150 and 300 volts .....	See curve page 80	

MAXIMUM CIRCUIT VALUES:

Grid-No.3-Circuit Resistance .....	0.68 max	megohm
Grid-No.1-Circuit Resistance:		
For fixed-bias operation .....	0.22 max	megohm
For cathode-bias operation .....	0.47 max	megohm

AVERAGE CHARACTERISTICS

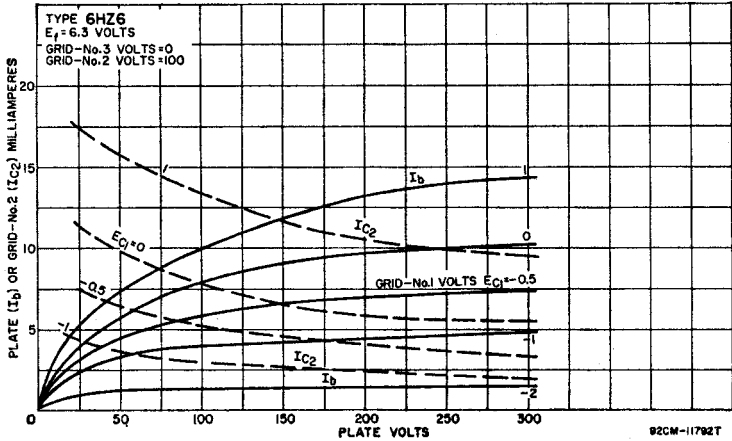

AVERAGE CHARACTERISTICS

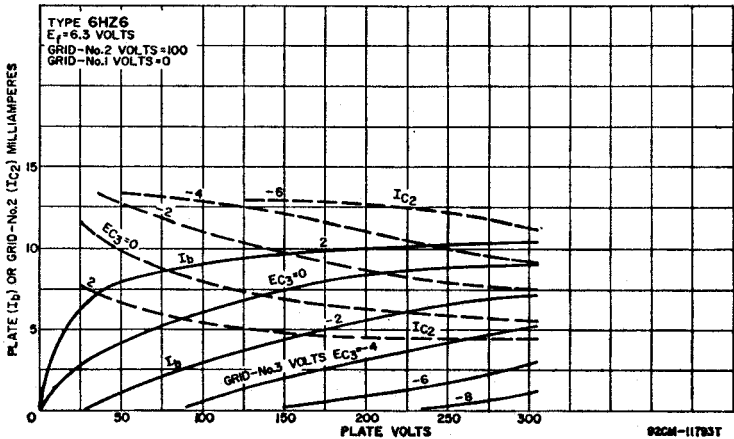

## HIGH-MU TRIODE— SHARP-CUTOFF PENTODE

# 6HZ8

Miniature type used in television receivers. The triode unit is used as a voltage amplifier or sync separator, and the pentode unit as a video amplifier. Outline 8E, **Outlines** section.

Tube requires duodecator nine-contact

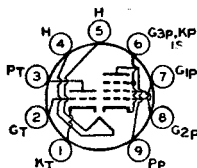

### 9DX

socket and may be mounted in any position. Heater volts (ac/dc), 6.3; amperes, 1.125; peak heater-cathode volts, 200 (the dc component must not exceed 100 volts when the heater is positive with respect to the cathode).

### Class A<sub>1</sub> Amplifier

#### MAXIMUM RATINGS (Design-Maximum Values):

	Triode Unit	Pentode Unit	
Plate Voltage	300 max	300 max	volts
Grid-No.2 (Screen-Grid) Supply Voltage	—	330 max	volts
Grid-No.2 Voltage	—	See curve page 80	volts
Grid-No.1 (Control-Grid) Voltage, Positive bias value	0 max	0 max	volts
Plate Dissipation	1 max	8 max	watts
Grid-No.2 Input:			
For grid-No.2 voltages up to 165 volts	—	2 max	watts
For grid-No.2 voltages between 165 and 330 volts	—	See curve page 80	

#### CHARACTERISTICS:

Plate Voltage	200	60	250	volts
Grid-No.2 Supply Voltage	—	170	170	volts
Grid-No.1 Voltage	-2	0	—	volts
Cathode-Bias Resistor	—	—	100	ohms
Amplification Factor	70	—	—	
Plate Resistance (Approx.)	—	—	0.14	megohm
Transconductance	4000	—	12600	μmhos
Plate Current	3.5	90*	29	mA
Grid-No.2 Current	—	22.5*	6	mA
Grid-No.1 Voltage (Approx.) for plate current of 10 μA	-5	—	-11.5	volts

#### MAXIMUM CIRCUIT VALUES:

Grid-No.1-Circuit Resistance:			
For fixed-bias operation	0.5 max	0.25 max	megohm
For cathode-bias operation	1 max	1 max	megohm

\* This value can be measured by a method involving a recurrent waveform such that the maximum ratings of the tube will not be exceeded.

## MEDIUM-MU TWIN TRIODE

# 6J6A

Related type:  
5J6

Miniature type used as combined rf power amplifier and oscillator or as twin af amplifier. With push-pull arrangement of the grids and the plates in parallel this type can also be used as a mixer at frequencies as high as

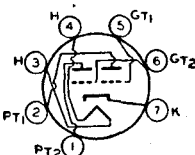

### 7BF

600 megacycles per second. Outline 5C, **Outlines** section. Tube requires miniature seven-contact socket and may be mounted in any position. Type 5J6 is identical with type 6J6A except for the heater ratings, as shown below.

	5J6	6J6A	
Heater Voltage (ac/dc)	4.7	6.3	volts
Heater Current	0.6	0.45	ampere
Heater Warm-up Time (Average)	11	11	seconds
Peak Heater-Cathode Voltage:			
Heater negative with respect to cathode	100 max	100 max	volts
Heater positive with respect to cathode	100 max	100 max	volts

	Without External Shield	With External Shield	
Direct Interelectrode Capacitances (Each Unit, Approx.):			
Grid to Plate .....	1.6	1.6	pF
Grid to Cathode and Heater .....	2.2	2.6	pF
Plate to Cathode and Heater (Unit No.1) .....	0.4	1.6	pF
Plate to Cathode and Heater (Unit No.2) .....	0.4	1	pF

**Class A<sub>1</sub> Amplifier (Each Unit)**

MAXIMUM RATINGS (Design-Center Values):		
Plate Voltage .....	300 max	volts
Grid Voltage, Positive-bias value .....	0 max	volts
Plate Dissipation .....	1.5 max	watts

CHARACTERISTICS:		
Plate Voltage .....	100	volts
Cathode-Bias Resistor .....	50†	ohms
Amplification Factor .....	38	
Plate Resistance (Approx.) .....	7100	ohms
Transconductance .....	5300	μmhos
Plate Current .....	8.5	mA

MAXIMUM CIRCUIT VALUES:		
Grid-Circuit Resistance:		
For fixed-bias operation .....	Not recommended	
For cathode-bias operation .....	0.5 max megohm	

† Value is for both units operating at the specified conditions.

**RF Power Amplifier and Oscillator—Class C Telegraphy**

Key-down conditions per tube without modulation

MAXIMUM RATINGS (Design-Center Values, Each Unit):		
Plate Voltage .....	300 max	volts
Grid Voltage:		
Negative-bias value .....	-40 max	volts
Positive-bias value .....	0 max	volts
Plate Current .....	15 max	mA
Grid Current .....	8 max	mA
Plate Input .....	4.5 max	watts
Plate Dissipation .....	1.5 max	watts

TYPICAL PUSH-PULL OPERATION (Both Units):		
Plate Voltage .....	150	volts
Grid Voltage* .....	-10	volts
Plate Current .....	30	mA
Grid Current (Approx.) .....	16	mA
Driving Power (Approx.) .....	0.35	watt
Power Output (Approx.) .....	3.5	watts

\* Obtained by grid resistor (625 ohms), cathode-bias resistor (220 ohms), or fixed supply.

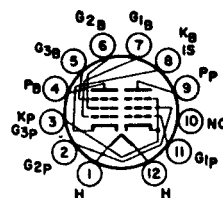

12BT

**PENTODE—  
BEAM POWER TUBE**

Duodecator type used in FM and television receivers. The pentode unit is used as a gated-beam discriminator and the beam power unit is used in audio power-output stages in FM and television limiter and discriminator

applications. Outline 8B, Outlines section. Tube requires duodecator twelve-contact socket and may be mounted in any position. Type 13J10 is identical with type 6J10 except for heater ratings, as shown below.

**6J10**

Related type:  
13J10

Heater Voltage (ac/dc) .....	6J10 6.3	13J10 13.2	volts
Heater Current .....	0.95	0.45	ampere
Heater Warm-up Time (Average) .....	—	11	seconds

Peak Heater-Cathode Voltage:			
Heater negative with respect to cathode .....	200 max	200 max	volts
Heater positive with respect to cathode .....	200*max	200*max	volts

\* The dc component must not exceed 100 volts.

### Pentode Unit as Class A<sub>1</sub> Amplifier

#### MAXIMUM RATINGS (Design-Maximum Values):

Plate Voltage .....	275 max	volts
Grid-No.2 (Screen-Grid) Voltage .....	275 max	volts
Plate Dissipation .....	10 max	watts
Grid-No.2 Input .....	2 max	watts

#### CHARACTERISTICS AND TYPICAL OPERATION:

Plate Voltage .....	250	volts
Grid-No.2 Voltage .....	250	volts
Grid-No.1 Voltage .....	-8	volts
Peak AF Grid-No.1 Voltage .....	8	volts
Plate Resistance (Approx.) .....	0.1	megohm
Transconductance .....	6500	μmhos
Zero-Signal Plate Current .....	35	mA
Maximum-Signal Plate Current .....	39	mA
Zero-Signal Grid-No.2 Current .....	2.5	mA
Maximum-Signal Grid-No.2 Current .....	7	mA
Load Resistance .....	5000	ohms
Total Harmonic Distortion (Approx.) .....	10	per cent
Maximum-Signal Power Output .....	4.2	watts

#### MAXIMUM CIRCUIT VALUES:

Grid-No.1-Circuit Resistance:		
For fixed-bias operation .....	0.25 max	megohm
For cathode-bias operation .....	0.5 max	megohm

### Beam Power Unit as Gated-Beam Discriminator

#### MAXIMUM RATINGS (Design-Maximum Values):

Plate Supply Voltage .....	330 max	volts
Grid-No.2 (Accelerator-Grid) Voltage .....	110 max	volts
Peak Positive Grid-No.1 Voltage .....	60 max	volts
Average Cathode Current .....	13 max	mA

## SHARP-CUTOFF TWIN PENTODE

# 6J11

Duodecar type used for if-amplifier service in television receivers. Outline 8A, **Outlines** section. Tube requires duodecar twelve-contact socket and may be mounted in any position.

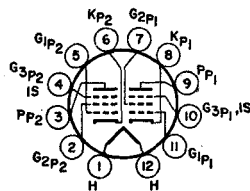

### 12BW

Heater Voltage (ac/dc) .....	6.3	volts
Heater Current .....	0.8	ampere
Peak Heater-Cathode Voltage:		
Heater negative with respect to cathode .....	200 max	volts
Heater positive with respect to cathode .....	200*max	volts
Direct Interelectrode Capacitances:**		
Unit No. 1:		
Grid No.1 to Cathode, Heater, Grid No.2, Grid No. 3, Grid No.3 of Unit No.2, and Internal Shield .....	11	pF
Plate to Cathode, Heater, Grid No.2, Grid No.3, Grid No. 3 of Unit No.2, and Internal Shield .....	2.8	pF
Unit No. 2:		
Grid No.1 to Cathode, Heater, Grid No.2, Grid No. 3, Grid No.3 of Unit No.1, and Internal Shield .....	11	pF
Plate to Cathode, Heater, Grid No.2, Grid No.3, Grid No.3 of Unit No.1, and Internal Shield .....	3.2	pF
Grid No.1 to Plate (Each Unit) .....	0.04 max	pF
Cathode of Unit No.1 to Cathode of Unit No.2 .....	0.02 max	pF
Grid No.1 of Unit No.1 to Plate of Unit No.2 .....	0.003 max	pF
Grid No.1 of Unit No.2 to Plate of Unit No.1 .....	0.003 max	pF
Plate of Unit No.1 to Plate of Unit No.2 .....	0.03 max	pF

- \* The dc component must not exceed 100 volts.
- \*\* With external shield connected to cathode.

**Class A<sub>1</sub> Amplifier (Each Unit)**

**MAXIMUM RATINGS (Design-Maximum Values):**

Plate Voltage .....	330 max	volts
Grid-No.2 (Screen-Grid) Supply Voltage .....	330 max	volts
Grid-No.2 Voltage .....	See curve page 80	
Grid-No.1 (Control-Grid) Voltage, Positive-bias value .....	0 max	volts
Plate Dissipation .....	3.1 max	watts
Grid-No.2 Input:		
For Grid No.2 Voltages up to 165 volts .....	0.65 max	watt
For Grid No.2 Voltages between 165 and 300 volts .....	See curve page 80	

**CHARACTERISTICS:**

Plate Supply Voltage .....	125	volts
Grid No.3 (Suppressor Grid) .....	Connected to cathode at socket	
Grid-No.2 Voltage .....	125	volts
Cathode-Bias Resistor .....	56	ohms
Plate Resistance (Approx.) .....	0.2	megohm
Transconductance .....	13000	μmhos
Plate Current .....	11	mA
Grid-No.2 Current .....	3.8	mA
Grid-No.1 Voltage (Approx.) for plate current of 20 μA .....	-3	volts

**MAXIMUM CIRCUIT VALUES:**

Grid-No.1-Circuit Resistance:		
For cathode-bias operation .....	0.25	megohm

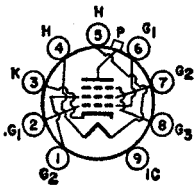

9QL

**BEAM POWER TUBE**

Novar types used as high-efficiency horizontal-deflection-amplifier tubes in television receivers. Outlines 18A and 32, respectively, **Outlines** section. Tubes require novar nine-contact socket and may be mounted in any

**6JB6  
6JB6A**

Related types:  
12JB6, 12JB6A,  
17JB6, 17JB6A

position. Types 12JB6 and 12JB6A and types 17JB6 and 17JB6A are identical with types 6JB6 and 6JB6A except for the heater ratings, as shown below.

	6JB6 6JB6A	12JB6 12JB6A	17JB6 17JB6A	
Heater Voltage (ac/dc) .....	6.3	12.6	16.8	volts
Heater Current .....	1.2	0.6	0.45	ampere
Heater Warm-up Time (Average) .....	—	11	11	seconds
Peak Heater-Cathode Voltage:				
Heater negative with respect to cathode ..	200 max	200 max	200 max	volts
Heater positive with respect to cathode ..	200 max	200 max	200 max	volts
Direct Interelectrode Capacitances (Approx.):				
Grid No.1 to Plate .....			0.2	pF
Grid No.1 to Cathode, Heater, Grid No.2, and Grid No.3 .....			15	pF
Plate to Cathode, Heater, Grid No.2, and Grid No.3 .....			6	pF

- \* The dc component must not exceed 100 volts.

**Class A<sub>1</sub> Amplifier**

**CHARACTERISTICS:**

	Triode Connection <sup>A</sup>	Pentode Connection	
Plate Voltage .....	150	60 150	volts
Grid No.3 (Suppressor Grid) .....	—	Connected to cathode at socket	
Grid No.2 (Screen-Grid) Voltage .....	—	150	volts
Grid No.1 (Control-Grid) Voltage .....	-22.5	0 -22.5	volts
Mu-Factor, Grid No.2 to Grid No.1 .....	4.4	—	
Plate Resistance (Approx.) .....	—	15000	ohms
Transconductance .....	—	7100	μmhos
Plate Current .....	—	390□ 70	mA

	Triode Connection <sup>▲</sup>	Pentode Connection	
Grid-No.2 Current .....	—	32□ 2.1	mA
Grid-No.1 Voltage for plate current of 1 mA ..	—	— —42	volts

<sup>▲</sup> Grid No.2 connected to plate.

□ This value can be measured by a method involving a recurrent waveform such that the maximum ratings of the tube will not be exceeded.

### Horizontal-Deflection Amplifier

For operation in a 525-line, 30-frame system

#### MAXIMUM RATINGS (Design-Maximum Values):

DC Plate Supply Voltage .....	770 max	volts
Peak Positive-Pulse Plate Voltage# .....	6500 max	volts
Peak Negative-Pulse Plate Voltage .....	-1500 max	volts
DC Grid-No.3 Voltage† .....	70 max	volts
DC Grid-No.2 Voltage .....	220 max	volts
DC Grid-No.1 Voltage .....	-55 max	volts
Peak Negative-Pulse Grid-No.1 Voltage .....	-330 max	volts
Peak Cathode Current .....	550 max	mA
Average Cathode Current .....	175 max	mA
Plate Dissipation* .....	17.5 max	watts
Grid-No.2 Input .....	3.5 max	watts
Bulb Temperature (At hottest point) .....	240 max	°C

#### MAXIMUM CIRCUIT VALUES:

Grid-No.1-Circuit Resistance:

For grid-resistor-bias operation ..... 1 max megohm

# The duration of the voltage pulse must not exceed 15 per cent of one horizontal scanning cycle. In a 525-line, 30-frame system, 15 per cent of one horizontal scanning cycle is 10 microseconds.

† For horizontal-deflection service, a positive voltage may be applied to grid No.3 to minimize "snivets" interference in both vhf and uhf television receivers. A typical value for this purpose is 30 volts.

\* An adequate bias resistor or other means is required to protect the tube in the absence of excitation.

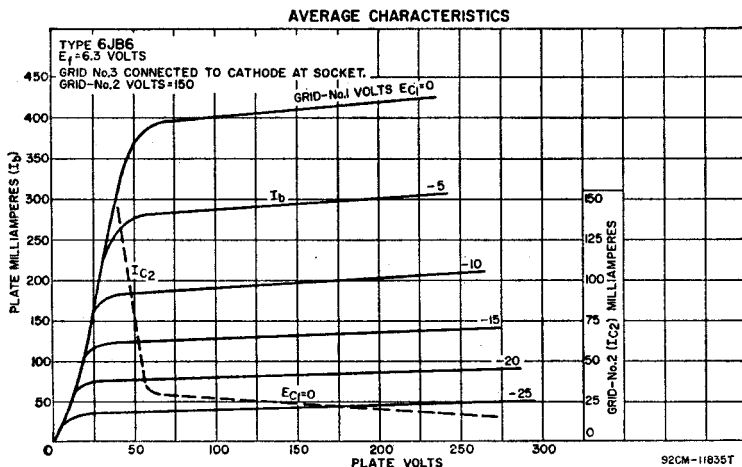

### SHARP-CUTOFF PENTODE

Miniature type with frame grid used in if-amplifier stages of television receivers utilizing intermediate frequencies in the order of 40 megacycles. Tube features high transconductance at low B-supply voltages. Outline 6B,

## 6JC6

Related types:  
3JC6, 4JC6

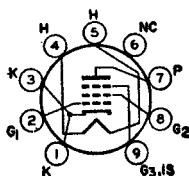

9PM



**Outlines** section. Tube requires miniature nine-contact socket and may be mounted in any position. Types 3JC6 and 4JC6 are identical with type 6JC6 except for the heater ratings, as shown below.

	3JC6	4JC6	6JC6	
Heater Voltage (ac/dc)	3.5	4.5	6.3	volts
Heater Current	0.6	0.45	0.3	ampere
Heater Warm-up Time (Average)	11	11	—	seconds
<b>Peak Heater-Cathode Voltage:</b>				
Heater negative with respect to cathode	200 max	200 max	200 max	volts
Heater positive with respect to cathode	200*max	200*max	200*max	volts
<b>Direct Interelectrode Capacitances:</b>				
Grid No.1 to Plate			0.019 max	pF
Grid No.1 to Cathode, Heater, Grid No.2, Grid No.3, and Internal Shield			8.2	pF
Plate to Cathode, Heater, Grid No.2, Grid No.3, and Internal Shield			3	pF

\* The dc component must not exceed 100 volts.

### Class A<sub>1</sub> Amplifier

#### MAXIMUM RATINGS (Design-Maximum Values):

Plate Voltage	330 max	volts
Grid-No.3 (Suppressor-Grid) Voltage, Positive value	0 max	volts
Grid-No.2 (Screen-Grid) Supply Voltage	330 max	volts
Grid-No.2 Voltage	See curve page 80	
Grid-No.1 (Control-Grid) Voltage, Positive-bias value	0 max	volts
<b>Grid-No.2 Input:</b>		
For grid-No.2 voltages up to 165 volts	0.6 max	watt
For grid-No.2 voltages between 165 and 330 volts	See curve page 80	
Plate Dissipation	2.5 max	watts

#### CHARACTERISTICS:

Plate Supply Voltage	125	volts
Grid No.3	Connected to cathode at socket	
Grid-No.2 Supply Voltage	125	volts
Cathode-Bias Resistor	56	ohms
Plate Resistance (Approx.)	0.18	megohm
Transconductance	15000	$\mu$ mhos
Plate Current	13	mA
Grid-No.2 Current	3.2	mA
Grid-No.1 Voltage (Approx.) for plate current of 100 $\mu$ A	-3	volts

#### MAXIMUM CIRCUIT VALUES:

<b>Grid-No.1-Circuit Resistance:</b>		
For fixed-bias operation	0.25 max	megohm
For cathode-bias operation	1 max	megohm

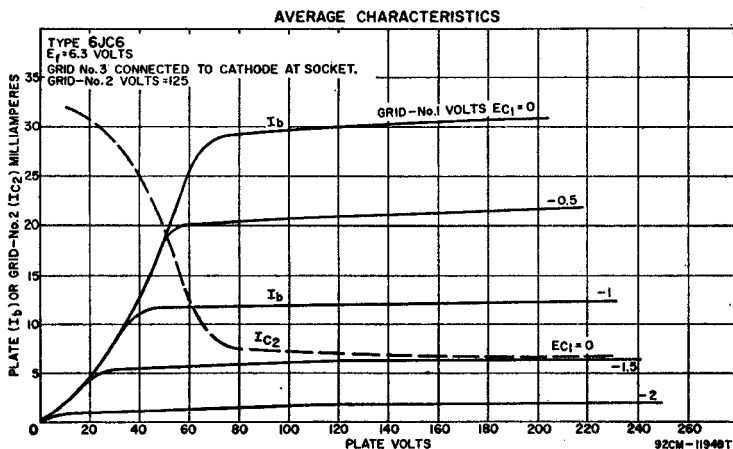

### MEDIUM-MU TRIODE— SHARP-CUTOFF PENTODE

## 6JC8

Miniature type used as combined vhf oscillator and mixer tube in television receivers employing series-connected heater strings. Outline 6B, **Outlines** section. Tube requires miniature nine-contact socket and may be mounted

in any position. Heater volts (ac/dc), 6.3; amperes, 0.45; warm-up time (average), 11 seconds; peak heater-cathode volts, 200 (the dc component must not exceed 100 volts when the heater is positive with respect to the cathode).

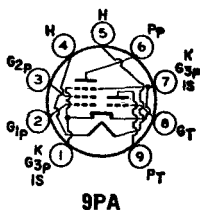

#### Class A<sub>1</sub> Amplifier

##### MAXIMUM RATINGS (Design-Maximum Values):

	Triode Unit	Pentode Unit	
Plate Voltage	275 max	275 max	volts
Grid-No.2 (Screen-Grid) Supply Voltage	—	275 max	volts
Grid-No.2 Voltage	—	See curve page 80	
Grid-No.1 (Control-Grid) Voltage, Positive-bias value	0 max	0 max	volts
Plate Dissipation	1.7 max	2.3 max	watts
Grid-No.2 Input:			
For grid-No.2 voltages up to 137.5 volts	—	0.45 max	watt
For grid-No.2 voltages between 137.5 and 275 volts	—	See curve page 80	

##### CHARACTERISTICS:

Plate Voltage	125	100	125	volts
Grid-No.2 Voltage	—	70	125	volts
Grid-No.1 Voltage	-1	0	-1	volt
Amplification Factor	40	—	—	
Plate Resistance (Approx.)	6000	—	300000	ohms
Transconductance	6500	5700	5500	μmhos
Plate Current	12	—	9	mA
Grid-No.2 Current	—	—	2.2	mA
Grid-No.1 Voltage (Approx.) for plate current of 20 μA	-7	—	6.5	volts

##### MAXIMUM CIRCUIT VALUES:

Grid-No.1-Circuit Resistance:			
For fixed-bias operation	—	0.1 max	megohm
For cathode-bias operation	—	0.5 max	megohm

### SHARP-CUTOFF PENTODE

## 6JD6

Related types:  
3JD6, 4JD6

Miniature type used as if-amplifier tube in television receivers utilizing an intermediate frequency in the order of 40 megacycles. Outline 6B, **Outlines** section. Tube requires miniature nine-contact socket and may be

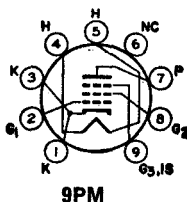

mounted in any position. Types 3JD6 and 4JD6 are identical with type 6JD6 except for the heater ratings, as shown below.

	3JD6	4JD6	6JD6	
Heater Voltage (ac/dc)	3.5	4.5	6.3	volts
Heater Current	0.6	0.45	0.3	ampere
Heater Warm-up Time (Average)	11	11	—	seconds
Peak Heater-Cathode Voltage:				
Heater negative with respect to cathode	200 max	200 max	200 max	volts
Heater positive with respect to cathode	200*max	200*max	200*max	volts
Direct Interelectrode Capacitances:				
Grid No.1 to Plate			0.019 max	pF
Grid No.1 to Cathode, Heater, Grid No.2, Grid No.3, and Internal Shield			8.2	pF
Plate to Cathode, Heater, Grid No.2, Grid No.3, and Internal Shield			3	pF

\* The dc component must not exceed 100 volts.

**Class A<sub>1</sub> Amplifier**

**MAXIMUM RATINGS (Design-Maximum Values):**

Plate Voltage .....	330 max	volts
Grid-No.3 (Suppressor-Grid) Voltage, Positive value .....	0 max	volts
Grid-No.2 (Screen-Grid) Supply Voltage .....	330 max	volts
Grid-No.2 Voltage .....	See curve page 80	
Grid-No.1 (Control-Grid) Voltage, Positive-bias value .....	0 max	volts
Grid-No.2 Input:		
For grid-No.2 voltages up to 165 volts .....	0.6 max	watts
For grid-No.2 voltages between 165 and 330 volts .....	See curve page 80	
Plate Dissipation .....	2.5 max	watts

**CHARACTERISTICS:**

Plate Supply Voltage .....	125	volts
Grid-No.3 Voltage .....	0	volts
Grid-No.2 Supply Voltage .....	125	volts
Grid-No.1 Supply Voltage .....	0	volts
Cathode-Bias Resistor .....	56	ohms
Plate Resistance (Approx.) .....	160000	ohms
Transconductance .....	14000	$\mu$ mhos
Plate Current .....	15	mA
Grid-No.2 Current .....	4	mA
Grid-No.1 Voltage (Approx.) for transconductance of 600 $\mu$ mhos ..	-4.5	volts

**MAXIMUM CIRCUIT VALUES:**

Grid-No.1-Circuit Resistance:		
For fixed-bias operation .....	0.25 max	megohm
For cathode-bias operation .....	1 max	megohm

**AVERAGE CHARACTERISTICS**

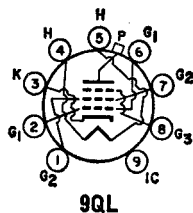
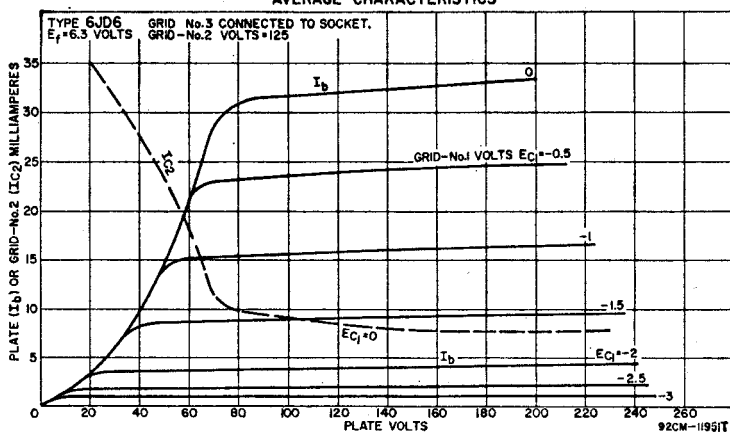

**BEAM POWER TUBE**

Novar type used as horizontal-deflection-amplifier tube in color television receivers. Outline 32A, **Outlines** section. Tube requires novar nine-contact socket and may be mounted in any position.

**6JE6A**

Heater Voltage (ac/dc) .....	6.3	volts
Heater Current .....	2.5	amperes
Peak Heater-Cathode Voltage:		
Heater negative with respect to cathode .....	200 max	volts
Heater positive with respect to cathode .....	200*max	volts

Direct Interelectrode Capacitances (Approx.):

Grid No.1 to Plate .....	0.56	pF
Grid No.1 to Cathode, Heater, Grid No.2, and Grid No.3 .....	22	pF
Plate to Cathode, Heater, Grid No.2, and Grid No.3 .....	11	pF

\* The dc component must not exceed 100 volts.

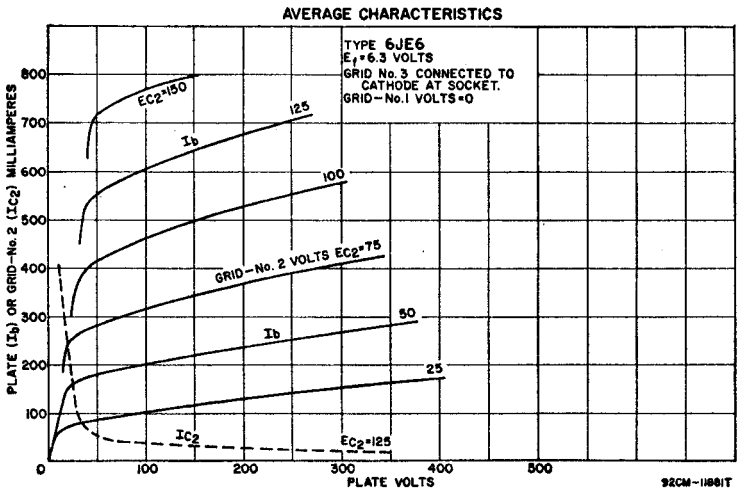
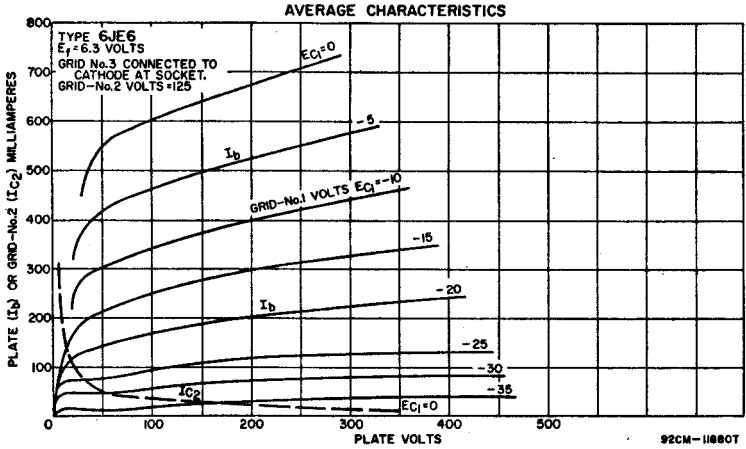

Class A<sub>1</sub> Amplifier

CHARACTERISTICS:

Plate Voltage .....	Triode Connection <sup>A</sup>	Pentode Connection	
Grid No.3 (Suppressor Grid) .....	125	70 175	volts
Grid-No.2 (Screen-Grid) Voltage .....	—	Connected to cathode at socket	
Grid-No.1 (Control-Grid) Voltage .....	—	125 125	volts
Amplification Factor .....	-25	0 -25	volts
Plate Resistance (Approx.) .....	3	— —	
Transconductance .....	—	— —	ohms
			μmhos

	Triode Connection <sup>▲</sup>	Pentode Connection	
Plate Current .....	—	600† 130	mA
Grid-No.2 Current .....	—	36† 2.8	mA
Grid-No.1 Voltage (Approx.) for plate current of 1 mA	—	— -54	volts

† This value can be measured by a method involving a recurrent waveform such that the maximum ratings of the tube will not be exceeded.

▲ Grid No.2 connected to plate.

### Horizontal-Deflection Amplifier

For operation in a 525-line, 30-frame system

#### MAXIMUM RATINGS (Design-Maximum Values):

DC Plate Supply Voltage .....	990 max	volts
Peak Positive-Pulse Plate Voltage <sup>■</sup> .....	7500 max	volts
Peak Negative-Pulse Plate Voltage .....	-1100 max	volts
DC Grid-No.3 Voltage <sup>■</sup> .....	75 max	volts
DC Grid-No.2 Voltage .....	220 max	volts
Peak Negative-Pulse Grid-No.1 Voltage .....	-330 max	volts
Peak Cathode Current .....	1200 max	mA
Average Cathode Current .....	350 max	mA
Grid-No.2 Input .....	3.2 max	watts
Plate Dissipation <sup>□</sup> .....	30 max	watts
Bulb Temperature (At hottest point) .....	250 max	°C

#### MAXIMUM CIRCUIT VALUES:

Grid-No.1-Circuit Resistance:	
For grid-resistor-bias operation <sup>□</sup> .....	0.47 max megohm
For plate-pulsed operation (horizontal-deflection circuits only) ..	10 max megohms

■ The duration of the voltage pulse must not exceed 15 per cent of one horizontal scanning cycle. In a 525-line, 30-frame system, 15 per cent of one horizontal scanning cycle is 10 microseconds.

• In this service, a positive voltage may be applied to grid No.3 to minimize "snivets" interference; a typical value for this voltage is 30 volts.

□ An adequate bias resistor or other means is required to protect the tube in the absence of excitation.

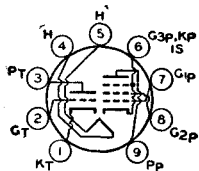

9DX

### HIGH-MU TRIODE— SHARP-CUTOFF PENTODE

Miniature type used in television receivers. The triode unit is used as a voltage amplifier or sync separator, and the pentode unit as a video amplifier. Outline 6E, Outlines section.

**6JE8**

Related type:  
11JE8

Tube requires miniature nine-contact

socket and may be mounted in any position. Type 11JE8 is identical with type 6JE8 except for heater ratings, as shown below.

	6JE8	11JE8	
Heater Voltage (ac/dc) .....	6.3	10.9	volts
Heater Current .....	0.78	0.45	ampere
Heater Warm-up Time (Average) .....	—	11	seconds
Peak Heater-Cathode Voltage:			
Heater negative with respect to cathode .....	200 max	200 max	volts
Heater positive with respect to cathode .....	200*max	200*max	volts

• The dc component must not exceed 100 volts.

### Class A<sub>1</sub> Amplifier

#### MAXIMUM RATINGS (Design-Maximum Values):

	Triode Unit	Pentode Unit	
Plate Voltage .....	300 max	330 max	volts
Grid-No.2 (Screen-Grid) Supply Voltage .....	—	330 max	volts
Grid-No.2 Voltage .....	—	See curve page 80	
Grid-No.1 (Control-Grid) Voltage Positive-bias value ..	0 max	0 max	volts
Plate Dissipation .....	1 max	5 max	watts
Grid-No.2 Input:			
For plate voltages up to 165 volts .....	—	1.5*max	watts
For plate voltages between 165 and 330 volts .....	—	See curve page 80	

**CHARACTERISTICS:**

	Triode Unit	Pentode Unit		
Plate Voltage .....	200	60	250	volts
Grid-No.2 Voltage .....	—	170	170	volts
Grid-No.1 Voltage .....	-2	0	—	volts
Cathode-Bias Resistor .....	—	—	82	ohms
Amplification Factor .....	70	—	—	
Plate Resistance (Approx.) .....	—	—	0.14	megohm
Transconductance .....	4200	—	12000	$\mu$ mhos
Plate Current .....	4.5	48*	22	mA
Grid-No.2 Current .....	—	12*	4	mA
Grid-No.1 Voltage (Approx.) for plate current of 10 $\mu$ A .....	-5	—	-10	volts

**MAXIMUM CIRCUIT VALUES:****Grid-No.1-Circuit Resistance:**

For fixed-bias operation .....	0.5 max	0.25 max	megohm
For cathode bias operation .....	1 max	1 max	megohm

\* Grid-No.2 input may reach 2 watts for plate-dissipation values of 4 watts or less.

# This value may be measured by a method involving a recurrent waveform such that the maximum ratings of the tube will not be exceeded.

**BEAM POWER TUBE****6JG6A**

Related types:  
17JG6A, 22JG6A

Novar type used as horizontal-deflection amplifier tube in low-B, black-and-white television receivers. Outline 31B, **Outlines** section. Tube requires novar nine-contact socket and may be mounted in any position. Types

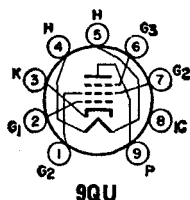

17JG6A and 22JG6A are identical with type 6JG6A except for heater ratings, as shown below.

	6JG6A	17JG6A	22JG6A	
Heater Voltage (ac/dc) .....	6.3	16.8	22	volts
Heater Current .....	1.6	0.6	0.45	amperes
Heater Warm-up Time (Average) .....	—	11	11	seconds
Peak Heater-Cathode Voltage:				
Heater negative with respect to cathode .....			200 max	volts
Heater positive with respect to cathode .....			200#max	volts
Direct Interelectrode Capacitances:				
Grid No.1 to Plate .....			0.7	pF
Grid No.1 to Cathode, Heater, Grid No.2, and Grid No.3 .....			22	pF
Plate to Cathode, Heater, Grid No.2, and Grid No.3 .....			9	pF

# The dc component must not exceed 100 volts.

**Class A<sub>1</sub> Amplifier****CHARACTERISTICS:**

	Triode Connection	Pentode Connection		
Plate Voltage .....	125	50	130	volts
Grid No.3 (Suppressor Grid) .....	—	Connected to cathode at socket		
Grid-No.2 (Screen-Grid) Voltage .....	—	125	125	volts
Grid-No.1 (Control-Grid) Voltage .....	-20	0	-20	volts
Amplification Factor .....	4.1	—	—	
Plate Resistance (Approx.) .....	—	—	12000	ohms
Transconductance .....	—	—	10000	$\mu$ mhos
Plate Current .....	—	525*	80	mA
Grid-No.2 Current .....	—	32*	2.5	mA
Grid-No.1 Voltage (Approx.), for plate current of 1 mA .....	—	—	-40	volts

\* With grid No.2 connected to plate at socket.

# This value can be measured by a method involving a recurrent waveform such that the maximum ratings of the tube will not be exceeded.

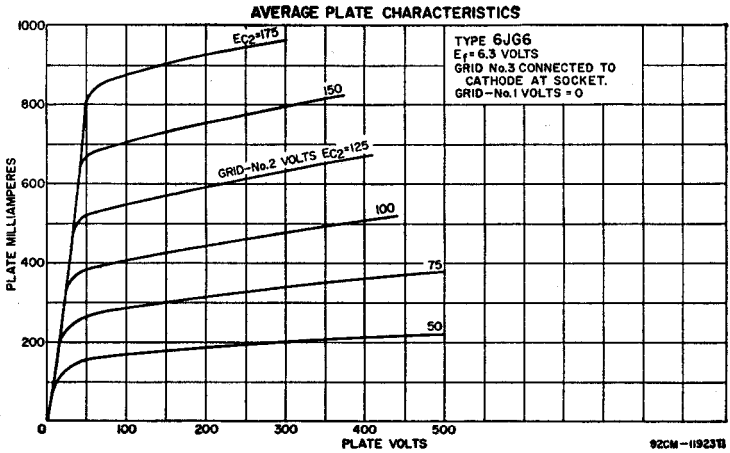
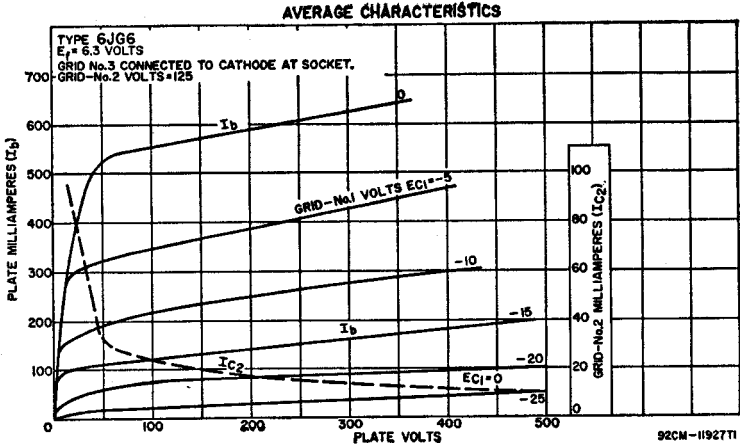

**Horizontal-Deflection Amplifier**

For operation in a 525-line, 30-frame system

**MAXIMUM RATINGS (Design-Maximum Values):**

DC Plate Supply Voltage	770 max	volts
Peak Positive-Pulse Plate Voltage <sup>□</sup>	6500 max	volts
Peak Negative-Pulse Plate Voltage	-1500 max	volts
DC Grid-No.3 Voltage*	75 max	volts
DC Grid-No.2 Voltage	220 max	volts
DC Grid-No.1 Voltage, Negative-bias value	-55 max	volts
Peak Negative-Pulse Grid-No.1 Voltage	-330 max	volts
Peak Cathode Current	950 max	mA
Average Cathode Current	275 max	mA
Plate Dissipation†	17 max	watts
Grid-No.2 Input	3.5 max	watts
Bulb Temperature (At hottest point)	240 max	°C

**MAXIMUM CIRCUIT VALUES:**

Grid-No.1 Circuit Resistance:

For grid-No.1-resistor-bias operation ..... 2.2 max megohms

□ The duration of the voltage pulse must not exceed 15 per cent of one horizontal scanning cycle. In a 525-line, 30-frame system, 15 per cent of one horizontal scanning cycle is 10 microseconds.

• In a horizontal-deflection-amplifier service, a positive voltage (typical value, 30 volts) may be applied to grid No.3 to reduce "snivets" interference, which may occur in both vhf and uhf television receivers.

† An adequate bias resistor or other means is required to protect the tube in the absence of excitation.

**SEMIREMOTE-CUTOFF PENTODE**

**6JH6**

Miniature type used in the gain-controlled picture if-amplifier stages of television receivers. Outline 5C, Outlines section. Tube requires miniature seven-contact socket and may be mounted in any position. For curves

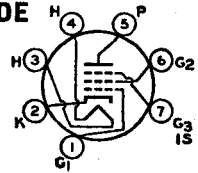

7CM

of average plate characteristics, refer to type 6BZ6.

Heater Voltage (ac/dc) .....	6.3	volts
Heater Current .....	0.3	ampere
<b>Peak Heater-Cathode Voltage:</b>		
Heater negative with respect to cathode .....	200 max	volts
Heater positive with respect to cathode .....	200*max	volts
<b>Direct Interelectrode Capacitances:</b>		
Grid No.1 to Plate .....	Without External Shield 0.025 max	With External Shield□ 0.015 max
Grid No.1 to Cathode, Heater, Grid No.2, Grid No.3, and Internal Shield .....	7	7
Plate to Cathode, Heater, Grid No.2, Grid No.3, and Internal Shield .....	2	3
		pF
		pF
		pF

• The dc component must not exceed 100 volts.

□ With external shield connected to cathode.

**Class A<sub>1</sub> Amplifier**

**MAXIMUM RATINGS (Design-Maximum Values):**

Plate Voltage .....	300 max	volts
Grid-No.3 (Suppressor-Grid) Voltage, Positive value .....	0 max	volts
Grid-No.2 (Screen-Grid) Supply Voltage .....	300 max	volts
Grid-No.2 Voltage .....	See curve page 80	
Grid-No.1 (Control-Grid) Voltage, Positive-bias value .....	0 max	volts
Grid-No.2 Input:		
For grid-No.2 voltages up to 150 volts .....	0.55 max	watt
For grid-No.2 voltages between 150 and 300 volts .....	See curve page 80	

**CHARACTERISTICS:**

Plate Supply Voltage .....	125	volts
Grid No.3 .....	Connected to cathode at socket	
Grid-No.2 Supply Voltage .....	125	volts
Cathode-Bias Resistor .....	56	ohms
Plate Resistance (Approx.) .....	0.26	megohm
Transconductance .....	8000	μmhos
Transconductance Range for grid-No.1 voltage of -4.5 volts and cathode-bias resistor of 56 ohms .....	400-900	μmhos
Grid-No.1 Voltage (Approx.) for transconductance of 50 μmhos and no cathode-bias resistor .....	-19	volts
Plate Current .....	14	mA
Grid-No.2 Current .....	3.6	mA

**MAXIMUM CIRCUIT VALUES:**

Grid-No.1-Circuit Resistance:

For fixed-bias operation ..... 0.25 max megohm  
For cathode-bias operation ..... 1 max megohm



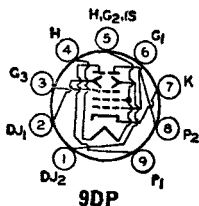

**BEAM-DEFLECTION TUBE**

Miniature type used in color-demodulator and burst-gate circuits in color television receivers. This type has two plates and two deflecting electrodes; the control grid varies beam deflection. Outline 6E, **Outlines** section.

**6JH8**

Tube requires miniature nine-contact socket and may be mounted in any position. Pin 5 should be connected to cathode at socket. The 6JH8 should be so located in the equipment that it is not subjected to stray magnetic fields. Heater volts (ac/dc), 6.3; amperes, 0.3.

**Color TV Demodulator**

**MAXIMUM RATINGS (Design-Maximum Values):**

Plate Voltage (Each Plate) .....	330 max	volts
Peak Deflecting-Electrode Voltage (Each Electrode):		
Negative value .....	-165 max	volts
Positive value .....	165 max	volts
Grid-No.3 (Accelerating-Grid) Voltage .....	330 max	volts
Grid-No.1 (Control-Grid) Voltage, Positive-bias value .....	0 max	volts
Cathode Current .....	33 max	mA
Plate Dissipation (Each Plate) .....	3 max	watts
Grid-No.3 Input .....	1 max	watt

**MAXIMUM CIRCUIT VALUES:**

Grid-No.1 Circuit Resistance:		
For fixed-bias operation .....	0.1 max	megohm
For cathode-bias operation .....	0.25 max	megohm

**Class A<sub>1</sub> Amplifier**

With both plates connected together and with both deflecting electrodes connected to cathode at socket

**CHARACTERISTICS:**

Plate-No.1 Supply Voltage .....	250	volts
Plate-No.2 Supply Voltage .....	250	volts
Grid-No.3 Voltage .....	250	volts
Cathode-Bias Resistor .....	220	ohms
Transconductance .....	4400	$\mu$ mhos
Total Plate Current .....	14	mA
Grid-No.3 Current .....	1.5	mA
Grid-No.1 Voltage (Approx.) for total plate current of 10 $\mu$ A .....	-13	volts

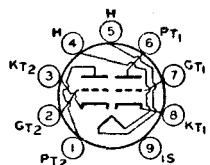

**DUAL TRIODE**

Miniature type used as combined rf-amplifier and mixer-oscillator tube in FM tuners. Unit No.1 is a medium-mu triode unit used as an oscillator-mixer, and unit No.2 is a high-mu triode unit used as an rf amplifier.

**6JK8**

Outline 6B, **Outlines** section. Tube requires miniature nine-contact socket and may be mounted in any position.

Heater Voltage (ac/dc) .....	6.3	volts
Heater Current .....	0.4	ampere
Peak Heater-Cathode Voltage:		
Heater negative with respect to cathode .....	100 max	volts
Heater positive with respect to cathode .....	100 max	volts

Direct Interelectrode Capacitances:	Unit No.1	Unit No.2	
Grid to Plate .....	1.4	0.6	pF
Grid to Cathode, Heater, and Internal Shield .....	3	5	pF
Plate to Cathode, Heater, and Internal Shield .....	1	4	pF
Heater to Cathode .....	2.8	2.8	pF
Grid of Unit No.1 to Grid of Unit No.2 .....		0.003 max	pF
Plate of Unit No.1 to Plate of Unit No.2 .....		0.009 max	pF

**Class A<sub>1</sub> Amplifier**

MAXIMUM RATINGS (Design-Maximum Values):	Unit No.1	Unit No.2	
Plate Voltage .....	165 max	200 max	volts
Negative Grid Voltage .....	-50 max	-50 max	volts
DC Cathode Current .....	22 max	22 max	mA
Plate Dissipation .....	1 max	2 max	watts

**CHARACTERISTICS:**

Plate Voltage .....	100	135	volts
Grid Voltage .....	-1	-1.2	volts
Amplification Factor .....	55	70	
Plate Resistance (Approx.) .....	8000	5400	ohms
Transconductance .....	6800	13000	μmhos
Plate Current .....	5.3	10	mA
Grid Voltage (Approx.):			
For plate current of 20 μA .....	-4.4	-	volts
For transconductance of 150 μmhos .....	-	-5.5	volts
For transconductance of 1500 μmhos .....	-	-2.8	volts

**MAXIMUM CIRCUIT VALUES:**

Grid-Circuit Resistance:			
For cathode-bias operation .....	1 max	1 max	megohm

**BEAM POWER TUBE**

**6JM6**

Related type:  
17JM6

Duodec type used as horizontal-amplifier tube in television receivers. Outline 16A, **Outlines** section. Tube requires duodec twelve-contact socket and may be mounted in any position.

Type 17JM6 is identical with type

6JM6 except for the heater ratings, as shown below.

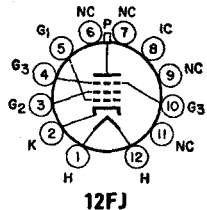

	6JM6	17JM6	
Heater Voltage (ac/dc) .....	6.3	16.8	volts
Heater Current .....	1.2	0.45	ampere
Heater Warm-up Time (Average) .....	-	11	seconds
Peak Heater-Cathode Voltage:			
Heater negative with respect to cathode .....	200 max	200 max	volts
Heater positive with respect to cathode .....	200†max	200†max	volts

† The dc component must not exceed 100 volts.

**Class A<sub>1</sub> Amplifier**

**CHARACTERISTICS:**

Plate Voltage .....	5000	60	250	volts
Grid-No.3 Suppressor-Grid .....			Connected to cathode at socket	
Grid-No.2 (Screen-Grid) Voltage .....	150	150	150	volts
Grid-No.1 (Control-Grid) Voltage .....	-	0	-22.5	volts
Plate Resistance (Approx.) .....	-	-	18000	ohms
Transconductance .....	-	-	7300	μmhos
Plate Current .....	-	345*	65	mA
Grid-No.2 Current .....	-	27*	1.8	mA
Grid-No.1 Voltage (Approx.) for plate current of 1 μA .....	-100	-	-42	volts
Triode Amplification Factor** .....	-	-	4.4	

\* This value can be measured by a method utilizing a recurrent waveform such that the maximum ratings of the tube will not be exceeded.

\*\* Triode connection (grid No.2 tied to plate); plate and grid-No.2 volts = 150, and grid-No.1 volts = -22.5.

**Class A<sub>1</sub> Amplifier**

**MAXIMUM CIRCUIT VALUES:**

Grid-No.1-Circuit Resistance .....	1 max megohm
------------------------------------	--------------

**Horizontal-Deflection Amplifier**

For operation in a 525-line, 30-frame system

**MAXIMUM RATINGS (Design-Maximum Values):**

DC Plate Supply Voltage .....	770 max	volts
Peak Positive-Pulse Plate Voltage# .....	6500 max	volts
Peak Negative-Pulse Plate Voltage .....	-1500 max	volts
DC Grid-No. 3 Voltage .....	70 max	volts
DC Grid-No.2 Voltage .....	220 max	volts
DC Grid-No.1 Voltage, Negative-bias value .....	-55 max	volts
Peak Negative-Pulse Grid-No.1 Voltage .....	-330 max	volts
Average Cathode Current .....	175 max	mA
Peak Cathode Current .....	550 max	mA
Plate Dissipation## .....	17.5 max	watts
Grid-No.2 Input .....	3.5 max	watts
Bulb Temperature (At hottest point) .....	220 max	°C

# The duration of the voltage pulse must not exceed 15 per cent of one horizontal scanning cycle. In a 525-line, 30-frame system, 15 per cent of one horizontal scanning cycle is 10 microseconds.

## An adequate bias resistor or other means is required to protect the tube in the absence of excitation.

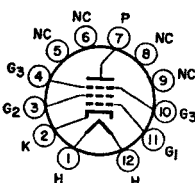

**BEAM POWER TUBE**

Duodecax type used as horizontal-amplifier tube in television receivers. Outline 15A, **Outlines** section. Tube requires duodecax twelve-contact socket and may be mounted in any position.

**6JN6**

**Related types:**  
12JN6, 17JN6

**12FK**

type 6JN6 except that it has a slightly lower grid-No.1 to plate capacitance. Types 12JN6 and 17JN6 are identical with type 6JN6 except for heater ratings, as shown below.

Heater Voltage (ac/dc) .....	6JN6	12JN6	17JN6	
Heater Current .....	6.3	12.6	16.8	volts
Heater Warm-up Time (Average) .....	1.2	0.6	0.45	ampere
	—	11	11	seconds

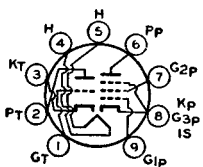

**MEDIUM-MU TRIODE—  
SHARP-CUTOFF PENTODE**

Miniature type used as FM converter and rf-amplifier tube in radio receivers employing series-connected heater strings. Outline 6B, **Outlines** section. Tube requires miniature nine-contact socket and may be mounted in any position.

**6JN8**

**Related types:**  
12JN8, 19JN8

Types 12JN8 and 19JN8 are identical with type 6JN8 except for heater ratings, as shown below.

Heater Voltage (ac/dc) .....	6JN8	12JN8	19JN8	
Heater Current .....	6.3	12.6	18.9	volts
Heater Warm-up Time (Average) .....	0.45	0.225	0.15	ampere
Peak Heater-Cathode Voltage:	11	—	—	seconds
Heater negative with respect to cathode ..	200 max	200 max	200 max	volts
Heater positive with respect to cathode ..	200•max	200•max	200•max	volts

Direct Interelectrode Capacitances:\*

Pentode Unit:

Grid No.1 to Plate .....	0.01	pF
Grid No.1 to Cathode, Heater, Grid No.2, Grid No.3, and Internal Shield .....	5.5	pF
Plate to Cathode, Heater, Grid No.2, Grid No.3, and Internal Shield .....	3.4	pF

Triode Unit:

Grid to Plate .....	1.7	pF
Grid to Cathode, Heater, Pentode Cathode, Grid No.3, and Internal Shield .....	3.2	pF
Plate to Cathode, Heater, Pentode Cathode, Grid No.3, and Internal Shield .....	2.2	pF

- The dc component must not exceed 100 volts.
- \* With external shield connected to cathode of unit under test.

Class A<sub>1</sub> Amplifier

MAXIMUM RATINGS (Design-Maximum Values):

	Triode Unit	Pentode Unit	
Plate Voltage .....	300 max	300 max	volts
Grid-No.2 (Screen-Grid) Supply Voltage .....	—	300 max	volts
Grid-No.2 Voltage .....	—	See curve page 80	
Grid-No.1 (Control-Grid) Voltage, Positive-bias value .....	0 max	0 max	volts
Plate Dissipation .....	2.5 max	2.5 max	watts
Grid-No.2 Input:			
For grid-No.2 voltages up to 150 volts .....	—	0.55 max	watt
For grid-No.2 voltages between 150 and 300 volts .....	—	See curve page 80	

CHARACTERISTICS:

Plate Voltage .....	125	125	volts
Grid-No.2 Voltage .....	—	125	volts
Grid-No.1 Voltage .....	-1	-1	volt
Amplification Factor .....	46	—	
Plate Resistance (Approx.) .....	5400	200000	ohms
Transconductance .....	8500	7500	μmhos
Plate Current .....	13.5	12	mA
Grid-No.2 Current .....	—	4	mA
Grid-No.1 Voltage (Approx.) for plate current of 10 μA .....	-8	-8	volts

MAXIMUM CIRCUIT VALUES:

Grid-No.1-Circuit Resistance:			
For fixed-bias operation .....	2.2 max	2.2 max	megohms
For cathode-bias operation .....	2.2 max	2.2 max	megohms

BEAM POWER TUBE

6JS6

Duodecar type used as horizontal-deflection amplifier in television receivers. Outline 16B, Outlines section. Tube requires duodecar twelve-contact socket and may be mounted in any position.

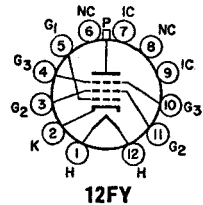

12FY

Heater Voltage (ac/dc) .....	6.3	volts
Heater Current .....	2.25	amperes
Peak Heater-Cathode Voltage:		
Heater negative with respect to cathode .....	200 max	volts
Heater positive with respect to cathode .....	200 max	volts
Direct Interelectrode Capacitances (Approx.):		
Grid No.1 to Plate .....	0.7	pF
Grid No.1 to Cathode, Heater, Grid No.2, and Grid No.3 .....	24	pF
Plate to Cathode, Heater, Grid No.2, and Grid No.3 .....	10	pF

- The dc component must not exceed 100 volts.

Class A<sub>1</sub> Amplifier

CHARACTERISTICS:

Plate Voltage .....	5000	70	175	volts
Grid No.3 (Suppressor Grid) .....	—	Connected to cathode at socket		
Grid-No.2 (Screen-Grid) Voltage .....	125	125	125	volts
Grid-No.1 (Control-Grid) Voltage .....	—	0	-25	volts
Plate Resistance (Approx.) .....	—	—	5600	ohms
Transconductance .....	—	—	11300	μmhos

Plate Current .....	—	570†	125	mA
Grid-No.2 Current .....	—	34†	4.5	mA
Grid-No.1 Voltage (Approx.) for plate current of 1 mA .....	-140	—	-54	volts
Triode Amplification Factor†† .....	—	—	3	

**MAXIMUM CIRCUIT VALUE:**

Grid-No.1 Circuit Resistance .....	1 max	megohm
------------------------------------	-------	--------

† These values can be measured by a method involving a recurrent waveform such that the plate dissipation and grid-No.2 input will not exceed their maximum ratings.

†† Triode connection (grid No.2 tied to plate).

**Horizontal-Deflection Amplifier**

For operation in a 525-line, 30-frame system

**MAXIMUM RATINGS (Design-Maximum Values):**

DC Plate Supply Voltage .....	990 max	volts
Peak Positive-Pulse Plate Voltage* .....	7500 max	volts
Peak Negative-Pulse Plate Voltage .....	1100 max	volts
DC Grid-No.3 Voltage .....	70 max	volts
DC Grid-No.2 Voltage .....	190 max	volts
Peak Negative-Pulse Grid-No.1 Voltage .....	-250 max	volts
Average Cathode Current .....	315 max	mA
Peak Cathode Current .....	1100 max	mA
Plate Dissipation** .....	28 max	watts
Grid-No.2 Input .....	5.5 max	watts
Bulb Temperature (At hottest point) .....	225 max	°C

\* The duration of the pulse must not exceed 15 per cent of one horizontal scanning cycle. In a 525-line, 30-frame system, 15 per cent of one horizontal scanning cycle is 10 microseconds.

\*\* An adequate bias resistor or other means is required to protect the tube in the absence of excitation.

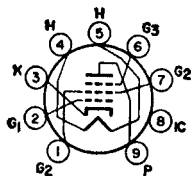

**BEAM POWER TUBE**

Novar types used as horizontal deflection amplifiers in high-efficiency deflection circuits of black-and-white television receivers employing wide-angle or high-voltage picture tubes.

Tubes require novar nine-contact

socket and may be mounted in any position. Outlines 17C and 31A, respectively, **Outlines** section. Types 12JT6 and 12JT6A and types 17JT6 and 17JT6A are identical with types 6JT6 and 6JT6A except for heater ratings, as shown below.

	6JT6	12JT6	17JT6	
	6JT6A	12JT6A	17JT6A	
Heater Voltage (ac/dc) .....	6.3	12.6	16.8	volts
Heater Current .....	1.2	0.6	0.45	amperes
Heater Warm-up Time (Average) .....	—	11	11	seconds
Peak Heater-Cathode Voltage:				
Heater negative with respect to cathode .....			200 max	volts
Heater positive with respect to cathode .....			200*max	volts
Direct Interelectrode Capacitances:				
Grid No.1 to Plate .....			0.26	pF
Grid No.1 to Cathode, Heater, Grid No.2, and Grid No.3 .....			15	pF
Plate to Cathode, Heater, Grid No.2, and Grid No.3 .....			6.5	pF

\* The dc component must not exceed 100 volts.

**Class A<sub>1</sub> Amplifier**

**CHARACTERISTICS:**

Plate Voltage .....	60	250	volts
Grid No.3 (Suppressor Grid) .....	Connected to cathode at socket		
Grid-No.2 (Screen-Grid) Voltage .....	150	150	volts
Grid-No.1 (Screen-Grid) Voltage .....	0	-22.5	volts
Triode Amplification Factor .....	—	4.4*	
Plate Resistance (Approx.) .....	—	15000	ohms

**6JT6  
6JT6A**

Related types:  
12JT6, 12JT6A,  
17JT6, 17JT6A

Transconductance .....	—	7100	μmhos
Plate Current .....	390*	70	mA
Grid-No.2 Current .....	32*	2.1	mA
Grid-No.1 Voltage (Approx.) for plate current of 1 mA	—	-42	volts

- \* Grid No.2 connected to plate; plate and grid-No.2 volts, 150; grid-No.1 volts, -22.5.
- \* This value can be measured by a method involving a recurrent waveform such that the maximum ratings of the tube will not be exceeded.

### Horizontal-Deflection Amplifier

For operation in a 525-line, 30-frame system

#### MAXIMUM RATINGS (Design-Maximum Values):

DC Plate Supply Voltage .....	770 max	volts
Peak Positive-Pulse Plate Voltage# .....	6500 max	volts
Peak Negative-Pulse Plate Voltage .....	-1500 max	volts
DC Grid-No.3 Voltage <sup>Δ</sup> .....	70 max	volts
DC Grid-No.2 Voltage .....	220 max	volts
DC Grid-No.1 Voltage, Negative-bias value .....	-55 max	volts
Peak Negative-Pulse Grid-No.1 Voltage .....	-330 max	volts
Peak Cathode Current .....	550 max	mA
Average Cathode Current .....	175 max	mA
Plate Dissipation† .....	17.5 max	watts
Grid-No.2 Input .....	3.5 max	watts
Bulb Temperature (At hottest point) .....	240 max	°C

#### MAXIMUM CIRCUIT VALUE:

Grid-No.1-Circuit Resistance:  
 For grid-resistor-bias operation ..... 1 max megohm

# The duration of the voltage pulse must not exceed 15 per cent of one horizontal scanning cycle. In a 525-line, 30-frame system, 15 per cent of one horizontal scanning cycle is 10 microseconds.

<sup>Δ</sup> A positive voltage may be applied to grid No.3 to reduce interference from "snivets" which may occur in television receivers. A typical value for this voltage is 30 volts.

† An adequate bias resistor or other means is required to protect the tube in the absence of excitation.

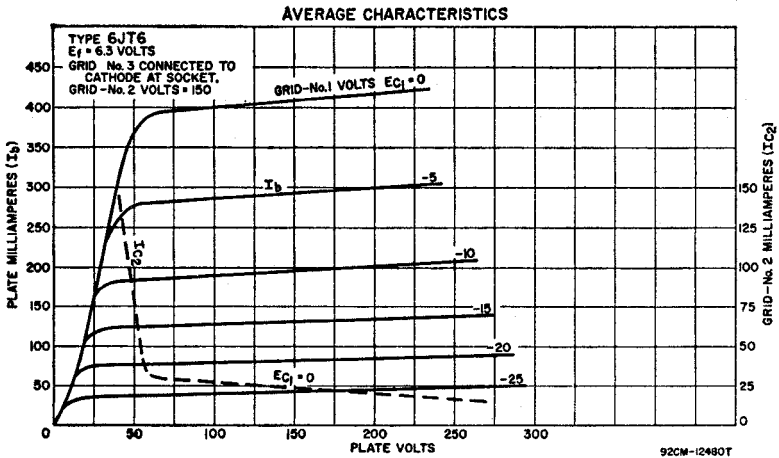

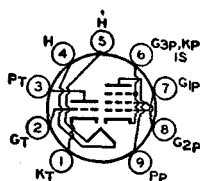

9DX

### HIGH-MU TRIODE— SHARP-CUTOFF PENTODE

Miniature type with frame-grid pentode unit used in television receivers. The triode unit is used as a voltage-amplifier or sync-separator tube, and the pentode unit is used as a video-amplifier tube. Outline 10A, **Outlines**

**6JT8**

section, except base is small-button miniature 9-pin. Tube requires miniature nine-contact socket and may be mounted in any position. Heater volts (ac/dc), 6.3; amperes, 0.725; peak heater-cathode volts, 200 (the dc component must not exceed 100 volts when the heater is positive with respect to the cathode).

#### Class A<sub>1</sub> Amplifier

#### MAXIMUM RATINGS (Design-Maximum Values):

	Triode Unit	Pentode Unit	
Plate Voltage	330 max	330 max	volts
Grid-No.2 (Screen-Grid) Supply Voltage	—	330 max	volts
Grid-No.2 Voltage	—	See curve page 80	
Grid-No.1 (Control-Grid) Voltage, Positive-bias value	0 max	0 max	volts
Plate Dissipation	1 max	4 max	watts
Grid-No.2 Input:			
For grid-No.2 voltages up to 165 volts	—	1.1 max	watts
For grid-No.2 voltages between 165 and 330 volts	—	See curve page 80	

#### CHARACTERISTICS:

Plate Supply Voltage	250	35	200	volts
Grid-No.2 Supply Voltage	—	100	100	volts
Grid-No.1 Voltage	—2	0	—	volts
Cathode-Bias Resistor	—	—	82	ohms
Amplification Factor	100	—	—	
Plate Resistance (Approx.)	37000	—	50000	ohms
Transconductance	2700	—	20000	μmhos
Plate Current	1.5	50*	17	mA
Grid-No.2 Current	—	17*	3.5	mA
Grid-No.1 Voltage (Approx.) for plate current of 100 μA	—	—	—5	volts
Grid-No.1 Voltage (Approx.) for plate current of 20 μA	—5.3	—	—	volts

#### MAXIMUM CIRCUIT VALUES:

Grid-No.1-Circuit Resistance:			
For fixed-bias operation	0.5 max	0.25 max	megohm
For cathode-bias operation	1 max	1 max	megohm

\* This value can be measured by a method involving a recurrent waveform such that the maximum ratings of the tube will not be exceeded.

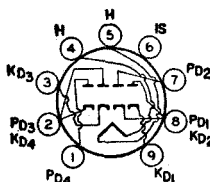

9PQ

### QUADRUPLE DIODE

Miniature types used in phase-detector and noise-immune, color-killer circuits of color television receivers; also used in bridge-matrixing circuits in FM stereo multiplex equipment. **Outlines 6E and 6B, respectively, Out-**

**6JU8**  
**6JU8A**

lines section. Units 1 and 2 are shielded from units 3 and 4 to minimize coupling between the series-connected pairs of diodes. Tube requires miniature nine-contact socket and may be mounted in any position.

Heater Voltage (ac/dc)	6.3	volts
Heater Current	0.6	ampere
Peak Heater-Cathode Voltage:		
Heater negative with respect to cathode	300 max	volts
Heater positive with respect to cathode	300 max	volts

## Direct Interelectrode Capacitances (Approx.):

Plate of Unit No.1 and Cathode of Unit No.2 to Cathode of Unit No.1	1.8	pF
Plate of Unit No.1 and Cathode of Unit No.2 to Plate of Unit No.2	2.2	pF
Plate of Unit No.2 to Heater and Internal Shield	0.62	pF
Plate of Unit No.3 and Cathode of Unit No.4 to Cathode of Unit No.3	1.9	pF
Plate of Unit No.3 and Cathode of Unit No.4 to Plate of Unit No.4	2.2	pF
Plate of Unit No.4 to Heater and Internal Shield	0.94	pF
Cathode of Unit No.1 to Heater and Internal Shield	1.8	pF
Cathode of Unit No.3 to Heater and Internal Shield	1.9	pF

## MAXIMUM RATINGS (Design-Maximum Values, Each Unit):

Peak Inverse Plate Voltage	300 max	volts
Peak Plate Current	54 max	volts
DC Output Current	9 max	mA

## CHARACTERISTICS, Instantaneous Value (Each Unit):

Plate Current for plate voltage of 10 volts	60	mA
---	----	----

### HIGH-MU TRIODE— SHARP-CUTOFF PENTODE

## 6JV8

Related type:  
8JV8

Miniature type used in a wide variety of applications in television receivers, particularly those having low-voltage "B" supplies and employing series-connected heater strings. The triode unit is used in sound-if, keyed-agc,

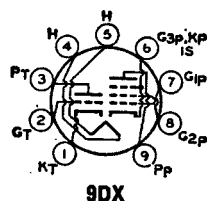

9DX

sync-separator, sync-amplifier, and noise-suppression circuits. The pentode unit is especially useful as a video amplifier tube. Outline 6E, Outlines section. Tube requires miniature nine-contact socket and may be mounted in any position. Type 8JV8 is identical with type 6JV8 except for the heater ratings, as shown below.

Heater Voltage (ac/dc)	6JV8 6.3	8JV8 8.5	volts
Heater Current	0.6	0.45	ampere
Heater Warm-up Time (Average)	11	11	seconds
Peak Heater-Cathode Voltage:			
Heater negative with respect to cathode	200 max	200 max	volts
Heater positive with respect to cathode	200•max	200•max	volts
Direct Interelectrode Capacitances (Approx.):			
Triode Unit:			
Grid to Plate		2.2	pF
Grid to Cathode and Heater		3	pF
Plate to Cathode and Heater		2	pF
Pentode Unit:			
Grid No.1 to Plate		0.08 max	pF
Grid No.1 to Cathode, Heater, Grid No.2, Grid No.3, and Internal Shield		8	pF
Plate to Cathode, Heater, Grid No.2, Grid No.3, and Internal Shield		3.2	pF
Pentode Grid No.1 to Triode Plate		0.012 max	pF
Pentode Plate to Triode Plate		0.24 max	pF

• The dc component must not exceed 100 volts.

### Class A<sub>1</sub> Amplifier

MAXIMUM RATINGS (Design-Maximum Values):	Triode Unit	Pentode Unit	
Plate Voltage	330 max	330 max	volts
Grid-No.2 (Screen-Grid) Voltage	—	330 max	volts
Grid-No.1 (Control-Grid) Voltage:			
Positive-bias value	0 max	0 max	volts
Negative-bias value	-50 max	-50 max	volts
Plate Dissipation	1.1 max	4 max	watts
Grid-No.2 Input	—	1.7 max	watts



AVERAGE PLATE CHARACTERISTICS  
TRIODE UNIT

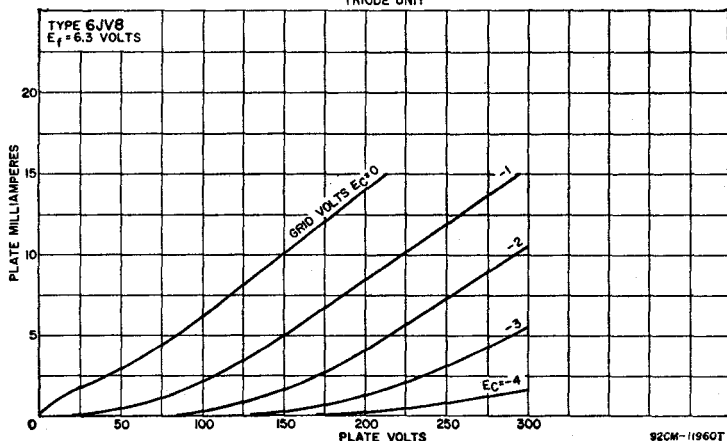

**CHARACTERISTICS:**

	Triode Unit	Pentode Unit			
Plate Voltage	200	60	125	200	volts
Grid-No.2 Voltage	—	200	125	200	volts
Grid-No.1 Voltage	-2	0	-1	-2.9	volts
Amplification Factor	70	—	—	—	
Plate Resistance (Approx.)	0.0175	—	0.1	0.15	megohm
Transconductance	4000	—	11500	10700	$\mu$ mhos
Plate Current	4	51*	22	22	mA
Grid-No.2 Current	—	14*	4	4	mA
Grid-No.1 Voltage (Approx.) for plate current of 20 $\mu$ A	-5	—	-5.5	-9	volts

**MAXIMUM CIRCUIT VALUES:**

Grid-No.1-Current Resistance:			
For fixed-bias operation		0.5 max	0.25 max megohm
For cathode-bias operation		1 max	1 max megohm

\* This value can be measured by a method involving a recurrent waveform such that the maximum ratings of the tube will not be exceeded.

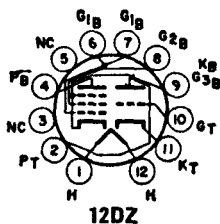

**MEDIUM-MU TRIODE—  
BEAM POWER TUBE**

Duodecar type used in combined vertical-deflection-oscillator and vertical-deflection-amplifier applications in television receivers. Outline 8B, Outlines section. Tube requires duodecar twelve-contact socket and may be

**6JZ8**

mounted in any position. Heater volts (ac/dc), 6.3; amperes, 1.2; peak heater-cathode volts, 200 (the dc component must not exceed 100 volts when heater is positive with respect to cathode).

**Class A<sub>1</sub> Amplifier**

	Triode Unit	Pentode Unit		
Plate Voltage	150	45	120	volts
Grid-No.2 (Screen-Grid) Voltage	—	110	110	volts
Grid-No.1 (Control-Grid) Voltage	-5	0	-8	volts
Amplification Factor	20	—	—	
Plate Resistance (Approx.)	8500	—	11700	ohms
Transconductance	2350	—	7100	$\mu$ mhos
Plate Current	5.5	122*	46	mA

	Triode Unit	Pentode Unit		
Grid-No.2 Current .....	—	16.5*	3.5	mA
Grid-No.1 Voltage (Approx.) for plate current of 10 $\mu$ A .....	-10	—	—	volts
Grid-No.1 Voltage (Approx.) for plate current of 100 $\mu$ A .....	—	—	-25	volts

\* This value can be measured by a method involving a recurrent waveform such that the maximum ratings of the tube will not be exceeded.

### Vertical Deflection Oscillator and Amplifier

For operation in a 525-line, 30-frame system

MAXIMUM RATINGS (Design-Maximum Values):	Triode Unit	Beam Power Unit		
	Oscillator	Amplifier		
DC Plate Voltage .....	250 max	250 max		volts
Peak Positive-Pulse Plate Voltage# .....	—	2000 max		volts
DC Grid-No.2 Voltage .....	—	200 max		volts
Peak Negative-Pulse Grid-No.1 Voltage .....	-400 max	-150 max		volts
Peak Cathode Current .....	70 max	245 max		mA
Average Cathode Current .....	20 max	70 max		mA
Plate Dissipation .....	1 max	7 max		watts
Grid-No.2 Input .....	—	1.8 max		watts

#### MAXIMUM CIRCUIT VALUES:

Grid-No.1-Circuit Resistance:			
For fixed-bias operation .....	1 max	1 max	megohm
For cathode-bias operation .....	2.2 max	2.2 max	megohms

# The duration of the voltage pulse must not exceed 15 per cent of one vertical scanning cycle. In a 525-line, 30-frame system, 15 per cent of one vertical scanning cycle is 2.5 milliseconds.

### POWER PENTODE

# 6K6GT

Glass octal type used in output stage of radio receivers and, triode-connected, as a vertical deflection amplifier in television receivers. It is capable of delivering moderate power output with relatively small input

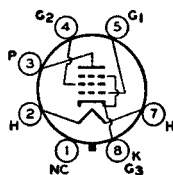

7S

voltage. Tube may be used singly or in push-pull. This type may be supplied with pin No.1 omitted. Tube requires octal socket and may be mounted in any position. Outline 13D, Outlines section. It is especially important that this tube, like other power-handling tubes, be adequately ventilated.

Heater Voltage (ac/dc) .....	6.3	volts
Heater Current .....	0.4	ampere
Peak Heater-Cathode Voltage:		
Heater negative with respect to cathode .....	200 max	volts
Heater positive with respect to cathode .....	200*max	volts
Direct Interelectrode Capacitances (Approx.):		
Grid No.1 to Plate .....	0.5	pF
Grid No.1 to Cathode, Heater, Grid No.2, and Grid No.3 .....	5.5	pF
Plate to Cathode, Heater, Grid No.2, and Grid No.3 .....	6.0	pF

\* The dc component must not exceed 100 volts.

### Class A<sub>1</sub> Amplifier

#### MAXIMUM RATINGS (Design-Center Values):

Plate Voltage .....	315 max	volts
Grid-No.2 (Screen-Grid) Voltage .....	285 max	volts
Plate Dissipation .....	8.5 max	watts
Grid-No.2 Input .....	2.8 max	watts

#### TYPICAL OPERATION:

Plate Voltage .....	100	250	315	volts
Grid-No.2 Voltage .....	100	250	250	volts
Grid-No.1 (Control-Grid) Voltage .....	-7	-18	-21	volts
Peak AF Grid-No.1 Voltage .....	7	18	21	volts
Zero-Signal Plate Current .....	9	32	25.5	mA

Maximum-Signal Plate Current	9.5	33	28	mA
Zero-Signal Grid-No.2 Current	1.6	5.5	4.0	mA
Maximum-Signal Grid-No.2 Current	3	10	9	mA
Plate Resistance (Approx.)	104000	90000	110000	ohms
Transconductance	1500	2300	2100	$\mu$ mhos
Load Resistance	12000	7600	9000	ohms
Total Harmonic Distortion	11	11	15	per cent
Maximum-Signal Power Output	0.35	3.4	4.5	watts

**TYPICAL PUSH-PULL OPERATION** (Values are for two tubes):

	Fixed Bias	Cathode Bias	
Plate Supply Voltage	285	285	volts
Grid-No.2 Supply Voltage	285	285	volts
Grid-No.1 Voltage	-25.5	-	volts
Cathode-Bias Resistor	-	400	ohms
Peak AF Grid-No.1-to-Grid-No.1 Voltage	51	51	volts
Zero-Signal Plate Current	55	55	mA
Maximum-Signal Plate Current	72	61	mA
Zero-Signal Grid-No.2 Current	9	9	mA
Maximum-Signal Grid-No.2 Current	17	13	mA
Effective Load Resistance (Plate-to-plate)	12000	12000	ohms
Total Harmonic Distortion	6	4	per cent
Maximum-Signal Power Output	10.5	9.8	watts

**CHARACTERISTICS** (Triode Connection)\*:

Plate Voltage	250	volts
Grid-No.1 Voltage	-18	volts
Plate Current	37.5	mA
Transconductance	2700	$\mu$ mhos
Amplification Factor	6.8	
Plate Resistance (Approx.)	2500	ohms
Grid-No.1 Voltage (Approx.) for plate current of 0.5 mA	-48	volts

**MAXIMUM CIRCUIT VALUES:**

Grid-No.1-Circuit Resistance:		
For fixed-bias operation	0.1 max	megohm
For cathode-bias operation	0.5 max	megohm

\* Grid-No.2 connected to plate.

**Vertical Deflection Amplifier (Triode Connection)\***

For operation in a 525-line, 30-frame system

**MAXIMUM RATINGS:**

DC Plate Voltage	315 max	volts
Peak Positive-Pulse Plate Voltage† (Absolute maximum)	1200* max	volts
Peak Negative-Pulse Grid-No.1 Voltage	-250 max	volts
Peak Cathode Current	75 max	mA
Average Cathode Current	25 max	mA
Plate Dissipation	7 max	watts

**MAXIMUM CIRCUIT VALUE:**

Grid-No.1-Circuit Resistance:	
For cathode-bias operation	2.2 max megohms

\* Grid No.2 connected to plate.

† The duration of the voltage pulse must not exceed 15 per cent of one vertical scanning cycle. In a 525-line, 30-frame system, 15 per cent of one vertical scanning cycle is 2.5 milliseconds.

\* Under no circumstances should this absolute value be exceeded.

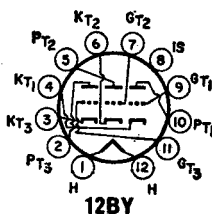

**THREE-UNIT TRIODE**

Duodecar type containing one medium-mu and two high-mu triode units used as combined agc, sync, and noise-inverter tube in television receivers employing series-connected heater strings. Outline 8A, Outlines section.

**6K11 / 6Q11**

Heater volts (ac/dc), 6.3; amperes, 0.6; warm-up time (average), 11 seconds; peak heater-cathode volts, 200 (the dc component must not exceed 100 volts when the heater is positive with respect to the cathode).

### Class A<sub>1</sub> Amplifier

MAXIMUM RATINGS (Design-Maximum Values):	Unit No.1	Units Nos. 2 and 3	
Plate Voltage .....	330 max	330 max	volts
Grid Voltage:			
Negative-bias value .....	-50 max	-50 max	volts
Positive-bias value .....	0 max	0 max	volts
Cathode Current .....	20 max	—	mA
Plate Dissipation .....	2.75 max	0.3 max	watts
<b>CHARACTERISTICS:</b>			
Plate Voltage .....	250	250	volts
Grid Voltage .....	-8.5	-2	volts
Amplification Factor .....	17	100	
Plate Resistance (Approx.) .....	7700	62500	ohms
Transconductance .....	2200	1600	μmhos
Plate Current .....	10.5	1.2	mA
Grid Voltage (Approx.) for plate current of 10 μA .....	-24	—	volts

### HIGH-MU TRIODE— SHARP-CUTOFF PENTODE

## 6KA8

Related type:  
8KA8

Miniature type used in color and black-and-white television receivers employing series-connected heater strings. The triode unit is used in sync-separator circuits; the pentode unit has two independent control

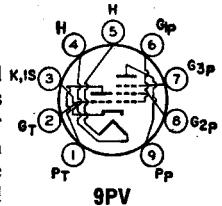

9PV

grids and is used in gated-agc-amplifier and noise-inverter circuits. Outline 6E, **Outlines** section. Tube requires miniature nine-contact socket and may be mounted in any position. For curves of average plate characteristics for triode unit, refer to type 6AW8A. Type 8KA8 is identical with type 6KA8 except for the heater ratings, as shown below.

	6KA8	8KA8	
Heater Voltage (ac/dc) .....	6.3	8.4	volts
Heater Current .....	0.6	0.45	ampere
Heater Warm-up Time (Average) .....	11	11	seconds
Peak Heater-Cathode Voltage:			
Heater negative with respect to cathode .....	200 max	200 max	volts
Heater positive with respect to cathode .....	200*max	200*max	volts
Direct Interelectrode Capacitances:			
Triode Unit:			
Grid to Plate .....		2.2	mA
Grid to Cathode, Heater, and Internal Shield .....		2.8	pF
Plate to Cathode, Heater, and Internal Shield .....		2.2	pF
Pentode Unit:			
Grid-No.1 to Plate .....		0.1 max	pF
Grid No.1 to Cathode, Heater, Grid No.2, Grid No.3, and Internal Shield .....		9.5	pF
Grid No.1 to Grid No.3 .....		0.5	pF
Grid No.3 to Plate .....		2.2	pF
Grid No.3 to All Other Electrodes, Heater, and Internal Shield ..		7	pF

\* The dc component must not exceed 100 volts.

### Class A<sub>1</sub> Amplifier

MAXIMUM RATINGS (Design-Maximum Values):	Triode Unit	
Plate Voltage .....	300 max	volts
Grid Voltage:		
Positive-bias value .....	0 max	volts
Negative-bias value .....	-50 max	volts
Plate Dissipation .....	1.1 max	watts

**CHARACTERISTICS:**

	Triode Unit	Pentode Unit	
Plate Supply Voltage	200	150	volts
Grid-No.3 Supply Voltage	—	0	volts
Grid-No.2 Supply Voltage	—	100	volts
Grid-No.1 Supply Voltage	-2	0	volts
Cathode-Bias Resistor	—	180	ohms
Amplification Factor	70	—	
Plate Resistance (Approx.)	17500	100000	ohms
Transconductance, Grid No.1 to Plate	4000	4400	$\mu$ mhos
Transconductance, Grid No.3 to Plate	—	600	$\mu$ mhos
Plate Current	4	4	mA
Grid-No.2 Current	—	2.8	mA
Grid-No.1 Supply Voltage (Approx.):			
For plate current of 10 $\mu$ A	-5	—	volts
For plate current of 20 $\mu$ A	—	-4	volts
Grid No.3 Supply Voltage (Approx.) for plate current of 20 $\mu$ A	—	-7	volts

**MAXIMUM CIRCUIT VALUES:**

Grid-Circuit Resistance:	Triode Unit	
For fixed-bias operation		0.25 max megohm
For cathode-bias operation		1 max megohm

**Gated AGC Amplifier and Noise Inverter**

**MAXIMUM RATINGS (Design-Maximum Values):**

	Pentode Unit	
DC Plate Voltage	300 max	volts
Peak Positive-Pulse Plate Voltage*	600 max	volts
Grid-No.3 (Control-Grid) Voltage:		
Positive-bias value	0 max	volts
Negative-bias value	-100 max	volts
Grid-No.2 (Screen-Grid) Supply Voltage	300 max	volts
Grid-No.2 Voltage	See curve page 80	
Grid-No.1 (Control-Grid) Voltage:		
Positive-bias value	0 max	volts
Negative-bias value	-50 max	volts
Plate Dissipation	2 max	watts
Grid-No.2 Input:		
For grid-No.2 voltages up to 150 volts	1.1 max	watts
For grid-No.2 voltages between 150 and 300 volts	See curve page 80	

\* The duration of the voltage pulse must not exceed 15 per cent of one horizontal scanning cycle. In a 525-line, 30-frame system, 15 per cent of one horizontal scanning cycle is 10 micro-seconds.

**MAXIMUM CIRCUIT VALUES:**

Grid-No.3-Circuit Resistance	0.68 max megohm
------------------------------	-----------------

**AVERAGE CHARACTERISTICS  
PENTODE UNIT**

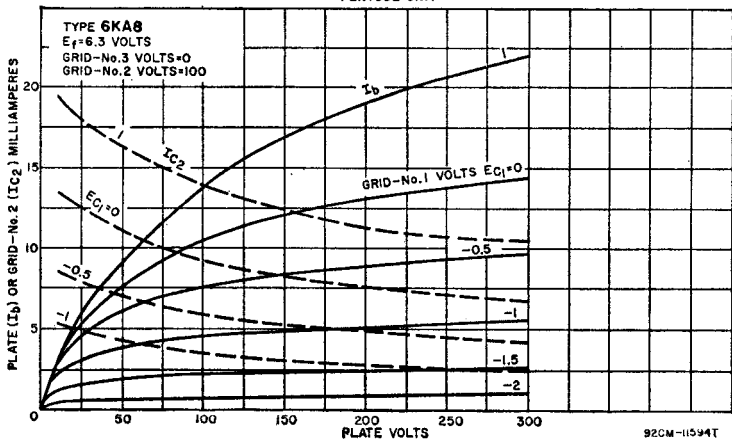

**Grid-No.1-Circuit Resistance:**

For fixed-bias operation .....  
 For cathode-bias operation .....

0.5 max megohm  
 1 max megohm

**AVERAGE CHARACTERISTICS  
 PENTODE UNIT**

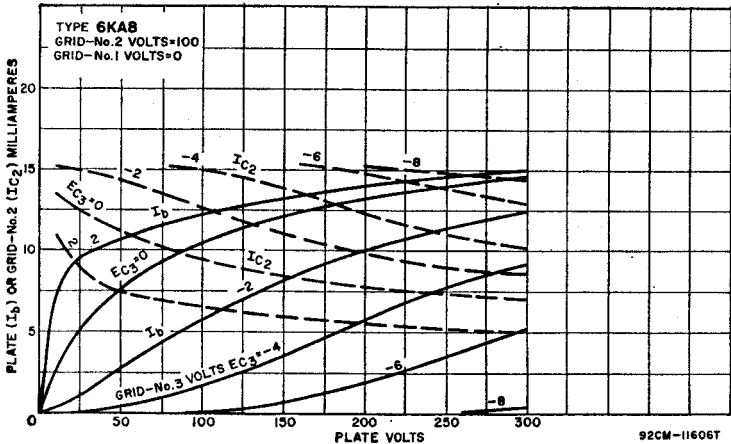

**MEDIUM-MU TRIODE  
 SHARP-CUTOFF PENTODE**

**6KD8**

Related type:  
 5KD8

Miniature type used as combined vhf oscillator and mixer tube in television receivers. Outline 6B, **Outlines** section. Tube requires miniature nine-contact socket and may be mounted in any position. Type 5KD8 is identical

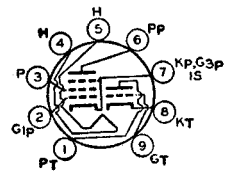

**9AE**

with type 6KD8 except for the heater ratings, as shown below.

	<b>5KD8</b>	<b>6KD8</b>	
Heater Voltage (ac/dc) .....	5.6	6.3	volts
Heater Current .....	0.45	0.4	ampere
Heater Warm-up Time .....	11	—	seconds
Peak Heater-Cathode Voltage:			
Heater negative with respect to cathode .....	200 max	200 max	volts
Heater positive with respect to cathode .....	200*max	200*max	volts

\* The dc component must not exceed 100 volts.

**Class A<sub>1</sub> Amplifier**

**MAXIMUM RATINGS (Design-Maximum Values):**

Plate Voltage .....	330 max
Grid-No.2 (Screen-Grid) Supply Voltage .....	—
Grid-No.2 Voltage .....	—
Grid-No.1 (Control-Grid) Voltage, Positive-bias value .....	0 max
Plate Dissipation .....	2.5 max
Grid-No.2 Input:	
For grid-No.2 voltages up to 165 volts .....	—
For grid-No.2 voltages between 165 and 330 volts .....	—

<b>Triode Unit</b>	<b>Pentode Unit</b>	
330 max	330 max	volts
—	330 max	volts
—	See curve page 80	
0 max	0 max	volts
2.5 max	3 max	watts
—	0.55 max	watt
—	See curve page 80	

**CHARACTERISTICS:**

Plate Voltage .....	125	125	volts
Grid-No.2 Voltage .....	—	110	volts
Grid-No.1 Voltage .....	—1	—1	volt
Amplification Factor .....	40	—	
Plate Resistance (Approx.) .....	—	0.2	megohm
Transconductance .....	7500	5000	μmhos
Plate Current .....	13.5	9.5	mA
Grid-No.2 Current .....	—	3.5	mA
Grid-No.1 Voltage (Approx.) for plate current of 20 μA .....	—9	—8	volts

**MAXIMUM CIRCUIT VALUES:**

Grid-No.1-Circuit Resistance:	
For fixed-bias operation .....	0.5 max megohm
For cathode-bias operation .....	1 max megohm

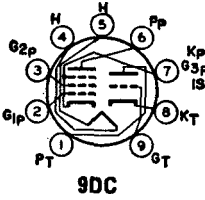

**MEDIUM-MU TRIODE—  
SHARP-CUTOFF PENTODE**

Miniature type with frame-grid pentode unit used as combined oscillator-mixer tube in television receivers using an intermediate frequency in the order of 40 megacycles. Outline 6B, Outlines section. Tube requires miniature nine-contact socket and may be mounted in any position. Type 5KE8 is identical with type 6KE8 except for the heater ratings, as shown below.

**6KE8**

Related type:  
5KE8

	5KE8	6KE8	
Heater Voltage (ac/dc) .....	5.6	6.3	volts
Heater Current .....	0.45	0.4	ampere
Heater Warm-up Time (Average) .....	11	—	seconds
Peak Heater-Cathode Voltage:			
Heater negative with respect to cathode .....	200 max	200 max	volts
Heater positive with respect to cathode .....	200*max	200*max	volts
Direct Interelectrode Capacitances: □			
Triode Unit:			
Grid to Plate .....		1.3	pF
Grid to Cathode, Heater, Pentode Cathode, Pentode Grid No.3, and Internal Shield .....		2.4	pF
Plate to Cathode, Heater, Pentode Cathode, Pentode Grid No.3, and Internal Shield .....		2	pF
Pentode Unit:			
Grid No.1 to Plate .....		0.015 max	pF
Grid No.1 to Cathode, Heater, Grid No.2, Grid No.3, and Internal Shield .....		5	pF
Plate to Cathode, Heater, Grid No.2, Grid No.3, and Internal Shield .....		3.4	pF
Heater to Triode Cathode and Pentode Cathode .....		5.5*	pF

- The dc component must not exceed 100 volts.
- With external shield connected to cathode of unit under test, except as noted.
- With external shield connected to ground.

**Class A<sub>1</sub> Amplifier**

<b>MAXIMUM RATINGS (Design-Maximum Values):</b>	Triode Unit	Pentode Unit	
Plate Voltage .....	280 max	280 max	volts
Grid-No.2 (Screen-Grid) Supply Voltage .....	—	280 max	volts
Grid-No.2 Voltage .....	—	See curve page 80	
Grid-No.1 (Control-Grid) Voltage, Positive-bias value .....	0 max	0 max	volts
Cathode Current .....	20 max	20 max	mA
Plate Dissipation .....	2 max	2 max	watts
Grid-No.2 Input:			
For grid-No.2 voltages up to 140 volts .....	—	0.5 max	watt
For grid-No.2 voltages between 140 and 280 volts .....	—	See curve page 80	

<b>CHARACTERISTICS:</b>	Triode Unit	Pentode Unit	
Plate Supply Voltage .....	125	125	volts
Grid-No.2 Supply Voltage .....	—	125	volts
Grid-No.1 Supply Voltage .....	0	0	volts
Cathode-Bias Resistor .....	68	33	ohms
Amplification Factor .....	40	—	
Plate Resistance (Approx.) .....	5000	125000	ohms
Transconductance .....	8000	12000	μmhos
Plate Current .....	13	10	mA
Grid-No.2 Current .....	—	2.8	mA
Grid-No.1 Voltage (Approx.):			
For plate current of 100 μA .....	5	—	volts
For plate current of 50 μA .....	—	—3	volts

**MAXIMUM CIRCUIT VALUES:**

Grid-No.1-Circuit Resistance:

For fixed-bias operation .....	0.5 max	0.25 max megohm
For cathode-bias operation .....	1 max	0.5 max megohm

**AVERAGE PLATE CHARACTERISTICS**  
TRIODE UNIT

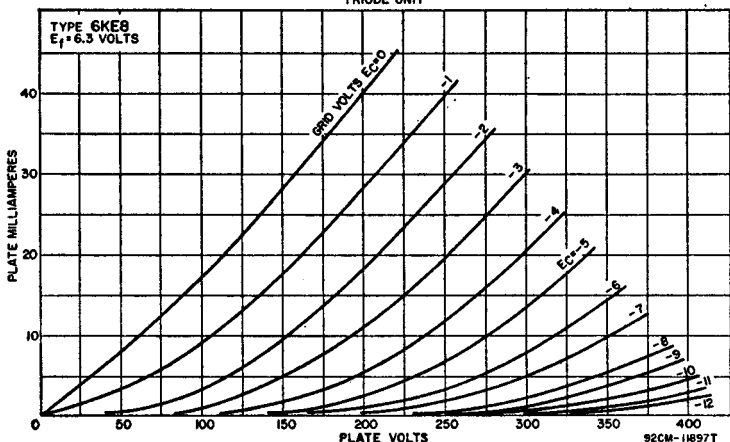

**AVERAGE CHARACTERISTICS**  
PENTODE UNIT

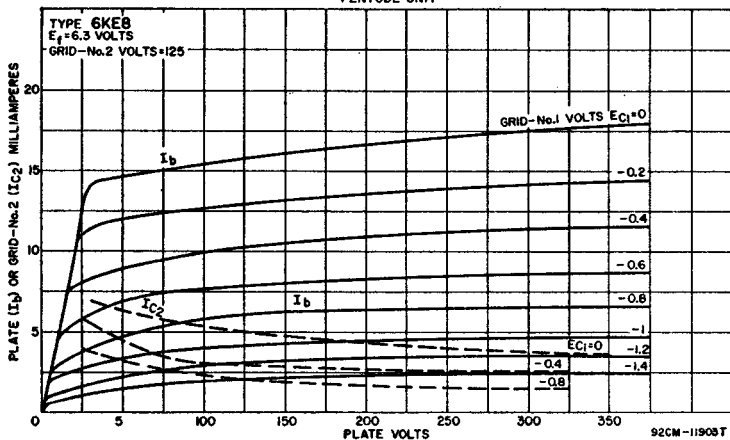

**BEAM POWER TUBE**

**6KM6**

Novar type used as horizontal-deflection amplifier in color television receivers. Outline 18A, **Outlines** section. Tube requires novar nine-contact socket and may be mounted in any position.

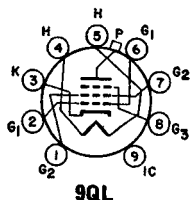



Heater Voltage (ac/dc) .....	6.3	volts
Heater Current .....	1.6	amperes
Peak Heater-Cathode Voltage:		
Heater positive with respect to cathode .....	200 max	volts
Heater negative with respect to cathode .....	200*max	volts
Direct Inter-electrode Capacitances:		
Grid No.1 to Plate .....	1.2	pF
Grid No.1 to Cathode, Heater, Grid No.2, and Grid No.3 .....	22	pF
Plate to Cathode, Heater, Grid No.2, and Grid No.3 .....	9	pF

\* The dc component must not exceed 100 volts.

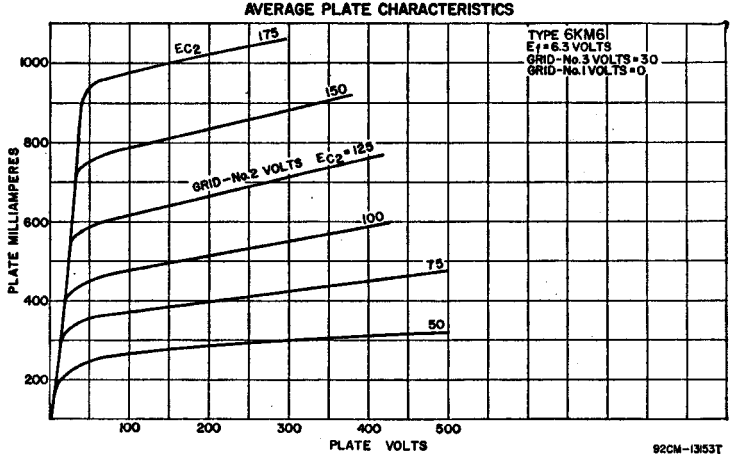

**Class A<sub>1</sub> Amplifier**

<b>MAXIMUM RATINGS</b> (Design-Maximum Values):	Triode Connection	Pentode Connection		
<b>CHARACTERISTICS:</b>				
Plate Voltage .....	140	—	60	140
Peak Positive-Pulse Plate Voltage** .....	—	6500	—	—
Grid-No.3 (Suppressor-Grid) Voltage .....	0	30	30	30
Grid-No.2 (Screen-Grid) Voltage .....	140	140	140	140
Grid-No.1 (Control-Grid) Voltage .....	-24.5	—	0	-24.5
Amplification Factor† .....	4	—	—	—
Plate Resistance (Approx.) .....	—	—	—	6000
Transconductance .....	—	—	—	9500
Plate Current .....	—	—	560††	80
Grid-No.2 Current .....	—	—	31††	2.4
Grid-No.1 Voltage for plate current of 1 mA .....	—	-110	—	-42

**Horizontal-Deflection Amplifier**

For operation in 525-line, 30-frame system

<b>MAXIMUM RATINGS</b> (Design-Maximum Values):		
DC Plate Supply Voltage .....	770 max	volts
Peak Positive-Pulse Plate Voltage** .....	6500 max	volts
Peak Negative-Pulse Plate Voltage .....	-1500 max	volts
DC Grid-No.3 Voltage .....	75 max	volts
DC Grid-No.2 Voltage .....	220 max	volts
Peak Negative-Pulse Grid-No.1 Voltage .....	-330 max	volts
Peak Cathode Current .....	950 max	mA
Average Cathode Current .....	275 max	mA
Grid-No.2 Input .....	3.5 max	watts
Plate Dissipation** .....	20 max	watts
Bulb Temperature (At hottest point) .....	240 max	°C

**MAXIMUM CIRCUIT VALUES:**

Grid-No.1-Circuit Resistance:

For grid-resistor-bias operation .....	0.47 max megohm
For plate-pulsed operation .....	10 max megohms

\*\* The duration of the cycle must not exceed 15 per cent of one horizontal scanning cycle. In a 525-line, 30-frame system, 15 per cent of the horizontal scanning cycle is 10 microseconds.

† With grid No.3 and grid No.2 connected, respectively, to cathode and plate at socket.

†† This value can be measured by a method involving a recurrent waveform such that the maximum ratings of the tube will not be exceeded.

■ In this service, a positive value may be applied to grid No.3 to minimize "snivets" interference; a typical value for this voltage is 30 volts.

■ ■ An adequate bias resistor or other means is required to protect the tube in the absence of excitation.

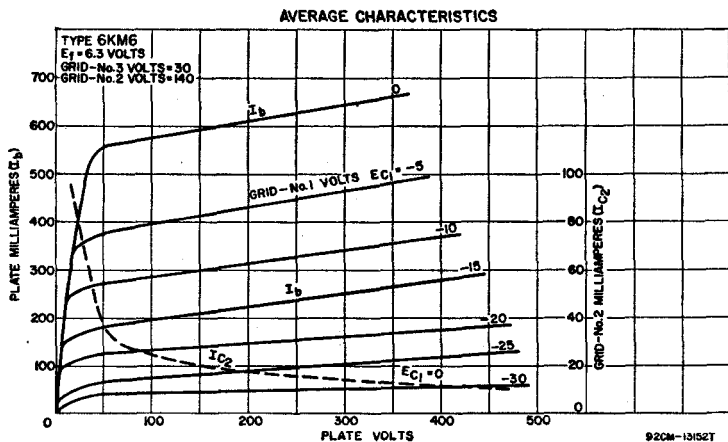

### DIODE— THREE-PLATE TETRODE

**6KM8**

Miniature type used in frequency-divider and complex-wave generator circuits of electronic musical instruments. In such circuits the tetrode unit can provide three independent output-signal voltages; the diode unit

can be used as a key in a vibrato circuit. Outline 6E, Outlines section. Tube requires miniature nine-contact socket and may be mounted in any position.

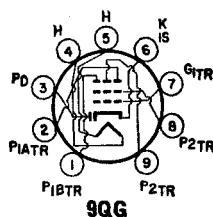

Heater Voltage (ac/dc) .....	6.3	volts
Heater Current .....	0.3	ampere
Peak Heater-Cathode Voltage:		
Heater negative with respect to cathode .....	200 max	volts
Heater positive with respect to cathode .....	200 max	volts
Direct Interelectrode Capacitances:		
Tetrode Unit:		
Grid No.1 to Plate No.1A .....	0.02 max	pF
Grid No.1 to Plate No.1B .....	0.02 max	pF
Grid No.1 to Plate No.2 .....	0.06 max	pF

Grid No.1 to Cathode, Heater, Grid No.2, and Internal Shield ..	5.5	pF
Plate No.1A to Cathode, Heater, Grid No.2, and Internal Shield	1.2	pF
Plate No.1B to Cathode, Heater, Grid No.2, and Internal Shield	1.3	pF
Plate No.2 to Cathode, Heater, Grid No.2, and Internal Shield ..	1.8	pF
Tetrode Grid No.1 to Diode Plate .....	0.024 max	pF
Tetrode Plate No.1A to Diode Plate .....	0.18	pF
Tetrode Plate No.1B to Diode Plate .....	0.024	pF
Tetrode Plate No.2 to Diode Plate .....	0.013	pF

• The dc component must not exceed 100 volts.

**Tetrode Unit as Class A<sub>1</sub> Amplifier**

Plates No. 1A, 1B, and 2 connected together

**CHARACTERISTICS:**

Plate Voltage .....	100	volts
Grid-No.2 Voltage .....	100	volts
Grid-No.1 Supply Voltage .....	0	volts
Grid-No.1 Resistor (Bypassed) .....	2.2	megohms
Plate Resistance (Approx.) .....	30000	ohms
Transconductance .....	3400	$\mu$ mhos
Plate Current .....	4.2	mA
Grid-No.2 Current .....	1.7	mA
Grid-No.1 Voltage (Approx.) for plate current of 20 $\mu$ A .....	-4	volts

Triode Connection—Plates No.1A, 1B, and 2 connected to grid No.2

**CHARACTERISTICS:**

Plate Voltage .....	100	volts
Grid-No.1 Supply Voltage .....	0	volts
Grid-No.1 Resistor (Bypassed) .....	2.2	megohms
Transconductance .....	4500	$\mu$ mhos
Amplification Factor .....	45	
Plate Current .....	5.5	mA

Separate plate operation; plates not under test grounded

Plate	1A	1B	2	
Plate Voltage .....	100	100	100	volts
Grid-No.2 Voltage .....	100	100	100	volts
Grid-No.1 Supply Voltage .....	0	0	0	volts
Grid-No.1 Resistor (Bypassed) .....	2.2	2.2	2.2	megohms
Transconductance .....	2000	2000	1800	$\mu$ mhos
Plate Resistance (Approx.) .....	0.1	0.1	0.12	megohm
Plate Current .....	2.3	2.3	2.1	mA
Grid-No.2 Current .....	3.8	3.8	3.3	mA

AVERAGE PLATE CHARACTERISTICS

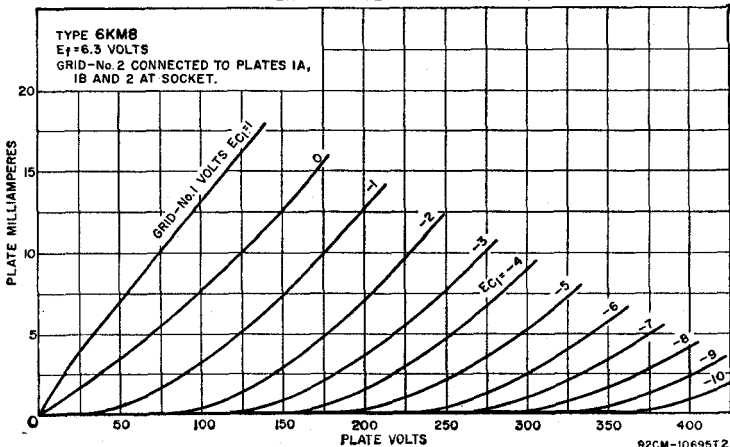

**Tetrode Unit as Frequency Divider and Complex-Wave Generator**

**MAXIMUM RATINGS (Design-Maximum Values):**

Plate Voltage (Each plate) .....	330 max	volts
Grid-No.2 (Screen-Grid) Supply Voltage .....	330 max	volts
Grid-No.2 Voltage .....	See curve page 80	
Grid-No.1 (Control-Grid) Voltage:		
Positive-bias value .....	0 max	volts
Negative-bias value .....	-50 max	volts
Grid-No.2 Input:		
For grid-No.2 voltages up to 165 volts .....	0.65 max	watt
For grid-No.2 voltages between 165 and 330 volts .....	See curve page 80	
Plate Dissipation (Each plate) .....	1 max	watt

**MAXIMUM CIRCUIT VALUES:**

Grid-No.1-Circuit Resistance:		
For grid-No.1-resistor-bias operation .....	2.2 max	megohms

**Diode Unit**

**MAXIMUM RATINGS (Design-Maximum Values):**

Plate Current .....	1 max	mA
---------------------	-------	----

**CHARACTERISTICS, Instantaneous Values:**

Tube Voltage Drop for plate current of 2 mA .....	10	volts
---	----	-------

**AVERAGE CHARACTERISTICS**

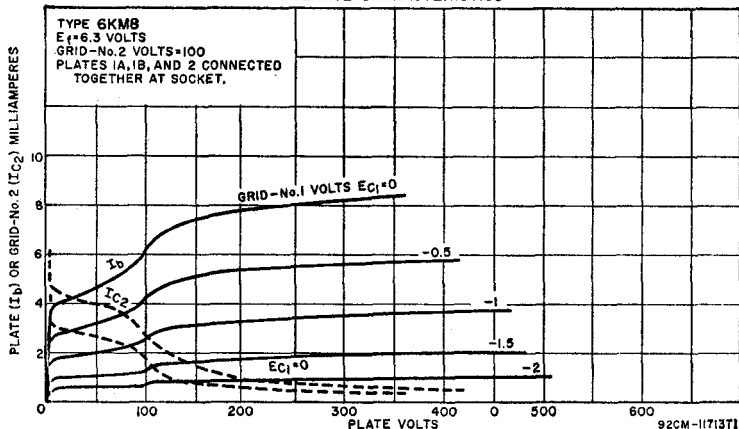

**MEDIUM-MU TRIODE—SHARP-CUTOFF PENTODE**

**6KR8**

Related type:  
10KR8

Miniature type used in a wide variety of applications in television receivers. The triode unit is used as a general-purpose amplifier; the pentode unit is used as a video amplifier. Outline 6E, **Outlines** section. Tube requires mini-

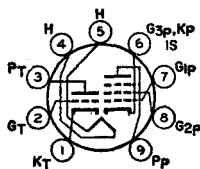

**9DX**

ature nine-contact socket and may be mounted in any position. Type 10KR8 is identical with type 6KR8 except for the heater ratings, as shown below.

	6KR8	10KR8	
Heater Voltage (ac/dc) .....	6.3	10.5	volts
Heater Current .....	0.75	0.45	ampere
Heater Warm-up Time (Average) .....	—	11	seconds
Peak Heater-Cathode Voltage:			
Heater negative with respect to cathode .....	200 max	200 max	volts
Heater positive with respect to cathode .....	200*max	200*max	volts

Direct Interelectrode Capacitances:

Triode Unit:		
Grid to Plate .....	2.6	pF
Grid to Triode Cathode, Pentode Cathode, Heater, Pentode Grid No.3, and Internal Shield .....	4.2	pF
Plate to Triode Cathode, Pentode Cathode, Heater, Pentode Grid No.3, and Internal Shield .....	3	pF
Pentode Unit:		
Grid No.1 to Plate .....	0.075	pF
Grid No.1 to Cathode, Heater, Grid No.2, Grid No.3, and Internal Shield .....	13	pF
Plate to Cathode, Heater, Grid No.2, Grid No.3, and Internal Shield .....	4.4	pF

\* The dc component must not exceed 100 volts.

**Class A<sub>1</sub> Amplifier**

**MAXIMUM RATINGS (Design-Maximum Values):**

	Triode Unit	Pentode Unit	
Plate Voltage .....	—	330 max	volts
Grid-No.2 (Screen-Grid) Supply Voltage .....	330 max	330 max	volts
Grid-No.2 Voltage .....	—	See curve page 80	
Grid-No.1 (Control-Grid) Voltage, Positive-bias value .....	0 max	0 max	volts
Plate Dissipation .....	2 max	5 max	watts
Grid-No.2 Input:			
For voltages up to 165 volts .....	—	1.1 max	watts
For voltages between 165 and 330 volts .....	—	See curve page 80	

**CHARACTERISTICS:**

Plate Supply Voltage .....	125	35	200	volts
Grid-No.2 Supply Voltage .....	—	100	100	volts
Grid-No.1 Voltage .....	—	0	—	volts
Cathode-Bias Resistor .....	68	—	82	ohms
Amplification Factor .....	46	—	—	
Plate Resistance (Approx.) .....	4400	—	6000	ohms
Transconductance .....	10400	—	20000	μmhos
Plate Current .....	15	54	19.5	mA
Grid-No.2 Current .....	—	13.5	3	mA
Grid-No.1 Voltage (Approx.) for plate current of 10 μA .....	—8	—	—	volts
Grid-No.1 Voltage (Approx.) for plate current of 100 μA .....	—	—	—6.3	volts

**MAXIMUM CIRCUIT VALUES:**

Grid-No.1 Circuit Resistance:

For fixed-bias operation .....	0.5 max	0.5 max	megohm
For cathode-bias operation .....	1.0 max	1.0 max	megohm

**HIGH-MU TRIODE—  
SHARP-CUTOFF PENTODE**

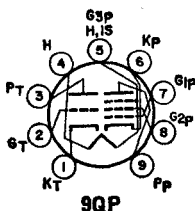

Miniature type used in a variety of applications in television receivers. The pentode unit is used as an if-amplifier tube, and the triode unit as a sync-separator or voltage-amplifier tube. Outline 6B, Outlines section.

**6KT8**

Tube requires miniature nine-contact socket and may be mounted in any position. Heater volts (ac/dc), 6.3; amperes, 0.6; peak heater-cathode volts, 200 (the dc component must not exceed 100 volts when the heater is positive with respect to the cathode)

**Class A<sub>1</sub> Amplifier**

**MAXIMUM RATINGS (Design-Maximum Values):**

	Triode Unit	Pentode Unit	
Plate Voltage .....	330 max	330 max	volts
Grid-No.2 (Screen-Grid) Supply Voltage .....	—	330 max	volts
Grid-No.2 Voltage .....	—	See curve page 80	
Grid-No.1 (Control-Grid) Voltage, Positive-bias value .....	0 max	0 max	volts
Plate Dissipation .....	1 max	2.5 max	watts

Grid-No.2 Input:			
For grid-No.2 voltages up to 165 volts	—	0.55 max	watt
For grid-No.2 voltages between 165 and 330 volts	—	See curve	page 80

**CHARACTERISTICS:**

Plate Voltage	250	125	volts
Grid-No.2 Voltage	—	125	volts
Grid-No.1 Voltage	-2	-1	volts
Amplification Factor	100	—	
Plate Resistance (Approx.)	31500	150000	ohms
Transconductance	3200	10000	μmhos
Plate Current	1.8	12	mA
Grid-No.2 Current	—	4.5	mA
Grid-No.1 Voltage (Approx.) for plate current of 20 μA	-3.5	-7	volts

**MAXIMUM CIRCUIT VALUES:**

Grid-No.1-Circuit Resistance:			
For fixed-bias operation	0.5 max	0.5 max	megohm
For cathode-bias operation	1 max	1 max	megohm

### TWIN DIODE— SHARP-CUTOFF PENTODE

**6KU8**

Related type:  
10KU8

Neonovial type with frame-grid pentode. Diode units are used as horizontal phase detectors and the pentode unit is used as a video amplifier. Outline 10A, **Outlines** section. Tube requires neonovial nine-contact socket

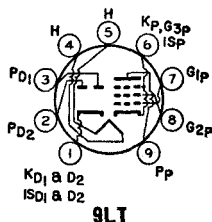

and may be mounted in any position. Type 10KU8 is identical with type 6KU8 except for heater ratings, as shown below.

	6KU8	10KU8	
Heater Voltage (ac/dc)	6.3	10.2	volts
Heater Current	0.725	0.45	ampere
Heater Warm-up Time (Average)	—	11	seconds
Peak Heater-Cathode Voltage:			
Heater negative with respect to cathode	200 max	200 max	volts
Heater positive with respect to cathode	200*max	200*max	volts
Direct Interelectrode Capacitances:			
Diode Units:			
Plate of Diode Unit No.1 to All Other Electrodes		1.1	pF
Plate of Diode Unit No.2 to All Other Electrodes		1.1	pF
Diode Cathode to Plate of Diode Unit No.1		5.5	pF
Diode Cathode to Plate of Diode Unit No.2		5.5	pF
Pentode Unit:			
Grid No.1 to Plate		0.1 max	pF
Grid No.1 to Pentode Cathode, Diode Cathode, Heater, Grid No.2, Grid No.3, and Internal Shields		12	pF
Plate to Pentode Cathode, Diode Cathode, Heater, Grid No.2, Grid No.3, and Internal Shields		3	pF
Pentode Grid No.1 to Plate of Diode Unit No.1		0.003 max	pF
Pentode Grid No.1 to Plate of Diode Unit No.2		0.003 max	pF
Pentode Plate to Plate of Diode Unit No.1		0.008 max	pF
Pentode Plate to Plate of Diode Unit No.2		0.008 max	pF

\* The dc component must not exceed 100 volts.

### Pentode Unit as Class A<sub>1</sub> Amplifier

**MAXIMUM RATINGS (Design-Maximum Values):**

Plate Voltage	330 max	volts
Grid-No.2 (Screen-Grid) Supply Voltage	330 max	volts
Grid-No.2 Voltage	See curve	page 80
Grid-No.1 (Control-Grid) Voltage, Positive-bias value	0 max	volts
Plate Dissipation	4 max	watts
Grid-No.2 Input:		
For voltages up to 165 volts	1.1 max	watts
For voltages between 165 and 330 volts	See curve	page 80

**CHARACTERISTICS:**

Plate Supply Voltage .....	50	200	volts
Grid-No.2 Supply Voltage .....	100	100	volts
Grid-No.1 Voltage .....	0	0	volts
Cathode-Bias Resistor .....	—	82	ohms
Transconductance .....	—	20000	μmhos
Plate Resistance (Approx.) .....	—	50000	ohms
Plate Current .....	55*	17	mA
Grid-No.2 Current .....	18*	3.5	mA
Grid-No.1 Voltage for plate current of 100 μA .....	—	-5	volts

**MAXIMUM CIRCUIT VALUES:**

Grid-No.1-Circuit Resistance:			
For fixed-bias operation .....		0.25 max	megohm
For cathode-bias operation .....		1 max	megohm

\* This value can be measured by a method involving a recurrent waveform such that the maximum ratings of the tube will not be exceeded.

**Diode Units (Each Unit)**

**CHARACTERISTICS, Instantaneous Value:**

Tube Voltage Drop for plate current of 2 mA .....	10	volts
---	----	-------

**HIGH-MU TRIODE—  
SHARP-CUTOFF PENTODE**

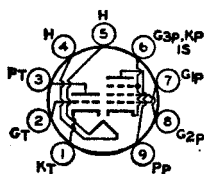

**9DX**

Miniature type with frame-grid pentode unit used in black-and-white television receivers. The triode unit is used in general-purpose voltage-amplifier, sync-separator, and sound-if-amplifier applications. The pentode

**6KV8**

Related type:  
11KV8

unit is used as a video output tube. Outline 6E, **Outlines** section. Tube requires miniature nine-contact socket and may be mounted in any position. For curves of average plate characteristics for triode unit, refer to type 6AW8A. Type 11KV8 is identical with type 6KV8 except for the heater ratings, as shown below.

	<b>6KV8</b>	<b>11KV8</b>	
Heater Voltage (ac/dc) .....	6.3	10.9	volts
Heater Current .....	0.775	0.45	ampere
Heater Warm-up Time (Average) .....	—	11	seconds
Peak Heater-Cathode Voltage:			
Heater negative with respect to cathode .....	200 max	200 max	volts
Heater positive with respect to cathode .....	200*max	200*max	volts
Direct Interelectrode Capacitances (Approx.):			
Triode Unit:			
Grid to Plate .....		3.7	pF
Grid to Cathode, Heater, Pentode Cathode, Pentode Grid No.3, and Internal Shield .....		2.5	pF
Plate to Cathode, Heater, Pentode Cathode, Pentode Grid No.3, and Internal Shield .....		2.4	pF
Triode Grid to Pentode Plate .....		0.015 max	
Pentode Unit:			
Grid No.1 to Plate .....		0.12 max	pF
Grid No.1 to Cathode, Heater, Grid No.2, Grid No.3, and Internal Shield .....		13	pF
Plate to Cathode, Heater, Grid No.2, Grid No.3, and Internal Shield .....		4.8	pF
Pentode Plate to Triode Plate .....		0.17 max	pF

\* The dc component must not exceed 100 volts.

**Class A<sub>1</sub> Amplifier**

**MAXIMUM RATINGS (Design-Maximum Values):**

Plate Voltage .....	300 max	300 max	volts
Grid-No.2 (Screen-Grid) Supply Voltage .....	—	300 max	volts
Grid-No.2 Voltage .....	—	See curve page 80	
Grid-No.1 (Control-Grid) Voltage, Positive-bias value .....	0 max	0 max	volts
Plate Dissipation .....	1 max	5 max	watts

	Triode Unit	Pentode Unit		
Grid-No.2 Input:				
For grid-No.2 voltages up to 150 volts	—	1 max	watt	
For grid-No.2 voltages between 150 and 300 volts	—	See curve page 80		
<b>CHARACTERISTICS:</b>				
Plate Supply Voltage	200	125	200	volts
Grid-No.2 Supply Voltage	—	125	125	volts
Grid-No.1 Supply Voltage	-2	0	0	volts
Cathode-Bias Resistor	—	82	68	ohms
Amplification Factor	70	—	—	
Plate Resistance (Approx.)	17500	55000	75000	ohms
Transconductance	4000	21000	23000	$\mu$ mhos
Plate Current	4	16.5	20	mA
Grid-No.2 Current	—	3.1	3.5	mA
Grid-No.1 Voltage (Approx.) for plate current of 100 $\mu$ A	-4.5	-4.2	-4.2	volts
<b>MAXIMUM CIRCUIT VALUES:</b>				
Grid-No.1-Circuit Resistance:				
For fixed-bias operation	0.5 max	0.1 max megohm		
For cathode-bias operation	1 max	0.25 max megohm		

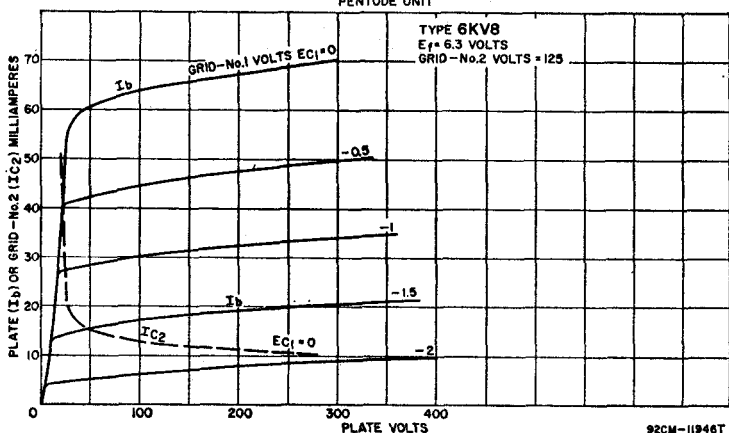
AVERAGE CHARACTERISTICS  
PENTODE UNITHIGH-MU TRIODE—  
BEAM POWER TUBE

**6KY8**  
**6KY8A**

Related types:  
15KY8, 15KY8A

Novar types used in combined vertical-deflection-oscillator and vertical-deflection-amplifier applications in black-and-white television receivers having low-voltage "B" supplies. Outlines 11C and 30A, respectively, Out-

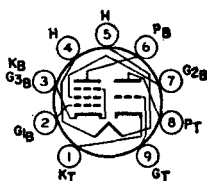

9QT

lines section. Tubes require novar nine-contact socket and may be mounted in any position. Types 15KY8 and 15KY8A are identical with types 6KY8 and 6KY8A, except for heater ratings, as shown below.

	6KY8 6KY8A	15KY8 15KY8A	
Heater Voltage (ac/dc)	6.3	15	volts
Heater Current	1.1	0.45	amperes
Heater Warm-up Time (Average)	—	11	seconds
Peak Heater-Cathode Voltage:			
Heater negative with respect to cathode	200 max	200 max	volts
Heater positive with respect to cathode	200*max	200*max	volts



Direct Interelectrode Capacitances (Approx.):

Triode Unit:		
Grid to Plate .....	0.44	pF
Grid to Cathode and Heater .....	15	pF
Plate to Cathode and Heater .....	7	pF
Pentode Unit:		
Grid No.1 to Plate .....	0.048	pF
Grid No.1 to Cathode, Heater, Grid No.2, and Grid No.3 .....	2.6	pF
Plate to Cathode, Heater, Grid No.2, and Grid No.3 .....	0.28	pF

• The dc component must not exceed 100 volts.

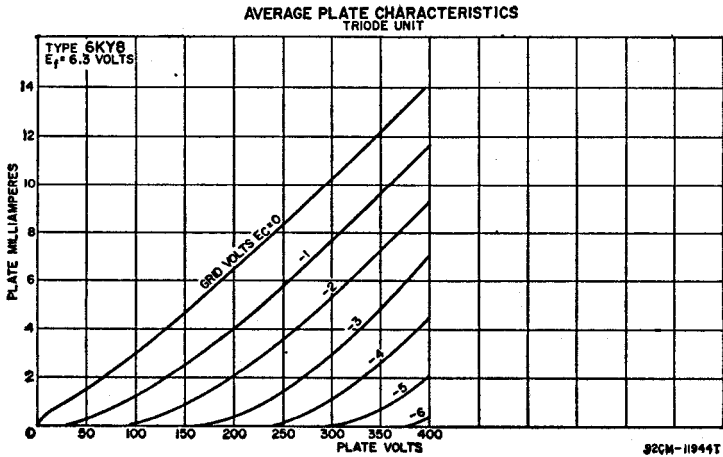
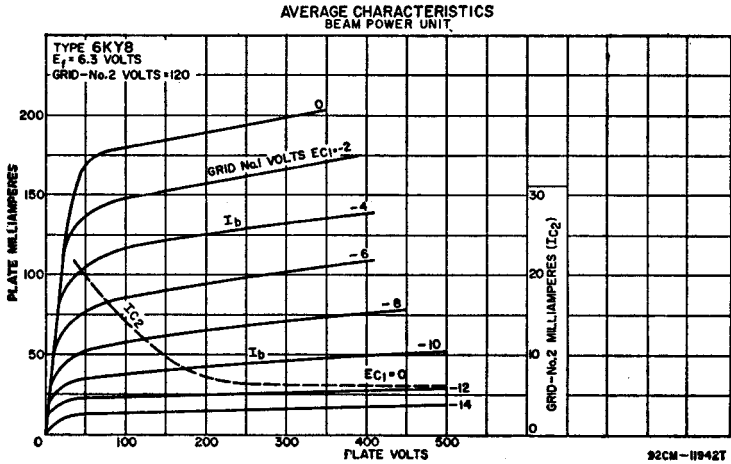

**Class A<sub>1</sub> Amplifier**

**CHARACTERISTICS:**

	Triode Unit	Beam Power Unit			
Plate Voltage .....	250	50	135	120	volts
Grid-No.2 (Screen-Grid) Voltage .....	—	120	120	*	volts
Grid-No.1 (Control-Grid) Voltage .....	-3	0	-10	-10	volts
Amplification Factor .....	64	—	—	7	

Plate Resistance (Approx.)	40000	—	18000	—	ohms
Transconductance	1600	—	8400	—	$\mu$ mhos
Plate Current	1.4	170*	39	—	mA
Grid-No.2 Current	—	20*	3	—	mA
Grid-No.1 Voltage (Approx.) for plate current of 1 mA	—	—	-24	—	volts

\* Triode connection, grid No.2 connected to plate at socket.

• This value can be measured by a method involving a recurrent waveform such that the maximum ratings of the tube will not be exceeded.

### Vertical-Deflection Oscillator and Amplifier

For operation in a 525-line, 30-frame system

MAXIMUM RATINGS (Design-Maximum Values):	Triode Unit	Beam Power Unit	volts
	Oscillator	Amplifier	
DC Plate Voltage	330 max	300 max	
Peak Positive-Pulse Plate Voltage# (Absolute Maximum)	—	2200†max	
DC Grid-No.2 Voltage	—	150 max	
Peak Negative-Pulse Grid-No.1 Voltage	-400 max	-250 max	
Peak Cathode Current	77 max	200 max	mA
Average Cathode Current	22 max	60 max	mA
Plate Dissipation	1.5 max	12 max	watts
Grid-No.2 Input	—	1.9 max	watts

#### MAXIMUM CIRCUIT VALUES:

Grid-No.1-Circuit Resistance:

For grid-resistor-bias operation 2.2 max 2.2 max megohms

# The duration of the voltage pulse must not exceed 15 per cent of one vertical scanning cycle. In a 525-line, 30-frame system, 15 per cent of one vertical scanning cycle is 2.5 milliseconds.

† Under no conditions should this maximum value be exceeded.

### MEDIUM-MU TRIODE— SHARP-CUTOFF PENTODE

## 6KZ8

Related type:  
9KZ8

Miniature type used as combined oscillator and mixer in vhf television receivers employing series-connected heater strings. Outline 6B, Outlines section. Tube requires miniature nine-contact socket and may be mounted

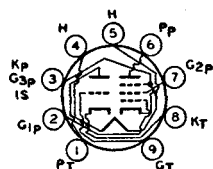

9FZ

in any position. Type 9KZ8 is identical with type 6KZ8 except for the heater ratings, as shown below.

	6KZ8	9KZ8	
Heater Voltage (ac/dc)	6.3	9.45	volts
Heater Current	0.45	0.3	ampere
Heater Warm-up Time (Average)	11	11	seconds
Peak Heater-Cathode Voltage:			
Heater negative with respect to cathode	200 max	200 max	volts
Heater positive with respect to cathode	200*max	200*max	volts
Direct Interelectrode Capacitances: **			
Triode Unit:			
Grid to Plate		1.6	pF
Grid to Triode Cathode, Pentode Cathode, Heater, Pentode Grid No.3, and Heater		3.2	pF
Plate to Triode Cathode, Pentode Cathode, Heater, Pentode Grid No.3, and Heater		1.8	pF
Pentode Unit:			
Grid No.1 to Plate		0.01 max	pF
Grid No.1 to Cathode, Heater, Grid No.2, Grid No.3, and Internal Shield		5.5	pF
Plate to Cathode, Heater, Grid No.2, Grid No.3, and Internal Shield		3.4	pF
Heater to Cathode (Each Unit)		3.2#	pF

\* The dc component must not exceed 100 volts.

\*\* With external shield connected to cathode.

# With external shield connected to ground.

**Class A<sub>1</sub> Amplifier**

**MAXIMUM RATINGS (Design-Maximum Values):**

	Triode Unit	Pentode Unit	
Plate Voltage	330 max	330 max	volts
Grid-No.2 (Screen-Grid) Supply Voltage	—	330 max	volts
Grid-No.2 Voltage	—	See curve page 80	
Grid-No.1 (Control-Grid) Voltage, Positive-bias value	0 max	0 max	volts
Plate Dissipation	2.5 max	2.5 max	watts
Grid-No.2 Input:			
For grid-No.2 voltages up to 165 volts	—	0.55 max	watt
For grid-No.2 voltages between 165 and 330 volts	—	See curve page 80	

**CHARACTERISTICS:**

Plate Voltage	125	125	volts
Grid-No.2 Voltage	—	125	volts
Grid-No.1 Voltage	-1	-1	volt
Amplification Factor	46	—	
Plate Resistance (Approx.)	5400	200000	ohms
Transconductance	8500	7500	μmhos
Plate Current	13.5	12	mA
Grid-No.2 Current	—	4	mA
Grid-No.1 Voltage (Approx.) for plate current of 10 μA	-8	-8	volts

**MAXIMUM CIRCUIT VALUES:**

Grid-No.1-Circuit Resistance:			
For fixed-bias operation	0.25 max	0.25 max	megohm
For cathode-bias operation	0.5 max	0.5 max	megohm

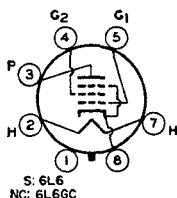

**7AC**

**BEAM POWER TUBE**

Metal type 6L6 and glass octal type 6L6GC are used in the output stage of audio amplifying equipment, especially units designed to have ample reserve of power-delivering ability. These types provide high power output, sensitivity, and high efficiency. Power output at all levels has low third- and higher-order harmonics. Type 6L6, Outline 4, type 6L6GC, Outline 19D; Outlines section. Tubes require an octal socket and may be mounted in any position. It is especially important that these tubes, like other power-handling tubes, be adequately ventilated. Type 6L6GC can be used in place of type 6L6 and may be supplied with pin 1 omitted.

**6L6**  
**6L6GC**

sensitivity, and high efficiency. Power output at all levels has low third- and higher-order harmonics. Type 6L6, Outline 4, type 6L6GC, Outline 19D; Outlines section. Tubes require an octal socket and may be mounted in any position. It is especially important that these tubes, like other power-handling tubes, be adequately ventilated. Type 6L6GC can be used in place of type 6L6 and may be supplied with pin 1 omitted.

Heater Voltage (ac/dc)		6.3	volts
Heater Current		0.9	ampere
Peak Heater-Cathode Voltage:			
Heater negative with respect to cathode	180 max	200 max	volts
Heater positive with respect to cathode	180 max	200 max	volts
Direct Interelectrode Capacitances (Approx.):	6L6*	6L6GC	
Grid No.1 to Plate	0.4	0.6	pF
Grid No.1 to Cathode, Heater, Grid No.2, and Grid No.3	10	10	pF
Plate to Cathode, Heater, Grid No.2, and Grid No.3	12	6.5	pF

\* With pin 1 connected to pin 8.

**Class A<sub>1</sub> Amplifier**

**MAXIMUM RATINGS:**

	6L6 Design-Center Values	6L6GC Design-Maximum Values	
Plate Voltage	360 max	500 max	volts
Grid-No.2 (Screen-Grid) Voltage	270 max	450*max	volts
Plate Dissipation	19 max	30 max	watts
Grid-No.2 Input	2.5 max	5 max	watts

**TYPICAL OPERATION:**

Plate Voltage	250	300	350	volts
Grid-No.2 Voltage	250	200	250	volts
Grid-No.1 (Control-Grid) Voltage	-14	-12.5	-18	volts
Peak AF Grid-No.1 Voltage	14	12.5	18	volts
Zero-Signal Plate Current	72	48	54	mA
Maximum-Signal Plate Current	79	55	66	mA
Zero-Signal Grid-No.2 Current	5	2.5	2.5	mA
Maximum-Signal Grid-No.2 Current	7.3	4.7	7	mA
Plate Resistance (Approx.)	22500	35000	33000	ohms
Transconductance	6000	5300	5200	$\mu$ mhos
Load Resistance	2500	4500	4200	ohms
Total Harmonic Distortion	10	11	15	per cent
Maximum-Signal Power Output	6.5	6.5	10.8	watts

\* In push-pull circuits where grid No.2 of each tube is connected to a tap on the plate winding of the output transformer, this maximum rating is 500 volts.

**Class A<sub>1</sub> Amplifier (Triode Connection)<sup>†</sup>**

	6L6 Design- Center Values	6L6GC Design- Maximum Values	
<b>MAXIMUM RATINGS:</b>			
Plate Voltage	275 max	450 max	volts
Plate Dissipation (Total)	19 max	30 max	watts

**TYPICAL OPERATION:**

Plate Voltage		250	volts
Grid-No.1 Voltage		-20	volts
Peak AF Grid-No.1 Voltage		20	volts
Zero-Signal Plate Current		40	mA
Maximum-Signal Plate Current		44	mA
Plate Resistance (Approx.)		1700	ohms
Amplification Factor		8	
Transconductance		4700	$\mu$ mhos
Load Resistance		5000	ohms
Total Harmonic Distortion		5	per cent
Maximum-Signal Power Output		1.4	watts

<sup>†</sup> Grid No.2 connected to plate.

**Push-Pull Class A<sub>1</sub> Amplifier****MAXIMUM RATINGS:**

(Same as for Class A<sub>1</sub> Amplifier)

**TYPICAL OPERATION (Values are for two tubes):**

Plate Voltage	250	270	volts
Grid-No.2 Voltage	250	270	volts
Grid-No.1 Voltage	-16	-17.5	volts
Peak AF Grid-No.1-to-Grid-No.1 Voltage	32	35	volts
Zero-Signal Plate Current	120	134	mA
Maximum-Signal Plate Current	140	155	mA
Zero-Signal Grid-No.2 Current	10	11	mA
Maximum-Signal Grid-No.2 Current	16	17	mA
Effective Load Resistance (Plate-to-plate)	5000	5000	ohms
Total Harmonic Distortion	2	2	per cent
Maximum-Signal Power Output	14.5	17.5	watts

**Push-Pull Class AB<sub>1</sub> Amplifier****MAXIMUM RATINGS:**

(Same as for Class A<sub>1</sub> Amplifier)

**TYPICAL OPERATION**

(Values are for two tubes):

	6L6	6L6GC	
Plate Voltage	360	450	volts
Grid-No.2 Voltage	270	400	volts
Grid-No.1 Voltage	-22.5	-37	volts
Peak AF Grid-No.1-to-Grid-No.1 Voltage	45	70	volts
Zero-Signal Plate Current	88	116	mA
Maximum-Signal Plate Current	132	210	mA
Zero-Signal Grid-No.2 Current	5	5.6	mA
Maximum-Signal Grid-No.2 Current	15	22	mA
Effective Load Resistance (Plate-to-plate)	6600	3800	5600

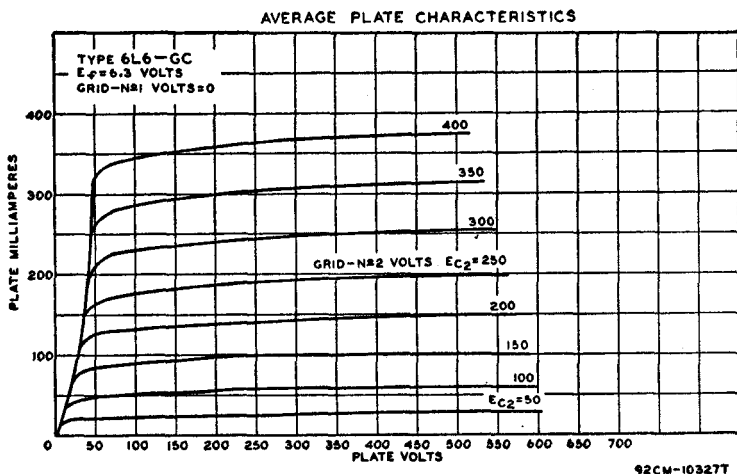

Total Harmonic Distortion .....	2	2	1.8	per cent
Maximum-Signal Power Output .....	26.5	18	55	watts

**Push-Pull Class AB<sub>2</sub> Amplifier**

**MAXIMUM RATINGS:**

(Same as for Class A<sub>1</sub> Amplifier)

**TYPICAL OPERATION (Values are for two tubes):**

Plate Voltage .....	360	360	volts
Grid-No.2 Voltage .....	225	270	volts
Grid-No.1 Voltage .....	-18	-22.5	volts
Peak AF Grid-No.1-to-Grid-No.1 Voltage .....	52	72	volts
Zero-Signal Plate Current .....	78	88	mA
Maximum-Signal Plate Current .....	142	205	mA
Zero-Signal Grid-No.2 Current .....	3.5	5	mA
Maximum-Signal Grid-No.2 Current .....	11	16	mA
Effective Load Resistance (Plate-to-plate) .....	6000	3800	ohms
Total Harmonic Distortion .....	2	2	per cent
Maximum-Signal Power Output .....	31	47	watts

**MAXIMUM CIRCUIT VALUES:**

**Grid-No.1-Circuit Resistance:**

For fixed-bias operation .....	0.1 max megohm
For cathode-bias operation .....	0.5 max megohm

**MEDIUM-MU TRIODE—  
SHARP-CUTOFF PENTODE**

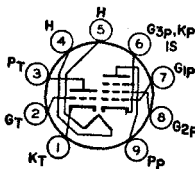

**9DX**

Neonovial type with frame-grid pentode used in television receivers. Triode unit is used as a voltage amplifier; the pentode unit is used as a video amplifier. Outline 10A, **Outlines** section. Tube requires neonovial nine-contact socket and may be mounted in any position.

**6L8**

Heater Voltage (ac/dc) .....	6.3	volts
Heater Current .....	0.725	ampere
Peak Heater-Cathode Voltage:		
Heater negative with respect to cathode .....	200 max	volts
Heater positive with respect to cathode .....	200* max	volts

## Direct Interelectrode Capacitances:

Triode Unit:		
Grid to Plate .....	2.8	pF
Grid to Triode Cathode, Pentode Cathode, Heater, Pentode Grid No.3, and Internal Shield .....	1.9	pF
Plate to Triode Cathode, Pentode Cathode, Heater, Pentode Grid No.3, and Internal Shield .....	1.8	pF
Pentode Unit:		
Grid No.1 to Plate .....	0.1 max	pF
Grid No.1 to Cathode, Heater, Grid No.2, Grid No.3, and Internal Shield .....	12	pF
Plate to Cathode, Heater, Grid No.2, Grid No.3, and Internal Shield .....	3	pF
Triode Grid to Pentode Plate .....	0.02 max	pF
Pentode Grid No.1 to Triode Plate .....	0.004 max	pF
Pentode Plate to Triode Plate .....	0.13 max	pF

• The dc component must not exceed 100 volts.

Class A<sub>1</sub> Amplifier

## MAXIMUM RATINGS (Design-Maximum Values):

	Triode Unit	Pentode Unit	
Plate Voltage .....	330 max	330 max	volts
Grid-No.2 (Screen-Grid) Supply Voltage .....	—	330 max	volts
Grid-No.2 Voltage .....	—	See curve page 80	
Grid-No.1 (Control-Grid) Voltage, Positive-bias value .....	0 max	0 max	volts
Plate Dissipation .....	2 max	4 max	watts
Grid-No.2 Input:			
For grid-No.2 voltages up to 165 volts .....	—	1.1 max	watts
For grid-No.2 voltages between 165 and 330 volts .....	—	See curve page 80	

## CHARACTERISTICS:

Plate Supply Voltage .....	125	50	200	volts
Grid-No.2 Supply Voltage .....	—	100	100	volts
Grid-No.1 Voltage .....	0	0	0	volts
Cathode-Bias Resistor .....	68	—	82	ohms
Amplification Factor .....	30	—	—	
Plate Resistance (Approx.) .....	6000	—	5000	ohms
Transconductance .....	5000	—	20000	μmhos
Plate Current .....	13	55*	17	mA
Grid-No.2 Current .....	—	18*	3.5	mA
Grid-No.1 Voltage (Approx.) for plate current of 20 μA .....	-10	—	—	volts
Grid-No.1 Voltage (Approx.) for plate current of 100 μA .....	—	—	-5	volts

## MAXIMUM CIRCUIT VALUES:

Grid-No.1 Circuit Resistance:			
For fixed-bias operation .....	0.5 max	0.25 max	megohm
For cathode-bias operation .....	1 max	1 max	megohm

\* This value can be measured by a method involving a recurrent waveform such that the maximum ratings of the tube will not be exceeded.

HIGH-MU TRIODE—  
SHARP-CUTOFF PENTODE**6LC8**

Related type:  
8LC8

Miniature type used in color and black-and-white television receivers. Pentode unit is used in noise-immune gated-agc-amplifier circuits, and the triode unit in sync-separator circuits. Outline 6E, Outlines section. Tube

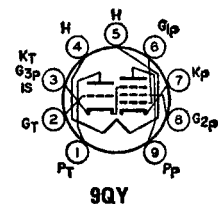

8QY

requires miniature nine-contact socket and may be mounted in any position. Type 8LC8 is identical with type 6LC8 except for heater ratings, as shown below. For curves of average plate characteristics, refer to type 6KA8.

Heater Voltage (ac/dc) .....	6LC8	8LC8	
Heater Current .....	6.3	8.4	volts
Heater Warm-up Time (Average) .....	0.6	0.45	ampere
	11	11	seconds

<b>Peak Heater-Cathode Voltage:</b>			
Heater negative with respect to cathode .....	200 max	200 max	volts
Heater positive with respect to cathode .....	200*max	200*max	volts
<b>Direct Interelectrode Capacitances:</b>			
<b>Triode Unit:</b>			
Grid to Plate .....		2.2	pF
Grid to Cathode, Heater, Pentode Grid No.3, and Internal Shield .....		2.8	pF
Plate to Cathode, Heater, Pentode Grid No.3, and Internal Shield .....		2.2	pF
<b>Pentode Unit:</b>			
Grid No.1 to Plate .....		0.10 max	pF
Grid No.1 to Cathode, Heater, Grid No.3, Triode Cathode, and Internal Shield .....		10	pF
Grid No.3, Triode Cathode, and Internal Shield to Plate .....		3.4	pF
Grid No.1 to Grid No.3, Triode Cathode, and Internal Shield .....		0.36	pF
Grid No.3, Triode Cathode, and Internal Shield to Plate, Cathode, Heater, Grid No.1, and Grid No.2 .....		12.5	pF

\* The dc component must not exceed 100 volts.

**Class A<sub>1</sub> Amplifier**

<b>MAXIMUM RATINGS (Design-Maximum Values):</b>			
Plate Voltage .....		Triode Unit 300 max	volts
<b>Grid Voltage:</b>			
Positive-bias value .....		0 max	volts
Negative-bias value .....		-50 max	volts
Plate Dissipation .....		1.1 max	watts
<b>CHARACTERISTICS:</b>			
	<b>Triode Unit</b>	<b>Pentode Unit</b>	
Plate Supply Voltage .....	200	150	volts
Grid-No.2 Supply Voltage .....	—	100	volts
Grid-No.1 Voltage .....	-2	—	volts
Cathode-Bias Resistor .....	—	180	ohms
Amplification Factor .....	70	—	
Plate Resistance (Approx.) .....	17500	* 100000	ohms
Transconductance, Grid No.1 to Plate .....	4000	4400	μmhos
Transconductance, Grid No.3 to Plate .....	—	600	μmhos
Plate Current .....	4	4	mA
Grid-No.2 Current .....	—	2.8	mA
<b>Grid-No.1 Voltage (Approx.):</b>			
For plate current of 10 μA .....	-5	—	volts
For plate current of 20 μA .....	—	-4	volts
Grid-No.3 Voltage (Approx.) for plate current of 20 μA .....	—	-7*	volts

<b>MAXIMUM CIRCUIT VALUES:</b>			
<b>Grid-Circuit Resistance:</b>			
For fixed-bias operation .....		Triode Unit 0.25 max	megohm
For cathode-bias operation .....		1 max	megohm

\* With no external connection to triode plate and triode grid.

**Gated AGC Amplifier and Noise Inverter**

For operation in a 525-line, 30-frame system

<b>MAXIMUM RATINGS (Design-Maximum Values):</b>			
DC Plate Voltage .....		Pentode Unit 300 max	volts
Peak Positive-Pulse Plate Voltage* .....		600 max	volts
<b>Grid-No.3 (Control-Grid) Voltage:</b>			
Positive-bias value .....		0 max	volts
Negative-bias value .....		-100 max	volts
Grid-No.2 (Screen-Grid) Supply Voltage .....		300 max	volts
Grid-No.2 Voltage .....		See curve page 80	
<b>Grid-No.1 (Control-Grid) Voltage:</b>			
Positive-bias value .....		0 max	volts
Negative-bias value .....		-50 max	volts
Plate Dissipation .....		2 max	watts
<b>Grid-No.2 Input:</b>			
For grid-No.2 voltages up to 150 volts .....		1.1 max	watts
For grid-No.2 voltages between 150 and 300 volts .....		See curve page 80	

**MAXIMUM CIRCUIT VALUES:**

Grid-No.1-Circuit Resistance:

For fixed-bias operation .....	0.5 max megohm
For cathode-bias operation .....	1 max megohm

• The duration of the voltage pulse must not exceed 15 per cent of one horizontal scanning cycle. In a 525-line, 30-frame system, 15 per cent of one horizontal scanning cycle is 10 microseconds.

**TWIN PENTODE****6LE8**

Miniature type used as combined color demodulator and matrix amplifier in color television receivers utilizing high-level demodulation systems. Outline 6G, **Outlines** section Tube requires miniature nine-contact socket

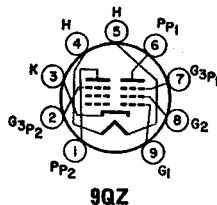

and may be mounted in any position.

Heater Voltage (ac/dc) .....	6.3	volts
Heater Current .....	0.76	ampere
Peak Heater-Cathode Voltage:		
Heater negative with respect to cathode .....	300 max	volts
Heater positive with respect to cathode .....	200*max	volts
Direct Interelectrode Capacitance (Approx.):		
Plate (Each Unit) to All Other Electrodes .....	3.7	pF
Grid No.1 to All Other Electrodes .....	15.5	pF
Grid No.3 (Each Unit) to All Other Electrodes .....	6	pF
Grid No.3 to Plate (Each Unit) .....	2.7	pF
Grid No.3 (Unit No.1) to Grid No.3 (Unit No.2) .....	0.1	pF

\* The dc component must not exceed 100 volts.

**Class A<sub>1</sub> Amplifier****MAXIMUM RATINGS** (Design-Maximum Values):

Plate Voltage (Each Unit) .....	300 max	volts
Grid-No.2 (Screen-Grid) Voltage .....	150 max	volts
Plate Dissipation (Each Unit) .....	2 max	watts
Grid-No.2 Input .....	2 max	watts

**CHARACTERISTICS** (Each Unit):

Plate Voltage .....	100	volts
Grid-No.3 (Suppressor-Grid) Voltage .....	0	volts
Grid-No.2 Voltage .....	100	volts
Grid-No.1 (Control-Grid) Voltage, Negative-bias value .....	-2.5	volts
Transconductance (Approx.):		
Grid-No.1 to Plate .....	5800	μmhos
Grid-No.3 to Plate .....	350	μmhos
Plate Resistance (Approx.) .....	50000	ohms
Plate Current .....	7.6	mA
Grid-No.2 Current .....	14.5	mA
Grid-No.1 Voltage for plate current of 20 μA .....	-7.2	volts
Grid-No.1 Voltage for plate current of 100 μA .....	-6.3	volts
Grid-No.3 Voltage for plate current of 20 μA .....	-17.5**	volts
Grid-No.3 Voltage for plate current of 100 μA .....	-16.5**	volts

\*\* For this test, a grid-No.1 voltage of -3 volts is used to keep the grid-No.2 input within tube ratings.

**HIGH-MU TRIODE—  
SHARP-CUTOFF PENTODE****6LF8**

Miniature type used in video-amplifier stages of color-television receivers and in other applications where operation of a triode in the positive-grid region is desirable. Outline 6E, **Outlines** section. Tube requires miniature nine-contact socket and may be mounted in any position.

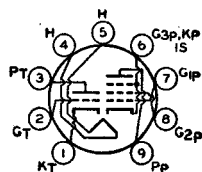
**9DX**



Heater Voltage (ac/dc) .....	6.3	volts
Heater Current .....	0.6	ampere
Heater Warm-up Time (Average) .....	11	seconds
<b>Peak Heater-Cathode Voltage:</b>		
Heater negative with respect to cathode .....	200 max	volts
Heater positive with respect to cathode .....	200*max	volts
<b>Direct Interelectrode Capacitances:</b>		
<b>Triode Unit:</b>		
Grid to Plate .....	2.2	pF
Grid to Cathode, Heater, Pentode Cathode, Pentode Grid No.3, and Internal Shield .....	3.2	pF
Plate to Cathode, Heater, Pentode Cathode, Pentode Grid. No.3, and Internal Shield .....	1.8	pF
<b>Pentode Unit:</b>		
Grid No.1 to Plate .....	0.06 max	pF
Grid No.1 to Cathode, Heater, Grid No.2, Grid No.3, and Internal Shield .....	10	pF
Plate to Cathode, Heater, Grid No.2, Grid No.3, and Internal Shield .....	3.6	pF
Pentode Grid No.1 to Triode Plate .....	0.008 max	pF
Pentode Plate to Triode Plate .....	0.15 max	pF

\*The dc component must not exceed 100 volts.

**Class A Amplifier**

**MAXIMUM RATINGS (Design-Maximum Values):**

	Triode Unit	Pentode Unit	
Plate Voltage .....	330 max	330 max	volts
Grid-No.2 (Screen-Grid) Supply Voltage .....	—	330 max	volts
Grid-No.2 Voltage .....	—	See curve page 80	
<b>Grid-No.1 (Control-Grid) Voltage:</b>			
Positive-bias value .....	4 max	0 max	volts
Negative-bias value .....	-55 max	-55 max	volts
Plate Dissipation .....	1.1 max	3.75 max	watts
<b>Grid-No.2 Input:</b>			
For grid-No.2 voltages up to 165 volts .....	—	1.1 max	watts
For grid-No.2 voltages between 165 and 330 volts ..	—	See curve page 80	
Grid-No.1 Current .....	8 max	0 max	mA

**CHARACTERISTICS:**

	200	40	75	100	volts
Plate Voltage .....	—	—	150	150	volts
Grid-No.2 Voltage .....	—	3	0	-2.5	volts

**AVERAGE CHARACTERISTICS**  
TRIODE UNIT

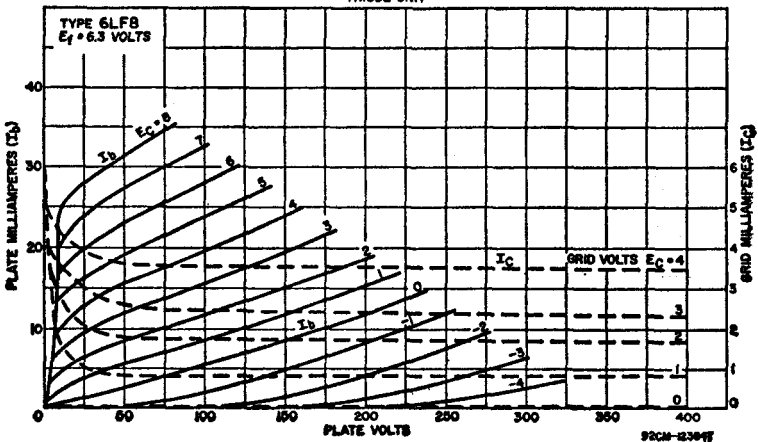

Amplification Factor .....	70	40	—	—	
Plate Resistance (Approx.) .....	17500	10000	—	200000	ohms
Transconductance .....	4000	4000	—	11000	$\mu$ mhos
Plate Current .....	4	11	50*	20	mA
Grid-No.2 Current .....	—	—	12*	5	mA
Grid-No.1 Current .....	0	2.7	0	0	mA
Grid-No.1 Voltage (Approx.) for plate current of 20 $\mu$ A .....	-5	—	—	-8	volts

**MAXIMUM CIRCUIT VALUES:****Grid-No.1-Circuit Resistance:**

For fixed-bias operation .....	0.5 max	0.25 max megohm
For cathode-bias operation .....	1 max	1 max megohm

\* This value can be measured by a method involving a recurrent waveform such that the maximum ratings of the tube will not be exceeded.

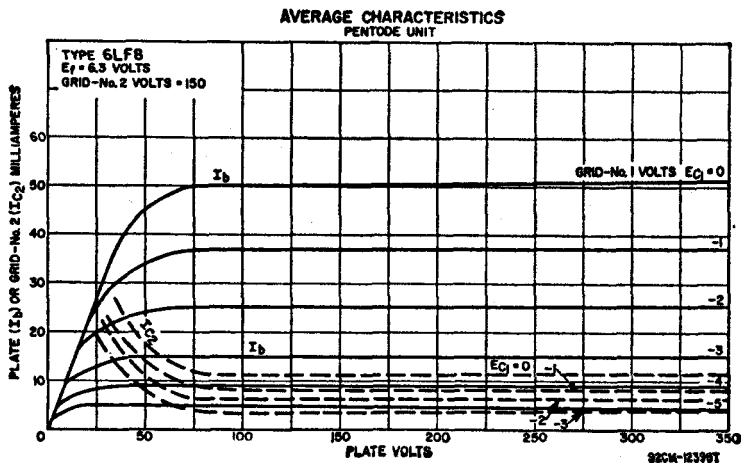

### MEDIUM-MU TRIODE— SEMIREMOTE-CUTOFF PENTODE

**6LM8**

Miniature type used in a wide variety of circuit applications in color and black-and-white television receivers. The pentode unit is used in burst-amplifier circuits, and the triode unit as a general-purpose amplifier tube.

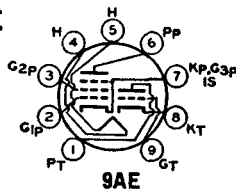

Outline 6B, **Outlines** section. Tube requires miniature nine-contact socket and may be mounted in any position.

Heater Voltage (ac/dc) .....	6.3	volts
Heater Current .....	0.45	ampere
Peak Heater-Cathode Voltage:		
Heater negative with respect to cathode .....	200 max	volts
Heater positive with respect to cathode .....	200* max	volts
Direct Interelectrode Capacitances:		
Triode Unit:		
Grid to Plate .....	1.8	pF
Grid to Cathode, Heater, Pentode Cathode, Pentode Grid No.3, and Internal Shield .....	3.2	pF
Plate to Cathode, Heater, Pentode Cathode, Pentode Grid No.3, and Internal Shield .....	1.9	pF

Pentode Unit:

Grid No.1 to Plate .....	0.015 max	pF
Grid No.1 to Cathode, Heater, Grid No.2, Grid No. 3, and Internal Shield .....	5.5	pF
Plate to Cathode, Heater, Grid No.2, Grid No.3, and Internal Shield .....	3.8	pF
Heater to Cathode (Each Unit) .....	3.2	pF

• The dc component must not exceed 100 volts.

Class A<sub>1</sub> Amplifier

MAXIMUM RATINGS (Design-Maximum Values):

	Triode Unit	Pentode Unit	
Plate Voltage .....	330 max	350 max	volts
Grid-No.2 (Screen-Grid) Supply Voltage .....	—	330 max	volts
Grid-No.2 Voltage .....	—	See curve page 80	
Grid-No.1 (Control-Grid) Voltage, Positive-bias value .....	0 max	0 max	volts
Plate Dissipation .....	2.5 max	2.5 max	volts
Grid-No.2 Input:			
For grid-No.2 voltages up to 165 volts .....	—	0.55 max	watts
For grid-No.2 voltages between 165 and 330 volts .....	—	See curve page 80	

AVERAGE CHARACTERISTICS  
PENTODE UNIT

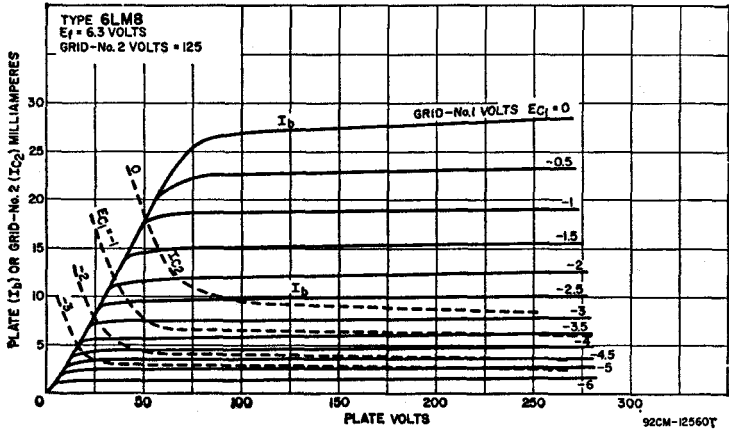

AVERAGE PLATE CHARACTERISTICS  
TRIODE UNIT

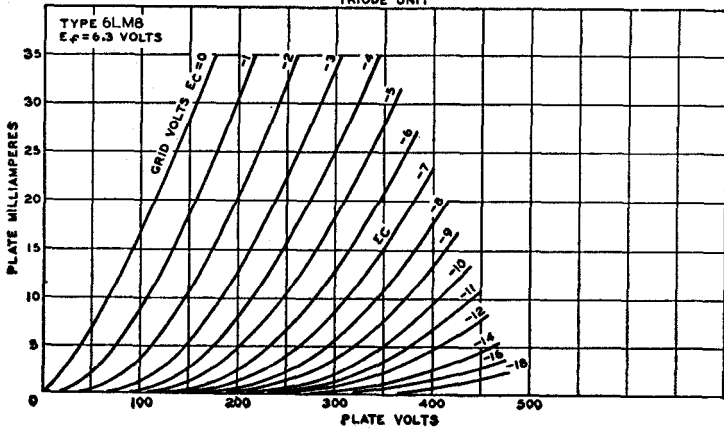

**CHARACTERISTICS:**

Plate Voltage	125	125	volts
Grid-No.2 Voltage	—	125	volts
Grid-No.1 Voltage	—1	—2	volts
Amplification Factor	46	—	
Plate Resistance (Approx.)	5400	15000	ohms
Transconductance	8500	6000	μmhos
Plate Current	13.5	12	mA
Grid-No.2 Current	—	4	mA
Grid-No.1 Voltage (Approx.) for plate current of 10 mA	—8	—14	volts

**MAXIMUM CIRCUIT VALUES:**

Grid-No.1-Circuit Resistance:			
For fixed-bias operation	0.5 max	0.25 max	megohm
For cathode-bias operation	1 max	0.5 max	megohm

**MEDIUM-MU TRIODE—  
SHARP-CUTOFF PENTODE****6LN8**

Miniature type used in frequency-changer service in television receivers employing series-connected heater strings. Outline 6B, **Outlines** section. Tube requires miniature nine-contact socket and may be mounted in any position.

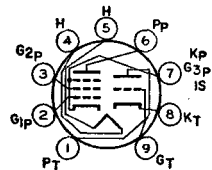
**9DC**

Heater Voltage (ac/dc)	6.0	volts
Heater Current	0.45	ampere
Peak Heater-Cathode Voltage:		
Heater negative with respect to cathode	100 max	volts
Heater positive with respect to cathode	100 max	volts

**Class A<sub>1</sub> Amplifier****MAXIMUM RATINGS (Design-Center Values):**

	Triode Unit	Pentode Unit	
Plate Supply Voltage	550 max	550 max	volts
Plate Voltage	250 max	250 max	volts
Grid-No.2 (Screen-Grid) Supply Voltage	—	550 max	volts
Grid-No.2 Voltage:			
With cathode current of 14 mA	—	175 max	volts
With cathode current less than 10 mA	14 max	14 max	mA
Cathode Current	—	200 max	volts
Grid-No.2 Input:	—	0.5 max	watt
With plate dissipation greater than 1.2 watts	—	—	—
With plate dissipation less than 1.2 watts	—	0.75 max	watt
Plate Dissipation	1.5 max	1.7 max	watts

**CHARACTERISTICS:**

Plate Voltage	100	170	volts
Grid-No.2 Voltage	—	170	volts
Grid-No.1 Voltage	—2	—2	volts
Amplification Factor	20	—	
Mu-Factor, Grid No.2 to Grid No.1	—	47	
Plate Resistance (Approx.)	—	0.4	megohm
Transconductance	5000	6200	μmhos
Plate Current	14	10	mA
Grid-No.2 Current	—	2.8	mA
Input Resistance at frequency of 50 Mc/s	—	0.01	megohm
Equivalent Noise Resistance	—	1500	ohms

**MAXIMUM CIRCUIT VALUES:**

Grid-No.1-Circuit Resistance:			
For fixed-bias operation	0.5 max	0.5 max	megohm
For cathode-bias operation	0.5 max	1 max	megohm

**HIGH-MU TWIN TRIODE—  
SHARP-CUTOFF PENTODE**

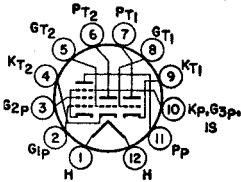

**12CA**

Duodecar type used in television receivers. The triode units are used in sync-separator and agc-amplifier circuits; the pentode unit is used in if-amplifier circuits. Outline 8B, **Outlines** section. Tube requires duodecar

twelve-contact socket and may be mounted in any position.

**6M11**

Heater Voltage (ac/dc)	6.3	volts
Heater Current	0.77	ampere
<b>Peak-Heater-Cathode Voltage:</b>		
Heater negative with respect to cathode	200 max	volts
Heater positive with respect to cathode	200*max	volts
<b>Direct Interelectrode Capacitances:**</b>		
<b>Triode Units:</b>		
Grid to Plate	1.8	pF
Grid to Triode Cathode, Pentode Cathode, Heater, Pentode Grid No.3, and Internal Shield	3.4	pF
Plate to Triode Cathode, Pentode Cathode, Heater, Pentode Grid No.3, and Internal Shield	0.8	pF
<b>Pentode:</b>		
Grid No.1 to Plate	0.03	pF
Grid No.1 to Cathode, Grid No.2, Grid No.3, and Internal Shield	12	pF
Plate to Cathode, Grid No.2, Grid No.3, and Internal Shield	2.8	pF

\* The dc component must not exceed 100 volts.

\*\* With external shield connected to pentode cathode, grid No.3, and internal shield.

**Class A<sub>1</sub> Amplifier**

**MAXIMUM RATINGS (Design-Maximum Values):**

	Each Triode Unit	Pentode Unit	
Plate Voltage	330 max	330 max	volts
Grid-No.2 (Screen-Grid) Supply Voltage	—	330 max	volts
Grid-No.2 Voltage	—	See curve page 80	
Grid-No.1 (Control-Grid) Voltage, Positive-bias value	0 max	0 max	volts
Plate Dissipation	2.25 max	3.1 max	watts
Grid-No.2 Input:			
For voltages up to 165 volts	—	0.65 max	watts
For voltages between 165 and 330 volts	—	See curve page 80	

**CHARACTERISTICS:**

Plate Supply Voltage	125	125	volts
Grid-No.2 Supply Voltage	—	125	volts
Cathode-Bias Resistor	125	56	ohms
Amplification Factor	58	—	
Plate Resistance (Approx.)	7250	200000	ohms
Transconductance	8000	13000	μmhos
Plate Current	8	11	mA
Grid-No.2 Current	—	3.4	mA
Grid-No.1 Voltage (Approx.) for plate current of 20 μA	—	—3.5	volts
Grid-No.1 Voltage (Approx.) for plate current of 50 μA	—4.5	—	volts

**MAXIMUM CIRCUIT VALUES:**

Grid-No.1-Circuit Resistance:			
For cathode-bias operation	0.68 max	1 max	megohm

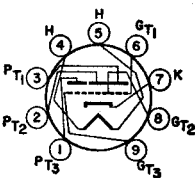

**9RQ**

**MEDIUM-MU TRIPLE TRIODE**

Novar type used in matrixing circuits of color television receivers. Outline 11E, **Outlines** section. Tube requires novar nine-contact socket and may be mounted in any position.

**6MD8**

Heater Voltage (ac/dc) .....	6.3	volts		
Heater Current .....	0.9	ampere		
Peak Heater-Cathode Voltage:				
Heater negative with respect to cathode .....	200 max	volts		
Heater positive with respect to cathode .....	200*max	volts		
Direct Interelectrode Capacitances (Approx.):	No.1	No.2	No.3	
	Unit	Unit	Unit	
Grid to Plate .....	3	3	3	pF
Grid to Cathode and Heater .....	3.6	3.6	3.4	pF
Plate to Cathode and Heater .....	0.48	0.48	0.36	pF

**Class A<sub>1</sub> Amplifier (Each Unit)**

**MAXIMUM RATINGS (Design-Maximum Values):**

Plate Voltage .....	330 max	volts
Grid Voltage, Positive-bias value .....	0 max	volts
Plate Dissipation .....	3 max	watts

**CHARACTERISTICS:**

Plate Voltage .....	250	volts
Grid Voltage .....	-10.5	volts
Amplification Factor .....	17	
Plate Resistance (Approx.) .....	5500	ohms
Transconductance .....	3100	$\mu$ mhos
Plate Current .....	11.5	mA
Plate Current for grid voltage of -14 volts .....	4	mA
Grid Voltage (Approx.) for plate current of 50 $\mu$ A .....	-23	volts

**MAXIMUM CIRCUIT VALUES:**

Grid-Circuit Resistance:	
For fixed-bias operation .....	1 max megohm

\* The dc component must not exceed 100 volts.

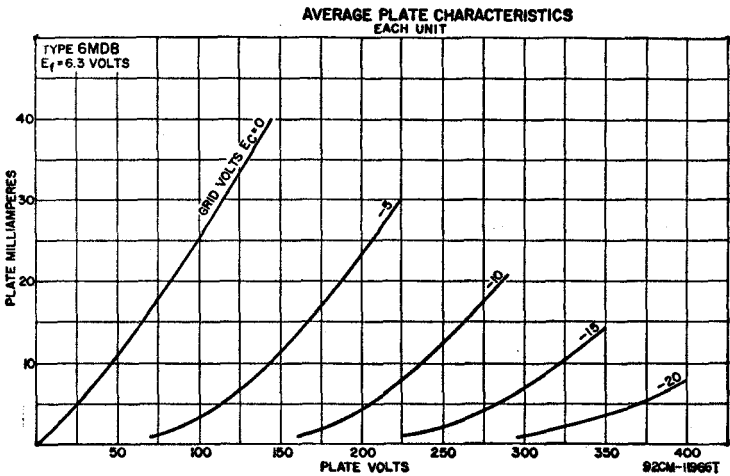

**MEDIUM-MU TRIODE**

Miniature type having high permeance used as vertical deflection amplifier in television receivers. This type has a controlled heater warm-up time for use in television receivers employing series-connected heater strings. Out-



**6S4A**

line 6E, **Outlines** section. Tube requires miniature nine-contact socket and may be mounted in any position.

Heater Voltage (ac/dc) .....	6.3	volts
Heater Current .....	0.6	ampere
Heater Warm-up Time (Average) .....	11	seconds
<b>Peak Heater-Cathode Voltage:</b>		
Heater negative with respect to cathode .....	200 max	volts
Heater positive with respect to cathode .....	200*max	volts
<b>Direct Interelectrode Capacitances (Approx.):</b>		
Grid to Plate .....	2.4	pF
Grid to Cathode and Heater .....	4.2	pF
Plate to Cathode and Heater .....	0.6	pF

• The dc component must not exceed 100 volts.

### Class A<sub>1</sub> Amplifier

**CHARACTERISTICS:**

Plate Voltage .....	250	volts
Grid Voltage .....	-8	volts
Amplification Factor .....	16.5	
Plate Resistance (Approx.) .....	3700	ohms
Transconductance .....	4500	μmhos
Plate Current .....	24	mA
Plate Current for grid voltage of -15 volts .....	4	mA
Grid Voltage (Approx.) for plate current of 50 μA .....	-22	volts

### Vertical Deflection Amplifier

For operation in a 525-line, 30-frame system

**MAXIMUM RATINGS (Design-Maximum Values):**

DC Plate Voltage .....	550 max	volts
Peak Positive-Pulse Plate Voltage† .....	2200 max	volts
Peak Negative-Pulse Grid Voltage .....	-250 max	volts
Peak Cathode Current .....	105 max	mA
Average Cathode Current .....	30 max	mA
Plate Dissipation .....	8.5 max	watts

**MAXIMUM CIRCUIT VALUE:**

Grid-Circuit Resistance: For cathode-bias operation .....	2.2 max megohms
--	-----------------

† The duration of the voltage pulse must not exceed 15 per cent of one vertical scanning cycle. In a 525-line, 30-frame system, 15 per cent of one vertical scanning cycle is 2.5 milliseconds.

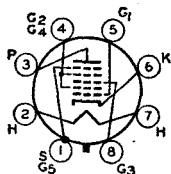

8R

### PENTAGRID CONVERTER

Metal type used as converter in super-heterodyne circuits. It is similar in performance to type 6BE6. For general discussion of pentagrid types, see **Frequency Conversion in Electron Tube Applications** section. This tube

## 6SA7

Related type:  
12SA7

has excellent frequency stability. Tube requires octal socket and may be mounted in any position. Outline 2A, **Outlines** section. Type 12SA7 is identical with type 6SA7 except for the heater ratings, as shown below.

	6SA7	12SA7	
Heater Voltage (ac/dc) .....	6.3	12.6	volts
Heater Current .....	0.3	0.15	ampere
<b>Peak Heater-Cathode Voltage:</b>			
Heater negative with respect to cathode .....	90 max	90 max	volts
Heater positive with respect to cathode .....	90 max	90 max	volts
<b>Direct Interelectrode Capacitances:</b>			
Grid No.3 to All Other Electrodes (RF Input) .....		9.5*	pF
Plate to All Other Electrodes (Mixer Output) .....		9.5*	pF
Grid No.1 to All Other Electrodes (Osc. Input) .....		7*	pF
Grid No.3 to Plate .....		0.25 max*	pF
Grid No.3 to Grid No.1 .....		0.15 max*	pF

Grid No.1 to Plate .....	0.06 max*	pF
Grid No.1 to Shell, Grid No.5, and All Other Electrodes except Cathode .....	4.4	pF
Grid No.1 to Cathode .....	2.6	pF
Cathode to Shell, Grid No.5, and All Other Electrodes except Grid No.1 .....	5	pF

\* With shell connected to cathode.

### Converter

#### MAXIMUM RATINGS (Design-Center Values):

Plate Voltage .....	300 max	volts
Grids-No.2-and-No.4 (Screen-Grid) Voltage .....	100 max	volts
Grids-No.2-and-No.4 Supply Voltage .....	300 max	volts
Grid-No.3 (Control-Grid) Voltage:		
Negative bias value .....	-50 max	volts
Positive bias value .....	0 max	volts
Plate Dissipation .....	1.0 max	watt
Grids-No.2-and-No.4 Input .....	1.0 max	watt
Cathode Current .....	14 max	mA

#### TYPICAL OPERATION:

#### Separate Excitation†

Plate Voltage .....	100	250	volts
Grid No.5 and shell .....	Connected to cathode at socket		
Grids-No.2-and-No.4 Voltage .....	100	100	volts
Grid-No.3 Voltage .....	-2	-2	volts
Grid-No.1 (Oscillator-Grid) Resistor .....	20000	20000	ohms
Plate Resistance (Approx.) .....	0.5	1.0	megohm
Conversion Transconductance .....	425	450	$\mu$ mhos
Grid-No.3 Voltage (Approx.) for transconductance of 10 $\mu$ mhos .....	-25	-25	volts
Grid-No.3 Voltage (Approx.) for conversion transconductance of 100 $\mu$ mhos .....	-9	-9	volts
Plate Current .....	3.3	3.5	mA
Grids-No.2-and-No.4 Current .....	8.5	8.5	mA
Grid-No.1 Current .....	0.5	0.5	mA
Cathode Current .....	12.3	12.5	mA

NOTE: The transconductance between grid No.1 and grids No.2 and No.4 connected to plate (not oscillating) is 4500  $\mu$ mhos under the following conditions: grids No.1, No.3 at 0 volts; grids No.2 and No.4 and plate at 100 volts; grid No.5 and shell are connected to cathode at socket.

† The characteristics shown with separate excitation correspond very closely to those obtained in a self-excited oscillator circuit operating with zero bias.

## SHARP-CUTOFF PENTODE

Metal type used as rf amplifier and biased detector. As a detector, this type is capable of delivering large audio-frequency output voltage with relatively small input voltage. Outline 2A, Outlines section. Tube requires

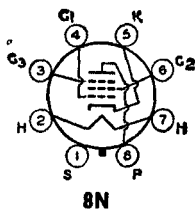

# 6SJ7

Related type:  
12SJ7

octal socket and may be mounted in any position. Type 12SJ7 is identical with type 6SJ7 except for the heater ratings, as shown below.

	6SJ7	12SJ7	
Heater Voltage (ac/dc) .....	6.3	12.6	volts
Heater Current .....	0.3	0.15	ampere
Peak Heater-Cathode Voltage:			
Heater negative with respect to cathode .....	90 max	90 max	volts
Heater positive with respect to cathode .....	90 max	90 max	volts
Direct Interelectrode Capacitances:*			
Pentode Connection:			
Grid No.1 to Plate .....		0.005 max	pF
Grid No.1 to Cathode, Heater, Grid No.2, and Grid No.3 .....		6.0	pF
Plate to Cathode, Heater, Grid No.2, and Grid No.3 .....		7.0	pF



Triode Connection:*		
Grid No.1 to Plate .....	2.8	pF
Grid No.1 to Cathode and Heater .....	3.4	pF
Plate to Cathode and Heater .....	11	pF

- \* With shell connected to cathode.
- With grids No.2 and No.3 connected to plate.

**Class A<sub>1</sub> Amplifier**

**MAXIMUM RATINGS (Design-Center Values):**

	Triode Connection*	Pentode Connection	
Plate Voltage .....	250 max	300 max	volts
Grid-No.2 (Screen-Grid) Voltage .....	—	See curve page 80	
Grid-No.2 Supply Voltage .....	—	300 max	volts
Grid-No.1 (Control-Grid) Voltage, Positive-bias value .....	0 max	0 max	volts
Plate Dissipation .....	2.5 max	2.5 max	watts
Grid-No.2 Input:			
For grid-No.2 voltages up to 150 volts .....	—	0.7 max	watt
For grid-No.2 voltages between 150 and 300 volts .....	—	See curve page 80	

**TYPICAL OPERATION:**

	Triode Connection*		Pentode Connection		
Plate Voltage .....	180	250	100	250	volts
Grid No.3 .....	—	—	Connected to cathode at socket		
Grid-No.2 Voltage .....	—	—	100	100	volts
Grid-No.1 Voltage .....	-6	-8.5	-3	-3	volts
Amplification Factor .....	19	19	—	—	
Plate Resistance (Approx.) .....	8250	7600	700000	†	ohms
Transconductance .....	2300	2500	1575	1650	μmhos
Grid-No.1 Voltage (Approx.) for plate current of 10 μA .....	—	—	-8	-8	volts
Plate Current .....	6.0	9.2	2.9	3.0	volts
Grid-No.2 Current .....	—	—	0.9	0.8	mA

\* Grids No.2 and No.3 connected to plate.

† Greater than 1 megohm.

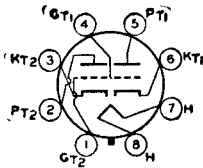

**HIGH-MU TWIN TRIODE**

Glass octal type used as phase inverter in radio equipment. Each unit amplifier circuits. Outline 13D, Out-socket and may be mounted in any lines section. Tube requires octal may also be used in resistance-coupled

**6SL7GT**

Related type:  
12SL7GT

position. Except for the common heater, each triode unit is independent of the other. For typical operation as phase inverter or resistance-coupled amplifier, refer to **Resistance-Coupled Amplifier** section. Type 12SL7GT is identical with type 6SL7GT except for the heater ratings, as shown below.

	6SL7GT	12SL7GT	
Heater Voltage (ac/dc) .....	6.3	12.6	volts
Heater Current .....	0.3	0.15	ampere
Peak Heater-Cathode Voltage:			
Heater negative with respect to cathode .....	90 max	90 max	volts
Heater positive with respect to cathode .....	90 max	90 max	volts
Direct Interelectrode Capacitances (Approx.):*	Unit No.1	Unit No.2	
Grid to Plate .....	2.8	2.8	pF
Grid to Cathode and Heater .....	3.0	3.4	pF
Plate to Cathode and Heater .....	3.8	3.2	pF

\* With external shield connected to cathode.

**Class A<sub>1</sub> Amplifier**

**MAXIMUM RATINGS (Design-Center Values):**

Plate Voltage .....	300 max	volts
Grid Voltage, Positive-bias value .....	0 max	volts
Plate Dissipation .....	1 max	watt

**CHARACTERISTICS:**

Plate Voltage .....	250	volts
Grid Voltage .....	-2	volts
Amplification Factor .....	70	
Plate Resistance (Approx.) .....	44000	ohms
Transconductance .....	1600	$\mu$ mhos
Plate Current .....	2.3	mA

**MEDIUM-MU TWIN TRIODE****6SN7GTB**

Related types:  
12SN7GTA

Glass octal type used as combined vertical oscillator and vertical deflection amplifier, and as horizontal deflection oscillator, in television receivers. Each unit may also be used in multivibrator or resistance-coupled

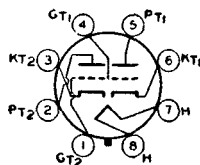
**8BD**

amplifier circuits in radio equipment. This type has a controlled heater warm-up time to permit use in series-connected heater strings. Outline 13D, **Outlines** section. Tube requires octal socket and may be mounted in any position. Except for the common heater, each triode unit is independent of the other. For typical operation as resistance-coupled amplifier, refer to **Resistance-Coupled Amplifier** section. Type 12SN7GTA is identical with type 6SN7GTB except for the heater ratings, as shown below.

	6SN7GTB	12SN7GTA	
Heater Voltage (ac/dc) .....	6.3	12.6	volts
Heater Current .....	0.6	0.3	ampere
Heater Warm-up Time (Average) .....	11	—	seconds
Peak Heater-Cathode Voltage:			
Heater negative with respect to cathode .....	200 max	200 max	volts
Heater positive with respect to cathode .....	200*max	200*max	volts
Direct Interelectrode Capacitances (Approx.):	Unit No1	Unit No2	
Grid to Plate .....	4.0	3.8	pF
Grid to Cathode and Heater .....	2.2	2.6	pF
Plate to Cathode and Heater .....	0.7	0.7	pF

\* The dc component must not exceed 100 volts.

**Class A<sub>1</sub> Amplifier (Each Unit)****MAXIMUM RATINGS (Design-Center Values):**

Plate Voltage .....	450 max	volts
Cathode Current .....	20 max	mA
Plate Dissipation:		
For either plate .....	5 max	watts
For both plates with both units operating .....	7.5 max	watts

**CHARACTERISTICS:**

Plate Voltage .....	90	250	volts
Grid Voltage .....	0	-8	volts
Amplification Factor .....	20	20	
Plate Resistance (Approx.) .....	6700	7700	ohms
Transconductance .....	3000	2600	$\mu$ mhos
Plate Current .....	10	9	mA
Plate Current for grid voltage of -12.5 volts .....	—	1.3	mA
Grid Voltage (Approx.) for plate current of 10 $\mu$ A ..	-7	-18	volts

**MAXIMUM CIRCUIT VALUE:**

Grid-Circuit Resistance:		
For fixed-bias operation .....	1.0 max	megohm

**Oscillator (Each Unit)**

For operation in a 525-line, 30-frame system

	Vertical Deflection Oscillator	Horizontal Deflection Oscillator	
<b>MAXIMUM RATINGS (Design-Center Values):</b>			
DC Plate Voltage .....	450 max	450 max	volts
Peak Negative-Pulse Grid Voltage .....	-400 max	-600 max	volts
Peak Cathode Current .....	70 max	300 max	mA
Average Cathode Current .....	20 max	20 max	mA

Plate Dissipation:			
For either plate .....	5 max	5 max	watts
For both plates with both units operating .....	7.5 max	7.5 max	watts
<b>MAXIMUM CIRCUIT VALUE:</b>			
Grid-Circuit Resistance .....	2.2 max	2.2 max	megohm

**Vertical Deflection Amplifier (Each Unit)**

For operation in a 525-line, 30-frame system

**MAXIMUM RATINGS (Design-Center Values):**

DC Plate Voltage .....	450 max	volts
Peak Positive-Pulse Plate Voltage* (Absolute maximum) .....	1500 max	volts
Peak Negative-Pulse Grid Voltage .....	-250 max	volts
Peak Cathode Current .....	70 max	mA
Average Cathode Current .....	20 max	mA
Plate Dissipation:		
For either plate .....	5 max	watts
For both plates with both units operating .....	7.5 max	watts

\* The duration of the voltage pulse must not exceed 15 per cent of one vertical scanning cycle. In a 525-line, 30-frame system, 15 per cent of one vertical scanning cycle is 2.5 milliseconds.  
 \* Under no circumstances should this absolute value be exceeded.

**MAXIMUM CIRCUIT VALUE:**

Grid-Circuit Resistance:		
For cathode-bias operation .....	2.2 max	megohms

**AVERAGE PLATE CHARACTERISTICS  
EACH TRIODE UNIT**

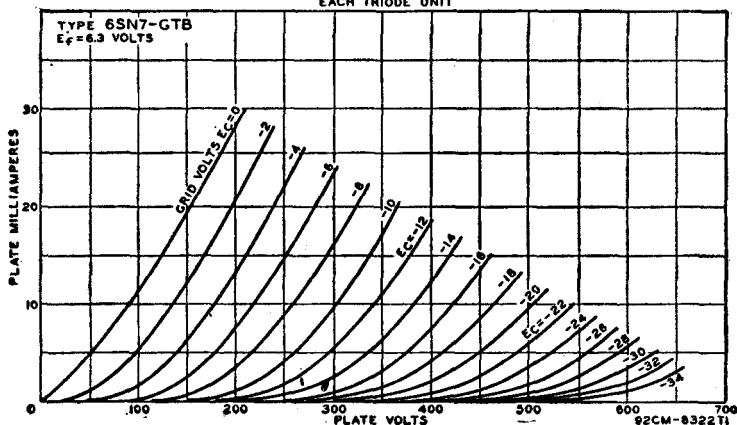

**TWIN DIODE—  
HIGH-MU TRIODE**

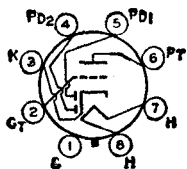

Metal type used as combined detector, amplifier, and avc tube in radio receivers. Outline 2A, Outlines section. Tube requires octal socket and may be mounted in any position. Diode-biasing of the triode unit is not suit-

**6SQ7**

Related type:  
12SQ7

able because of the probability of triode plate-current cutoff even with relatively small signal voltages applied to the diode circuit. Type 12SQ7 is identical with type 6SQ7 except for the heater ratings, as shown below.

Heater Voltage (ac/dc) .....	6SQ7	12SQ7	
Heater Current .....	6.3	12.6	volts
Peak Heater-Cathode Voltage:	0.3	0.15	ampere
Heater negative with respect to cathode .....	90 max	90 max	volts
Heater positive with respect to cathode .....	90 max	90 max	volts

Direct Interelectrode Capacitances:°

Triode Unit:

Grid to Plate .....	1.6	pF
Grid to Cathode and Heater .....	3.2	pF
Plate to Cathode and Heater .....	3	pF
Either Diode Plate to Cathode and Heater .....	3.3 max	pF
Triode Grid to Plate of Diode No.1 .....	0.03 max	pF
Triode Grid to Plate of Diode No.2 .....	0.04 max	pF

\*With shell connected to cathode.

Triode Unit as Class A<sub>1</sub> Amplifier

MAXIMUM RATINGS (Design-Center Values):

Plate Voltage .....	300 max	volts
Grid Voltage, Positive-bias value .....	0 max	volts
Plate Dissipation .....	0.5 max	watt

CHARACTERISTICS:

Plate Voltage .....	100	250	volts
Grid Voltage .....	-1	-2	volts
Amplification Factor .....	100	100	
Plate Resistance (Approx.) .....	110000	85000	ohms
Transconductance .....	925	1175	μmhos
Plate Current .....	0.5	1.1	mA

Diode Units

MAXIMUM RATING (Design-Center Value):

Plate Current (Each Unit) .....	1.0 max	mA
---------------------------------	---------	----

Two diode plates are placed around a cathode, the sleeve of which is common to the triode unit. Each diode plate has its own base pin. For diode operation curves, refer to type 6AV6.

TRIPLE DIODE—  
HIGH-MU TRIODE

**6T8A**

Related type:  
5T8

Miniature type used as combined audio amplifier, AM detector, and FM detector in AM/FM radio receivers. Diode unit No.1 is used for AM detection, and diode units No.2 and No.3 are used for FM detection. This type

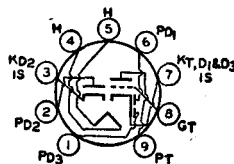

9E

has a controlled heater warm-up time for use in receivers employing series-connected heater strings. Outline 6B, **Outlines** section. Tube requires miniature nine-contact socket and may be mounted in any position. For typical operation as resistance-coupled amplifier, refer to **Resistance-Coupled Amplifier** section. Type 5T8 is identical with type 6T8A except for the heater ratings, as shown below.

Heater Voltage (ac/dc) .....	5T8 4.7	6T8A 6.3	volts
Heater Current .....	0.6	0.45	ampere
Heater Warm-up Time (Average) .....	11	11	seconds
Peak Heater-Cathode Voltage:			
Heater negative with respect to cathode .....	200 max	100 max	volts
Heater positive with respect to cathode .....	200 max#	100 max	volts

Direct Interelectrode Capacitances:

Triode Unit:

Grid to Plate .....	1.7	1.7	pF
Grid to Cathode, Internal Shield (pin 7), and Heater Plate to Cathode, Internal Shield (pin 7), and Heater .....	1.6	1.7	pF
Diode Units:			
Diode-No.1 Plate to Cathode, Internal Shield (pin 7), and Heater .....	3.8	3.8	pF
Diode-No.2 Plate to Cathode, Internal Shield (pin 3), and Heater .....	3.8	3.8*	pF
Diode-No.3 Plate to Cathode, Internal Shield (pin 7), and Heater .....	3.4	3.6	pF

Without External Shield

With External Shield\*

Diode-No.2 Cathode, Internal Shield (pin 3) to All Other Electrodes, and Heater .....	7.5	8.5*	pF
Triode Grid to any Diode Plate .....	0.034 max	0.034 max	pF

- # The dc component must not exceed 100 volts.
- With external shield connected to pin 7 except as noted.
- With external shield connected to pin 3.
- With external shield connected to pins 4 and 5.

**Triode Unit as Class A<sub>1</sub> Amplifier**

**MAXIMUM RATINGS (Design-Maximum Values):**

Plate Voltage .....	330 max	volts
Grid Voltage, Positive-bias value .....	0 max	volts
Plate Dissipation .....	1.1 max	watts

**CHARACTERISTICS:**

Plate Voltage .....	100	250	volts
Grid Voltage .....	-1	-3	volts
Amplification Factor .....	70	70	
Plate Resistance (Approx.) .....	54000	58000	ohms
Transconductance .....	1300	1200	$\mu$ mhos
Plate Current .....	0.8	1.0	mA

**Diode Units**

**MAXIMUM RATINGS (Design-Maximum Values):**

Plate Current (Each Unit) .....	5.5 max	mA
---------------------------------	---------	----

**AVERAGE PLATE CHARACTERISTICS**  
TRIODE UNIT

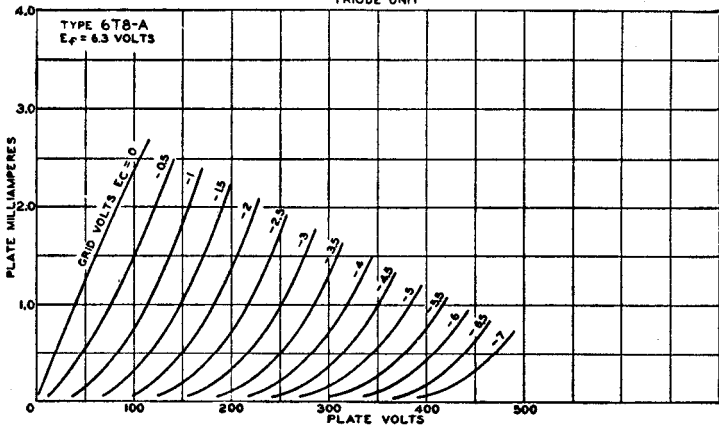

92CM-7063T

**HIGH-MU TRIODE—  
POWER PENTODE**

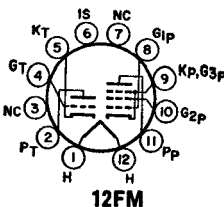

Duodecar type used in audio-frequency circuits. The triode unit is used as a voltage amplifier; the pentode unit is used as a power amplifier. Outline 8B, Outlines section. Tube requires duodecar twelve-contact socket

**6T9**

and may be mounted in any position. Heater volts (ac/dc), 6.3; amperes, 0.93; peak heater-cathode volts, 200 (the dc component must not exceed 100 volts when the heater is positive with respect to the cathode).

Class A<sub>1</sub> Amplifier

MAXIMUM RATINGS (Design-Maximum Values):		Triode Unit	Pentode Unit	
Plate Voltage		300 max	275 max	volts
Grid-No.2 (Screen-Grid) Voltage		—	275 max	volts
Grid-No.1 (Control-Grid) Voltage, Positive-bias value		0 max	0 max	volts
Plate Dissipation		1.5 max	12 max	watts
Grid-No.2 Input		—	2 max	watts

## CHARACTERISTICS (Triode Unit):

Plate Voltage	250	volts
Grid Voltage	-2	volts
Amplification Factor	95	
Plate Resistance (Approx.)	45000	ohms
Transconductance	2100	$\mu$ mhos
Plate Current	1.5	mA

## TYPICAL OPERATION (Pentode Unit):

Plate Voltage	250	volts
Grid-No.2 Voltage	250	volts
Grid-No.1 Voltage	-8	volts
Peak AF Grid-No.1 Voltage	8	volts
Zero-Signal Plate Current	35	mA
Maximum-Signal Plate Current	39	mA
Zero-Signal Grid-No.2 Current	2.5	mA
Maximum-Signal Grid-No.2 Current	7	mA
Plate Resistance (Approx.)	0.1	megohm
Transconductance	6500	$\mu$ mhos
Load Resistance	5000	ohms
Total Harmonic Distortion (Approx.)	10	per cent
Maximum-Signal Power Output	4.2	watts

## MAXIMUM CIRCUIT VALUES:

	Triode Unit	Pentode Unit	
Grid-No.1-Circuit Resistance:			
For fixed-bias operation	0.5 max	0.25 max	megohm
For cathode-bias operation	1*max	0.5 max	megohm

\* For cathode-bias operation of the triode unit, a maximum resistance of 10 megohms can be used provided the plate dissipation never exceeds 0.25 watt.

### BEAM POWER TUBE— SHARP-CUTOFF PENTODE

## 6T10

Duodecar type used as combined FM detector and audio-frequency output amplifier in television receivers. The beam power unit is used in af output stages, and the sharp-cutoff, dual-control pentode unit is used as an FM

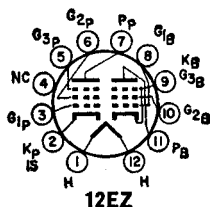

12EZ

detector. Outline 8B, **Outlines** section. Tube requires duodecar twelve-contact socket and may be mounted in any position. Heater volts (ac/dc), 6.3; amperes, 0.95; peak heater-cathode volts, 200 (the dc component must not exceed 100 volts when the heater is positive with respect to the cathode). For maximum ratings and characteristics, refer to type 6AL11.

### MEDIUM-MU TRIODE— SHARP-CUTOFF PENTODE

## 6U8A

Related types  
5U8, 9U8A

Miniature type used as combined oscillator and mixer tube in television receivers utilizing an intermediate frequency in the order of 40 megacycles per second. This type has a controlled heater warm-up time for use in tele-

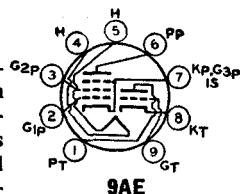

9AE

vision receivers employing series-controlled heater strings. Outline 6B, **Outlines** section. Tube requires miniature nine-contact socket and may be mounted in any position. Types 5U8 and 9U8A are identical with type 6U8A except for the heater ratings, as shown below.

	5U8	6U8A	9U8A	
Heater Voltage (ac/dc) .....	4.7	6.3	9.45	volts
Heater Current .....	0.6	0.45	0.3	ampere
Heater Warm-up Time (Average) .....	11	11	11	seconds
<b>Peak Heater-Cathode Voltage:</b>				
Heater negative with respect to cathode ...	200 max	200 max	200 max	volts
Heater positive with respect to cathode ...	200•max	200•max	200•max	volts
<b>Direct Interelectrode Capacitances:</b>				
<b>Triode Unit:</b>				
Grid to Plate .....		1.8	1.8	pF
Grid to Cathode, Heater, Pentode Cathode, Pentode Grid No.3, and Internal Shield .....		2.8	2.8	pF
Plate to Cathode, Heater, Pentode Cathode, Pentode Grid No.3, and Internal Shield .....		1.5	2	pF
<b>Pentode Unit:</b>				
Grid No.1 to Plate .....		0.010 max	0.006 max	pF
Grid No.1 to Cathode, Heater, Grid No.2, Grid No.3, and Internal Shield .....		5.0	5.0	pF
Plate to Cathode, Heater, Grid No.2, Grid No.3, and Internal Shield .....		2.6	3.5	pF
Triode Cathode to Heater .....		3	3•	pF
Pentode Cathode, Pentode Grid No.3, and Internal Shield to Heater .....		3	3•	pF
Pentode Grid No.1 to Triode Plate .....		0.2 max	0.2 max	pF
Pentode Plate to Triode Plate .....		0.1 max	0.02 max	pF

- The dc component must not exceed 100 volts.
- ▲ With external shield connected to pin 4 except as noted.
- With external shield connected to pin 6.

**Class A<sub>1</sub> Amplifier**

<b>MAXIMUM RATINGS (Design-Maximum Values):</b>	Triode Unit	Pentode Unit	
Plate Voltage .....	330 max	330 max	volts
Grid-No.2 (Screen-Grid) Supply Voltage .....	—	330 max	volts
Grid-No.2 Voltage .....	—	See curve page 80	
Grid-No.1 (Control-Grid) Voltage, Positive-bias value ..	0 max	0 max	volts
Plate Dissipation .....	2.5 max	3 max	watts
<b>Grid-No.2 Input:</b>			
For grid-No.2 voltages up to 165 volts .....	—	0.55 max	watt
For grid-No.2 voltages between 165 and 330 volts ..	—	See curve page 80	

<b>CHARACTERISTICS:</b>	Triode Unit	Pentode Unit	
Plate Voltage .....	125	125	volts
Grid-No.2 Voltage .....	—	110	volts
Grid-No.1 Voltage .....	-1	-1	volts
Amplification Factor .....	40	—	
Plate Resistance (Approx.) .....	—	0.2	megohm
Transconductance .....	7500	5000	μmhos
Grid-No.1 Voltage (Approx.) for plate current of 20 μA ..	-9	-8	volts
Plate Current .....	13.5	9.5	mA
Grid-No.2 Current .....	—	3.5	mA

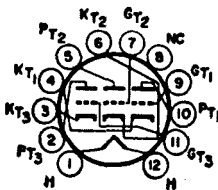

12FE

**THREE-UNIT TRIODE**

Duodecar type used in a variety of amplifier applications. Units No.1 and No.3 are medium-mu triode units, and unit No.2 is a high-mu triode unit. Outline 8A, **Outlines** section. Tube requires duodecar twelve-contact socket

**6U10**

and may be mounted in any position. Heater volts (ac/dc), 6.3; amperes, 0.6; warm-up time (average), 11 seconds; peak heater-cathode volts, 200 (this value may reach 275 for units No.1 and No.3 when the heater is negative with respect to the cathode; the dc component must not exceed 100 volts).

### Class A<sub>1</sub> Amplifier

	Units Nos. 1 and 3	Unit No.2	
<b>MAXIMUM RATINGS (Design-Maximum Values):</b>			
Plate Voltage .....	330 max	330 max	volts
DC Grid Voltage:			
Positive-bias value .....	0 max	0 max	volts
Negative-bias value .....	-50 max	-50 max	volts
Average Cathode Current .....	20 max	—	mA
Plate Dissipation .....	2 max	1 max	watts
<b>CHARACTERISTICS:</b>			
Plate Voltage .....	200	200	volts
Grid Voltage .....	-6	-1.5	volts
Amplification Factor .....	17.5	90	
Plate Resistance (Approx.) .....	7700	61000	ohms
Transconductance .....	2300	1600	μmhos
Plate Current .....	9.6	1.2	mA
Grid Voltage (Approx.):			
For plate current of 100 μA .....	-15	—	volts
For plate current of 35 μA .....	—	-3	volts
<b>MAXIMUM CIRCUIT VALUES:</b>			
Grid-Circuit Resistance:			
For fixed-bias operation .....	1 max	0.5 max	megohm
For cathode-bias operation .....	2.2 max	1*max	megohms

\* This value may reach 10 megohms provided the plate-supply voltage and load resistance are such that the plate dissipation can never exceed 0.5 watt.

## HALF-WAVE VACUUM RECTIFIER

# 6V3A

Miniature type used as a damper tube in horizontal deflection circuits of television receivers. Outline 7B, **Outlines** section. Tube requires miniature nine-contact socket and may be mounted in any position. It is especially important

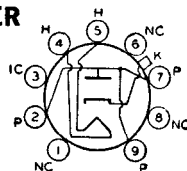

# 9BD

that this tube, like other power-handling tubes, be adequately ventilated. Heater volts (ac/dc), 6.3; amperes, 1.75.

### Damper Service

For operation in a 525-line, 30-frame system

<b>MAXIMUM RATINGS (Design-Center Values):</b>		
Peak Inverse Plate Voltage# (Absolute Maximum) .....	6000† max	volts
Peak Plate Current .....	800 max	mA
DC Plate Current .....	135 max	mA
<b>Peak Heater-Cathode Voltage:</b>		
Heater negative with respect to cathode# (Absolute Maximum) ..	6750†*max	volts
Heater positive with respect to cathode .....	300° max	volts

# The duration of the voltage pulse must not exceed 15 per cent of one horizontal scanning cycle. In a 525-line, 30-frame system, 15 per cent of one horizontal scanning cycle is 10 microseconds.

† Under no circumstances should this absolute value be exceeded.

° The dc component must not exceed 750 volts.

° The dc component must not exceed 100 volts.



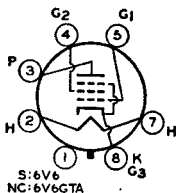

**BEAM POWER TUBE**

Metal type 6V6 and glass octal type 6V6GTA are used as output amplifiers in automobile, battery-operated, and other receivers in which reduced plate-current drain is desirable. Outlines 2B and 13D, respectively, **Outlines** section.

**6V6  
6V6GTA**

Related types:  
**5V6GT, 12V6GT**

**TAC**

Tubes require octal socket and may be mounted in any position. These tubes are equivalent in performance to type 6AQ5A. Refer to type 6AQ5A for average plate characteristic curves. Types 5V6GT and 12V6GT are identical with type 6V6GTA except for the heater ratings, as shown below.

	5V6GT	6V6	6V6GTA	12V6GT	
Heater Voltage (ac/dc) .....	4.7	6.3	6.3	12.6	volts
Heater Current .....	0.6	0.45	0.45	0.225	ampere
Heater Warm-up Time (Average) ..	11	—	11	—	seconds
<b>Peak Heater-Cathode Voltage:</b>					
Heater negative with respect to cathode .....	200 max	200 max	200 max	200 max	volts
Heater positive with respect to cathode .....	200*max	200*max	200*max	200*max	volts
<b>Direct Interelectrode Capacitances (Approx.):</b>					
Grid No.1 to Plate .....			6V6° 0.3	6V6GTA 0.7	pF
Grid No.1 to Cathode, Heater, Grid No.2, and Grid No.3 .....			10	9.0	pF
Plate to Cathode, Heater, Grid No.2, and Grid No.3 .....			11	7.5	pF

\* The dc component must not exceed 100 volts.

° With shell connected to cathode.

**Class A<sub>1</sub> Amplifier**

**MAXIMUM RATINGS (Design-Maximum Values):**

Plate Voltage .....	350 max	volts
Grid-No.2 (Screen-Grid) Voltage .....	315 max	volts
Plate Dissipation .....	14 max	watts
Grid-No.2 Input .....	2.2 max	watts

**TYPICAL OPERATION:**

Plate Voltage .....	180	250	315	volts
Grid-No.2 Voltage .....	180	250	225	volts
Grid-No.1 (Control-Grid) Voltage .....	-8.5	-12.5	-13	volts
Peak AF Grid-No.1 Voltage .....	8.5	12.5	13	volts
Zero-Signal Plate Current .....	29	45	34	mA
Maximum-Signal Plate Current .....	30	47	35	mA
Zero-Signal Grid-No.2 Current .....	3	4.5	2.2	mA
Maximum-Signal Grid-No.2 Current .....	4	7	6	mA
Plate Resistance (Approx.) .....	50000	50000	80000	ohms
Transconductance .....	3700	4100	3750	μmhos
Load Resistance .....	5500	5000	8500	ohms
Total Harmonic Distortion .....	8	8	12	per cent
Maximum-Signal Power Output .....	2	4.5	5.5	watts

**CHARACTERISTICS (Triode Connection):<sup>A</sup>**

Plate Voltage .....	250	volts
Grid-No.1 (Control-Grid) Voltage .....	-12.5	volts
Amplification Factor .....	9.8	
Plate Resistance (Approx.) .....	1960	ohms
Transconductance .....	5000	μmhos
Plate Current .....	49.5	mA
Grid-No.1 Voltage (Approx.) for plate current of 0.5 mA .....	-36	volts

<sup>A</sup> Grid No.2 connected to plate.

**Push-Pull Class A<sub>1</sub> Amplifier****MAXIMUM RATINGS** (Same as for class A<sub>1</sub> amplifier)**TYPICAL OPERATION** (Values are for two tubes):

Plate Voltage	250	285	volts
Grid-No.2 Voltage	250	285	volts
Grid-No.1 (Control-Grid) Voltage	-15	-19	volts
Peak AF Grid-No.1-to-Grid-No.1 Voltage	30	38	volts
Zero-Signal Plate Current	70	70	mA
Maximum-Signal Plate Current	79	92	mA
Zero-Signal Grid-No.2 Current	5	4	mA
Maximum-Signal Grid-No.2 Current	13	13.5	mA
Effective Load Resistance (Plate-to-Plate)	10000	8000	ohms
Total Harmonic Distortion	5	3.5	per cent
Maximum-Signal Power Output	10	14	watts

**MAXIMUM CIRCUIT VALUES:**

Grid-No.1-Circuit Resistance:			
For fixed-bias operation		0.1 max	megohm
For cathode-bias operation		0.5 max	megohm

**Vertical Deflection Amplifier (Triode Connection)<sup>†</sup>**

For operation in a 525-line, 30-frame system

**MAXIMUM RATINGS** (Design-Maximum Values):

DC Plate Voltage	350 max	volts
Peak Positive-Pulse Plate Voltage <sup>#</sup>	1200 max	volts
Peak Negative-Pulse Grid-No.1 (Control-Grid) Voltage	275 max	volts
Peak Cathode Current	115 max	mA
Average Cathode Current	40 max	mA
Plate Dissipation	10 max	watts

**MAXIMUM CIRCUIT VALUE:**

Grid-No.1-Circuit Resistance:		
For cathode-bias operation	2.2 max	megohms

<sup>†</sup> Grid No.2 connected to plate.<sup>#</sup> The duration of the voltage pulse must not exceed 15 per cent of one vertical scanning cycle. In a 525-line, 30-frame system, 15 per cent of one vertical scanning cycle is 2.5 milliseconds.**HALF-WAVE VACUUM RECTIFIER****6W4GT**

Glass octal type used as damper tube in television receivers. Outline 13D, **Outlines** section. This type may be supplied with pin No.1 omitted. Tube requires octal socket and may be mounted in any position. Socket terminals 1, 2, 4, and 6 should not be used as tie points. It is especially important that this tube, like other power-handling tubes, be adequately ventilated. Power-rectifier operation of this type is not recommended.

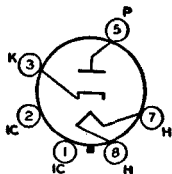
**4CG**

Heater Voltage (ac)	1.2	amperes
Heater Current	6.3	volts
Direct Interelectrode Capacitances (Approx.):		
Plate to Cathode and Heater	6	pF
Cathode to Plate and Heater	13	pF
Heater to Cathode	7	pF

**Damper Service**

For operation in a 525-line, 30-frame system

**MAXIMUM RATINGS** (Design-Center Values):

Peak Inverse Plate Voltage (Absolute Maximum)*	3850 max	volts
Peak Plate Current	750 max	mA
DC Plate Current	125 max	mA

Plate Dissipation .....	3.5 max	watts
Peak Heater-Cathode Voltage:		
Heater negative with respect to cathode (Absolute Maximum)* ...	2300*max	volts
Heater positive with respect to cathode .....	300*max	volts

**CHARACTERISTICS, Instantaneous Value:**

Tube Voltage Drop for plate current of 250 mA .....	21	volts
---	----	-------

- \* The duration of the voltage pulse must not exceed 15 per cent of one horizontal scanning cycle. In a 525-line, 30-frame system, 15 per cent of one horizontal scanning cycle is 10 microseconds.
- The dc component must not exceed 500 volts.
- ▲ The dc component must not exceed 100 volts.

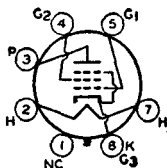

**7AC**

**BEAM POWER TUBE**

Glass octal type used in the audio output stage of radio and television receivers. Triode-connected, it is used as a vertical deflection amplifier in television receivers. Outline 13D, **Outlines** section. This type may be supplied

**6W6GT**  
Related type:  
**12W6GT**

with pin No.1 omitted. Tube requires octal socket and may be mounted in any position. Type 12W6GT is identical with type 6W6GT except for the heater ratings, as shown below.

	<b>6W6GT</b>	<b>12W6GT</b>	
Heater Voltage (ac/dc) .....	6.3	12.6	volts
Heater Current .....	1.2	0.6	ampere
Heater Warm-up Time (Average) .....	—	11	seconds
Peak Heater-Cathode Voltage:			
Heater negative with respect to cathode .....	200 max	300#max	volts
Heater positive with respect to cathode .....	200*max	200* max	volts
Direct Interelectrode Capacitances (Approx.):			
Grid No.1 to Plate .....		0.8	pF
Grid No.1 to Cathode, Heater, Grid No.2, and Grid No.3 .....		15	pF
Plate to Cathode, Heater, Grid No.2, and Grid. No.3 .....		9	pF

- # The dc component must not exceed 200 volts.
- The dc component must not exceed 100 volts.

**Class A<sub>1</sub> Amplifier**

**MAXIMUM RATINGS (Design-Maximum Values):**

Plate Voltage .....	330 max	volts
Grid-No.2 (Screen-Grid) Voltage .....	165 max	volts
Plate Dissipation .....	12 max	watts
Grid-No.2 Input .....	1.35 max	watts

**TYPICAL OPERATION:**

Plate Supply Voltage .....	110	200	volts
Grid-No.2 Supply Voltage .....	110	125	volts
Grid-No.1 (Control-Grid) Voltage .....	-7.5	—	volts
Cathode-Bias Resistor .....	—	180	ohms
Peak AF Grid-No.1 Voltage .....	7.5	8.5	volts
Zero-Signal Plate Current .....	49	46	mA
Maximum-Signal Plate Current .....	50	47	mA
Zero-Signal Grid-No.2 Current .....	4	2.2	mA
Maximum-Signal Grid-No.2 Current .....	10	8.5	mA
Plate Resistance (Approx.) .....	13000	28000	ohms
Transconductance .....	8000	8000	μmhos
Load Resistance .....	2000	4000	ohms
Total Harmonic Distortion (Approx.) .....	10	10	per cent
Maximum-Signal Power Output .....	2.1	3.8	watts

**CHARACTERISTICS (Triode Connection)\*:**

Plate Voltage .....	225	volts
Grid-No.1 Voltage .....	-30	volts
Amplification Factor .....	6.2	
Plate Resistance (Approx.) .....	1600	ohms

Transconductance .....	3800	$\mu$ hos
Plate Current .....	22	mA
Grid No.1 Voltage (Approx.) for plate current of 0.5 mA .....	-42	volts

**MAXIMUM CIRCUIT VALUES:**

Grid-No.1 Circuit Resistance:

For fixed-bias operation .....	0.1 max	megohm
For cathode-bias operation .....	0.5 max	megohm

\* Grid No. 2 connected to plate.

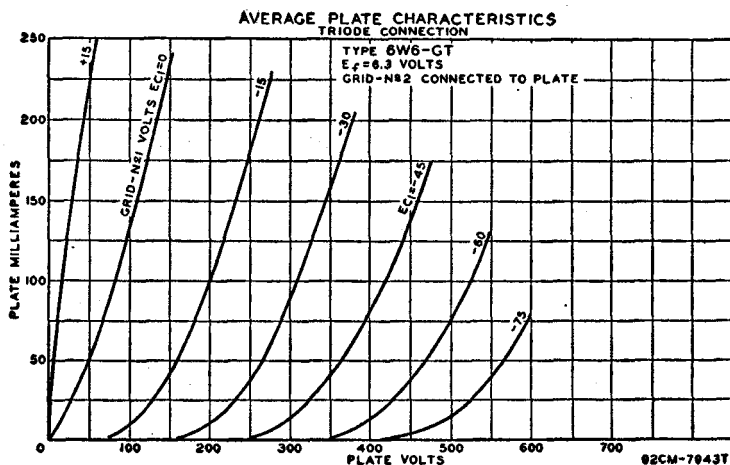
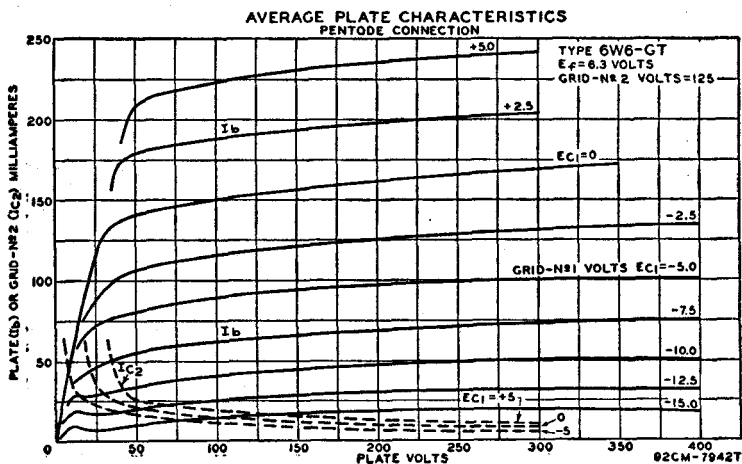
**Vertical Deflection Amplifier**

For operation in a 525-line, 30-frame system

**MAXIMUM RATINGS (Design-Maximum Values):**

	Triode Connection*	Pentode Connection	
DC Plate Voltage .....	330 max	330 max	volts
Peak Positive-Pulse Plate Voltage† .....	1200 max	1500 max	volts
DC Grid No.2 (Screen-Grid) Voltage .....	—	165 max	volts

Peak Negative-Pulse Grid-No.1 Voltage .....	-275 max	-275 max	volts
Peak Cathode Current .....	195 max	195 max	mA
Average Cathode Current .....	65 max	65 max	mA
Plate Dissipation .....	8.5 max	8 max	watts
Grid-No.2 Input .....	—	1.2 max	watts

**MAXIMUM CIRCUIT VALUE:**

Grid-No.1-Circuit Resistance:			
For cathode-bias operation .....	2.2 max	2.2 max	megohms

\* Grid No.2 connected to plate.

† The duration of the voltage pulse must not exceed 15 per cent of one vertical scanning cycle. In a 525-line, 30-frame system, 15 per cent of one vertical scanning cycle is 2.5 milliseconds.

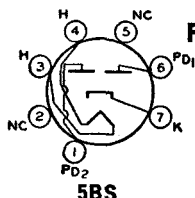

**FULL-WAVE VACUUM RECTIFIER**

Miniature type used in power supply of automobile and ac-operated radio receivers. Equivalent in performance to larger type 6X5GT. Type 6X4 requires miniature seven-contact socket and may be mounted in any position.

**6X4**

Related type:  
**12X4**

Outline 5D, Outlines section. It is especially important that this tube, like other power-handling tubes, be adequately ventilated. For discussion of Rating Chart and Operation Characteristics, refer to **Interpretation of Tube Data**. Type 12X4 is identical with type 6X4 except for the heater ratings, as shown below.

Heater Voltage (ac/dc) .....	6X4	12X4	
Heater Current .....	6.3 <sup>A</sup>	12.6	volts
Peak Heater-Cathode Voltage:			ampere
Heater negative with respect to cathode .....	450 max	450 max	volts
Heater positive with respect to cathode .....	200*max	200*max	volts

<sup>A</sup> When the heater is operated from a 3-cell (nominal-6-volt) storage-battery source, the permissible heater-voltage range is from 5 to 8 volts.

\* The dc component must not exceed 100 volts.

**Full-Wave Rectifier**

**MAXIMUM RATINGS (Design-Maximum Values):**

Peak Inverse Plate Voltage .....	1250 max	volts
Steady-State Peak Plate Current (Per Plate) .....	245 max	mA
AC Plate Supply Voltage (Per Plate, rms) .....	See Rating Chart	
DC Output Voltage (At filter input)† .....	350 max	volts
DC Output Current (Each plate)† .....	45 max	mA
Hot-Switching Transient Plate Current .....	#	

† This rating applies when the 6X4 is used in vibrator operation with a minimum duty cycle of 75 per cent.

# If hot-switching is regularly required in operation, the use of choke-input circuits is recommended. Such circuits limit the hot-switching current to a value no higher than that of the peak plate current. When capacitor-input circuits are used, a maximum peak current value per plate of 1.1 amperes during the initial cycles of the hot-switching transient should not be exceeded.

**TYPICAL OPERATION:**

	Sine-Wave Operation		Vibrator Operation	
	Capacitor	Choke	Capacitor	
AC Plate Supply Voltage (Each plate, rms)* ...	325	400	—	volts
Filter Input Capacitor .....	10	—	10	μF
Effective Plate Supply Impedance (Each plate) ..	525	—	—	ohms
Filter Input Choke .....	—	10	—	henries
DC Output Current .....	70	70	70	mA
DC Output Voltage at Input to Filter (Approx.)	310	340	240	volts

\* AC plate supply voltage is measured without load.

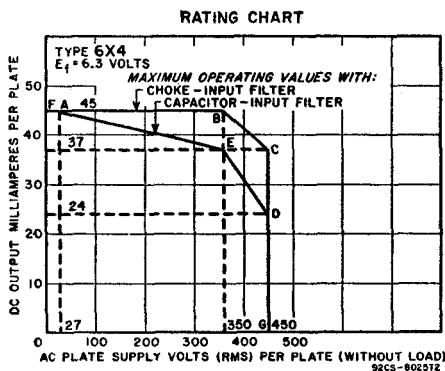
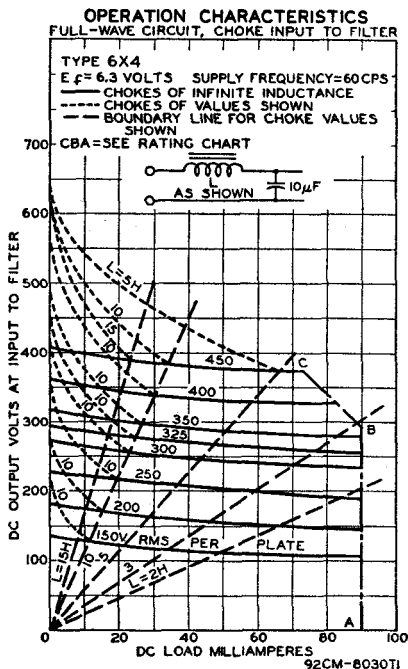
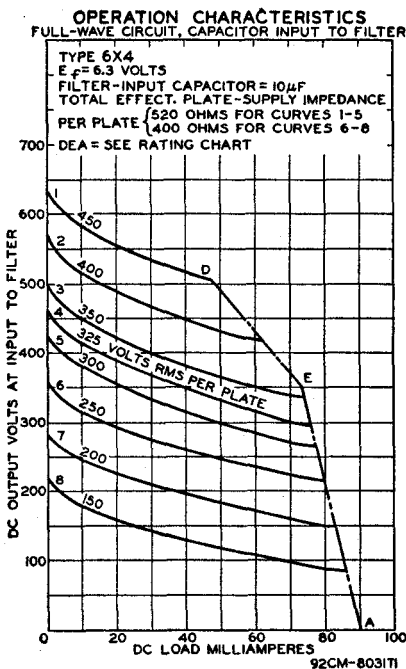

**FULL-WAVE VACUUM RECTIFIER**

**6X5GT**

Glass octal type used in power supply of automobile and ac-operated receivers. Outline 13D, **Outlines** section. This type may be supplied with pin No.1 omitted. Tube requires octal socket and may be operated in any position.

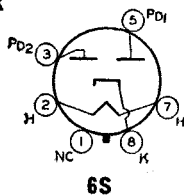

For maximum ratings, and typical operation, refer to type 6X4.

### MEDIUM-MU TRIODE— SHARP-CUTOFF PENTODE

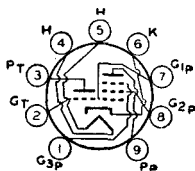

9AK

Miniature type used as combined oscillator and mixer tube in television receivers utilizing an intermediate frequency in the order of 40 megacycles per second. In such service, the 6X8 gives performance comparable to that

# 6X8

Related types:  
5X8, 19X8

obtainable with a 6AG5 mixer and an oscillator consisting of one unit of a type 6J6. When used in an AM/FM receiver, the triode unit is used as an oscillator for both sections. In the AM section, the pentode unit is used as a high-gain pentode mixer; in the FM section, the pentode unit is used either as a pentode mixer or as a triode-connected mixer depending on signal-to-noise considerations. Outline 6B, **Outlines** section. Tube requires miniature nine-contact socket and may be mounted in any position. Types 5X8 and 19X8 are identical with type 6X8 except for the heater ratings, as shown below.

	5X8	6X8	19X8	
Heater Voltage (ac/dc) .....	4.7	6.3	18.4	volts
Heater Current .....	0.6	0.45	0.15	ampere
Heater Warm-up Time (Average) .....	11	—	—	seconds
<b>Peak Heater-Cathode Voltage:</b>				
Heater negative with respect to cathode ...	200 max	200 max	200 max	volts
Heater positive with respect to cathode ...	200*max	200*max	200*max	volts
<b>Direct Interelectrode Capacitances:</b>				
<b>Triode Unit:</b>				
Grid to Plate .....		Without External Shield	With External Shield <sup>▲</sup>	
Grid to Cathode and Heater .....		1.5	1.5	pF
Plate to Cathode and Heater .....		2	2.4	pF
		0.5	1	pF
<b>Pentode Unit:</b>				
Grid No.1 to Plate .....		0.09 max	0.06 max	pF
Grid No.1 to Cathode, Heater, Grid No.2, and Grid No.3 .....		4.6	4.8	pF
Plate to Cathode, Heater, Grid No.2, and Grid No.3 .....		0.9	1.6	pF
Pentode Grid No.1 to Triode Plate .....		0.05 max	0.04 max	pF
Pentode Plate to Triode Plate .....		0.05 max	0.008 max	pF
Heater to Cathode .....		6.5	6.5*	pF

- The dc component must not exceed 100 volts.
- ▲ With external shield connected to cathode except as noted.
- With external shield connected to pentode plate.

AVERAGE PLATE CHARACTERISTICS  
TRIODE UNIT

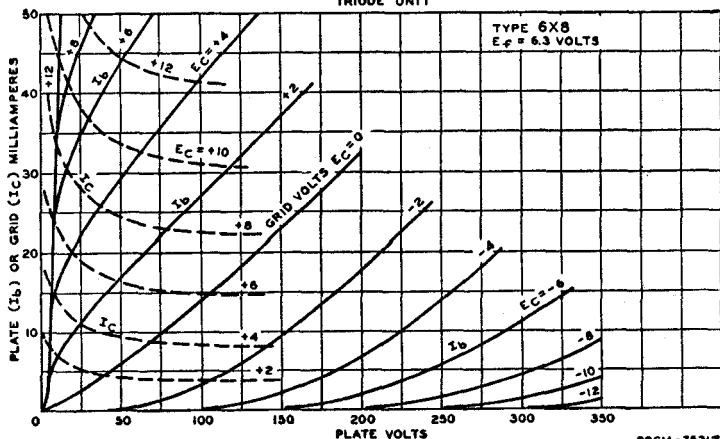

Class A<sub>1</sub> Amplifier

## MAXIMUM RATINGS (Design-Maximum Values):

	Triode Unit	Pentode Unit	
Plate Voltage	275 max	275 max	volts
Grid No.2 (Screen-Grid) Supply Voltage	—	275 max	volts
Grid-No.2 Voltage	—	See curve page 80	
Grid-No.1 (Control-Grid) Voltage, Positive-bias value	0 max	0 max	volts
Plate Dissipation	1.7 max	2.3 max	watts
Grid-No.2 Input:			
For grid-No.2 voltages up to 137.5 volts	—	0.45 max	watt
For grid-No.2 voltages between 137.5 and 275 volts	—	See curve page 80	

## CHARACTERISTICS:

	Triode Unit	Pentode Unit	
Plate Voltage	125	125	volts
Grid No.3	—	Connected to cathode at socket	
Grid-No.2 Voltage	—	125	volt
Grid-No.1 Voltage	-1	-1	volt
Amplification Factor	40	—	
Plate Resistance (Approx.)	12	9	mA
Transconductance	—	2.2	mA
Plate Current	6000	30000	ohms
Grid-No.2 Current	6500	5500	μmhos
Grid-No.1 Voltage (Approx.) for plate current of 10 μA	-7	-6.5	volts

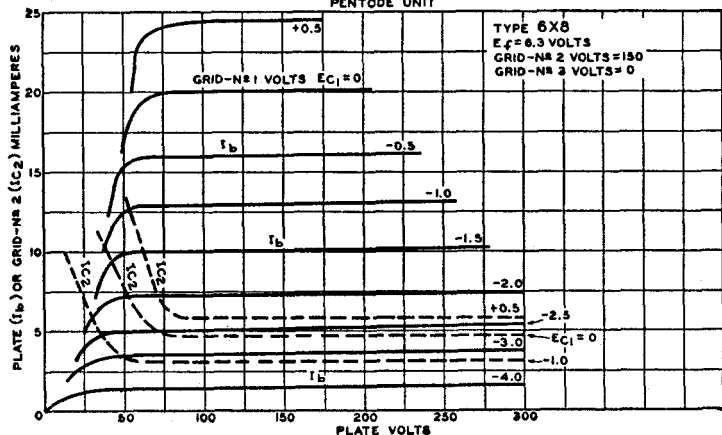
AVERAGE PLATE CHARACTERISTICS  
PENTODE UNIT

## BEAM POWER TUBE

**6Y6GA/  
6Y6G**

Glass octal type used as output amplifier in radio receivers. Also used in rf-operated, high-voltage power supplies in television equipment. Outline 19B, **Outlines** section. Tube requires octal socket and may be mounted in any position.

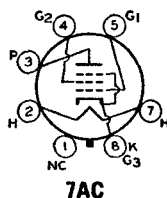

7AC

Heater Voltage (ac/dc)	6.3	volts
Heater Current	1.25	amperes
Peak Heater-Cathode Voltage:		
Heater negative with respect to cathode	180 max	volts
Heater positive with respect to cathode	180 max	volts
Direct Interelectrode Capacitances (Approx.):		
Grid No.1 to Plate	0.7	pF
Grid No.1 to Cathode, Heater, Grid No.2, and Grid No.3	12	pF



Plate to Cathode, Heater, Grid No.2, and Grid No.3 .....	7.5	pF
---	-----	----

**Class A<sub>1</sub> Amplifier**

**MAXIMUM RATINGS (Design-Center Values):**

Plate Voltage .....	200 max	volts
Grid-No.2 (Screen-Grid) Supply Voltage .....	200 max	volts
Grid-No.2 Voltage .....	See curve page 80	
Grid-No.2 Input:		
For grid-No.2 voltages up to 100 volts .....	1.75 max	watts
For grid-No.2 voltages between 100 and 200 volts .....	See curve page 80	
Plate Dissipation .....	12.5 max	watts

**TYPICAL OPERATION:**

Plate Voltage .....	135	200	volts
Grid-No.2 Voltage .....	135	135	volts
Grid-No.1 (Control-Grid) Voltage .....	-13.5	-14	volts
Peak AF Grid-No.1 Voltage .....	13.5	14	volts
Zero-Signal Plate Current .....	58	61	mA
Maximum-Signal Plate Current .....	60	66	mA
Zero-Signal Grid-No.2 Current .....	3.5	2.2	mA
Maximum-Signal Grid-No.2 Current .....	11.5	9	mA
Plate Resistance (Approx.) .....	9300	18300	ohms
Transconductance .....	7000	7100	μmhos
Load Resistance .....	2000	2600	ohms
Total Harmonic Distortion .....	10	10	per cent
Maximum-Signal Power Output .....	3.6	6	watts

**MAXIMUM CIRCUIT VALUES:**

Grid-No.1-Circuit Resistance:		
For fixed-bias operation .....	0.1 max	megohm
For cathode-bias operation .....	0.5 max	megohm

Refer to type 8FQ7/8CG7.

**8CG7**

**MEDIUM-MU TRIODE—  
SHARP-CUTOFF PENTODE**

**9A8  
9A8/  
PCF80**

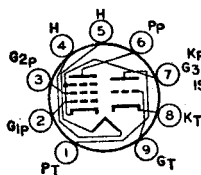

**9A8**

Miniature types used as combined oscillator and mixer tubes in vhf television receivers. Outline 6B, Outlines section. Tubes require miniature nine-contact socket and may be mounted in any position. Heater volts (ac/dc),

9; amperes, 0.3; peak heater-cathode volts, 200 (heater negative with respect to cathode, dc component must not exceed 120 volts), 100 volts (heater positive with respect to cathode).

**Class A<sub>1</sub> Amplifier**

**MAXIMUM RATINGS (Design-Center Values):**

Plate Supply Voltage .....	Triode Unit	Pentode Unit	
Plate Voltage .....	550 max	550 max	volts
Grid-No.2 (Screen-Grid) Voltage .....	250 max	250 max	volts
Cathode Current .....	—	175 max	volts
Plate Dissipation .....	14 max	14 max	mA
Grid-No.2 Input .....	1.5 max	1.7 max	watts
	—	0.5 max	watt

**CHARACTERISTICS:**

Plate Voltage .....	100	170	
Grid-No.2 Voltage .....	—	170	volts
Grid-No.1 Voltage .....	-2	-2	volts
Amplification Factor .....	20	47*	
Plate Resistance (Approx.) .....	—	0.4	megohm
Transconductance .....	5000	6200	μmhos
Plate Current .....	14	10	mA
Grid-No.2 Current .....	—	2.8	mA

**MAXIMUM CIRCUIT VALUES:**

Grid-No.1-Circuit Resistance:

For fixed-bias operation .....	0.5 max	0.5 max megohm
For cathode-bias operation .....	0.5 max	1 max megohm

\* Grid No.2 to Grid No.1.

**DUAL TRIODE****10EG7**

Glass octal type used as combined vertical-deflection oscillator and vertical-deflection amplifier in television receivers employing series-connected heater strings. Outline 13B, **Outlines** section. Tube requires octal socket

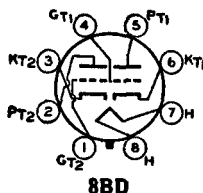
**8BD**

and may be operated in any position. Heater volts (ac/dc), 9.7; amperes, 0.6; warm-up time (average), 11 seconds; peak heater-cathode volts, 200 (the dc component must not exceed 100 volts when the heater is positive with respect to the cathode). For maximum ratings and characteristics, refer to type 6EW7.

**HIGH-MU TRIODE—  
SHARP-CUTOFF TETRODE****10JA8**

Miniature type used in color and black-and-white television receivers employing series-connected heater strings. The triode unit is used as a sync separator, sync clipper, and phase inverter; the tetrode unit is used as a

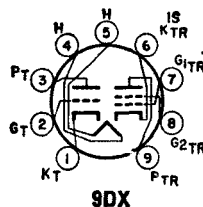
**9DX**

video amplifier. Outline 6E, **Outlines** section. Tube requires miniature nine-contact socket and may be mounted in any position. Heater volts (ac/dc), 10.5; amperes, 0.45; warm-up time (average), 11 seconds; peak heater-cathode volts, 200 (the dc component must not exceed 100 volts when the heater is positive with respect to the cathode).

**Class A<sub>1</sub> Amplifier****MAXIMUM RATINGS (Design-Maximum Values):**

	Triode Unit	Tetrode Unit	
Plate Voltage .....	300 max	330 max	volts
Grid-No.2 (Screen-Grid) Supply Voltage .....	—	330 max	volts
Grid-No.2 Voltage .....	—	See curve page 80	
Grid-No.1 (Control-Grid) Voltage, Positive-bias value .....	0 max	0 max	volts
Plate Dissipation .....	1 max	5 max	watts
Grid-No.2 Input:			
For grid-No.2 voltages up to 165 volts .....	—	1.5 max	watts
For grid-No.2 voltages between 165 and 330 volts .....	—	See curve page 80	

**CHARACTERISTICS:**

	Triode Unit		Tetrode Unit			
Plate Voltage .....	135	200	30	135	200	volts
Grid-No.2 Voltage .....	—	—	135	135	135	volts
Grid-No.1 Voltage .....	-2	-2	0	-1.5	-1.5	volts
Amplification Factor .....	60	70	—	—	—	
Plate Resistance .....	23000	17000	—	6600	7000	ohms
Transconductance .....	2600	4000	—	12600	14000	μmhos
Plate Current .....	2	4	32*	17	18	mA
Grid-No.2 Current .....	—	—	14*	4.2	4	mA
Grid-No.1 Voltage (Approx.) for plate current of 10 μA .....	-4.8	-7	—	-5	-5	volts

**MAXIMUM CIRCUIT VALUES:**

Grid-No.1-Circuit Resistance:	Triode Unit	Tetrode Unit
For fixed-bias operation .....	0.5 max	0.25 max megohm
For cathode-bias operation .....	1 max	1 max megohm

• This value can be measured by a method involving a recurrent waveform such that the maximum ratings of the tube will not be exceeded.

**MEDIUM-MU TRIODE—  
SHARP-CUTOFF PENTODE**

**10JY8**

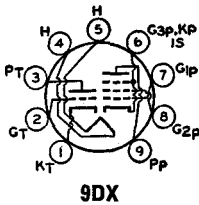

Miniature type used in a variety of applications in television receivers. The pentode unit is used as a video amplifier, and the triode unit as a sync separator. Outline 6E, **Outlines** section. Tube requires miniature nine-

contact socket and may be mounted in any position. Heater volts (ac/dc), 10.5; amperes, 0.45; warm-up time (average), 11 seconds; peak heater-cathode volts, 200 (the dc component must not exceed 100 volts when heater is positive with respect to cathode; this value may be 300 volts for the triode unit when heater is negative with respect to cathode, with a maximum peak value of 200 volts).

**Class A<sub>1</sub> Amplifier**

**MAXIMUM RATINGS (Design-Maximum Values):**

Plate Voltage .....	Triode Unit	Pentode Unit	
Grid-No.2 (Screen-Grid) Supply Voltage .....	330 max	330 max	volts
Grid-No.2 Voltage .....	—	330 max	volts
Grid-No.1 (Control-Grid) Voltage, Positive-bias value .....	—	—	See curve page 80
Plate Dissipation .....	0 max	0 max	volts
Grid-No.2 Input:	2 max	5 max	watts
For grid-No.2 voltages up to 165 volts .....	—	1.1 max	watts
For grid-No.2 voltages between 165 and 330 volts .....	—	—	See curve page 80

**CHARACTERISTICS:**

Plate Voltage .....	125	50	200	volts
Grid-No.2 Voltage .....	—	150	150	volts
Grid-No.1 Voltage .....	—	0	—	volts
Cathode-Bias Resistor .....	68	—	100	ohms
Amplification Factor .....	46	—	—	
Plate Resistance (Approx.) .....	4400	—	5500	ohms
Transconductance .....	10400	—	11000	μmhos
Plate Current .....	15	60 <sup>a</sup>	24	mA
Grid-No.2 Current .....	—	18 <sup>a</sup>	4.8	mA
Grid Voltage (Approx.) for plate current of 10 μA .....	-8	—	-10	volts

**MAXIMUM CIRCUIT VALUES:**

Grid-No.1-Circuit Resistance:	Triode Unit	Tetrode Unit
For fixed-bias operation .....	0.5 max	0.25 max megohm
For cathode-bias operation .....	1 max	1 max megohm

• This value can be measured by a method involving a recurrent waveform such that the maximum ratings of the tube will not be exceeded.

**MEDIUM-MU TRIODE—  
SHARP-CUTOFF PENTODE**

**11LQ8**

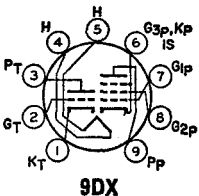

Miniature type with frame-grid pentode used in black-and-white television receivers employing low-voltage power supplies and series-connected heater strings. The triode unit is used in general-purpose voltage-amplifier circuits. The pentode unit is used in video-output circuits. Outline 6E, **Outlines** section. Tube requires miniature nine-

contact socket and may be mounted in any position.

Heater Voltage (ac/dc)	10.9	volts
Heater Current	0.45	ampere
Heater Warm-up Time (Average)	11	seconds
Peak Heater-Cathode Voltage:		
Heater negative with respect to cathode	200 max	volts
Heater positive with respect to cathode	200*max	volts
Direct Interelectrode Capacitances (Approx.):		
Triode Unit:		
Grid to Plate	2.8	pF
Grid to Triode Cathode, Pentode Cathode, Heater, Pentode Grid No.3, and Internal Shield	4.2	pF
Plate to Triode Cathode, Pentode Cathode, Heater, Pentode Grid No.3, and Internal Shield	2.4	pF
Pentode Unit:		
Grid No.1 to Plate	0.12 max	pF
Grid No.1 to Cathode, Heater, Grid No.2, Grid No.3, and Internal Shield	14	pF
Plate to Cathode, Heater, Grid No.2, Grid No.3, and Internal Shield	4.8	pF
Triode Grid to Pentode Plate	0.015 max	pF
Pentode Plate to Triode Plate	0.17 max	pF

\* The dc component must not exceed 100 volts.

**Class A<sub>1</sub> Amplifier**

<b>MAXIMUM RATINGS (Design-Maximum Values):</b>			
Plate Voltage	Triode Unit	Pentode Unit	
Grid-No.2 (Screen-Grid) Supply Voltage	300 max	300 max	volts
Grid-No.2 Voltage	—	300 max	volts
Grid-No.1 (Control-Grid) Voltage, Positive-bias value	—	See curve page 80	
Plate Dissipation	0 max	0 max	volts
Grid-No.2 Input:	2 max	5 max	watts
For grid-No.2 voltages up to 150 volts	—	1 max	watt
For grid-No.2 voltages between 150 and 300 volts	—	See curve page 80	

**CHARACTERISTICS:**

Plate Supply Voltage	125	125	200	volts
Grid-No.2 Supply Voltage	—	125	125	volts
Cathode-Bias Resistor	68	82	68	ohms
Amplification Factor	46	—	—	
Plate Resistance (Approx.)	4400	55000	75000	ohms
Transconductance	10400	21000	23000	μmhos
Plate Current	15	16.5	20	mA
Grid-No.2 Current	—	3.1	3.5	mA
Grid-No.1 Voltage (Approx.) for plate current of 100 μA	-6	-4.2	-4.2	volts

**AVERAGE PLATE CHARACTERISTICS**  
PENTODE SECTION

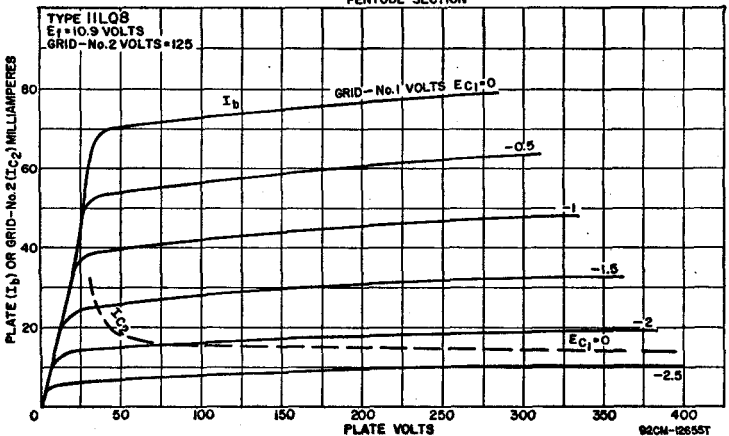

**MAXIMUM CIRCUIT VALUES:**

<b>Grid-No.1-Circuit Resistance:</b>			
For fixed-bias operation .....	0.5 max	0.1 max	megohm
For cathode-bias operation .....	1 max	0.25 max	megohm

**AVERAGE PLATE CHARACTERISTICS**  
TRIODE SECTION

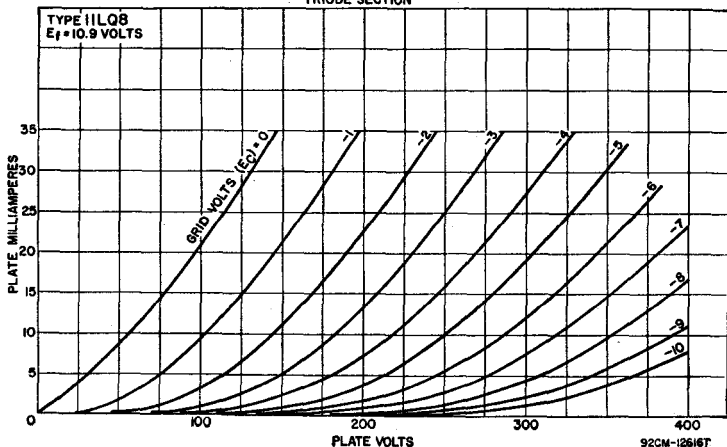

**BEAM POWER TUBE**

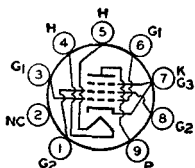

**9EU**

Miniature type used in the output stage of automobile radio receivers operating from a 12-volt storage battery. Outline 6E, **Outlines** section. Tube requires miniature nine-contact socket and may be mounted in any position.

**12AB5**

Heater-Voltage Range (ac/dc)* .....	10.0 to 15.9	volts
Heater Current (Approx.) at 12.6 volts .....	0.2	ampere
Peak Heater-Cathode Voltage:		
Heater negative with respect to cathode .....	90 max	volts
Heater positive with respect to cathode .....	90 max	volts
Direct Interelectrode Capacitances:		
Grid No.1 to Plate .....	0.7 max	pF
Grid No.1 to Cathode, Heater, Grid No.2, and Grid No.3 .....	8	pF
Plate to Cathode, Heater, Grid No.2, and Grid No.3 .....	8.5	pF

\* For longest life, it is recommended that the heater be operated within the voltage range of 11 to 14 volts.

**Class A<sub>1</sub> Amplifier**

**MAXIMUM RATINGS (Design-Center Values):**

Plate Voltage .....	315 max	volts
Grid-No.2 (Screen-Grid) Voltage .....	285 max	volts
Plate Dissipation .....	12 max	watts
Grid-No.2 Input .....	2 max	watts
Bulb Temperature (At hottest point) .....	250 max	°C

**TYPICAL OPERATION WITH 12.6 VOLTS ON HEATER:**

Plate Supply Voltage .....	250	250	volts
Grid-No.2 Supply Voltage .....	200	250	volts
Grid-No.1 (Control-Grid) Voltage .....	—	-12.5	volts
Cathode-Bias Resistor .....	270	—	ohms

Peak AF Grid-No.1 Voltage	10.5	12.5	volts
Zero-Signal Plate Current	33.5	45	mA
Maximum-Signal Plate Current	36	47	mA
Zero-Signal Grid-No.2 Current	1.6	4.5	mA
Maximum-Signal Grid-No.2 Current	3.2	7	mA
Plate Resistance (Approx.)	75000	50000	ohms
Transconductance	4000	4100	$\mu$ mhos
Load Resistance	6000	5000	ohms
Total Harmonic Distortion	8	8	per cent
Maximum-Signal Power Output	3.3	4.5	watts

**MAXIMUM CIRCUIT VALUES:**

Grid-No.1-Circuit Resistance:		
For fixed-bias operation	0.1 max	megohm
For cathode-bias operation	0.5 max	megohm

**Push-Pull Class AB<sub>1</sub> Amplifier**

**MAXIMUM RATINGS:** (Same as for single-tube class A<sub>1</sub> amplifier)

**TYPICAL OPERATION WITH 12.6 VOLTS ON HEATER** (Values are for two tubes):

Plate Voltage	250	volts
Grid-No.2 Voltage	250	volts
Grid-No.1 Voltage	-15	volts
Peak AF Grid-No.1-to-Grid-No.1 Voltage	30	volts
Zero-Signal Plate Current	70	mA
Maximum-Signal Plate Current	79	mA
Zero-Signal Grid-No.2 Current	5	mA
Maximum-Signal Grid-No.2 Current	13	mA

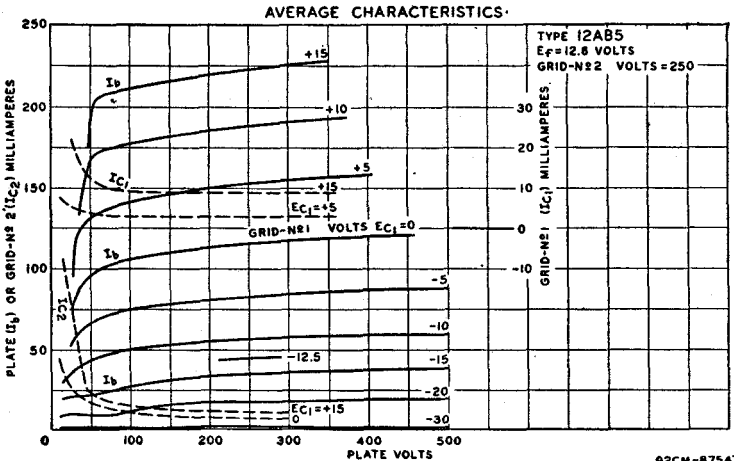

92CM-8754T

Effective Load Resistance (Plate-to-Plate)	10000	ohms
Total Harmonic Distortion	5	per cent
Maximum-Signal Power Output	10	watts

**MAXIMUM CIRCUIT VALUES:**

Grid-No.1-Circuit Resistance:		
For fixed-bias operation	0.1 max	megohm
For cathode-bias operation	0.5 max	megohm

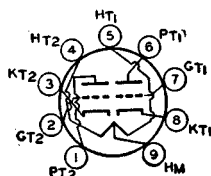

### HIGH-MU TWIN TRIODE

Miniature types used as push-pull cathode-drive amplifiers or frequency converters in the FM and television broadcast bands. Outline 6B, Outlines section. Tubes require miniature nine-contact socket and may be

**12A7**  
**12A7/**  
**ECC81**

**9A**  
mounted in any position. Each triode unit is independent of the other except for the common heater. For typical operation as a resistance-coupled amplifier, refer to **Resistance-Coupled Amplifier** section.

Heater Arrangement:	Series	Parallel	
Heater Voltage (ac/dc) .....	12.6	6.3	volts
Heater Current .....	0.15	0.3	ampere
Peak Heater-Cathode Voltage:			
Heater negative with respect to cathode .....		90 max	volts
Heater positive with respect to cathode .....		90 max	volts
Direct Interelectrode Capacitances:			
Grid-Drive Operation:			
Grid to Plate (Each unit) .....		1.5	pF
Grid to Cathode and Heater (Each unit) .....		2.2	pF
Plate to Cathode and Heater:			
Unit No.1 .....		0.5	pF
Unit No.2 .....		0.4	pF
Cathode-Drive Operation:			
Cathode to Plate (Each Unit) .....		0.2	pF
Cathode to Grid and Heater (Each unit) .....		4.6	pF
Plate to Grid and Heater (Each unit) .....		1.8	pF
Heater to Cathode (Each unit) .....		2.4	pF

#### Class A<sub>1</sub> Amplifier (Each Unit)

<b>MAXIMUM RATINGS (Design-Center Values):</b>			
Plate Voltage .....		300 max	volts
Grid Voltage, Negative-bias value .....		-50 max	volts
Plate Dissipation .....		2.5 max	watts
<b>CHARACTERISTICS:</b>			
Plate Supply Voltage .....	100	250	volts
Cathode-Bias Resistor .....	270	200	ohms
Amplification Factor .....	60	60	
Plate Resistance (Approx.) .....	15000	10900	ohms
Transconductance .....	4000	5500	μmhos
Grid Voltage (Approx.) for plate current of 10 μA .....	-5	-12	volts
Plate Current .....	3.7	10	mA

AVERAGE PLATE CHARACTERISTICS FOR EACH UNIT

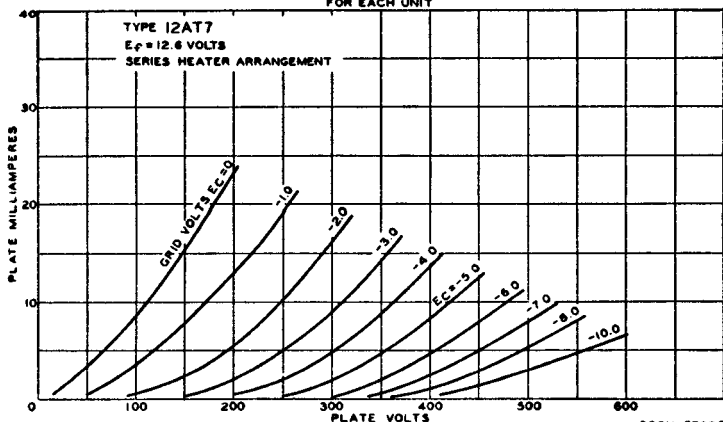

# 12AU7A MEDIUM-MU TWIN TRIODE

## 12AU7A/ ECC82

Related types:  
7AU7, 9AU7

Miniature types used as phase inverters or push-pull amplifiers in ac/dc radio equipment and in diversified applications such as multivibrators or oscillators in industrial control devices. Also used as combined vertical oscil-

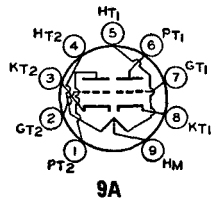

lators and vertical deflection amplifiers, and as horizontal deflection oscillators, in television receivers. These types are also useful in applications critical as to microphonics. Outline 6B, **Outlines** section. Tubes require miniature nine-contact socket and may be mounted in any position. Each triode unit is independent of the other except for the common heater. For typical operation as a resistance-coupled amplifier, refer to **Resistance-Coupled Amplifier** section. Types 7AU7 and 9AU7 are identical with types 12AU7A and 12AU7A/ECC82 except for the heater ratings, as shown below.

	7AU7	9AU7	12AU7A/ 12AU7A/ ECC82	
Heater Voltage (ac/dc):				
Series .....	7	9.4	12.6	volts
Parallel .....	3.5	4.7	6.3	volts
Heater Current:				
Series .....	0.3	0.225	0.15	ampere
Parallel .....	0.6	0.45	0.3	ampere
Heater Warm-up Time (Parallel, Average) .....	11	11	—	seconds
Peak Heater-Cathode Voltage:				
Heater negative with respect to cathode .....	200 max	200 max	200 max	volts
Heater positive with respect to cathode .....	200*max	200*max	200*max	volts
Direct Interelectrode Capacitances (Approx.):		Unit No.1	Unit No.2	
Grid to Plate .....		1.5	1.5	pF
Grid to Cathode and Heater .....		1.6	1.6	pF
Plate to Cathode and Heater .....		0.5	0.35	pF

\* The dc component must not exceed 100 volts.

### Class A<sub>1</sub> Amplifier (Each Unit Unless Otherwise Specified)

#### MAXIMUM RATINGS (Design-Maximum Values):

Plate Voltage .....	330 max	volts
Plate Dissipation:		
Each Plate .....	2.75 max	watts
Both Plates (Both units operating) .....	5.5 max	watts
Cathode Current .....	22 max	mA

#### CHARACTERISTICS:

Plate Voltage .....	100	250	volts
Grid Voltage .....	0	-8.5	volts
Amplification Factor .....	19.5	17	
Plate Resistance (Approx.) .....	6250	7700	ohms
Transconductance .....	3100	2200	μmhos
Plate Current .....	11.8	10.5	mA
Grid Voltage (Approx.) for plate current of 10 μA .....	—	-24	volts

#### MAXIMUM CIRCUIT VALUES:

Grid-Circuit Resistance:		
For fixed-bias operation .....	0.25 max	megohm
For cathode-bias operation .....	1.0 max	megohm

### Oscillator (Each Unit Unless Otherwise Specified)

For operation in a 525-line, 30-frame system

	Vertical- Deflection Oscillator	Horizontal- Deflection Oscillator	
MAXIMUM RATINGS (Design-Maximum Values):			
DC Plate Voltage .....	330 max	330 max	volts
Peak Negative-Pulse Grid Voltage .....	-440 max	-660 max	volts
Peak Cathode Current .....	66 max	330 max	mA
Average Cathode Current .....	22 max	22 max	mA
Plate Dissipation:			
Each Plate .....	2.75 max	2.75 max	watts
Both Plates (Both units operating) .....	5.5 max	5.5 max	watts



**MAXIMUM CIRCUIT VALUE:**

Grid-Circuit Resistance ..... 2.2 max 2.2 max megohms

**Vertical-Deflection Amplifier (Each Unit Unless Otherwise Specified)**

For operation in a 525-line, 30-frame system

**MAXIMUM RATINGS (Design-Maximum Values):**

DC Plate Voltage .....	330 max	volts
Peak Positive-Pulse Plate Voltage# .....	1200 max	volts
Peak Negative-Pulse Grid Voltage .....	-275 max	volts
Peak Cathode Current .....	66 max	mA
Average Cathode Current .....	22 max	mA
Plate Dissipation:		
Each Plate .....	2.75 max	watts
Both Plates (Both units operating) .....	5.5 max	watts

**MAXIMUM CIRCUIT VALUES:**

Grid-Circuit Resistance: For cathode-bias operation ..... 2.2 max megohms

# The duration of the voltage pulse must not exceed 15 per cent of one vertical scanning cycle. In a 525-line, 30-frame system, 15 per cent of one vertical scanning cycle is 2.5 milliseconds.

**AVERAGE PLATE CHARACTERISTICS EACH UNIT**

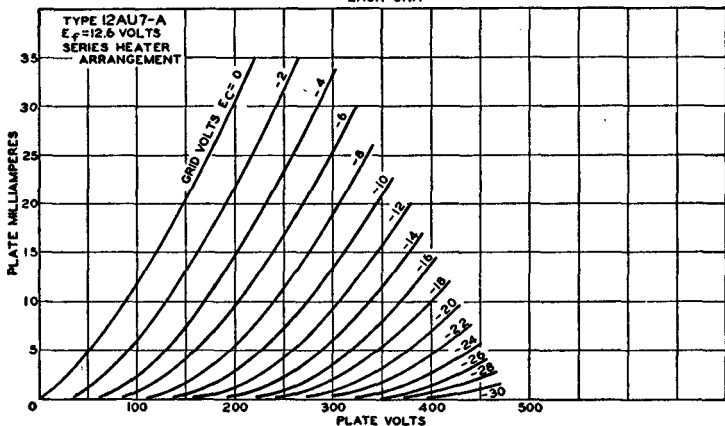

92CM-105487

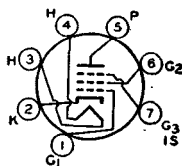

**7CM**

**SHARP-CUTOFF PENTODE**

Miniature type used as an rf or if amplifier up to 400 megacycles in compact ac/dc FM receivers. Outline 5C, Outlines section. Tube requires miniature seven-contact socket. Heater volts (ac/dc), 12.6; amperes, 0.15. Ex-

**12AW6**

cept for heater ratings and terminal connections, this type is identical with miniature type 6AG5.

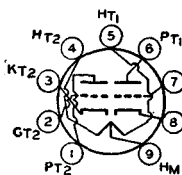

**9A**

**HIGH-MU TWIN TRIODE**

Miniature types used as phase inverters or twin resistance-coupled amplifiers in radio equipment. These types have controlled hum and noise characteristics and are used in high-fidelity audio-amplifier applications. Outline

**12AX7A**  
**12AX7A/**  
**ECC83**

6B, **Outlines** section. Tubes require miniature nine-contact socket and may be mounted in any position. Each triode unit is independent of the other except for common heater. For characteristics and curves, refer to type 6AV6. For typical operation as a resistance-coupled amplifier, refer to **Resistance-Coupled Amplifier** section.

Heater Arrangement:	<b>Series</b>	<b>Parallel</b>	
Heater Voltage (ac/dc) .....	12.6	6.3	volts
Heater Current .....	0.15	0.3	ampere
<b>Peak Heater-Cathode Voltage:</b>			
Heater negative with respect to cathode .....		200 max	volts
Heater positive with respect to cathode .....		200*max	volts
<b>Direct Interelectrode Capacitances (Approx.):</b>			
	<b>Unit No.1</b>	<b>Unit No.2</b>	
Grid to Plate (Each unit) .....	1.7	1.7	pF
Grid to Cathode and Heater (Each unit) .....	1.6	1.6	pF
Plate to Cathode and Heater .....	0.46	0.34	pF

\* The dc component must not exceed 100 volts.

### Class A<sub>1</sub> Amplifier (Each Unit)

#### MAXIMUM RATINGS (Design-Maximum Values):

Plate Voltage .....	330 max	volts
Plate Dissipation .....	1.2 max	watts
<b>Grid Voltage:</b>		
Negative-bias value .....	-55 max	volts
Positive-bias value .....	0 max	volts

#### EQUIVALENT NOISE AND HUM VOLTAGE (Reference to Grid, Each Unit):\*

Average Value .....	1.8	$\mu$ V rms
---------------------	-----	-------------

\* Measured in "true rms" units under the following conditions: Heater voltage (parallel connection), 6.3 volts ac; center tap of heater transformer grounded; plate supply voltage, 250 volts dc; plate load resistor, 100000 ohms; cathode resistor, 2700 ohms bypassed by 100- $\mu$ F capacitor; grid resistor, 0 ohms; and amplifier covering frequency range between 25 and 10000 c/s.

### MEDIUM-MU TWIN TRIODE

# 12AY7

Miniature type used in the first stages of high-gain audio-frequency amplifiers where reduction of microphonics, leakage noise, and hum are primary considerations. Outline 6B, **Outlines** section. Tube requires miniature nine-

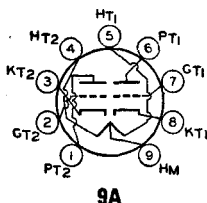

contact socket and may be mounted in any position. Each triode unit is independent of the other except for the common heater. Use of the 12.6-volt connection with an ac heater supply is not recommended for applications involving low hum. For typical operation as a resistance-coupled amplifier, refer to **Resistance-Coupled Amplifier** section.

Heater Arrangement:	<b>Series</b>	<b>Parallel</b>	
Heater Voltage (ac/dc) .....	12.6	6.3	volts
Heater Current .....	0.15	0.3	ampere
<b>Peak Heater-Cathode Voltage:</b>			
Heater negative with respect to cathode .....		90 max	volts
Heater positive with respect to cathode .....		90 max	volts
Amplification Factor (Each unit)* .....		44	
Plate Resistance (Each unit, approx.)* .....		25000	ohms
Transconductance* .....		1750	$\mu$ mhos

\* For plate volts, 250; grid volts, -4; plate mA, 3.

### Class A<sub>1</sub> Amplifier (Each Unit)

#### MAXIMUM RATINGS (Design-Center Values):

Plate Voltage .....	300 max	volts
---------------------	---------	-------

Grid Voltage:		
Negative bias value .....	-50 max	volts
Positive bias value .....	0 max	volts
Plate Dissipation .....	1.5 max	watts
Cathode Current .....	10 max	mA

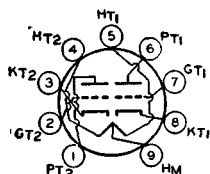

### HIGH-MU TWIN TRIODE

Miniature type used in direct-coupled cathode-drive rf amplifier circuits of vhf television tuners. Outline 6B, **Outlines** section. Tube requires miniature nine-contact socket and may be mounted in any position. For characteristics, class A<sub>1</sub> amplifier, refer to miniature type 12AT7.

## 12AZ7A

Heater Voltage (ac/dc):			
Series .....	12.6	volts	
Parallel .....	6.3	volts	
Heater Current:			
Series .....	0.225	ampere	
Parallel .....	0.45	ampere	
Heater Warm-up Time (Average) .....	11	seconds	
Peak Heater-Cathode Voltage:			
Heater negative with respect to cathode .....	200 max	volts	
Heater positive with respect to cathode .....	200 <sup>o</sup> max	volts	
	Without External Shield	With External Shield <sup>Δ</sup>	
Direct Interelectrode Capacitance (Approx.):			
Grid to Plate (Each unit) .....	2	1.9	pF
Grid to Cathode and Heater (Each unit) .....	2.6	2.8	pF
Plate to Cathode and Heater:			
Unit No.1 .....	0.44	1.4	pF
Unit No.2 .....	0.36	1.6	pF

\* The dc component must not exceed 100 volts.

Δ With external shield connected to cathode of unit under test.

### Class A<sub>1</sub> Amplifier (Each Unit)

**MAXIMUM RATINGS** (Design-Maximum Values):

Plate Voltage .....	330 max	volts
Grid Voltage, Negative-bias value .....	-55 max	volts
Plate Dissipation .....	2.5 max	watts

**MAXIMUM CIRCUIT VALUES** (Each Unit):

Grid-Circuit Resistance:		
For fixed-bias operation .....	0.25 max	megohm
For cathode-bias operation .....	1 max	megohm

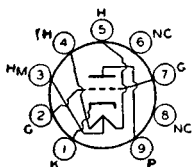

### LOW-MU TRIODE

Miniature type having high perveance used as vertical deflection amplifier in television receivers. This type has a controlled heater warm-up time for use in series-connected heater strings. Outline 6E, **Outlines** section.

## 12B4A

Tube requires miniature nine-contact socket and may be mounted in any position. Heater volts (ac/dc), 12.6 (series), 6.3 (parallel); amperes, 0.3 (series), 0.6 (parallel); warm-up time (average), 11 seconds; peak heater-cathode volts, 200 (the dc component must not exceed 100 volts when the heater is positive with respect to the cathode).

Class A<sub>1</sub> Amplifier

## MAXIMUM RATINGS (Design-Center Values):

Plate Voltage	550 max	volts
Grid Voltage, Negative-bias value	-50 max	volts
Plate Dissipation	5.5 max	watts

## CHARACTERISTICS:

Plate Voltage	150	volts
Grid Voltage	-17.5	volts
Amplification Factor	6.5	
Plate Resistance (Approx.)	1030	ohms
Transconductance	6300	μmhos
Plate Current	34	mA
Grid Voltage (Approx.) for plate current of 200 μA	-32	volts
Plate Current for grid voltage of -23 volts	9.6	mA

## MAXIMUM CIRCUIT VALUES:

Grid-Circuit Resistance:		
For fixed-bias operation	0.47 max	megohm
For cathode-bias operation	2.2 max	megohms

## Vertical Deflection Amplifier

For operation in a 525-line, 30-frame system

## MAXIMUM RATINGS (Design-Center Values):

DC Plate Voltage	550 max	volts
Peak Positive-Pulse Plate Voltage* (Absolute Maximum)	1000†max	volts
Peak Negative-Pulse Grid Voltage	-250 max	volts
Peak Cathode Current	105 max	mA
Average Cathode Current	30 max	mA
Plate Dissipation	5.5 max	watts

## MAXIMUM CIRCUIT VALUE:

Grid-Circuit Resistance:		
For cathode-bias operation	2.2 max	megohms

\* The duration of the voltage pulse must not exceed 15 per cent of one vertical scanning cycle. In a 525-line, 30-frame system, 15 per cent of one vertical scanning cycle is 2.5 milliseconds.

† Under no circumstances should this absolute value be exceeded.

## MEDIUM-MU TWIN TRIODE

12BH7A

Miniature type used as combined vertical deflection amplifier and vertical oscillator, and as horizontal deflection oscillator, in television receivers. This type has a controlled heater warm-up time for use in series-connected heater

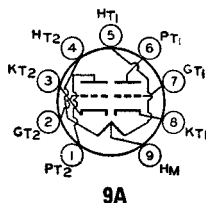

9A

strings. Tube is also used in other applications including phase-inverter circuits and multivibrator circuits. Outline 6E, **Outlines** section. This tube requires miniature nine-contact socket and may be mounted in any position. Each triode unit is independent of the other except for the common heater.

Heater Arrangement:	Series	Parallel	
Heater Voltage (ac/dc)	12.6	6.3	volts
Heater Current	0.3	0.6	ampere
Heater Warm-up Time (Average)	—	11	seconds
Peak Heater-Cathode Voltage:			
Heater negative with respect to cathode		200 max	volts
Heater positive with respect to cathode		200*max	volts
Direct Interelectrode Capacitances (Approx.):	Unit No.1	Unit No.2	
Grid to Plate	2.6	2.6	pF
Grid to Cathode and Heater	3.2	3.2	pF
Plate to Cathode and Heater	0.5	0.4	pF
Plate of Unit No.1 to Plate of Unit No.2		0.8	pF

\* The dc component must not exceed 100 volts.

**Class A<sub>1</sub> Amplifier (Each Unit)**

**MAXIMUM RATINGS (Design-Center Values):**

Plate Voltage .....	300 max	volts
Grid Voltage:		
Negative-bias value .....	-50 max	volts
Positive-bias value .....	0 max	volts
Cathode Current .....	20 max	mA
Plate Dissipation:		
Each Plate .....	3.5 max	watts
Both plates (Both units operating) .....	7 max	watts

**CHARACTERISTICS:**

Plate Voltage .....	250	volts
Grid Voltage .....	-10.5	volts
Amplification Factor .....	16.5	
Plate Resistance (Approx.) .....	5300	ohms
Transconductance .....	3100	μmhos
Grid Voltage (Approx.) for plate current of 50 μA .....	-23	volts
Plate Current .....	11.5	mA
Plate Current for grid voltage of -14 volts .....	4	mA

**MAXIMUM CIRCUIT VALUES:**

Grid-Circuit Resistance:		
For fixed-bias operation .....	0.25 max	megohm
For cathode-bias operation .....	1.0 max	megohm

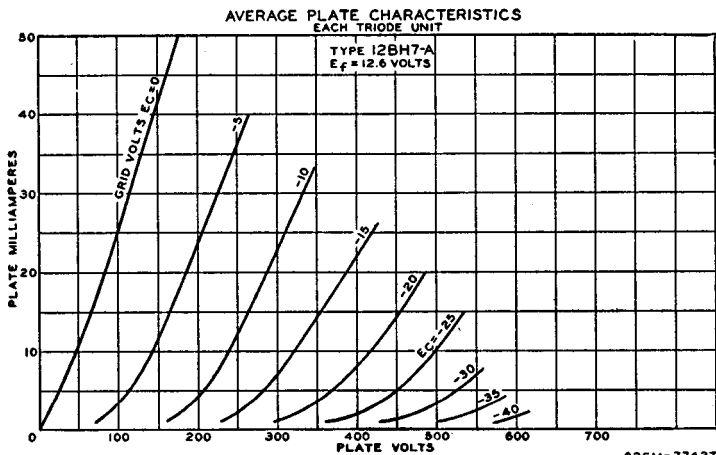

**Oscillator (Each Unit)**

For operation in a 525-line, 30-frame system

**MAXIMUM RATINGS (Design-Center Values):**

DC Plate Voltage .....	450 max	Vertical Deflection Oscillator	450 max	Horizontal Deflection Oscillator	volts
Peak Negative-Pulse Grid Voltage .....	-400 max		-600 max		volts
Peak Cathode Current .....	70 max		300 max		mA
Average Cathode Current .....	20 max		20 max		mA
Plate Dissipation:					
Each Plate .....	3.5 max		3.5 max		watts
Both Plates (Both units operating) .....	7 max		7 max		watts

**MAXIMUM CIRCUIT VALUES:**

Grid-Circuit Resistance .....	2.2 max	2.2 max megohms
-------------------------------	---------	-----------------

### Vertical Deflection Amplifier (Each Unit)

For operation in a 525-line, 30-frame system

#### MAXIMUM RATINGS (Design-Center Values):

DC Plate Voltage .....	450 max	volts
Peak Positive-Pulse Plate Voltage# (Absolute maximum) .....	1500*max	volts
Peak Negative-Pulse Grid Voltage .....	-250 max	volts
Peak Cathode Current .....	70 max	mA
Average Cathode Current .....	20 max	mA
Plate Dissipation:		
Each Plate .....	3.5 max	watts
Both Plates (Both units operating) .....	7 max	watts

#### MAXIMUM CIRCUIT VALUE:

Grid-Circuit Resistance:		
For cathode-bias operation .....	2.2 max	megohms

# The duration of the voltage pulse must not exceed 15 per cent of one vertical scanning cycle. In a 525-line, 30-frame system, 15 per cent of one vertical scanning cycle is 2.5 milliseconds.

\* Under no circumstances should this absolute value be exceeded.

### HALF-WAVE VACUUM RECTIFIER

# 12BT3

Duodecar type used as damper tube in horizontal-deflection circuits of television receivers. Outline 8C, **Outlines** section. Tube requires duodecar twelve-contact socket and may be mounted in any position. Heater volts (ac/dc), 12.6; amperes, 0.45.

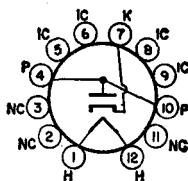

12BL

#### Damper Service

For operation in a 525-line, 30-frame system

#### MAXIMUM RATINGS (Design-Maximum Values):

Peak Inverse Plate Voltage# .....	3300 max	volts
Peak Plate Current .....	1000 max	mA
DC Plate Current .....	165 max	mA
Plate Dissipation .....	5.3 max	watts
Peak Heater-Cathode Voltage:		
Heater negative with respect to cathode .....	3300*max	volts
Heater positive with respect to cathode .....	300*max	volts

#### CHARACTERISTICS, Instantaneous Value:

Tube Voltage Drop for plate current of 250 mA max .....	21	volts
---	----	-------

# The duration of the voltage pulse must not exceed 15 per cent of one horizontal scanning cycle. In a 525-line, 30-frame system, 15 per cent of one horizontal scanning cycle is 10 microseconds.

• The dc component must not exceed 600 volts.

▪ The dc component must not exceed 100 volts.

### SHARP-CUTOFF PENTODE

# 12BY7A

Miniature type used as video amplifier in television receivers. This type has a controlled heater warm-up time for use in series-connected heater strings. Outline 6E, **Outlines** section. Tubes require miniature nine-contact socket and may be mounted in any position.

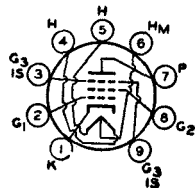

9BF

Heater Arrangement:	Series	Parallel	
Heater Voltage (ac/dc) .....	12.6	6.3	volts
Heater Current .....	0.3	0.6	ampere
Heater Warm-up Time (Average) .....	—	11	seconds

### Peak Heater-Cathode Voltage:

Heater negative with respect to cathode .....	200 max	volts
Heater positive with respect to cathode .....	200° max	volts

### Direct Interelectrode Capacitances:

Grid No.1 to Plate .....	0.063	pF
Grid No.1 to Cathode, Heater, Grid No.2, Grid No.3, and Internal Shield .....	10.2	pF
Plate to Cathode, Heater, Grid No.2, and Internal Shield .....	3.5	pF

\* The dc component must not exceed 100 volts.

### MAXIMUM RATINGS (Design-Maximum Values):

Plate Supply Voltage .....	330 max	volts
Grid-No.3 (Suppressor-Grid) Voltage, Positive value .....	0 max	volts
Grid-No.2 (Screen-Grid) Voltage .....	190 max	volts
Grid-No.1 (Control-Grid) Voltage .....		
Negative-bias value .....	-55 max	volts
Positive-bias value .....	0 max	volts

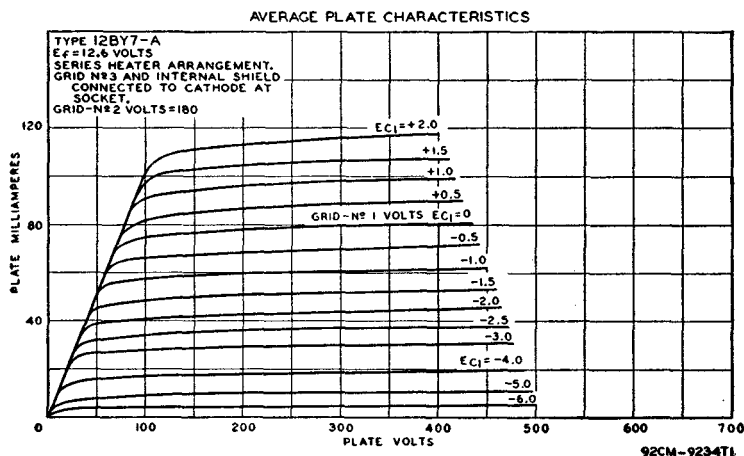

Grid-No.2 Input .....	1.2 max	watts
Plate Dissipation .....	6.5 max	watts

### CHARACTERISTICS:

Plate Supply Voltage .....	250	volts
Grid No.3 .....	Connected to cathode at socket	
Grid-No.2 Supply Voltage .....	180	volts
Cathode-Bias Resistor .....	100	ohms
Plate Resistance (Approx.) .....	93000	ohms
Transconductance .....	11000	$\mu\text{mhos}$
Plate Current .....	26	mA
Grid-No.2 Current .....	5.75	mA
Grid-No.1 Voltage (Approx.) for plate current of 20 $\mu\text{A}$ .....	-11.6	volts

### MAXIMUM CIRCUIT VALUES:

Grid-No.1-Circuit Resistance:		
For fixed-bias operation .....	0.25 max	megohm
For cathode-bias operation .....	1 max	megohm

## HIGH-MU TWIN TRIODE

# 12BZ7

Miniature type used in sync-separator and sync-amplifier circuits of television receivers. This tube is also used in clipping circuits and in general-purpose audio amplifier applications.

Outline 6E, **Outlines** section. Tube requires miniature nine-contact socket and may be mounted in any position. Heater volts (ac/dc), 12.6 (series), 6.3 (parallel); amperes, 0.3 (series), 0.6 (parallel); peak heater-cathode volts, 180.

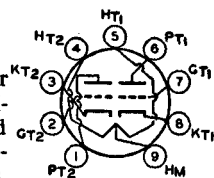

9A

### Class A<sub>1</sub> Amplifier (Each Unit)

#### MAXIMUM RATINGS (Design-Center Values):

Plate Voltage .....	300 max	volts
Grid Voltage:		
Negative-bias value .....	-50 max	volts
Positive-bias value .....	0 max	volts
Plate Dissipation .....	1.5 max	watts

#### CHARACTERISTICS:

Plate Voltage .....	250	volts
Grid Voltage .....	-2	volts
Amplification Factor .....	100	
Plate Resistance (Approx.) .....	31800	ohms
Transconductance .....	3200	μmhos
Plate Current .....	2.5	mA

#### MAXIMUM CIRCUIT VALUE:

Grid-Circuit Resistance:		
For contact-potential-bias operation .....	5 max	megohms

## 12C5

Refer to type 12CU5/12C5.

## 12CU6

Refer to type 12BQ6GTB/12CU6.

## HALF-WAVE VACUUM RECTIFIER

# 12D4

Glass octal type used as damper diode in horizontal-deflection circuits of television receivers employing series-connected heater strings. Outline 13D, **Outlines** section. Tube requires octal socket and may be mounted in any

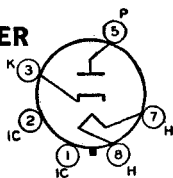

4CG

position. Socket terminals 1, 2, 4, and 6 should not be used as tie points. This type may be supplied with pin 1 omitted. It is especially important that this tube, like other power-handling tubes, be adequately ventilated. Heater volts (ac/dc), 12.6; amperes, 0.6; warm-up time (average), 11 seconds.

### Damper Service

For operation in a 525-line, 30-frame system

#### MAXIMUM RATINGS (Design-Maximum Values):

Peak Inverse Plate Voltage# .....	4400 max	volts
Peak Plate Current .....	900 max	mA
DC Plate Current .....	155 max	mA
Plate Dissipation .....	5.5 max	watts
Peak Heater-Cathode Voltage:		
Heater negative with respect to cathode# .....	4400*max	volts
Heater positive with respect to cathode .....	300*max	volts



- # The duration of the voltage pulse must not exceed 15 per cent of one horizontal scanning cycle. In a 525-line, 30-frame system, 15 per cent of one horizontal scanning cycle is 10 microseconds.
- ▲ The dc component must not exceed 900 volts.
- The dc component must not exceed 100 volts.

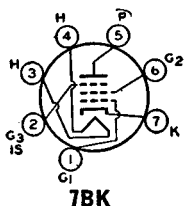

### REMOTE-CUTOFF PENTODE

Miniature type used as rf and if amplifier in low B+ voltage automobile radio receivers operating directly from 12-volt storage-battery systems. Outline 5C, **Outlines** section. Tube requires miniature seven-contact socket and may be mounted in any position.

## 12DZ6

Heater-Voltage Range (ac/dc)*	10.0 to 15.9	volts
Heater Current (Approx.) at 12.6 volts	0.19	ampere
<b>Peak Heater-Cathode Voltage:</b>		
Heater negative with respect to cathode	16 max	volts
Heater positive with respect to cathode	16 max	volts
<b>Direct Interelectrode Capacitances:</b>		
Grid No.1 to Plate	0.05 max	pF
Grid No.1 to Cathode, Heater, Grid No.2, Grid No.3, and Internal Shield	9.5	pF
Plate to Cathode, Heater, Grid No.2, Grid No.3, and Internal Shield	4	pF

\* For longest life, it is recommended that the heater be operated within the voltage range of 11 to 14 volts.

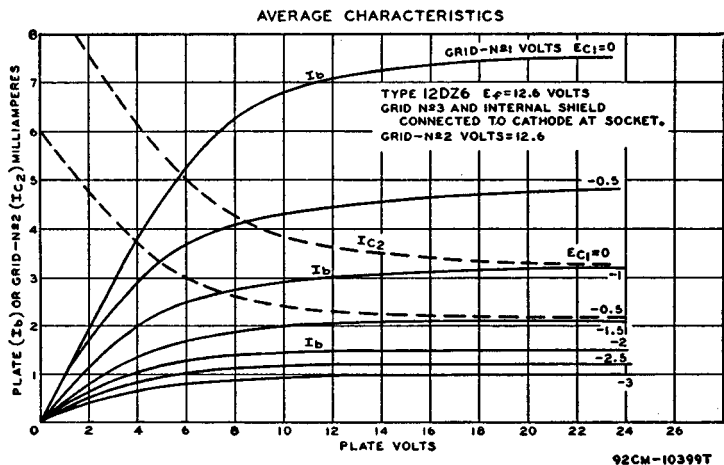

**MAXIMUM RATINGS (Design-Maximum Values):**

Plate Voltage	16 max	volts
Grid-No.2 (Screen-Grid) Voltage	16 max	volts
Grid-No.1 (Control-Grid) Voltage, Positive-bias value	0 max	volts

**CHARACTERISTICS WITH 12.6 VOLTS ON HEATER:**

Plate Voltage	12.6	volts
Grid No.3	Connected to cathode at socket	volts
Grid-No.2 Voltage	12.6	volts
Grid-No.1 Supply Voltage	0	volt
Grid-No.1 Resistor (Bypassed)	10	megohm

Grid-No.3 Resistor (Bypassed) .....	10	megohms
Plate Resistance (Approx.) .....	25000	ohms
Transconductance .....	3800	$\mu$ mhos
Grids No.1 and No.3 Supply Voltage (Approx.) for transconductance, grid No.1 to plate, of 10 $\mu$ mhos .....	-10	volts
Plate Current .....	4.5	mA
Grid-No.2 Current .....	2.2	mA

**MAXIMUM CIRCUIT VALUES:**

Grid-No.1-Circuit Resistance .....	10 max megohms
Grid-No.3-Circuit Resistance .....	10 max megohms

**HIGH-MU  
TWIN DOUBLE-PLATE TRIODE**

**12FQ8**

Miniature type used in frequency-divider and complex-wave-generator circuits of electronic musical instruments. Outline 6B, **Outlines** section. Tube requires miniature nine-contact socket and may be mounted in any

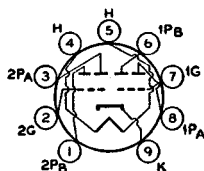

**9KT**

position. Heater volts (ac/dc), 12.6; amperes, 0.15; peak heater-cathode volts, 200 (the dc component must not exceed 100 volts when the heater is positive with respect to the cathode).

**Class A<sub>1</sub> Amplifier (Each Unit)**

**CHARACTERISTICS:**

Plate Voltage .....	250	volts
Grid Voltage .....	-1.5	volts
Amplification Factor .....	95	
Plate Resistance (Approx.) .....	76000	ohms
Transconductance .....	1250	$\mu$ mhos
Plate Current .....	1.5	mA

- Using either plate A or plate B, with plate not in use connected to ground.

**Frequency-Divider and Complex-Wave Generator (Each Unit)**

**MAXIMUM RATINGS (Design-Maximum Values):**

Plate A Voltage .....	330 max	volts
Plate B Voltage .....	330 max	volts
Grid Voltage, Positive-bias value .....	0 max	volts
Plate A Dissipation .....	0.5 max	watt
Plate B Dissipation .....	0.5 max	watt

**DIODE—MEDIUM-MU TRIODE—  
REMOTE-CUTOFF PENTODE**

**12FR8**

Miniature type used as if amplifier, audio amplifier, and second detector in receivers operating directly from 12-volt battery. Outline 6K, **Outlines** section. Tube requires miniature nine-contact socket and may be operated

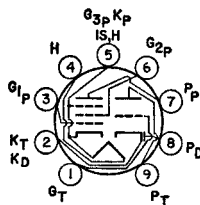

**9KU**

in any position. Heater voltage (ac/dc), 12.6; amperes, 0.32; peak heater-cathode voltage, 16.

<b>MAXIMUM RATINGS (Design-Center Values):</b>	Diode Unit	Triode Unit	Pentode Unit	
Plate Voltage .....	—	16 max	16 max	volts
Grid-No.2 (Screen-Grid) Voltage .....	—	—	16 max	volts
Grid-No.2 Supply Voltage .....	—	—	16 max	volts
Plate Current .....	5	—	—	mA

**CHARACTERISTICS:**

Plate Voltage .....	10	12.6	12.6	volts
---------------------	----	------	------	-------

Grid-No.2 Voltage	—	—	12.6	volts
Grid-No.1 (Control-Grid) Voltage, developed across a 2.2-megohm resistor	—	-0.6*	-0.8	volt
Transconductance	—	1200	2700	$\mu$ mhos
Plate Resistance (Approx.)	—	—	0.4	megohm
Amplification Factor	—	10	—	—
Plate Current	2	1	1.9	mA
Grid No.2 Current	—	—	0.7	mA
Grid-No.1 Voltage for transconductance of 30 $\mu$ mhos	—	—	-2.8	volts
Grid-No.1 Voltage for plate current of 10 $\mu$ A	—	-3.5	—	volts

**MAXIMUM CIRCUIT VALUES:**

Grid-No.1-Circuit Resistance	—	10 max	10 max	megohms
------------------------------	---	--------	--------	---------

\* Developed across a 2.2-megohm grid-No.1 resistor.

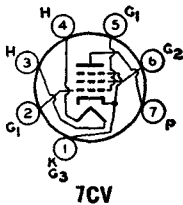

**POWER PENTODE**

Miniature type used in output stages of audio amplifiers employing series-connected heater strings. Outline 5D, **Outlines** section. Type 60FX5 is identical with type 12FX5 except for the heater ratings, as shown below.

**12FX5**

Related type:  
60FX5

	12FX5	60FX5	
Heater Voltage (ac/dc)	12.6	60	volts
Heater Current	0.45	0.1	ampere
Heater Warm-up Time (Average)	11	—	seconds
Peak Heater-Cathode Voltage:			
Heater negative with respect to cathode	200 max	200 max	volts
Heater positive with respect to cathode	200*max	200*max	volts
Direct Interelectrode Capacitances (Approx.):			
Grid No.1 to Plate		0.65	pF
Grid No.1 to Cathode, Heater, Grid No.2, and Grid No.3		17	pF
Plate to Cathode, Heater, Grid No.2, and Grid No.3		9	pF

\* The dc component must not exceed 100 volts.

**Class A<sub>1</sub> Amplifier**

**MAXIMUM RATINGS (Design-Maximum Values):**

Plate Voltage	150 max	volts
Grid-No.2 (Screen-Grid) Voltage	130 max	volts
Plate Dissipation	5.5 max	watts
Grid-No.2 Input	2 max	watts
Bulb Temperature (At hottest point)	225 max	°C

**TYPICAL OPERATION:**

Plate Supply Voltage	110	volts
Grid-No.2 Supply Voltage	115	volts
Cathode-Bias Resistor	62	ohms
Peak AF Grid-No.1 Voltage	3	volts
Zero-Signal Plate Current	36	mA
Maximum-Signal Plate Current	35	mA
Zero-Signal Grid No.2 Current	10	mA
Maximum-Signal Grid No.2 Current	12	mA
Plate Resistance	17500	ohms
Transconductance	13500	$\mu$ mhos
Load Resistance	3000	ohms
Total Harmonic Distortion	8	per cent
Maximum-Signal Power Output	1.3	watts

**MAXIMUM CIRCUIT VALUES:**

Grid-No.1-Circuit Resistance:

For fixed-bias operation	0.1 max	megohm
For cathode-bias operation	0.5 max	megohm

**MEDIUM-MU TRIODE—  
PENTAGRID CONVERTER**

**12FX8A**

Miniature type used as combined rf amplifier and frequency converter in low B+ voltage automobile radio receivers operating directly from 12-volt storage-battery systems. Outline 6D, **Outlines** section. Tube requires miniature

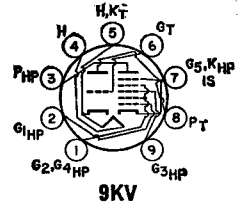

nine-contact socket and may be operated in any position. Heater-voltage range (dc), 10 to 15.9; amperes at 12.6 volts, 0.27; peak heater-cathode volts, 16.

**Heptode Unit as Converter**

**MAXIMUM RATINGS (Design-Center Values):**

Plate Voltage .....	16 max	volts
Grid-No.3 (Control-Grid) Voltage:		
Negative-bias value .....	-16 max	volts
Positive-bias value .....	0 max	volts
Grids-No.2 and No.4 (Screen-Grid) Voltage .....	16 max	volts

**TYPICAL OPERATION AND CHARACTERISTICS WITH  
12.6 VOLTS ON HEATER:\***

Plate Voltage .....	12.6	volts
Grid-No.3 Voltage* .....	-0.5	volt
Grids-No.2 and No.4 Voltage .....	12.6	volts
RMS Grid-No.1 (Oscillator-Grid) Voltage .....	1.6	volts
Grid-No.1 Resistor .....	33000	ohms
Plate Resistance (Approx.) .....	0.5	megohm
Conversion Transconductance .....	300	μmhos
Grid-No.3 Voltage (Approx.):		
For conversion transconductance of 10 μmhos .....	-3	volts
For conversion transconductance of 1 μmho .....	-8	volts
Plate Current .....	290	μA
Grids-No.2 and No.4 Current .....	1.25	mA

**OSCILLATOR CHARACTERISTICS (Not Oscillating):\***

Plate and Grids-No.2 and No.4 Voltage .....	12.6	volts
Grids-No.3 Voltage .....	0	volts
Grid-No.1 Voltage .....	0	volts
Amplification Factor (between grid No.1 and grids No.2 and No.4 connected to plate) .....	9	
Transconductance (between grid No.1 and grids No.2 and No.4 connected to plate) .....	3600	μmhos
Cathode Current .....	4.4	mA
Grid-No.1 Voltage (Approx.) for plate current of 10 μA .....	-4.5	volts

**MAXIMUM CIRCUIT VALUES:**

Grid-No.3-Circuit Resistance .....	10 max	megohms
------------------------------------	--------	---------

- \* With self-excitation.
- Developed across a 2.2-megohm grid-No.3 resistor.
- \* With grids No.2 and No.4 connected to plate and with 12.6 volts on heater.

**Triode Unit as Class A<sub>1</sub> Amplifier**

**MAXIMUM RATINGS (Design-Center Values):**

Plate Voltage .....	16 max	volts
---------------------	--------	-------

**CHARACTERISTICS WITH 12.6 VOLTS ON HEATER:**

Plate Voltage .....	12.6	volts
Grid Voltage□ .....	-0.8	volt
Amplification Factor .....	10	
Plate Resistance (Approx.) .....	7150	ohms
Transconductance .....	1400	μmhos
Plate Current .....	1.3	mA
Grid Voltage (Approx.) for plate current of 10 μA .....	-3.2	volts

□ Developed across a 2.2-megohm grid resistor.

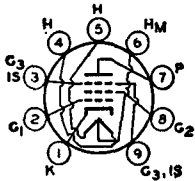

**SHARP-CUTOFF PENTODE**

Miniature type with frame grid used as video amplifier tube in television receivers employing series-connected heater strings. Outline 6E, **Outlines** section. Tube requires miniature nine-contact socket and may be mounted

**12GN7**  
**12GN7A**

in any position. Type 12GN7A is identical with type 12GN7 except for a higher plate dissipation. Heater volts, 6.3 (parallel), 12.6 (series); amperes, 0.6 (parallel), 0.3 (series); warm-up time (average), 11 seconds, peak heater-cathode volts, 200 (the dc component must not exceed 100 volts when the heater is positive with respect to the cathode).

**Class A<sub>1</sub> Amplifier**

**MAXIMUM RATINGS (Design-Maximum Values):**

Plate Voltage	400 max	volts
Grid-No.2 (Screen-Grid) Supply Voltage	330 max	volts
Grid-No.2 Voltage	See curve page 80	
Grid-No.1 (Control-Grid) Voltage, Positive-bias value	0 max	volts
Plate Dissipation (12GN7)	7.5 max	watts
Plate Dissipation (12GN7A)	11.5 max	watts
Grid-No.2 Input:		
For grid-No.2 voltages up to 165 volts	1.5 max	watts
For grid-No.2 voltages between 165 and 330 volts	See curve page 80	

**CHARACTERISTICS:**

Plate Supply Voltage	50	250	volts
Grid-No.2 Supply Voltage	125	150	volts
Grid-No.1 Voltage	0	0	volts
Cathode-Bias Resistor	—	56	ohms
Plate Resistance (Approx.)	—	0.05	megohm
Transconductance	—	36000	μmhos
Plate Current	70*	28	mA
Grid-No.2 Current	24*	6.5	mA
Grid-No.1 Voltage (Approx.) for plate current of 100 μA	—	-5.7	volts

**MAXIMUM CIRCUIT VALUES:**

Grid-No.1-Circuit Resistance	0.25 max	megohm
------------------------------	----------	--------

\* This value can be measured by a method involving a recurrent waveform such that the maximum ratings of the tube will not be exceeded.

Refer to type 12GW6/12DQ6B.

**12GW6**

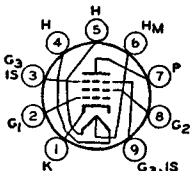

**SHARP-CUTOFF PENTODE**

Duodecar type with frame grid used as video amplifier in color television receivers. Outline 10C, **Outlines** section. Tube requires nine-contact duodecar socket and may be mounted in any position.

**12HG7**

Heater Arrangement:	Series	Parallel	
Heater Voltage (ac/dc)	12.6	6.3	volts
Heater Current	0.26	0.52	ampere
Peak Heater-Cathode Voltage:			
Heater negative with respect to cathode		200 max	volts
Heater positive with respect to cathode		200*max	volts

\* The dc component must not exceed 100 volts.

Direct Interelectrode Capacitances:

Grid No.1 to Plate .....	0.15 max	pF
Grid No.1 to Cathode, Heater, Grid No.2, Grid No.3, and Internal Shield .....	14 max	pF
Plate to Cathode, Heater, Grid No.2, Grid No.3, and Internal Shield .....	4.4 max	pF

**MAXIMUM RATINGS** (Design-Maximum Values):

Plate Voltage .....	400 max	volts
Grid-No.2 (Screen-Grid) Supply Voltage .....	330 max	volts
Grid-No.2 Voltage .....	See curve page 80	
Grid-No.1 (Control-Grid) Voltage, Positive-bias value .....	0 max	volts
Plate Dissipation .....	10 max	watts
Grid-No.2 Input:		
For Grid-No.2 voltages up to 165 volts .....	1 max	watt
For Grid-No.2 voltages between 165 and 330 volts .....	See curve page 80	

**Class A<sub>1</sub> Amplifier**

**CHARACTERISTICS:**

Plate Supply Voltage .....	300	volts
Grid-No.3 (Suppressor-Grid) Voltage .....	Connected to cathode at socket	
Grid-No.2 Supply Voltage .....	135	volts
Grid-No.1 Voltage .....	Connected to negative end of cathode resistor	
Cathode Resistor .....	47	ohms
Plate Resistance (Approx.) .....	60000	ohms
Transconductance .....	32000	μmhos
Plate Current .....	31	mA
Grid-No.2 Current .....	4.8	mA
Grid-No.1 Voltage (Approx.) for plate current of 100 μA .....	-4.5	volts

**MAXIMUM CIRCUIT VALUES:**

Grid-No.1-Circuit Resistance:		
For fixed-bias operation .....	0.1 max	megohm
For cathode-bias operation .....	0.25 max	megohm

**AVERAGE CHARACTERISTICS**

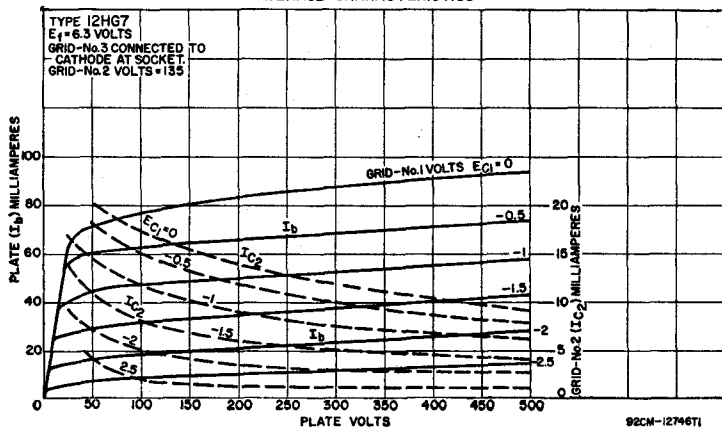

92CM-12746T1

**TWIN DIODE—  
HIGH-MU TRIODE**

Miniature type used as combined detector and af voltage amplifier in radio receivers. Outline 6B, Outlines section. Tube requires miniature nine-contact socket and may be operated in any position.

**14GT8**

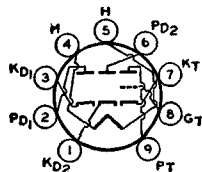

**9KR**

Heater Voltage (ac/dc) .....	14	volts
Heater Current .....	0.15	ampere
Peak Heater-Cathode Voltage:		
Heater negative with respect to cathode .....	200 max	volts
Heater positive with respect to cathode .....	200*max	volts
Amplification Factor° .....	72	
Plate Resistance (Approx.)° .....	72000	ohms
Transconductance° .....	1000	μmhos

\* The dc component must not exceed 100 volts.  
 ° For triode unit; plate volts, 250; grid volts, -3; plate mA, 0.7.

**Triode Unit as Class A<sub>1</sub> Amplifier**

**MAXIMUM RATINGS (Design-Maximum Values):**

Plate Voltage .....	330 max	volts
Grid Voltage, Positive-bias value .....	0 max	volts
Plate Dissipation .....	1.1 max	watts

**Diode Units (Each Unit)**

**MAXIMUM RATINGS (Design-Maximum Values):**

Plate Current .....	5 max	mA
---------------------	-------	----

**CHARACTERISTICS, Instantaneous Value:**

Tube Voltage Drop for plate current of 18 mA .....	5	volts
--	---	-------

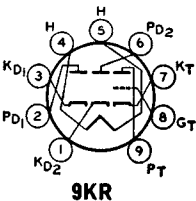
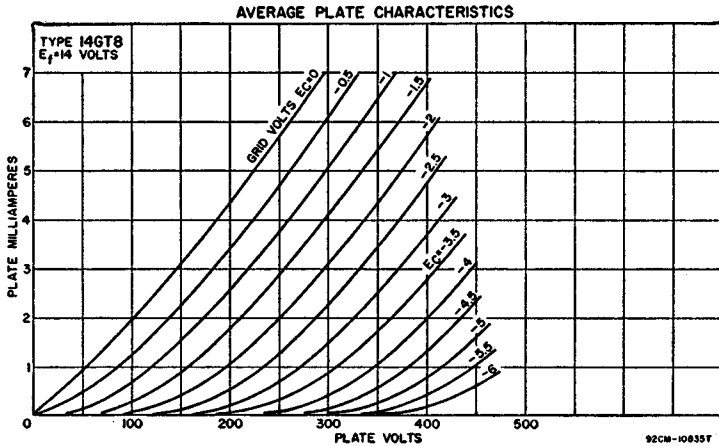

**TWIN DIODE—  
HIGH-MU TRIODE**

Miniature type used as combined FM detector and af voltage amplifier. Outline 6B, **Outlines** section. Tube requires miniature nine-contact socket and may be mounted in any position. Heater volts (ac/dc), 14; amperes,

**14JG8**

0.15; peak heater-cathode volts, 200 (the dc component must not exceed 100 volts when the heater is positive with respect to the cathode).

**Triode Unit as Class A<sub>1</sub> Amplifier**

**MAXIMUM RATINGS (Design-Maximum Values):**

Plate Voltage .....	330 max	volts
Grid-No.1 (Control-Grid) Voltages:		
Positive-bias Value .....	0 max	volts
Negative-bias Value .....	50 max	volts
Plate Dissipation .....	1.1 max	watts

**CHARACTERISTICS:**

Plate Voltage .....	250	volts
Grid Voltage .....	-2	volts
Amplification Factor .....	90	
Plate Resistance (Approx.) .....	41000	ohms
Transconductance .....	2200	μmhos
Plate Current .....	2	mA

**Diode Units**

**MAXIMUM RATINGS (Design-Maximum Values):**

Plate Current (Each Unit) .....	5 max	mA
---------------------------------	-------	----

**16AQ3**  
**16AQ3/**  
**XY88**

**DIODE**

Miniature types used as booster diodes in line-time-base circuits of transformerless television receivers. Outline, 7D, **Outlines** section. Tubes require miniature nine-contact socket and may

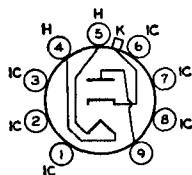

**9CB**

be mounted in any position. Heater volts (ac/dc), 16.4; amperes, 0.6; peak heater-cathode volts, 6600 (the pulse duration must not exceed 22 per cent of a cycle, or a maximum of 18 microseconds).

**MAXIMUM RATINGS (Design-Center Values):**

Supply Voltage at zero current .....	550 max	volts
Supply Voltage .....	250 max	volts
Peak Plate Current .....	550 max	mA
Average Plate Current .....	220 max	mA
Plate Dissipation .....	5 max	watts
Peak Negative-Pulse Plate Voltage*	-6000*max	volts

- \* Under no conditions should an absolute maximum value of 7500 volts be exceeded.
- The pulse duration must not exceed 22 per cent of a cycle, or a maximum of 18 microseconds.

**HIGH-MU TWIN TRIODE**

**17EW8**

Miniature type used in rf-amplifier and oscillator-mixer circuits in FM and AM radio receivers. Outline 6B, **Outlines** section. Tube requires miniature nine-contact socket and may be mounted in any position. Heater volts,

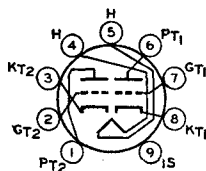

**9AJ**

17.5; amperes, 0.15; peak heater-cathode volts, 90.

**Class A<sub>1</sub> Amplifier (Each Unit)**

**MAXIMUM RATINGS (Design-Maximum Values):**

Plate Voltage .....	250 max	volts
Plate Dissipation .....	2.5 max	watts
Grid-Voltage, Negative-bias Value .....	-100 max	volts
Cathode Current .....	15 max	mA

**CHARACTERISTICS:**

Plate Voltage .....	100	170	200	volts
Amplification Factor .....	50	50	48	
Transconductance .....	4600	6200	5800	μmhos
Grid Voltage .....	-1.1*	-1.5	-2.1	volts
Plate Current .....	4.5	10	10	mA



**MAXIMUM CIRCUIT VALUES:**

Grid-Circuit Resistance ..... 1 max megohm

\* Should not be used if grid current is not permissible.

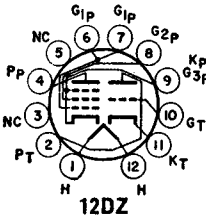

**MEDIUM-MU TRIODE—  
POWER PENTODE**

Duodecar type used as combined vertical-deflection-oscillator and vertical-deflection-amplifier tube in television receivers employing series-connected heater strings Outline 8B, **Outlines** section. Tube requires duodecar twelve-

**17JZ8**

contact socket and may be mounted in any position. Heater volts (ac/dc), 16.8; amperes, 0.45; warm-up time (average), 11 seconds; peak heater-cathode volts, 200 (the dc component must not exceed 100 volts when the heater is positive with respect to the cathode).

**Class A<sub>1</sub> Amplifier**

**CHARACTERISTICS:**

	Triode Unit	Pentode Unit	
Plate Voltage	150	45 120	volts
Grid-No.2 (Screen-Grid) Voltage	—	110 110	volts
Grid-No.1 (Control-Grid) Voltage	-5	0 -8	volts
Amplification Factor	21.5	— —	
Plate Resistance (Approx.)	11300	— 11700	ohms
Transconductance	1900	— 7100	μmhos
Plate Current	3.3	122* 46	mA
Grid-No.2 Current	—	17* 4	mA
Grid-No.1 Voltage (Approx.) for plate current of 100 μA	—	— -25	volts
Grid-No.1 Voltage (Approx.) for plate current of 10 μA	-10	— —	volts

\* This value may be measured by a method involving a recurrent waveform such that the maximum ratings of the tube will not be exceeded.

**Vertical-Deflection Oscillator and Amplifier**

For operation in a 525-line, 30-frame system

	Triode Unit Oscillator	Pentode Unit Amplifier	
<b>MAXIMUM RATINGS (Design-Maximum Values):</b>			
DC Plate Voltage	250 max	250 max	volts
Peak Positive-Pulse Plate Voltage#	—	2000 max	volts
Grid-No.2 Voltage	—	200 max	volts
Peak Negative-Pulse Grid-No.1 Voltage	-400 max	-150 max	volts
Peak Cathode Current	70 max	245 max	mA
Average Cathode Current	20 max	70 max	mA
Plate Dissipation†	1 max	7 max	watts
Grid-No.2 Input	—	1.8 max	watts

**MAXIMUM CIRCUIT VALUES:**

Grid-No.1-Circuit Resistance:		
For fixed-bias operation	1 max	1 max megohm
For cathode-bias operation	2.2 max	2.2 max megohms

# The duration of the voltage pulse must not exceed 15 per cent of one vertical scanning cycle. In a 525-line, 30-frame system, 15 per cent of one vertical scanning cycle is 2.5 milliseconds.

† An adequate bias resistor or other means is required to protect the tube in the absence of excitation.

**REMOTE-CUTOFF PENTODE****18FW6A**

Miniature type used as rf- and if-amplifier tube in ac/dc radio receivers. Outline 5C, **Outlines** section. Tube requires miniature seven-contact socket and may be mounted in any position. Heater volts (ac/dc), 18; amperes, 0.1;

warm-up time (average), 20 seconds; peak heater-cathode volts, 100.

**Class A<sub>1</sub> Amplifier****MAXIMUM RATINGS** (Design-Maximum Values):

Plate Voltage .....	150 max	volts
Grid-No.2 (Screen-Grid) Supply Voltage .....	150 max	volts
Grid-No.2 Voltage .....	See curve page 80	
Grid-No.1 (Control-Grid) Voltage, Positive-bias value .....	0 max	volts
Grid-No.2 Input:		
For grid-No.2 voltages up to 75 volts .....	0.6 max	watt
For grid-No.2 voltages between 75 and 150 volts .....	See curve page 80	
Plate Dissipation .....	2.5 max	watts

**CHARACTERISTICS:**

Plate Supply Voltage .....	100	volts
Grid No.3 .....	Connected to cathode at socket	
Grid-No.2 Supply Voltage .....	100	volts
Cathode-Bias Resistor .....	68	ohms
Plate Resistance (Approx.) .....	0.25	megohm
Transconductance .....	4400	$\mu$ mhos
Plate Current .....	11	mA
Grid-No.2 Current .....	4.4	mA
Grid-No.1 Voltage (Approx.) for transconductance of 25 $\mu$ mhos .....	-20	volts

**PENTAGRID CONVERTER****18FX6A**

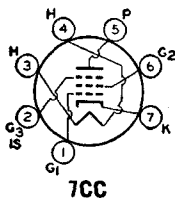
Miniature type used for converter applications in ac/dc radio receivers. Outline 5C, **Outlines** section. Tube requires miniature seven-contact socket and may be mounted in any position. Heater volts (ac/dc), 18; amperes, 0.1;

warm-up time (average), 20 seconds; peak heater-cathode volts, 100.

**Converter****MAXIMUM RATINGS** (Design-Maximum Values):

Plate Voltage .....	150 max	volts
Grids-No.2-and-No.4 (Screen-Grid) Supply Voltage .....	150 max	volts
Grids-No.2-and-No.4 Voltage .....	110 max	volts
Grids-No.2-and-No.4 Input .....	1.2 max	watts
Plate Dissipation .....	1 max	watt

**TYPICAL OPERATION** (Separate Excitation):\*

Plate Voltage .....	100	volts
Grids-No.2-and-No.4 (Screen-Grid) Voltage .....	100	volts
Grid-No.3 (Control-Grid) Voltage .....	-1.5	volts
Grid-No.1 (Oscillator-Grid) Resistor .....	20000	ohms
Plate Resistance (Approx.) .....	0.4	megohm
Conversion Transconductance .....	480	$\mu$ mhos
Grid-No.3 Voltage (Approx.) for conversion transconductance of 10 $\mu$ mhos .....	-21	volts
Plate Current .....	2.3	mA
Grids-No.2-and-No.4 Current .....	6.2	mA
Grid-No.1 Current .....	0.5	mA
Total Cathode Current .....	9	mA

**NOTE:** The transconductance between grid No.1 and grids No.2 and No.4 connected to plate (not oscillating) is approximately 7000  $\mu$ mhos under the following conditions: grids No.1 and No.3 at 0 volts; grids No.2 and No.4 and plate at 100 volts. Under the same conditions, the plate current is 24  $\mu$ A, and the amplification factor is 22.

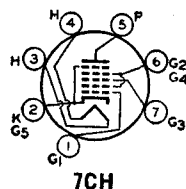
\* The characteristics shown with separate excitation correspond very closely with those obtained in a self-excited oscillator circuit operating with zero bias.

### TWIN DIODE— HIGH-MU TRIODE

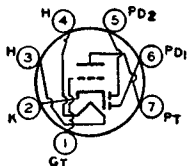

**7BT**

Miniature type used for combined detector, amplifier, and avc tube in compact ac/dc radio receivers. Out line 5C, **Outlines** section. Tube requires miniature seven-contact socket and may be mounted in any position.

**18FY6A**

Heater volts (ac/dc), 18; amperes, 0.1; warm-up time (average), 20 seconds; peak heater-cathode volts, 100.

#### Triode Unit as Class A<sub>1</sub> Amplifier

**MAXIMUM RATINGS** (Design-Maximum Values):

Plate Voltage	150 max	volts
Grid Voltage, Positive-bias value	0 max	volts
Plate Dissipation	0.5 max	watt

**CHARACTERISTICS:**

Plate Voltage	100	volts
Grid Voltage	-1	volt
Amplification Factor	100	
Plate Resistance (Approx.)	77000	ohms
Transconductance	1300	$\mu$ mhos
Plate Current	0.6	mA

#### Diode Units (Each Unit)

**MAXIMUM RATINGS** (Design-Maximum Values):

Plate Current	1 max	mA
---------------	-------	----

### SHARP-CUTOFF PENTODE

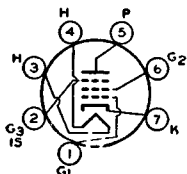

**7BK**

Miniature type used in the if, rf, and converter stages of ac/dc AM radio receivers. Outline 5C, **Outlines** section. Tube requires miniature seven-contact socket and may be operated in any position.

**18GD6A**

Heater Voltage (ac/dc)	18	volts
Heater Current	0.1	ampere
Warm-up Time (Average)	20	seconds

**Peak Heater-Cathode Voltage:**

Heater negative with respect to cathode	100 max	volts
Heater positive with respect to cathode	100 max	volts

**Direct Interelectrode Capacitances:<sup>o</sup>**

Grid-No.1 to Plate	0.0035	pF
Grid No.1 to Cathode, Heater, Grid No.2, Grid No.3, and Internal Shield	6.0	pF
Plate to Cathode, Heater, Grid No.2, Grid No.3 and Internal Shield	5.0	pF

\* Values are same without external shield, or with external shield connected to cathode.

#### Class A<sub>1</sub> Amplifier

**CHARACTERISTICS:**

Plate Supply Voltage	100	volts
Grid No.3 (Suppressor Grid)	Connected to cathode at socket	
Grid-No.2 (Screen-Grid) Voltage	100	volts

Cathode-Bias Resistor .....	150	ohms
Plate Resistance (Approx.) .....	0.5	megohm
Transconductance .....	4300	$\mu$ mhos
Plate Current .....	5	mA
Grid-No.2 Current .....	2	mA
Grid-No.1 Voltage (Approx.) for plate current of 10 $\mu$ A .....	-4.7	volts

**RF Amplifier and Converter**

**MAXIMUM RATINGS (Design-Maximum Values):**

Plate Voltage .....	150 max	volts
Grid-No.2 Supply Voltage .....	150 max	volts
Grid-No.2 Voltage .....	See curve page 80	
Plate Dissipation .....	2.5 max	watts
Grid-No.2 Input:		
For grid-No.2 voltages up to 75 volts .....	0.6 max	watt
For grid-No.2 voltages between 75 and 150 volts .....	See curve page 80	

**HALF-WAVE VACUUM RECTIFIER**

**19AU4**

Glass octal type used as damper diode in horizontal-deflection circuits of black-and-white television receivers employing series-connected heater strings. Outline 13G, **Outlines** section.

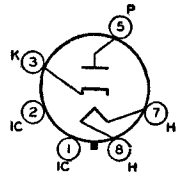

**4CG**

Tube requires octal socket and may be mounted in any position. This type may be supplied with pin 1 omitted. Socket terminals 1, 2, 4, and 6 should not be used as tie points. It is especially important that this tube, like other power-handling tubes, be adequately ventilated. Heater volts (ac/dc), 18.9; amperes, 0.6; warm-up time (average), 11 seconds.

**Damper Service**

For operation in a 525-line, 30-frame system

**MAXIMUM RATINGS (Design-Center Values):**

Peak Inverse Plate Voltage# .....	4500°max	volts
Peak Plate Current .....	1050 max	mA
DC Plate Current .....	175 max	mA
Plate Dissipation .....	6 max	watts
Peak Heater-Cathode Voltage:		
Heater negative with respect to cathode .....	4500°†max	volts
Heater positive with respect to cathode .....	300△max	volts

# The duration of the voltage pulse must not exceed 15 per cent of one horizontal scanning cycle. In a 525-line, 30-frame system, 15 per cent of one horizontal cycle is 10 microseconds.

° Under no circumstances should this absolute value be exceeded.

† The dc component must not exceed 900 volts.

△ The dc component must not exceed 100 volts.

**HIGH-MU TRIODE SHARP-CUTOFF PENTODE**

**19HV8**

Miniature type used as if-amplifier and af voltage-amplifier tube in radio receivers employing series-connected heater strings. Outline 6B, **Outlines** section. Tube requires miniature nine-contact socket and may be mounted

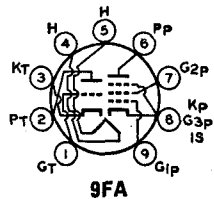

**9FA**

in any position. Heater volts (ac/dc), 18.9; amperes, 0.15; peak heater-cathode volts, 200 (the dc component must not exceed 100 volts when the heater is positive with respect to the cathode).

**Class A<sub>1</sub> Amplifier**

<b>MAXIMUM RATINGS</b> (Design-Maximum Values):	Triode Unit	Pentode Unit	
Plate Voltage .....	330 max	330 max	volts
Grid-No.2 (Screen-Grid) Supply Voltage .....	—	330 max	volts
Grid-No.2 Voltage .....	—	See curve page 80	volts
Grid-No.1 (Control-Grid) Voltage, Positive-bias value ..	0 max	0 max	volts
Plate Dissipation .....	0.55 max	3 max	watts
Grid-No.2 Input:			
For grid-No.2 voltages up to 165 volts .....	—	0.55 max	watt
For grid-No.2 voltages between 165 and 330 volts ..	—	See curve page 80	watts

<b>CHARACTERISTICS:</b>			
Plate Voltage .....	100	125	volts
Grid-No.2 Voltage .....	—	125	volts
Grid-No.1 Voltage .....	-1	-1	volt
Amplification Factor .....	70	—	
Plate Resistance (Approx.) .....	54000	200000	ohms
Transconductance .....	1300	6500	$\mu$ mhos
Plate Current .....	0.8	12	mA
Grid-No.2 Current .....	—	4	mA
Grid-No.1 Voltage (Approx.) for plate current of 50 $\mu$ A ..	-1.5	—	volts
Grid-No.1 Voltage (Approx.) for plate current of 20 $\mu$ A ..	—	-9	volts

<b>MAXIMUM CIRCUIT VALUES:</b>			
Grid-No.1-Circuit Resistance:			
For fixed-bias operation .....	0.5 max	0.25 max	megohm
For cathode-bias operation .....	1 max	1 max	megohm

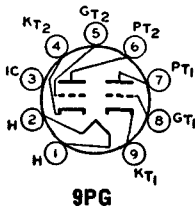

**HIGH-MU TWIN TRIODE**

Miniature type used in high-gain, resistance-coupled, low-level audio amplifiers operating at low-signal levels, such as preamplifiers for stereo phonographs. Outline 6B, **Outlines** section.

**20EZ7**

For typical operation as resistance-coupled amplifier, refer to **Resistance-Coupled Amplifier** section. Tube requires miniature nine-contact socket and may be operated in any position.

Heater Volts (ac/dc) .....	20	volts	
Heater Current .....	0.1	ampere	
Heater Warm-up Time (Average) .....	20	seconds	
<b>Peak Heater-Cathode Voltage:</b>			
Heater negative with respect to cathode .....	200 max	volts	
Heater positive with respect to cathode .....	200*max	volts	
<b>Direct Interelectrode Capacitances:*</b>			
Grid to Plate .....	1.5	1.5	pF
Grid to Cathode and Heater .....	1.6	1.6	pF
Plate to Cathode and Heater .....	0.2	0.3	pF

- \* The dc component must not exceed 100 volts.
- \* Without external shield.

**Class A<sub>1</sub> Amplifier (Each Unit)**

<b>MAXIMUM RATINGS</b> (Design-Maximum Values):		
Plate Voltage .....	330 max	volts
Grid Voltage:		
Negative-bias value .....	55 max	volts
Positive-bias value .....	0 max	volts
Plate Dissipation .....	1.2 max	watts

**CHARACTERISTICS:**

Plate Voltage .....	100	250	volts
Grid Voltage .....	-1	-2	volts
Amplification Factor .....	100	100	
Plate Resistance (Approx.) .....	80000	62500	ohms
Transconductance .....	1250	1600	$\mu$ mhos
Plate Current .....	0.5	1.2	mA

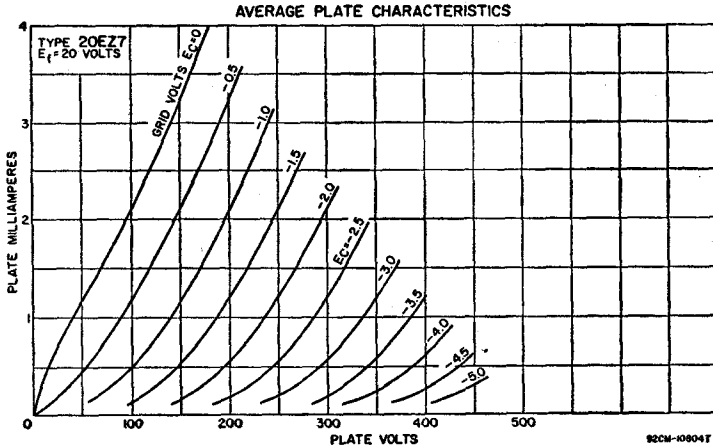

**HALF-WAVE VACUUM RECTIFIER**

**22BW3**

Duodecar type used as damper tube in horizontal-deflection circuits of television receivers. Outline 8D, **Outlines** section. Tube requires duodecar socket and may be mounted in any position. Heater volts (ac/dc), 22.4;

amperes, 0.45; average warm-up time, 11 seconds.

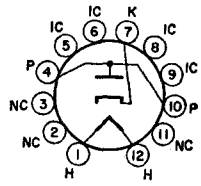

**12FX**

**Damper Service**

For operation in a 525-line, 30-frame system

**MAXIMUM RATINGS (Design-Maximum Values):**

Peak Inverse Plate Voltage*	5000 max	volts
Peak Plate Current	1100 max	mA
Average Plate Current	175 max	mA
Plate Dissipation	6.5 max	watts
Peak Heater-Cathode Voltage:		
Heater negative with respect to cathode	5000*max	volts
Heater positive with respect to cathode	300†max	volts

**CHARACTERISTICS, Instantaneous Value:**

Tube Voltage Drop for plate current of 350 mA	32	volts
---	----	-------

\* The dc component must not exceed 900 volts.

† The dc component must not exceed 100 volts.

\* The duration of the voltage pulse must not exceed 15 per cent of one scanning cycle. In a 525-line, 30-frame system, 15 per cent of one horizontal scanning cycle is 10 microseconds.

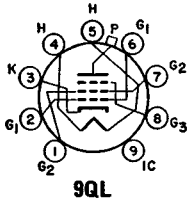

**BEAM POWER TUBE**

Novar type used as horizontal-deflection amplifier tube in low-B, black-and-white television receivers. Outline 18A, **Outlines** section. Tube requires novar nine-contact socket and may be mounted in any position.

**22JF6**  
Related type:  
22JF6

Heater Voltage (ac/dc) .....	22	volts
Heater Current .....	0.45	ampere
Heater Warm-up Time (Average) .....	11	seconds
Peak Heater-Cathode Voltage:		
Heater negative with respect to cathode .....	200 max	volts
Heater positive with respect to cathode .....	200*max	volts
Direct Interelectrode Capacitances:		
Grid No.1 to Plate .....	1.2	pF
Grid No.1 to Cathode, Heater, Grid No.2, and Grid No.3 .....	22	pF
Plate to Cathode, Heater, Grid No.2, and Grid No.3 .....	9	pF

\* The dc component must not exceed 100 volts.

**Class A<sub>1</sub> Amplifier**

**CHARACTERISTICS:**

Peak Positive-Pulse Plate Voltage** .....	6500	—	—	volts
Plate Voltage .....	—	50	130	volts
Grid No.3 (Suppressor Grid) .....	—	Connected to cathode at socket		
Grid-No.2 (Screen-Grid) Voltage .....	125	125	125	volts
Grid-No.1 (Control-Grid) Voltage .....	—	0	-20	volts
Plate Resistance (Approx.) .....	—	—	12000	ohms
Transconductance .....	—	—	10000	μmhos
Plate Current .....	—	525†	80	mA
Grid-No.2 Current .....	—	32†	2.5	mA
Grid-No.1 Voltage (Approx.) for plate current of 1 mA .....	-125	—	-40	volts
Triode Amplification Factor†† .....	—	—	4.1	

\*\* The duration of the voltage pulse must not exceed 15 per cent of one horizontal scanning cycle. In a 525-line, 30-frame system, 15 per cent of one horizontal scanning cycle is 10 microseconds.

† This value can be measured by a method involving a recurrent waveform such that the maximum ratings of the tube will not be exceeded.

†† Triode connection (grid No.2 tied to plate).

**Horizontal-Deflection Amplifier**

For operation in a 525-line, 30-frame system

**MAXIMUM RATINGS** (Design-Maximum Values):

DC Plate Supply Voltage .....	770 max	volts
Peak Positive-Pulse Plate Voltage** .....	6500 max	volts
Peak Negative-Pulse Plate Voltage .....	1500 max	volts
DC Grid-No.3 Voltage* .....	100 max	volts
DC Grid-No.2 Voltage .....	220 max	volts
Peak Negative-Pulse Grid-No.1 Voltage .....	330 max	volts
Peak Cathode Current .....	950 max	mA
Average Cathode Current .....	275 max	mA
Grid-No.2 Input .....	3.5 max	watts
Plate Dissipation** .....	17 max	watts
Bulb Temperature (at hottest point) .....	240 max	°C

**MAXIMUM CIRCUIT VALUES:**

For grid-resistor-bias operation .....	0.47 max	megohm
For plate-pulsed operation (horizontal-deflection circuits only) ..	10 max	megohms

• In a horizontal-deflection-amplifier service, a positive voltage (typical value, 50 volts) may be applied to grid No.3 to reduce "snivets" interference, which may occur in both vhf and uhf television receivers.

•• An adequate bias resistor or other means is required to protect the tube in the absence of excitation.

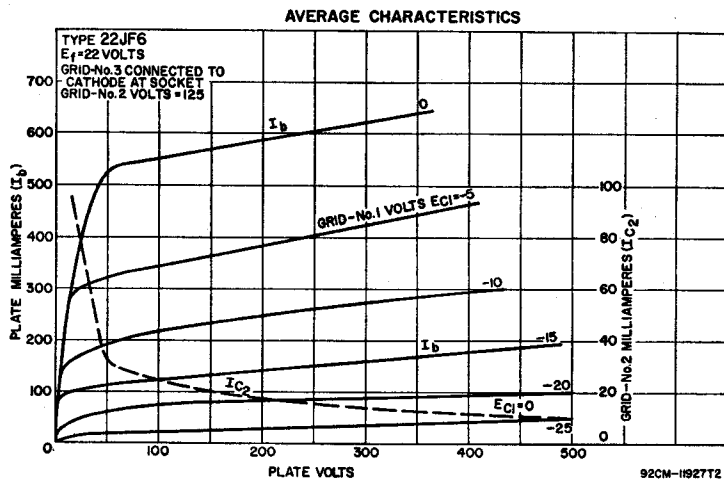
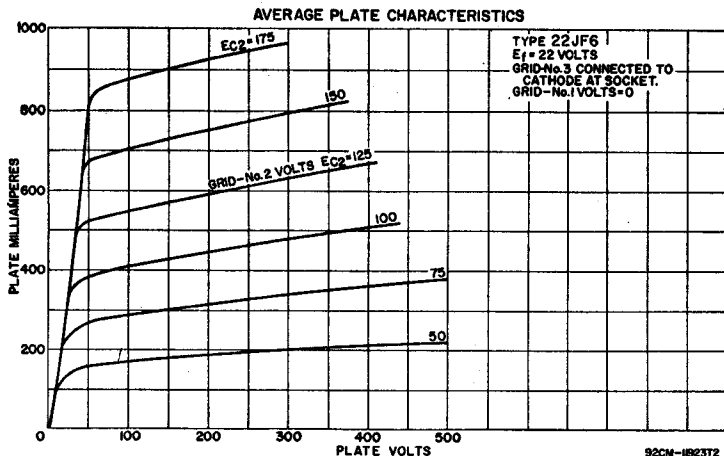

**BEAM POWER TUBE**

Novar type used as horizontal deflection amplifier in low-B+ black-and-white television receivers employing series-connected heater strings. Outline 18A, **Outlines** section. Tube requires novar nine-contact socket and may be mounted in any position.

**22JU6**

Heater Voltage (ac/dc)	.....
Heater Current	.....
Heater Warm-up Time (Average)	.....
Peak Heater-Cathode Voltage:	.....
Heater negative with respect to cathode	.....
Heater positive with respect to cathode	.....
Direct Interelectrode Capacitances:	.....
Grid No.1 to Plate	.....
Grid No.1 to Cathode, Heater, Grid No.2, and Grid No.3	.....
Plate to Cathode, Heater, Grid No.2, and Grid No.3	.....

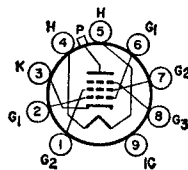

**9QL**

22	volts
0.45	ampere
11	seconds
200 max	volts
200*max	volts
1.2	pF
2.2	pF
9	pF



• The dc component must not exceed 100 volts.

**Class A<sub>1</sub> Amplifier**

CHARACTERISTICS:	Triode Connection*		Pentode Connection		
Plate Voltage	125	50	130		volts
Grid No.3 (Suppressor Grid)	Connected	to cathode	at socket		
Grid-No.2 (Screen-Grid) Voltage	—	125	125		volts
Grid-No.1 (Control-Grid) Voltage	—20	0	—20		volts
Amplification Factor	5	—	—		
Plate Resistance (Approx.)	—	—	18000		ohms
Transconductance	—	—	7000		μmhos
Plate Current	—	470*	45		mA
Grid-No.2 Current	—	28*	1.5		mA
Grid-No.1 Voltage (Approx.) for plate current of 1 mA	—	—	—32		volts

\* Grid No.2 connected to plate.

• This value can be measured by a method involving a recurrent waveform such that the maximum ratings of the tube will not be exceeded.

**Horizontal-Deflection Amplifier**

For operation in a 525-line, 30-frame system

**MAXIMUM RATINGS (Design-Maximum Values):**

DC Plate Supply Voltage	770 max	volts
Peak Positive-Pulse Plate Voltage#	6500 max	volts
Peak Negative-Pulse Plate Voltage	—1500 max	volts
DC Grid-No.3 Voltage <sup>▲</sup>	75 max	volts
DC Grid-No.2 Voltage	220 max	volts
DC Grid-No.1 Voltage	—55 max	volts
Peak Negative-Pulse Grid-No.1 Voltage	—330 max	volts
Peak Cathode Current	850 max	mA
Average Cathode Current	245 max	mA
Plate Dissipation†	17 max	watts
Grid-No.2 Input	3.5 max	watts
Bulb Temperature (At hottest point)	240 max	°C

**MAXIMUM CIRCUIT VALUE:**

Grid-No.1-Circuit Resistance:  
 For grid-No.1-resistor-bias operation ..... 2.2 max megohms

# The duration of the voltage pulse must not exceed 15 per cent of one horizontal scanning cycle. In a 525-line, 30-frame system, 15 per cent of one horizontal scanning cycle is 10 microseconds.

▲ In this service, a positive voltage may be applied to grid No.3 to minimize "snivets" interference; a typical value for this voltage is 30 volts.

† An adequate bias resistor or other means is required to protect the tube in the absence of excitation.

Refer to type 25BQ6GTB/25CU6.

**25CU6**

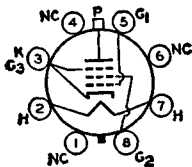

**5BT**

**BEAM POWER TUBE**

Glass octal type used as horizontal-deflection amplifier in television receivers employing series-connected heater strings. Outline 21B, Outlines section. Tube requires octal socket. Vertical tube mounting is preferred

**25DN6**

but horizontal operation is permissible if pins 1 and 3 are in vertical plane.

Heater Voltage (ac/dc)	25	volts
Heater Current	0.6	ampere
Heater Warm-up Time (Average)	11	seconds
Peak Heater-Cathode Voltage:		
Heater negative with respect to cathode	200 max	volts
Heater positive with respect to cathode	200*max	volts
Plate Resistance (Approx.)†	4000	ohms
Transconductance‡	9000	μmhos
Mu-Factor,† Grid No.2 to Grid No.1	4.35	

\* The dc component must not exceed 100 volts.

† For plate and grid-No.2 volts, 125; grid-No.1 volts, -18; plate mA, 70; grid-No.2 mA, 6.3.

### Horizontal-Deflection Amplifier

For operation in a 525-line, 30-frame system

#### MAXIMUM RATINGS (Design-Center Values):

DC Plate Voltage	700 max	volts
Peak Positive-Pulse Plate Voltage# (Absolute Maximum)	6600□max	volts
Peak Negative-Pulse Plate Voltage	-1500 max	volts
DC Grid-No.2 (Screen-Grid) Voltage	175 max	volts
Peak Negative-Pulse Grid-No.1 (Control-Grid) Voltage	-200 max	volts
Peak Cathode Current	700 max	mA
Average Cathode Current	200 max	mA
Grid-No.2 Input	3 max	watts
Plate Dissipation†	15 max	watts
Bulb Temperature (At hottest point)	225 max	°C

#### MAXIMUM CIRCUIT VALUE:

Grid-No.1-Circuit Resistance	0.47 max	megohm
------------------------------	----------	--------

# The duration of the voltage pulse must not exceed 15 per cent of one horizontal scanning cycle. In a 525-line, 30-frame system, 15 per cent of one horizontal scanning cycle is 10 microseconds.

□ Under no circumstances should this absolute value be exceeded.

† An adequate bias resistor or other means is required to protect the tube in the absence of excitation.

### BEAM POWER TUBE

Miniature type used in audio-output stage of ac/dc radio receivers employing series-connected heater strings. Outline 5D, **Outlines** section. Tube requires miniature seven-contact socket and may be mounted in any position.

## 25F5A

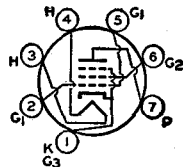

7CV

Heater Voltage (ac/dc)	25	volts
Heater Current	0.15	ampere
Heater Warm-up Time (Average)	17	seconds
Peak Heater-Cathode Voltage:		
Heater negative with respect to cathode	200 max	volts
Heater positive with respect to cathode	200*max	volts
Direct Interelectrode Capacitances (Approx.):		
Grid No.1 to Plate	0.44	pF
Grid No.1 to Cathode, Heater, Grid No.2, and Grid No.3	12	pF
Plate to Cathode, Heater, Grid No.2, and Grid No.3	8	pF

\* The dc component must not exceed 100 volts.

### Class A<sub>1</sub> Amplifier

#### MAXIMUM RATINGS (Design-Maximum Values):

Plate Voltage	150 max	volts
Grid-No.2 (Screen-Grid) Voltage	130 max	volts
Grid-No.1 (Control-Grid) Voltage, Positive-bias value	0 max	volts
Plate Dissipation	5.5 max	watts
Grid-No.2 Input	1.1 max	watts
Bulb Temperature (at hottest point)	220 max	°C

**TYPICAL OPERATION AND CHARACTERISTICS:**

Plate Voltage .....	110	volts
Grid-No.2 Voltage .....	110	volts
Grid-No.1 Voltage .....	-7.5	volts
Peak AF Grid-No.1 Voltage .....	-7.5	volts
Plate Resistance (Approx.) .....	13000	ohms
Transconductance .....	6400	$\mu$ mhos
Zero-Signal Plate Current .....	43	mA
Maximum-Signal Plate Current .....	45	mA
Zero-Signal Grid-No.2 Current .....	3.8	mA
Maximum-Signal Grid-No.2 Current .....	7.3	mA
Effective Load Resistance .....	2500	ohms
Total Harmonic Distortion .....	7	per cent
Maximum-Signal Power Output .....	1.5	watts

**MAXIMUM CIRCUIT VALUES:**

Grid-No.1-Circuit Resistance:

For fixed-bias operation .....	0.1 max megohm
For cathode-bias operation .....	0.5 max megohm

**Push-Pull Class AB<sub>1</sub> Amplifier**

**MAXIMUM RATINGS:** (Same as for class AB<sub>1</sub> amplifier)

**TYPICAL OPERATION** (Values are for two tubes):

Plate Voltage .....	110	volts
Grid-No.2 Voltage .....	110	volts
Grid-No.1 Voltage .....	-8	volts
Peak AF Grid-No.1-to-Grid-No.1 Voltage .....	14.4	volts
Zero-Signal Plate Current .....	82	mA
Maximum-Signal Plate Current .....	88	mA
Zero-Signal Grid-No.2 Current .....	7.2	mA
Maximum-Signal Grid-No.2 Current .....	12.5	mA
Effective Load Resistance (Plate-to-plate) .....	4500	ohms
Total Harmonic Distortion .....	2.6	per cent
Maximum-Signal Power Output .....	2.9	watts

**MAXIMUM CIRCUIT VALUES:**

Grid-No.1-Circuit Resistance:

For fixed-bias operation .....	0.1 max megohm
For cathode-bias operation .....	0.5 max megohm

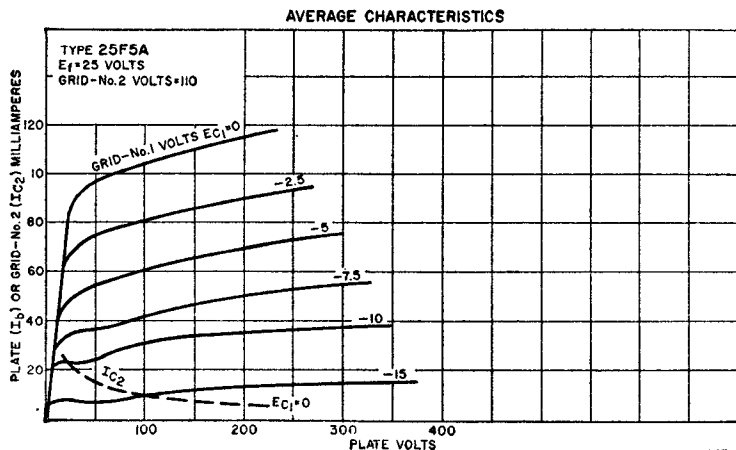

## POWER PENTODE

## 32ET5A

Miniature type used in audio output stage of compact ac/dc radio receivers. Outline 5D, **Outlines** section. Tube requires miniature seven-contact socket and may be mounted in any position.

Heater volts (ac/dc), 32; amperes, 0.1;

warm-up time (average), 20 seconds; peak heater-cathode volts, 200 (the dc component must not exceed 100 volts when the heater is positive with respect to the cathode).

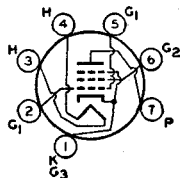

7CV

Class A<sub>1</sub> Amplifier

## MAXIMUM RATINGS (Design-Maximum Values):

Plate Voltage	150 max	volts
Grid-No.2 (Screen-Grid) Voltage	130 max	volts
Grid-No.2 Input	1.2 max	watts
Plate Dissipation	5.4 max	watts

## TYPICAL OPERATION AND CHARACTERISTICS:

Plate Voltage	110	volts
Grid-No.2 Voltage	110	volts
Grid-No.1 (Control-Grid) Voltage	-7.5	volts
Peak AF Grid-No.1 Voltage	7.5	volts
Zero-Signal Plate Current	30	mA
Zero-Signal Grid-No.2 Current	2.8	mA
Plate Resistance (Approx.)	21500	ohms
Transconductance	5500	μmhos
Load Resistance	2800	ohms
Total Harmonic Distortion	10	per cent
Maximum-Signal Power Output	1.2	watts

## MAXIMUM CIRCUIT VALUES:

## Grid-No.1-Circuit Resistance:

For fixed-bias operation	0.1 max	megohm
For cathode-bias operation	0.5 max	megohm

## DIODE—BEAM POWER TUBE

## 33GT7

Duodecax type used in a wide variety of applications in television receivers. The diode unit is used for damper service and the beam power unit for horizontal-deflection amplifier service. Outline 15A, **Outlines** section. Tube

requires duodecax twelve-contact socket and may be mounted in any position.

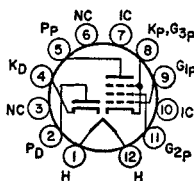

12FC

Heater Voltage (ac/dc)	33.6	volts
Heater Current	0.45	ampere
Heater Warm-up Time (Average)	11	seconds
Peak Heater-Cathode Voltage:		
Heater negative with respect to cathode	200 max	volts
Heater positive with respect to cathode	200*max	volts
Direct Interelectrode Capacitances (Approx.):		
Diode Unit:		
Plate to Cathode and Heater	5.5	pF
Cathode to Plate and Heater	8.5	pF
Heater to Cathode	3.2	pF
Beam Power Unit:		
Grid No.1 to Plate	0.2	pF
Grid No.1 to Cathode, Heater, Grid No.2, and Grid No.3	17	pF
Plate to Cathode, Heater, Grid No.2, and Grid No.3	7	pF

\* The dc component must not exceed 100 volts.

Beam Power Unit as Class A<sub>1</sub> Amplifier

CHARACTERISTICS:

Plate Voltage	3500	60	130	volts
Grid-No.2 (Screen-Grid) Voltage	130	130	130	volts
Grid-No.1 (Control-Grid) Voltage	—	0	-22.5	volts
Plate Resistance (Approx.)	—	—	10000	ohms
Transconductance	—	—	6500	μmhos
Grid-No.1 Voltage (Approx.) for plate current of 1 mA	-60	—	-40	volts
Plate Current	—	320	48	mA
Grid-No.2 Current	—	22	2.9	mA
Triode Amplification Factor†	—	—	4	

† Triode connection (grid No.2 tied to plate).

Beam Power Unit as Horizontal-Deflection Amplifier

For operation in a 525-line, 30-frame system

MAXIMUM RATINGS (Design-Maximum Ratings):

Plate Voltage	400 max	volts
Peak Positive-Pulse Plate Voltage††	3500 max	volts
Peak Negative-Pulse Plate Voltage	0 max	volts
Grid-No.2 Voltage	150 max	volts
DC Grid-No.1 DC Voltage, Negative-bias value	-55 max	volts
Peak Negative-Pulse Grid-No.1 Voltage	-330 max	volts
Average Cathode Current	140 max	mA
Peak Cathode Current	490 max	mA
Plate Dissipation*	9 max	watts
Grid-No.2 Input	2.5 max	watts

MAXIMUM CIRCUIT VALUES:

Grid-No.1-Circuit Resistance	1 max	megohm
------------------------------	-------	--------

\* An adequate bias resistor or other means is required to protect the tube in the absence of excitation.

Damper Service—Diode Unit

For operation in a 525-line, 30-frame system

MAXIMUM RATINGS (Design-Maximum Values):

Peak Inverse Plate Voltage††	2500 max	volts
Peak Plate Current	750 max	mA
DC Plate Current	125 max	mA
Plate Dissipation	3.5 max	watts
Peak Heater-Cathode Voltage:		
Heater negative with respect to cathode	2500□max	volts
Heater positive with respect to cathode	200□□max	volts
Bulb Temperature (at hottest point)	220 max	°C

CHARACTERISTICS, Instantaneous Value:

Tube Voltage Drop for plate current of 250 mA	21	volts
---	----	-------

†† The duration of the voltage pulse must not exceed 15 per cent of one horizontal scanning cycle. In a 525-line, 30-frame system, 15 per cent of one horizontal scanning cycle is 10 microseconds.

- The dc component must not exceed 400 volts.
- The dc component must not exceed 100 volts.

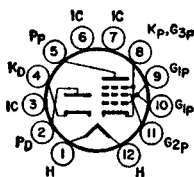

12FN

DIODE—BEAM POWER TUBE

Duodecar type used as combined damper diode and horizontal deflection amplifier in television receivers employing series-connected heater strings. Outline 15A, Outlines section. Tube requires duodecar twelve-contact socket and may be mounted in any position. Heater volts (ac/dc), 33.6; amperes, 0.45; warm-up time (average), 11 seconds.

**33GY7**

Heater volts (ac/dc), 33.6; amperes, 0.45; warm-up time (average), 11 seconds.

### Beam Power Unit as Class A<sub>1</sub> Amplifier

#### CHARACTERISTICS:

Plate Voltage	5000	60	130	volts
Grid-No.2 (Screen-Grid) Voltage	130	130	130	volts
Grid-No.1 (Control-Grid) Voltage	—	0	-22.5	volts
Triode Amplification Factor	—	—	4*	
Plate Resistance (Approx.)	—	—	10000	ohms
Transconductance	—	—	6500	μmhos
Plate Current	—	320*	48	mA
Grid-No.2 Current	—	22*	2.9	mA
Grid-No.1 Voltage (Approx.) for plate current of 1 mA	-80	—	-40	volts

\* Grid No.2 tied to plate.

† This value can be measured by a method involving a recurrent waveform such that the maximum ratings of the tube will not be exceeded.

### Beam Power Unit as Horizontal-Deflection Amplifier

For operation in a 525-line, 30-frame system

#### MAXIMUM RATINGS (Design-Maximum Values):

	Power Beam Unit	
DC Plate Supply Voltage	400 max	volts
Peak Positive-Pulse Plate Voltage#	5000 max	volts
Peak Negative-Pulse Plate Voltage	0 max	volts
DC Grid-No.2 Voltage	150 max	volts
DC Grid-No.1 Voltage	-55 max	volts
Peak Negative-Pulse Grid-No.1 Voltage	-330 max	volts
Peak Cathode Current	540 max	mA
Average Cathode Current	155 max	mA
Plate Dissipation†	9 max	watts
Grid-No.2 Input	3 max	watts
Peak Heater-Cathode Voltage:		
Heater negative with respect to cathode	200 max	volts
Heater positive with respect to cathode	200* max	volts

#### MAXIMUM CIRCUIT VALUE:

Grid-No.1-Circuit Resistance	1 max	megohm
------------------------------	-------	--------

# The duration of the voltage pulse must not exceed 15 per cent of one horizontal scanning cycle. In a 525-line, 30-frame system, 15 per cent of one horizontal scanning cycle is 10 microseconds.

† An adequate bias resistor or other means is required to protect the tube in the absence of excitation.

\* The dc component must not exceed 100 volts.

### Damper Service (Diode Unit)

For operation in a 525-line, 30-frame system

#### MAXIMUM RATINGS (Design-Maximum Values):

	Diode Unit	
Peak Inverse Plate Voltage#	4200 max	volts
Peak Plate Current	810 max	mA
DC Plate Current	135 max	mA
Plate Dissipation	3.8 max	watts
Peak Heater-Cathode Voltages:		
Heater negative with respect to cathode	4200* max	volts
Heater positive with respect to cathode	200* max	volts
Bulb Temperature (At hottest point)	200 max	°C

#### CHARACTERISTICS, Instantaneous Value:

Tube Voltage Drop for plate current of 250 mA	21	volts
---	----	-------

# The duration of the voltage pulse must not exceed 15 per cent of one horizontal scanning cycle. In a 525-line, 30-frame system, 15 per cent of one horizontal scanning cycle is 10 microseconds.

\* The dc component must not exceed 400 volts.

\* The dc component must not exceed 100 volts.

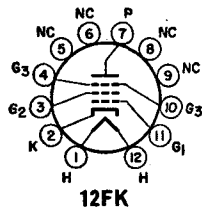

12FK

**BEAM POWER TUBE**

Duodecar type used as horizontal-deflection amplifier in television receivers. Outline 15B, **Outlines** section. Tube requires duodecar twelve-contact socket and may be mounted in any position. Heater volts (ac/dc), 33; am-

**33JV6**

peres, 0.3; average warm-up time, 11 seconds; peak heater-cathode volts, 200 (the dc component must not exceed 100 volts when the heater is positive with respect to the cathode).

**Class A<sub>1</sub> Amplifier**

**CHARACTERISTICS:**

Plate Voltage	5000	60	130	volts
Grid-No.3 (Suppressor-Grid)			Connected to cathode at socket	
Grid-No.2 (Screen-Grid) Voltage	130	130	130	volts
Grid-No.1 (Control-Grid) Voltage	—	0	—20	volts
Plate Resistance (Approx.)	—	—	11000	ohms
Transconductance	—	—	9100	μmhos
Plate Current	—	410	50	mA
Grid-No.1 Current	—	24	1.75	mA
Grid-No.1 Voltage (Approx.) for plate current of 1 mA	—66	—	—33	volts
Triode Amplification Factor*	—	—	4.7	

**Horizontal-Deflection Amplifier**

For operation in a 525-line, 30-frame system

**MAXIMUM RATINGS (Design-Maximum Values):**

DC Plate Supply Voltage	770 max	volts
Peak Positive-Pulse Plate Voltage#	6000 max	volts
Peak Negative-Pulse Plate Voltage	—1500 max	volts
DC Grid-No. 3 Voltage	70 max	volts
DC Grid-No.2 Voltage	220 max	volts
DC Grid-No.1 Voltage, Negative-bias value	—55 max	volts
Peak Negative-Pulse Grid-No.1 Voltage	—330 max	volts
Average Cathode Current	230 max	mA
Peak Cathode Current	800 max	mA
Plate Dissipation**	18 max	watts
Grid-No.2 Input	3.5 max	watts
Bulb Temperature (At hottest point)	220 max	°C

**MAXIMUM CIRCUIT VALUES:**

Grid-No.1-Circuit Resistance ..... 1 max megohm

\* Triode connection (grid No.2 tied to plate).

# The duration of the voltage pulse must not exceed 15 per cent of one horizontal scanning cycle. In a 525-line, 30-frame system, 15 per cent of one horizontal scanning cycle is 10 microseconds.

\*\* An adequate bias resistor or other means is required to protect the tube in the absence of excitation.

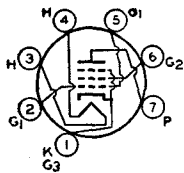

7CV

**BEAM POWER TUBE**

Miniature type used in audio output stages of compact ac/dc radio receivers. Outline 5D, **Outlines** section. Tube requires miniature seven-contact socket and may be operated in any position.

**34GD5A**

Heater Voltage (ac/dc)	34	volts
Heater Current	0.1	ampere

Heater Warm-up Time (Average) .....	20	seconds
Peak Heater-Cathode Voltage:		
Heater negative with respect to cathode .....	200 max	volts
Heater positive with respect to cathode .....	200 max	volts
Direct Interelectrode Capacitances (Approx.):		
Grid No.1 to Plate .....	0.6	pF
Grid No.1 to Cathode, Heater, Grid No.2, and Grid No.3 .....	12	pF
Plate to Cathode, Heater, Grid No.2, and Grid No.3 .....	9	pF

\* The dc component must not exceed 100 volts.

**Class A<sub>1</sub> Amplifier**

**MAXIMUM RATINGS (Design-Maximum Values):**

Plate Voltage .....	150 max	volts
Grid-No.2 (Screen-Grid) Voltage .....	130 max	volts
Grid-No.1 (Control-Grid) Voltage:		
Negative-bias value .....	50 max	volts
Positive-bias value .....	0 max	volts
Grid-No.2 Input .....	1.1 max	watts
Plate Dissipation .....	5 max	watts
Bulb Temperature (At hottest point) .....	250 max	°C

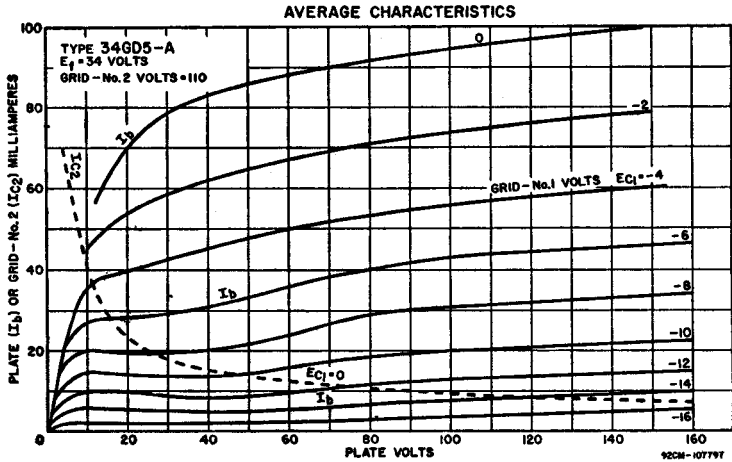

**TYPICAL OPERATION AND CHARACTERISTICS:**

Plate Voltage .....	110	volts
Grid-No.2 Voltage .....	110	volts
Grid-No.1 Voltage .....	-7.5	volts
Peak AF Grid-No.1 Voltage .....	7.5	volts
Zero-Signal Plate Current .....	35	mA
Zero-Signal Grid-No.2 Current .....	3	mA
Plate Resistance (Approx.) .....	13000	ohms
Transconductance .....	5700	μmhos
Load Resistance .....	2500	ohms
Total Harmonic Distortion .....	10	per cent
Maximum-Signal Power Output .....	1.4	watts

**MAXIMUM CIRCUIT VALUES:**

Grid-No.1-Circuit Resistance:		
For fixed-bias operation .....	0.1 max	megohm
For cathode-bias operation .....	0.5 max	megohm



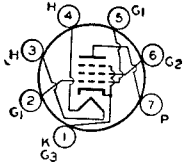

**BEAM POWER TUBE**

**35C5**

Miniature type used in output stage of compact, ac/dc radio receivers. Because of its high power sensitivity and high efficiency at plate and screen-grid voltages available in ac/dc receivers, the 35C5 is capable of providing a relatively high power output. Except for terminal connections and slightly higher ratings, type 35C5 is equivalent in performance to miniature type 35B5 and, within its maximum ratings, to glass octal type 35L6GT. The basing arrangement of the 35C5 simplifies the problem of meeting Underwriters' Laboratories requirements in the design of ac/dc receivers.

Heater Voltage (ac/dc)	35	volts
Heater Current	0.15	ampere
<b>Peak Heater-Cathode Voltage:</b>		
Heater negative with respect to cathode	200 max	volts
Heater positive with respect to cathode	200 max	volts
<b>Direct Interelectrode Capacitances (Approx.):</b>		
Grid No.1 to Plate	0.6	pF
Grid No.1 to Cathode, Heater, Grid No.2, and Grid No.3	12	pF
Plate to Cathode, Heater, Grid No.2, and Grid No.3	9	pF

• The dc component must not exceed 100 volts.

**Class A<sub>1</sub> Amplifier**

**MAXIMUM RATINGS** (Design-Maximum Values):

Plate Voltage	150 max	volts
Grid-No.2 (Screen-Grid) Voltage	130 max	volts
Plate Dissipation	5.2 max	watts
Grid-No.2 Input	1.1 max	watt
Bulb Temperature (At hottest point)	250 max	°C

**TYPICAL OPERATION:**

Plate Voltage	110	volts
Grid-No.2 Voltage	110	volts
Grid-No.1 (Control-Grid) Voltage	-7.5	volts
Peak AF Grid-No.1 Voltage	7.5	volts
Zero-Signal Plate Current	40	mA
Maximum-Signal Plate Current	41	mA
Zero-Signal Grid-No.2 Current	3	mA
Maximum-Signal Grid-No.2 Current	7	mA

**AVERAGE PLATE CHARACTERISTICS**  
PENTODE CONNECTION

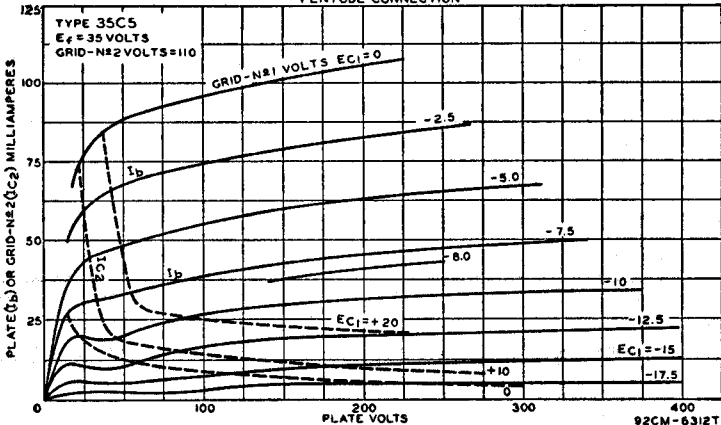

Plate Resistance (Approx.) .....	13000	ohms
Transconductance .....	5800	μmhos
Load Resistance .....	2500	ohms
Total Harmonic Distortion .....	10	per cent
Maximum-Signal Power Output .....	1.5	watts

**MAXIMUM CIRCUIT VALUES:**

Grid-No.1-Circuit Resistance:		
For fixed-bias operation .....	0.1 max	megohm
For cathode-bias operation .....	0.5 max	megohm

**Installation and Application**

Type 35C5 requires miniature seven-contact socket and may be mounted in any position. Outline 5D, **Outlines** section. It is especially important that this tube, like other power-handling tubes, should be adequately ventilated.

The 35-volt heater is designed to operate under the normal conditions of line-voltage variation without materially affecting the performance or serviceability of the 35C5. For operation of the 35C5 in series with other types having 0.15-ampere rating, the current in the heater circuit should be adjusted to 0.15 ampere for the normal supply voltage.

In a series-heater circuit of the "dc-power line" type employing several 0.15-ampere types and one or two 35C5s, the heater(s) of the 35C5(s) should be placed on the positive side of the line. Under these conditions, heater-cathode voltage of the 35C5 must not exceed the value given under maximum ratings. In a series-heater circuit of the "universal" type employing rectifier tube 35W4, one or two 35C5s and several 0.15-ampere types, it is recommended that the heater(s) of the 35C5(s) be placed in the circuit so that the higher values of heater-cathode bias will be impressed on the 35C5(s) rather than on the other 0.15-ampere types. This is accomplished by arranging the 35C5(s) on the side of the supply line which is connected to the cathode of the rectifier, i.e., the positive terminal of the rectified voltage supply. Between this side of the line and the 35C5(s), any necessary auxiliary resistance and the heater of the 35W4 are connected in series.

As a power amplifier (class A<sub>1</sub>), the 35C5 is recommended for use either singly or in push-pull combination in the power-output stage of ac/dc receivers. The operating values shown under typical operation have been determined on the basis that grid-No.1 current does not flow during any part of the input cycle.

**POWER PENTODE****35EH5**

Miniature type used in the audio output stage of radio and television receivers and in phonographs. This type has unusually high power sensitivity and is capable of providing relatively high power output at low plate and

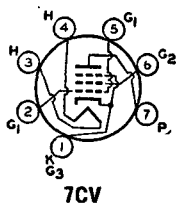

screen-grid voltages with a low af grid-No.1 driving voltage. Outline 5D, **Outlines** section. Tube requires miniature seven-contact socket and may be mounted in any position.

Heater Voltage (ac/dc) .....	35	volts
Heater Current .....	0.15	amperes
Peak Heater-Cathode Voltage:		
Heater negative with respect to cathode .....	200 max	volts
Heater positive with respect to cathode .....	200*max	volts
Direct Interelectrode Capacitances (Approx.):		
Grid No.1 to Plate .....	0.65	pF
Grid No.1 to Cathode, Heater, Grid No.2, and Grid No.3 .....	17	pF
Plate to Cathode, Heater, Grid No.2, and Grid No.3 .....	9	pF

\* The dc component must not exceed 100 volts.

**Class A<sub>1</sub> Amplifier**

**MAXIMUM RATINGS (Design-Maximum Values):**

Plate Voltage .....	150 max	volts
Grid-No.2 (Screen-Grid) Voltage .....	130 max	volts
Grid-No.1 (Control-Grid) Voltage, Positive-bias value .....	0 max	volts
Plate Dissipation .....	5 max	watts
Grid-No.2 Input .....	1.75 max	watts
Bulb Temperature (At hottest point) .....	225 max	°C

**TYPICAL OPERATION:**

Plate Supply Voltage .....	110	volts
Grid-No.2 Supply Voltage .....	115	volts
Cathode-Bias Resistor .....	62	ohms
Peak AF Grid-No.1 Voltage .....	3	volts
Zero-Signal Plate Current .....	32	mA
Maximum-Signal Plate Current .....	32	mA
Zero-Signal Grid-No.2 Current .....	7.2	mA
Maximum-Signal Grid-No.2 Current .....	12	mA
Plate Resistance (Approx.) .....	14000	ohms
Transconductance .....	3000	μmhos
Load Resistance .....	3000	ohms
Total Harmonic Distortion .....	8	per cent
Maximum-Signal Power Output .....	1.2	watts

**MAXIMUM CIRCUIT VALUES:**

Grid-No.1-Circuit Resistance:		
For fixed-bias operation .....	0.1 max	megohm
For cathode-bias operation .....	0.5 max	megohm

**AVERAGE CHARACTERISTICS**

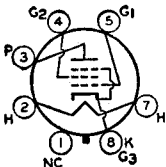
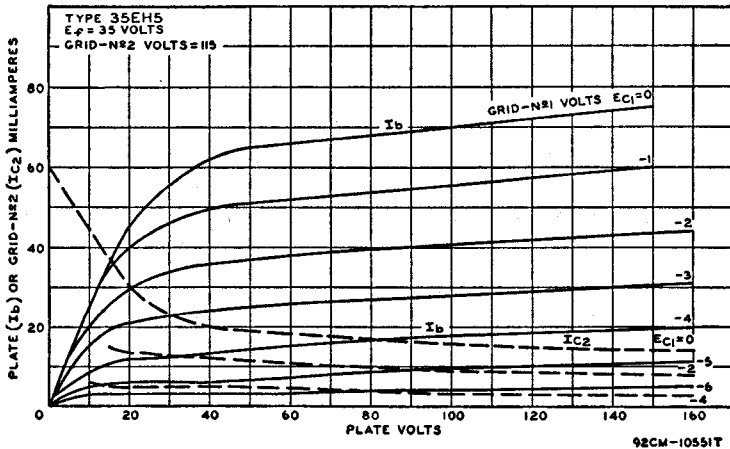

**TAC**

**BEAM POWER TUBE**

Glass octal type used in output stage of ac/dc radio receivers. Outline 13D, **Outlines** section. Tube requires octal socket and may be mounted in any position. This type may be supplied with pin No.1 omitted. Refer to miniature type 35C5 for installation, application information, and curves.

**35L6GT**

Refer to miniature type 35C5 for installation, application information, and curves.

Heater Voltage (ac/dc) .....	35	volts
Heater Current .....	0.15	ampere
Peak Heater-Cathode Voltage:		
Heater negative with respect to cathode .....	90 max	volts
Heater positive with respect to cathode .....	90 max	volts
Direct Interelectrode Capacitances (Approx.):		
Grid No.1 to Plate .....	0.6	pF
Grid No.1 to Cathode, Heater, Grid No.2, and Grid No.3 .....	13	pF
Plate to Cathode, Heater, Grid No.2, and Grid No.3 .....	9.5	pF

**Class A<sub>1</sub> Amplifier**

**MAXIMUM RATINGS (Design-Center Values):**

Plate Voltage .....	200 max	volts
Grid-No.2 (Screen-Grid) Voltage .....	125 max	volts
Plate Dissipation .....	8.5 max	watts
Grid-No.2 Input .....	1.0 max	watt

**TYPICAL OPERATION:**

	Fixed Bias	Cathode Bias	
Plate Supply Voltage .....	110	200	volts
Grid-No.2 Supply Voltage .....	110	125	volts
Grid-No.1 (Control-Grid) Voltage .....	-7.5	—	volts
Cathode-Bias Resistor .....	—	180	ohms
Peak AF Grid-No.1 Voltage .....	7.5	8	volts
Zero-Signal Plate Current .....	40	43	mA
Maximum-Signal Plate Current .....	41	43	mA
Zero-Signal Grid-No.2 Current .....	3	2	mA
Maximum-Signal Grid-No.2 Current .....	7	5.5	mA
Plate Resistance (Approx.) .....	14000	34000	ohms
Transconductance .....	5800	6100	μmhos
Load Resistance .....	2500	5000	ohms
Total Harmonic Distortion .....	10	10	per cent
Maximum-Signal Power Output .....	1.5	3.0	watts

**MAXIMUM CIRCUIT VALUES:**

Grid-No.-1-Circuit Resistance:		
For fixed-bias operation .....	0.1 max	megohm
For cathode-bias operation .....	0.5 max	megohm

**HALF-WAVE VACUUM RECTIFIER**

**35W4**

Miniature type used in power supply of ac/dc receivers. Equivalent in performance to glass-octal type 35Z5GT. The heater is provided with a tap for operation of a panel lamp.

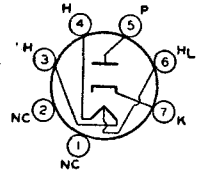

**5BQ**

Heater Voltage (ac/dc):	*	**	
Entire Heater (pins 3 and 4) .....	35	32	volts
Panel Lamp Section (pins 4 and 6) .....	7.5	5.5	volts
Heater Current:			
Between Pins 3 and 4 .....	0.15	—	ampere
Between Pins 3 and 6 .....	—	0.15	ampere
Peak Heater-Cathode Voltage:			
Heater negative with respect to cathode .....		360 max	volts
Heater positive with respect to cathode .....		360 max	volts

- \* Without panel lamp.
- \*\* With No.40 or No.47 panel lamp.

**Half-Wave Rectifier**

**MAXIMUM RATINGS (Design-Maximum Values):**

Peak Inverse Plate Voltage .....	360 max	volts
Peak Plate Current .....	660 max	mA
DC Output Current:		
With Panel Lamp and { No Shunting Resistor .....	66 max	mA
{ Shunting Resistor .....	100 max	mA
Without Panel Lamp .....	110 max	mA
Panel-Lamp-Section Voltage:		
When Panel Lamp Fails .....	17 max	volts

Installation and Application

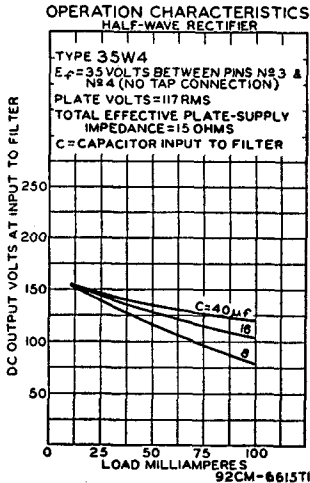

Tube requires miniature seven-contact socket and may be mounted in any position. Outline 5D, **Outlines** section. For heater considerations, refer to miniature type 35C5.

With the panel lamp connected as shown in the diagram, the drop across R and all heaters (with panel lamp) should equal 117 volts at 0.15 ampere. The shunting resistor  $R_s$  is required when dc output current exceeds 60 milliamperes. Values of  $R_s$  for dc output currents greater than 60 milliamperes are given in tabulated data.

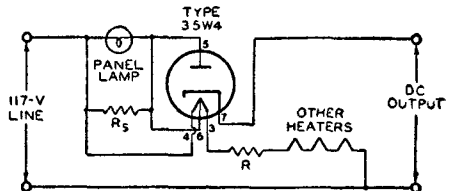

TYPICAL OPERATION WITH PANEL LAMP:†

AC Plate-Supply Voltage (rms)	117	117	117	117	volts
Filter-Input Capacitor	40	40	40	40	$\mu F$
Minimum Total Effective Plate-Supply Impedance	15	15	15	15	ohms
Panel-Lamp Shunting Resistor	—	300	150	100	ohms
DC Output Current	60	70	80	90	mA

† No.40 or No.47 panel lamp used in circuit given below with capacitor-input filter.

TYPICAL OPERATION WITHOUT PANEL LAMP:

AC Plate-Supply Voltage (rms)	117	volts
Filter-Input Capacitor	40	$\mu F$
Minimum Total Effective Plate-Supply Impedance	15	ohms
DC Output Current	100	mA
DC Output Voltage at Input to Filter (Approx.):		
At half-load current (50 mA)	135	volts
At full-load current (100 mA)	120	volts
Voltage Regulation (Approx.):		
Half-load to full-load current	15	volts

MAXIMUM CIRCUIT VALUES:

Panel-Lamp Shunting Resistor:\*

For dc output current of	70 mA	800 max	ohms
	80 mA	400 max	ohms
	90 mA	250 max	ohms

\* Required when dc output current is greater than 60 milliamperes.

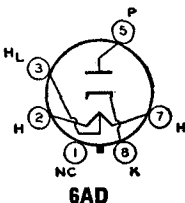

HALF-WAVE VACUUM RECTIFIER

Glass octal type used in power supply of ac/dc receivers. The heater is provided with a tap for operation of a panel lamp. Outline 13D, **Outlines** section. Tube requires octal socket and may be mounted in any position. This

35Z5GT

type may be supplied with pin No.1 omitted. For installation and application considerations, refer to miniature type 35W4.

<b>Heater Voltage (ac/dc):</b>		*	**	
Entire Heater (pins 2 and 7) .....	35		32	volts
Panel Lamp Section (pins 2 and 3) .....	7.5		5.5	volts
<b>Heater Current:</b>				
Between Pins 2 and 7 .....	0.15		—	ampere
Between Pins 3 and 7 .....	—		0.15	ampere
<b>Peak Heater-Cathode Voltage:</b>				
Heater negative with respect to cathode .....			350 max	volts
Heater positive with respect to cathode .....			350 max	volts

- \* Without panel lamp.
- \*\* With No.40 or No.47 panel lamp.

**Half-Wave Rectifier**

**MAXIMUM RATINGS (Design-Center Values):**

Peak Inverse Plate Voltage .....	700 max	volts
Peak Plate Current .....	600 max	mA
<b>DC Output Current:</b>		
With Panel Lamp and { No Shunting Resistor .....	60 max	mA
{ Shunting Resistor .....	90 max	mA
Without Panel Lamp .....	100 max	mA
<b>Panel-Lamp-Section Voltage (rms):</b>		
When Panel Lamp Fails .....	15 max	volts

**TYPICAL OPERATION WITH PANEL LAMP:†**

AC Plate-Supply Voltage (rms) .....	117	117	117	117	235	volts
Filter-Input Capacitor .....	40	40	40	40	40	μF
<b>Minimum Total Effective Plate-Supply Impedance</b>						
Supply Impedance .....	15	15	15	15	100	ohms
Panel-Lamp Shunting Resistor .....	—	300	150	100	—	ohms
DC Output Current .....	60	70	80	90	60	mA

† No.40 or No.47 panel lamp used in circuit with capacitor-input filter given under type 35W4.

**TYPICAL OPERATION WITHOUT PANEL LAMP:**

AC Plate-Supply Voltage (rms) .....	117	235	volts
Filter-Input Capacitor .....	40	40	μF
Minimum Total Effective Plate-Supply Impedance .....	15	100	ohms
DC Output Current .....	100	100	mA
<b>DC Output Voltage at Input to Filter (Approx.):</b>			
At half-load current (50 mA) .....	140	280	volts
At full-load current (100 mA) .....	120	235	volts
<b>Voltage Regulation (Approx.):</b>			
Half-load to full-load current .....	20	45	volts

**MAXIMUM CIRCUIT VALUES:**

<b>Panel-Lamp Shunting Resistor*:</b>			
For dc output current of { 70 mA .....	800 max	ohms	
{ 80 mA .....	400 max	ohms	
{ 90 mA .....	250 max	ohms	

- \* Required when dc output current is greater than 60 milliamperes.

**HALF-WAVE VACUUM RECTIFIER**

**36AM3B**

Miniature type used in power supply of ac/dc receivers. This type has a tapped heater so that the heater section between pins 4 and 6 can be used as a limiting resistance in the rectifier plate circuit. This heater section is not to be

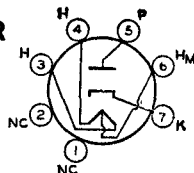

**5BQ**

used as a panel-lamp shunt. Outline 5D, **Outlines** section. Tube requires miniature seven-contact socket and may be operated in any position.

<b>Heater Voltage (ac/dc):</b>		
Entire Heater (Pins 3 and 4) .....	36	volts
Tap Section (Pins 3 and 6) .....	32	volts
Heater Current (Pins 3 and 6) .....	0.1	ampere
Heater Warm-up Time (Average) .....	20	seconds

**Peak Heater-Cathode Voltage:**

Heater negative with respect to cathode .....	350*max	volts
Heater positive with respect to cathode .....	200*max	volts

- The dc component must not exceed 350 volts.
- The dc component must not exceed 100 volts.

**Half-Wave Rectifier**

**MAXIMUM RATINGS (Design-Maximum Values):**

Peak Inverse Plate Voltage .....	365 max	volts
Peak Plate Current .....	580 max	mA
DC Output Current .....	82 max	mA

**TYPICAL OPERATION WITH CAPACITOR INPUT TO FILTER:**

AC Plate-Supply Voltage (rms) .....	120	117	volts
Filter-Input Capacitor .....	40	40	μF
Total Effective Plate Supply Resistance .....			See text above
DC Output Current .....	75	75	mA
DC Output Voltage .....	118	105	volts

**CHARACTERISTICS:**

Tube Voltage Drop for plate current of 150 mA .....	16	20	volts
---	----	----	-------

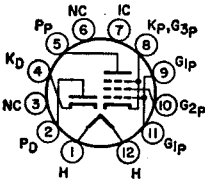

**DIODE—BEAM POWER TUBE**

Duodecar type used in a wide variety of applications in television receivers. The diode unit is used for damper service and the beam power unit for horizontal-deflection amplifier service. Outline 15D, **Outlines** section. Tube

**38HE7**

requires duodecar twelve-contact socket and may be mounted in any position.

Heater Voltage (ac/dc) .....	37.8	volts
Heater Current .....	0.45	ampere
Heater Warm-up Time (Average) .....	11	seconds
<b>Peak Heater-Cathode Voltage:</b>		
Heater negative with respect to cathode .....	200 max	volts
Heater positive with respect to cathode .....	200*max	volts
<b>Direct Interelectrode Capacitances (Approx.):</b>		
<b>Diode Unit:</b>		
Plate to Cathode and Heater .....	7	pF
Cathode to Plate and Heater .....	8	pF
Heater to Cathode .....	1.6	pF
<b>Beam Power Unit:</b>		
Grid No.1 to Plate .....	0.38	pF
Grid No.1 to Cathode, Heater, Grid No.2, and Grid No.3 .....	19	pF
Plate to Cathode, Heater, Grid No.2, and Grid No.3 .....	8	pF

\* The dc component must not exceed 100 volts.

**Beam Power Unit as Class A<sub>1</sub> Amplifier**

**CHARACTERISTICS:**

Plate Voltage .....	5000	50	130	volts
Grid-No.2 (Screen-Grid) Voltage .....	130	130	130	volts
Grid-No.1 (Control-Grid) Voltage .....	—	0	-22	volts
Plate Resistance (Approx.) .....	—	—	6200	ohms
Transconductance .....	—	—	8800	μmhos
Grid-No.1 Voltage (Approx.) for plate current of 1 mA .....	-80	—	-39	volts
Plate Current .....	—	450	60	mA
Grid-No.2 Current .....	—	40	2.8	mA
Triode Amplification Factor ** .....	—	—	4.2	

\*\* Triode connection (grid No.2 tied to plate).

**Beam Power Unit as Horizontal-Deflection Amplifier**

For operation in a 525-line, 30-frame system

**MAXIMUM RATINGS (Design-Maximum Ratings):**

Plate Voltage .....	500 max	volts
Peak Positive-Pulse Plate Voltage .....	5000 max	volts
Peak Negative-Pulse Plate Voltage .....	0 max	volts
Grid-No.2 Voltage .....	150 max	volts
DC Grid-No.1 DC Voltage, Negative-bias value .....	-55 max	volts
Peak Negative-Pulse Grid-No.1 Voltage .....	-330 max	volts
Average Cathode Current .....	230 max	mA
Peak Cathode Current .....	800 max	mA
Plate Dissipation † .....	10 max	watts
Grid-No.2 Input .....	3.5 max	watts

**MAXIMUM CIRCUIT VALUES:**

Grid-No.1-Circuit Resistance .....	1 max	megohm
------------------------------------	-------	--------

† An adequate bias resistor or other means is required to protect the tube in the absence of excitation.

**Damper Service—Diode Unit**

For operation in a 525-line, 30-frame system

**MAXIMUM RATINGS (Design-Maximum Values):**

Peak Inverse Plate Voltage †† .....	4200 max	volts
Peak Plate Current .....	1200 max	mA
Average Plate Current .....	200 max	mA
Peak Heater-Cathode Voltage:		
Heater negative with respect to cathode .....	4200□max	volts
Heater positive with respect to cathode .....	200□□max	volts
Bulb Temperature (at hottest point) .....	200 max	°C

**CHARACTERISTICS (Instantaneous Value):**

Tube Voltage Drop for plate current of 350 mA .....	21	volts
---	----	-------

†† The duration of the voltage pulse must not exceed 15 per cent of one horizontal scanning cycle. In a 525-line, 30-frame system, 15 per cent of one horizontal scanning cycle is 10 microseconds.

□ The dc component must not exceed 500 volts.

□□ The dc component must not exceed 100 volts.

**BEAM POWER TUBE****50B5**

Miniature type used in output stage of compact ac/dc receivers. Because of its high power sensitivity at plate and screen-grid voltages available in ac/dc receivers, it is capable of providing a relatively high power output. Outline

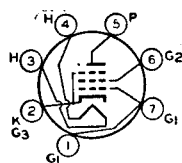
**7BZ**

5D, Outlines section. Tube requires miniature seven-contact socket and may be mounted in any position. Except for basing arrangement, type 50B5 is identical with miniature type 50C5.

**BEAM POWER TUBE****50C5**

Related types:  
17C5, 25C5

Miniature type used in output stage of compact, ac/dc radio receivers. Because of its high power sensitivity and high efficiency at plate and screen-grid voltages available in ac/dc receivers, the 50C5 is capable of providing

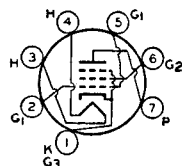
**7CV**

ing a relatively high power output. Within its maximum ratings, type 50C5 is



equivalent in performance to glass octal type 50L6GT. The basing arrangement of the 50C5 simplifies the problem of meeting Underwriters' Laboratories requirements in the design of ac/dc receivers. Types 17C5 and 25C5 are identical with type 50C5 except for the heater ratings, as shown below.

	17C5	25C5	50C5	
Heater Voltage (ac/dc)	16.8	25	50	volts
Heater Current	0.45	0.3	0.15	ampere
Heater Warm-up Time (Average)	11	—	—	seconds
<b>Peak Heater-Cathode Voltage:</b>				
Heater negative with respect to cathode	200 max	200 max	200 max	volts
Heater positive with respect to cathode	200 max	200 max	200 max	volts
<b>Direct Interelectrode Capacitances (Approx.):</b>				
Grid No.1 to Plate			0.6	pF
Grid No.1 to Cathode, Heater, Grid No.2, and Grid No.3			13	pF
Plate to Cathode, Heater, Grid No.2, and Grid No.3			8.5	pF

• The dc component must not exceed 100 volts.

**Class A<sub>1</sub> Amplifier**

**MAXIMUM RATINGS (Design-Maximum Values):**

Plate Voltage	150 max	volts
Grid-No.2 (Screen-Grid) Voltage	130 max	volts
Grid-No.1 (Control-Grid) Voltage, Positive-bias value	0 max	volts
Plate Dissipation	7 max	watts
Grid-No.2 Input	1.4 max	watts
Bulb Temperature (At hottest point)	220 max	°C

**TYPICAL OPERATION:**

Plate Voltage	120	volts
Grid-No.2 Voltage	110	volts
Grid-No.1 (Control-Grid) Voltage	-8	volts
Peak AF Grid-No.1 Voltage	8	volts
Zero-Signal Plate Current	49	mA
Maximum-Signal Plate Current	50	mA
Zero-Signal Grid-No.2 Current	4	mA
Maximum-Signal Grid-No.2 Current	8.5	mA
Plate Resistance (Approx.)	10000	ohms
Transconductance	7500	μmhos

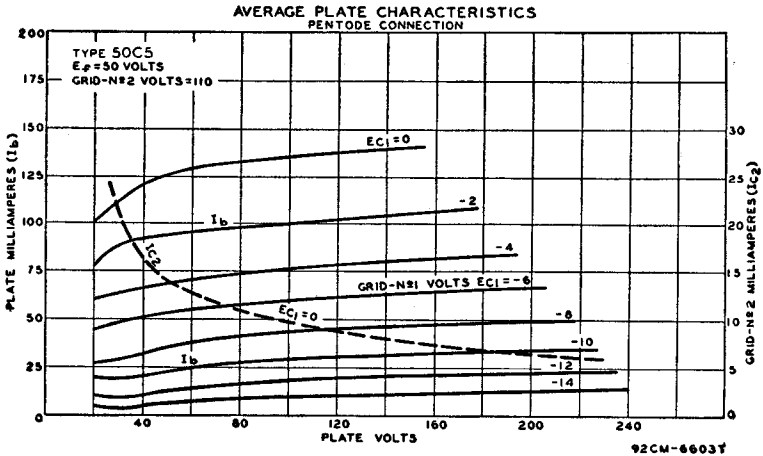

Load Resistance	2500	ohms
Total Harmonic Distortion	10	per cent
Maximum-Signal Power Output	2.3	watts

**MAXIMUM CIRCUIT VALUES:**

<b>Grid-No.1-Circuit Resistance:</b>		
For fixed-bias operation	0.1 max	megohm
For cathode-bias operation	0.5 max	megohm

**Installation and Application**

Type 50C5 requires miniature seven-contact socket and may be mounted in any position. Outline 5D, **Outlines** section. It is especially important that this tube, like other power-handling tubes, be adequately ventilated.

The 50-volt heater is designed to operate under the normal conditions of line-voltage variation without materially affecting the performance or serviceability of the 50C5. For operation of the 50C5 in series with other types having 0.15-ampere rating, the current in the heater circuit should be adjusted to 0.15 ampere for the normal supply voltage.

In a series-heater circuit of the "dc power line" type employing several 0.15-ampere types and one or two 50C5s, the heater (s) of the 50C5(s) should be placed on the positive side of the line. Under these conditions, heater-cathode voltage of the 50C5 must not exceed the value given under maximum ratings. In a series-heater circuit of the "universal" type employing rectifier tube 35W4, one or two 50C5s, and several 0.15-ampere types, it is recommended that the heater(s) of the 50C5(s) be placed in the circuit so that the higher values of heater-cathode bias will be impressed on the 50C5(s) rather than on the other 0.15-ampere types. This is accomplished by arranging the 50C5(s) on the side of the supply line which is connected to the cathode of the rectifier, i.e., the positive terminal of the rectified voltage supply. Between this side of the line and the 50C5(s), any necessary auxiliary resistance and the heater of the 35W4 are connected in series.

As a power amplifier (class A<sub>1</sub>), the 50C5 is recommended for use either singly or in push-pull combination in the power-output stage of "ac/dc" receivers. The operating values shown under typical operation have been determined on the basis that grid-No.1 current does not flow during any part of the input cycle.

**HALF-WAVE VACUUM RECTIFIER**

**50DC4**

Miniature type used in power supply of ac/dc radio receivers. The heater is provided with a tap for operation of a panel lamp. For typical circuit, refer to type 35W4. Outline 5D, **Outlines** section. Tube requires seven-contact

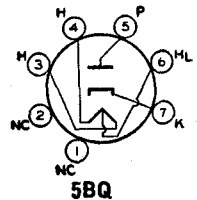

socket and may be mounted in any position.

Heater Voltage (ac/dc):	*	**	volts
Entire Heater (Pins 3 and 4) .....	50	45	volts
Panel-Lamp Section (Pins 4 and 6) .....	7.5	5.5	volts
Heater Current:			
Between Pins 3 and 4 .....	0.15	—	ampere
Between Pins 3 and 6 .....	—	0.15	ampere
Peak Heater-Cathode Voltage:			
Heater negative with respect to cathode .....		330 max	volts
Heater positive with respect to cathode .....		330 max	volts

\* Without panel lamp.

\*\*With No.40 or No.47 panel lamp.

**Half-Wave Rectifier**

**MAXIMUM RATINGS (Design-Maximum Values):**

Peak Inverse Plate Voltage .....	330 max	volts
Peak Plate Current .....	720 max	mA
DC Output Current:		
With Panel Lamp and { No Shunting Resistor .....	70 max	mA
{ Shunting Resistor* .....	110 max	mA
Without Panel Lamp .....	120 max	mA
Panel-Lamp-Section Voltage (rms):		
When Panel Lamp Fails .....	16.5 max	volts

**TYPICAL OPERATION WITH PANEL LAMP:†**

AC Plate-Supply Voltage (rms) . . . . .	117	117	117	117	volts
Filter-Input Capacitor . . . . .	40	40	40	40	μF
Minimum Total Effective Plate-Supply Impedance . . . . .	15	15	15	15	ohms
Panel-Lamp Shunting Resistor . . . . .	450	200	100	75	ohms
DC Output Current . . . . .	70	80	90	100	mA

**TYPICAL OPERATION WITHOUT PANEL LAMP:**

AC Plate-Supply Voltage (rms) . . . . .				117	volts
Filter-Input Capacitor . . . . .				40	μF
Minimum Total Effective Plate-Supply Impedance . . . . .				15	ohms
DC Output Current . . . . .				110	mA
DC Output Voltage at Input to Filter (Approx.):					
At half-load current (55 mA) . . . . .				130	volts
At full-load current (110 mA) . . . . .				110	volts
Voltage Regulation (Approx.):					
Half-load to full-load current . . . . .				20	volts

† No.40 or No.47 panel lamp used in circuit with capacitor-input filter given under type 35W4.  
 • Required when dc output current is greater than 70 milliamperers.

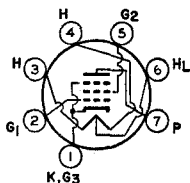

**7FZ**

**POWER PENTODE**

Miniature type used in the audio-frequency power output of radio receivers. Heater is provided with a tap for operation of a panel lamp. Outline 5D, **Outlines** section. Tube requires miniature seven-contact socket and

**50HC6**

may be mounted in any position.

Heater Voltage (ac/dc) . . . . .	50	volts
Heater Current . . . . .	0.15	ampere
Heater Tap Voltage (without panel lamp) . . . . .	7	volts
Peak Heater-Cathode Voltage:		
Heater negative with respect to cathode . . . . .	200 max	volts
Heater positive with respect to cathode . . . . .	200*max	volts
Direct Interelectrode Capacitances (Approx.):		
Grid No.1 to Plate . . . . .	0.5	pF
Grid No.1 to Cathode, Heater, Grid No.2, and Grid No.3 . . . . .	17	pF
Plate to Cathode, Heater, Grid No.2, and Grid No.3 . . . . .	9	pF

\* The dc component must not exceed 100 volts.

**MAXIMUM RATINGS (Design-Maximum Values):**

RMS Heater-Tap Voltage, when panel lamp fails . . . . .	14 max	volts
Plate Voltage . . . . .	150 max	volts
Grid-No.2 (Screen-Grid) Voltage . . . . .	130 max	volts
Plate Dissipation . . . . .	5.5 max	watts
Grid-No.2 Input . . . . .	2 max	watts

**CHARACTERISTICS:**

Plate Supply Voltage . . . . .	110	volts
Grid-No.2 Voltage . . . . .	115	volts
Peak AF Grid-No.1 (Control-Grid) Voltage . . . . .	3	volts
Cathode-Bias Resistor . . . . .	62	ohms
Zero-Signal Plate Current . . . . .	42	mA
Maximum-Signal Plate Current . . . . .	42	mA
Zero-Signal Grid-No.2 Current . . . . .	11.5	mA
Maximum-Signal Grid-No.2 Current . . . . .	14.5	mA
Plate Resistance (Approx.) . . . . .	11000	ohms
Transconductance . . . . .	14600	μmhos
Load Resistance . . . . .	3000	ohms
Total Harmonic Distortion (Approx.) . . . . .	7	per cent
Maximum-Signal Power Output . . . . .	1.4	watts

**POWER PENTODE**

**50HK6**

Miniature type used in audio-frequency power-output stage of radio receivers. Outline 5D, Outlines section. Tube requires miniature seven-contact socket and may be mounted in any position. The heater is provided with a tap for

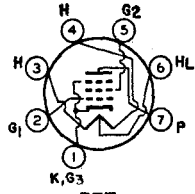

7FZ

operation of a panel lamp. Heater volts (ac/dc), 50; amperes, 0.15; tap volts (without panel lamp), 7; peak heater-cathode volts, 200 (the dc component must not exceed 100 volts when the heater is positive with respect to the cathode).

**Class A<sub>1</sub> Amplifier**

**MAXIMUM RATINGS (Design-Maximum Values):**

Plate Voltage .....	150 max	volts
Grid-No.2 (Screen-Grid) Voltage .....	130 max	volts
Plate Dissipation .....	5.5 max	watts
Grid-No.2 Input .....	1.1 max	watts
RMS Heater-Tap Voltage When Panel Lamp Fails .....	14 max	volts

**TYPICAL OPERATION AND CHARACTERISTICS:**

Plate Voltage .....	110	volts
Grid-No.2 Voltage .....	110	volts
Grid-No.1 (Control-Grid) Voltage .....	-7.5	volts
Peak AF Grid-No.1 Voltage .....	7.5	volts
Zero-Signal Plate Current .....	49	mA
Maximum-Signal Plate Current .....	50	mA
Zero-Signal Grid-No.2 Current .....	4	mA
Maximum-Signal Grid-No.2 Current .....	8.5	mA
Plate Resistance (Approx.) .....	10000	ohms
Transconductance .....	7500	μmhos
Load Resistance .....	2500	ohms
Total Harmonic Distortion (Approx.) .....	9	per cent
Maximum-Signal Power Output .....	1.9	watts

**MAXIMUM CIRCUIT VALUES:**

Grid-No.1-Circuit Resistance:		
For fixed-bias operation .....	0.1 max	megohm
For cathode-bias operation .....	0.5 max	megohm

**BEAM POWER TUBE**

**50L6GT**

Related type:  
25L6GT

Glass octal type used in output stage of ac/dc radio receivers. Outline 13D, Outlines section. Tube requires octal socket and may be mounted in any position. This type may be supplied with pin No.1 omitted. Refer to mini-

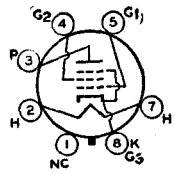

7AC

ature type 50C5 for installation and application information. Type 25L6GT is identical with type 50L6GT except for the heater ratings, as shown below.

	25L6GT	50L6GT	
Heater Voltage (ac/dc) .....	25	50	volts
Heater Current .....	0.3	0.15	ampere
Peak Heater-Cathode Voltage:			
Heater negative with respect to cathode .....	90 max	90 max	volts
Heater positive with respect to cathode .....	90 max	90 max	volts
Direct Interelectrode Capacitances (Approx.):			
Grid No.1 to Plate .....		0.6	pF
Grid No.1 to Cathode, Heater, Grid No.2, and Grid No.3 .....		15	pF
Plate to Cathode, Heater, Grid No.2, and Grid No.3 .....		9.5	pF

Class A<sub>1</sub> Amplifier

MAXIMUM RATINGS (Design-Center Values):

Plate Voltage .....	200 max	volts
Grid-No.2 (Screen-Grid) Voltage .....	125 max	volts
Plate Dissipation .....	10 max	watts
Grid-No.2 Input .....	1.25 max	watts

TYPICAL OPERATION:

	Fixed Bias	Cathode Bias	
Plate Supply Voltage .....	110	200	volts
Grid-No.2 Supply Voltage .....	110	125	volts
Grid-No.1 (Control-Grid) Voltage .....	-7.5	—	volts
Peak AF Grid-No.1 Voltage .....	7.5	8.0	volts

TYPICAL OPERATION AND CHARACTERISTICS:

	Fixed Bias	Cathode Bias	
Cathode-Bias Resistor .....	—	180	ohms
Zero-Signal Plate Current .....	49	46	mA
Maximum-Signal Plate Current .....	50	47	mA
Zero-Signal Grid-No.2 Current .....	4	2.2	mA
Maximum-Signal Grid-No.2 Current .....	10	8.5	mA
Plate Resistance (Approx.) .....	13000	28000	ohms
Transconductance .....	8000	8000	μmhos
Load Resistance .....	2000	4000	ohms
Total Harmonic Distortion .....	10	10	per cent
Maximum-Signal Power Output .....	2.1	3.8	watts

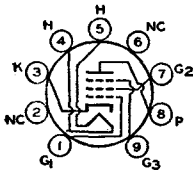

SHARP-CUTOFF PENTODE

Miniature type used as audio amplifier in applications requiring reduced microphonics, leakage noise, and hum. Especially useful in the input stages of medium-gain public-address systems, home sound recorders, and general-

5879

9AD

purpose audio systems. Outline 6B, **Outlines** section. Tube requires miniature nine-contact socket and may be mounted in any position. For operation as resistance-coupled amplifier, refer to **Resistance-Coupled Amplifier** section.

Heater Voltage (ac/dc) .....	6.3	volts
Heater Current .....	0.15	ampere
Peak Heater-Cathode Voltage:		
Heater negative with respect to cathode .....	100 max	volts
Heater positive with respect to cathode .....	100 max	volts

Direct Interelectrode Capacitances:

Pentode Connection:		
Grid No.1 to Plate .....	0.11 max	pF
Grid No.1 to Cathode, Heater, Grid No.2, and Grid No.3 .....	2.7	pF
Plate to Cathode, Heater, Grid No.2, and Grid No.3 .....	2.4	pF
Triode Connection*:		
Grid No.1 to Plate .....	1.4	pF
Grid No.1 to Cathode and Heater .....	1.4	pF
Plate to Cathode and Heater .....	0.85	pF

\* Grid No.2 and grid No.3 connected to plate.

Class A<sub>1</sub> Amplifier

MAXIMUM RATINGS (Design-Maximum Values):

	Triode Connection*	Pentode Connection	
Plate Voltage .....	275 max	330 max	volts
Grid-No.2 (Screen-Grid) Voltage .....	—	See curve page 80	
Grid-No.2 Supply Voltage .....	—	330 max	volts
Grid-No.1 (Control-Grid) Voltage:			
Negative-bias value .....	-55	-55 max	volts
Positive-bias value .....	0 max	0 max	volts
Plate Dissipation .....	1.7 max	1.25 max	watts
Grid-No.2 Input:			
For grid-No.2 voltages up to 165 volts .....	—	0.25 max	watt.
For grid-No.2 voltages between 165 and 330 volts .....	—	See curve page 80	

**CHARACTERISTICS:**

Plate Voltage	.....	.100	250	250	volts
Grid-No.3 Voltage	.....	—	—	Connected to cathode at socket	
Grid-No.2 Voltage	.....	—	—	100	volts
Grid-No.1 Voltage	.....	-3	-8	-3	volts
Amplification Factor	.....	21	21	—	
Plate Resistance (Approx.)	.....	0.017	0.0137	2	megohms
Transconductance	.....	1240	1530	1000	$\mu$ mhos
Grid-No.1 Voltage (Approx.) for plate current of 10 $\mu$ A	.....	—	—	-8	volts
Plate Current	.....	2.2	5.5	1.8	mA
Grid-No.2 Current	.....	—	—	0.4	mA

**MAXIMUM CIRCUIT VALUE:**

Grid-No.1-Circuit Resistance ..... 2.2 max megohms

\* Grid No.2 and grid No.3 connected to plate.

**AVERAGE CHARACTERISTICS  
TRIODE CONNECTION**

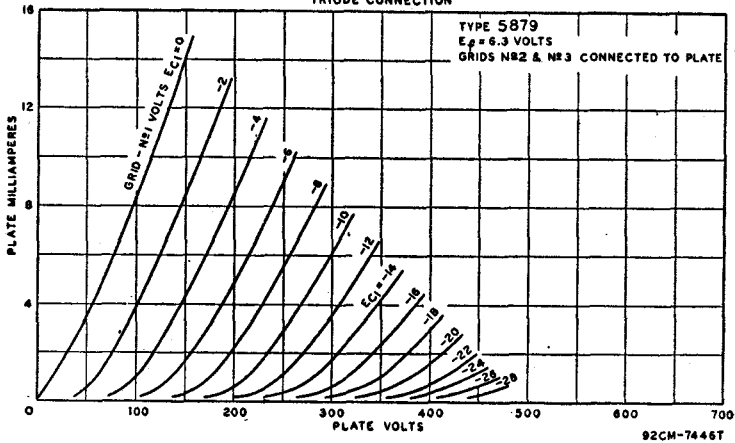

**AVERAGE CHARACTERISTICS  
PENTODE CONNECTION**

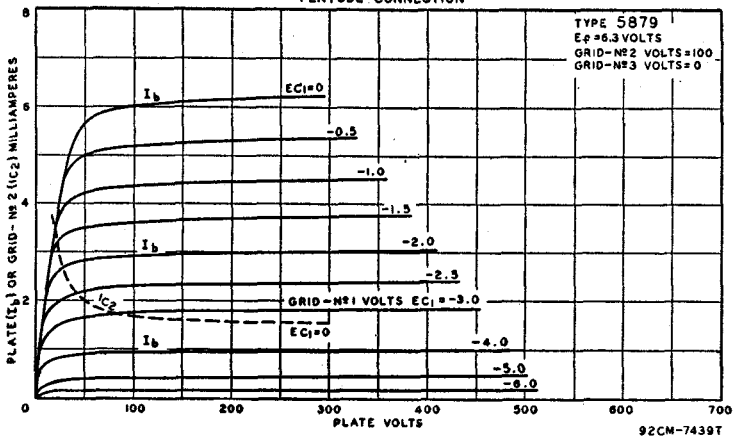

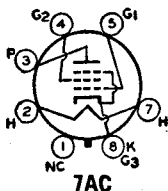

**BEAM POWER TUBE**

Glass octal type used in the output stages of radio receivers and audio amplifiers, particularly in the push-pull stages of high-fidelity audio amplifiers. Outline 29M, **Outlines** section. Tube requires octal socket and may be

**5881**

mounted in any position. For typical operation as push-pull class A<sub>1</sub>, class AB<sub>1</sub> (within maximum ratings), and class AB<sub>2</sub> amplifier, and for curves of average plate characteristics, refer to type 6L6GC. Heater volts (ac/dc), 6.3; amperes, 0.9; peak heater-cathode volts, 200 max.

**Class A<sub>1</sub> Amplifier**

**MAXIMUM RATINGS (Design-Center Values):**

Plate Voltage	400 max
Grid-No.2 (Screen-Grid) Voltage	—
Plate Dissipation	26 max
Grid-No.2 Input	—

<b>Triode Connection*</b>	<b>Pentode Connection</b>	
400 max	400 max	volts
—	400 max	volts
26 max	23 max	watts
—	3 max	watts

**TYPICAL OPERATION**

**AND CHARACTERISTICS:**

Plate Voltage	250	300	250	350	volts
Grid-No.2 Voltage	—	—	250	250	volts
Grid-No.1 (Control-Grid) Voltage	-18	-20	-14	-18	volts
Peak AF Grid-No.1 Voltage	18	20	14	18	volts
Zero-Signal Plate Current	52	78	75	53	mA
Maximum-Signal Plate Current	58	85	80	65	mA
Zero-Signal Grid-No.2 Current	—	—	4.3	2.5	mA
Maximum-Signal Grid-No.2 Current	—	—	7.6	8.5	mA
Amplification Factor	8	—	—	—	—
Plate Resistance (Approx.)	—	—	30000	48000	ohms
Transconductance	5250	—	6100	5200	μmhos
Load Resistance	4000	4000	2500	4200	ohms
Total Harmonic Distortion	6	5.5	10	13	per cent
Maximum-Signal Power Output	1.4	1.8	6.7	11.3	watts

**MAXIMUM CIRCUIT VALUES:**

Grid-No.1-Circuit Resistance:	
For fixed-bias operation	0.1 max megohm
For cathode-bias operation	0.5 max megohm

\* Grid No.2 connected to plate.

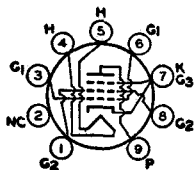

**BEAM POWER TUBE**

Miniature type used as power amplifier in compact high-fidelity audio equipment. Tube features linear operation over a wide range of power, high power sensitivity, high stability, and low heater power, and is capable of

**6973**

delivering high power output at low distortion. Double base-pin connections for both grid No.1 and grid No.2 provide cool operation of grids and thus minimize grid emission and permit use of high values of grid-circuit resistance to reduce driving power. Outline 6G, **Outlines** section. Tube requires miniature nine-contact socket and may be mounted in any position.

Heater Voltage (ac/dc)	6.3	volts
Heater Current	0.45	ampere
<b>Peak Heater-Cathode Voltage:</b>		
Heater negative with respect to cathode	200 max	volts
Heater positive with respect to cathode	200 max	volts
<b>Direct Interelectrode Capacitances:</b>		
Grid-No.1 to Plate	0.4 max	pF

Grid No.1 to Cathode, Heater, Grid No.2, and Grid No.3 .....	9	pF
Plate to Cathode, Heater, Grid No.2, and Grid No.3 .....	6	pF

▪ The dc component must not exceed 100 volts.

**Class A<sub>1</sub> Amplifier**

**CHARACTERISTICS:**

Plate Voltage .....	250	volts
Grid-No.2 (Screen-Grid) Voltage .....	250	volts
Grid-No.1 (Control-Grid) Voltage .....	-15	volts
Plate Resistance (Approx.) .....	73000	ohms
Transconductance .....	4800	μmhos
Plate Current .....	46	mA
Grid-No.2 Current .....	3.5	mA
Grid-No.1 Voltage (Approx.) for plate current of 100 μA .....	-40	volts

**Push-Pull Class AB<sub>1</sub> Amplifier**

**MAXIMUM RATINGS (Design-Maximum Values):**

Plate Voltage .....	440 max	volts
Grid-No.2 Voltage .....	330 max	volts
Plate Dissipation .....	12 max	watts
Grid-No.2 Input .....	2 max	watts
Bulb Temperature (At hottest point) .....	250 max	°C

AVERAGE CHARACTERISTICS  
WITH  $E_{C2}$  AS VARIABLE

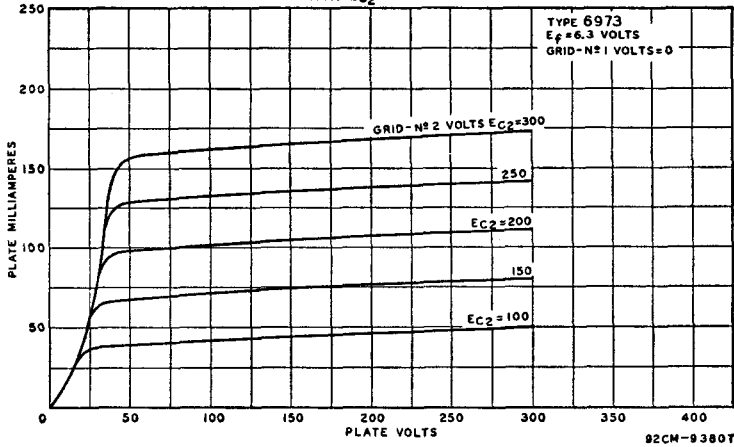

AVERAGE CHARACTERISTICS  
WITH  $E_{C1}$  AS VARIABLE

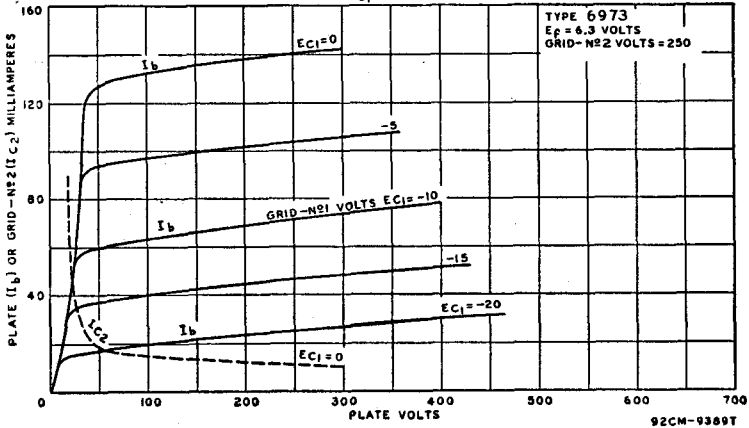



**TYPICAL OPERATION**

(Values are for two tubes):

	Fixed Bias			Cathode Bias		
Plate Supply Voltage	250	350	400	300	310	volts
Grid-No.2 Supply Voltage	250	280	290	300	310	volts
Grid-No.1 Voltage	-15	-22	-25	—	—	volts
Cathode-Bias Resistor	—	—	—	230	270	ohms
Peak AF Grid-No.1-to-Grid-No.1 Voltage	30	44	50	48	55	volts
Zero-Signal Plate Current	92	58	50	80	77	mA
Maximum-Signal Plate Current	105	106	107	96	92	mA
Zero-Signal Grid-No.2 Current	7	3.5	2.5	6	5	mA
Maximum-Signal Grid-No.2 Current	16	14	13.7	14	14	mA
Effective Load Resistance (Plate-to-plate)	8000	7500	8000	5500	6000	ohms
Total Harmonic Distortion	2	1.5	2	2	4	per cent
Maximum-Signal Power Output	12.5	20	24	15	17	watts

**MAXIMUM CIRCUIT VALUES:**

Grid-No.1-Circuit Resistance:

For fixed-bias operation	0.5 max	megohm
For cathode-bias operation	1 max	megohm

**Push-Pull Class AB<sub>1</sub> Amplifier**

Grid No.2 of Each Tube Connected to Tap on Plate Winding of Output Transformer

**MAXIMUM RATINGS (Design-Maximum Values):**

Plate and Grid-No.2 Supply Voltage	410 max	volts
Plate Dissipation	12 max	watts
Grid-No.2 Input	1.75 max	watts
Bulb Temperature (At hottest point)	250 max	°C

**TYPICAL OPERATION (Values are for two tubes):**

	Fixed Bias	Cathode Bias	
Plate Supply Voltage	375	370	volts
Grid-No.2 Supply Voltage	*	#	volts
Grid-No.1 Voltage*	-33.5	—	volts
Cathode-Bias Resistor	—	355	ohms
Peak AF Grid-No.1-to-Grid-No.1 Voltage	67	62	volts
Zero-Signal Cathode Current	62	74	mA
Maximum-Signal Cathode Current	95	84	mA
Effective Load Resistance (Plate-to-plate)	12500	13000	ohms
Total Harmonic Distortion	1.5	1.2	per cent
Maximum-Signal Power Output	18.5	15	watts

**MAXIMUM CIRCUIT VALUES:•**

Grid-No.1-Circuit Resistance:

For fixed-bias operation	0.5 max	megohm
For cathode-bias operation	1 max	megohm

\* Obtained from taps on the primary winding of the output transformer. The taps are located on each side of the center tap (B+) so as to apply 50 per cent of the plate signal voltage to grid No.2 of each output tube.

# Obtained from taps on the primary winding of the output transformer. The taps are located on each side of the center tap (B+) so as to supply 43 per cent of the plate signal voltage to grid No.2 of each output tube.

• The type of input-coupling network used should not introduce too much resistance in the grid-No.1 circuit. Transformer- or impedance-coupling-devices are recommended.

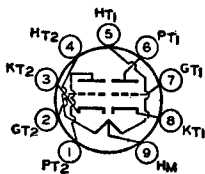

9A

**HIGH-MU TWIN TRIODE**

Miniature type used as phase inverter or resistance-coupled amplifier in high-quality, high-fidelity audio amplifiers where low noise and hum are primary considerations. Outline 6B, Outlines

**7025**

section. This type is identical with miniature type 12AX7A except that it has a controlled equivalent noise and hum characteristic. For operation as resistance-coupled amplifier, refer to **Resistance-Coupled Amplifier** section.

**EQUIVALENT-NOISE AND HUM VOLTAGE**

**REFERENCE TO GRID (Each Unit):**

Average Value (rms)†	1.8	μV
Maximum Value (rms)*	7	μV

† Measured in "true rms" units under following conditions: heater volts (ac), 6.3 (parallel connection); center tap of heater transformer connected to ground; plate supply volts, 250; plate load resistor, 2700 ohms; cathode-bypass capacitor, 100 μF; grid resistor, 0 ohms; and amplifier covering frequency range between 25 to 10000 cycles per second.

\* Same conditions as for "Average Value" except: cathode resistor is unbypassed and grid resistor, 0.05 megohm.

**BEAM POWER TUBE**

**7027A**

Glass octal type used in push-pull power amplifier circuits of high-fidelity audio equipment. Tube provides high power sensitivity and high stability and is capable of delivering high power output at low distortion. Double base-

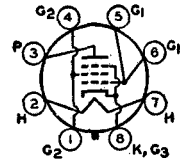

**8HY**

pin connections for both grid No.1 and grid No.2 provide for flexibility of circuit arrangement and also cool operation of the grids with the result that reverse grid current is minimized. Outline 19F, **Outlines** section. Tube requires octal socket and may be mounted in any position. It is especially important that this tube, like other power-handling tubes, be adequately ventilated.

Heater Voltage (ac/dc)	6.3	volts
Heater Current	0.9	ampere
<b>Peak Heater-Cathode Voltage:</b>		
Heater negative with respect to cathode	200 max	volts
Heater positive with respect to cathode	200*max	volts
<b>Direct Interelectrode Capacitances (Approx.):</b>		
Grid No.1 to Plate	1.5	pF
Grid No.1 to Cathode, Heater, Grid No.2, and Grid No.3	10	pF
Plate to Cathode, Heater, Grid No.2 and Grid No.3	7.5	pF

\* The dc component must not exceed 100 volts.

**Class A<sub>1</sub> Amplifier**

**CHARACTERISTICS:**

Plate Voltage	250	volts
Grid-No.2 (Screen-Grid) Voltage	250	volts
Grid-No.1 (Control-Grid) Voltage	-14	volts
Plate Resistance (Approx.)	22500	ohms
Transconductance	6000	μmhos
Plate Current	72	mA
Grid-No.2 Current	5	mA

**Push-Pull Class AB<sub>1</sub> Amplifier**

**MAXIMUM RATINGS (Design-Maximum Values):**

Plate Voltage	600 max	volts
Grid-No.2 Voltage	500 max	volts
Plate Dissipation	35 max	watts
Grid-No.2 Input	5 max	watts

**TYPICAL OPERATION (Values are for two tubes):**

	Fixed Bias			Cathode Bias			
Plate Supply Voltage	400	450	540	400	380	425	volts
Grid-No.2 Supply Voltage	300	350	400	300	380	415	volts
Grid-No.1 Voltage	-25*	-30*	-38*	—	—	—	volts
Cathode-Bias Resistor	—	—	—	200	180	200	ohms
Peak AF Grid-No.1-to-Grid-No.1 Voltage	50	60	76	57	68.5	86	volts
Zero-Signal Plate Current	102	95	100	112	138	150	mA
Maximum-Signal Plate Current	152	194	220	128	170	196	mA
Zero-Signal Grid-No.2 Current	6	3.4	5	7	5.6	8	mA
Maximum-Signal Grid-No.2 Current	17	19.2	21.4	16	20	20	mA

Effective Load Resistance (Plate-to-Plate) .....	6600	6000	6500	6600	4500	3800	ohms
Total Harmonic Distortion .....	2	1.5	2	2	3.5	4	per cent
Maximum-Signal Power Output .....	34	50	76	32	36	44	watts

**MAXIMUM CIRCUIT VALUES:**

Grid-No.1-Circuit Resistance:

For fixed-bias operation*	0.1 max megohm
For cathode-bias operation .....	0.5 max megohm

\* The type of input coupling network used should not introduce too much resistance in the grid-No.1 circuit. Transformer- or impedance-coupling devices are recommended.

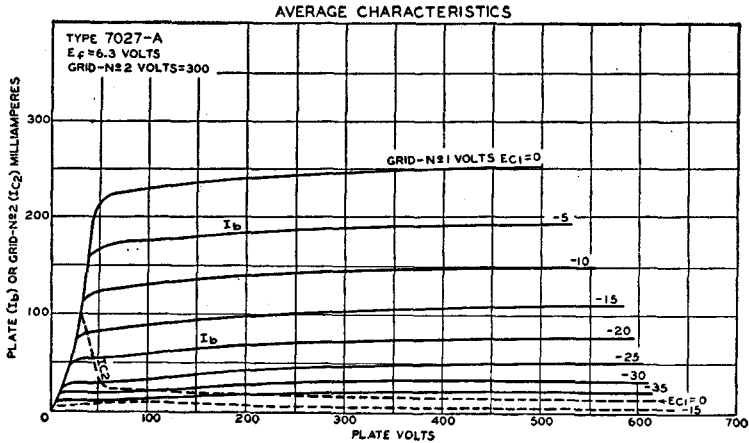
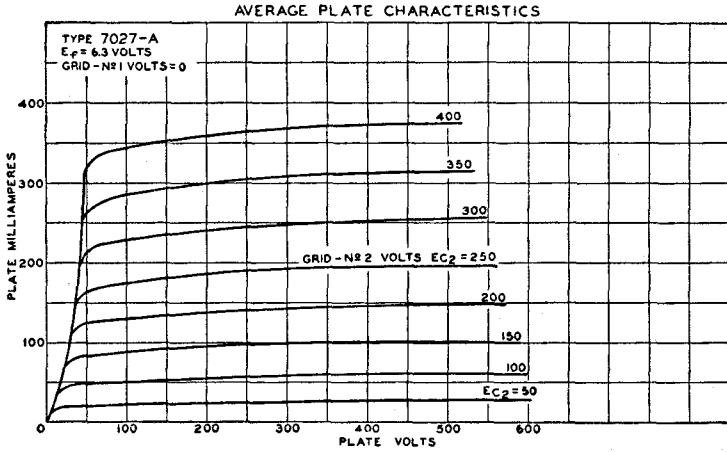

**Push-Pull Class AB<sub>1</sub> Amplifier**

Grid No.2 of Each Tube Connected to Tap on Plate Winding of Output Transformer

**MAXIMUM RATINGS (Design-Maximum Values):**

Plate and Grid-No.2 Supply Voltage .....	600 max	volts
Plate Dissipation .....	35 max	watts
Grid-No.2 Input .....	4.5 max	watts

**TYPICAL OPERATION** (Values are for two tubes):

Plate Supply Voltage .....	410	volts
Grid-No.2 Supply Voltage .....	*	volts
Cathode-Bias Resistor .....	220	ohms
Peak AF Grid-No.1-to-Grid-No.1 Voltage .....	68	volts
Zero-Signal Cathode Current .....	134	mA
Maximum-Signal Cathode Current .....	155	mA
Effective Load Resistance (Plate to plate) .....	8000	ohms
Total Harmonic Distortion .....	1.6	per cent
Maximum-Signal Power Output .....	24	watts

**MAXIMUM CIRCUIT VALUES:**

Grid-No.1-Circuit Resistance:	
For cathode-bias operation .....	0.5 max megohm

\* Obtained from taps on the primary winding of the output transformer. The taps are located on each side of the center tap (B+) so as to apply 43 per cent of the plate signal voltage to grid No.2 of each output tube.

**POWER PENTODE****7189**

Miniature type used as power amplifier tube in high-fidelity audio equipment. Outline 6G, **Outlines** section. Tube requires miniature nine-contact socket and may be mounted in any position. Heater volts (ac/dc), 6.3; amperes, 0.76; peak heater-cathode volts, 100 max.

**B10****Class A<sub>1</sub> Amplifier****CHARACTERISTICS:**

Plate Voltage .....	250	volts
Grid-No.2 (Screen-Grid) Voltage .....	250	volts
Grid-No.1 (Control-Grid) Voltage .....	-7.3	volts
Mu-Factor, Grid No.2 to Grid No.1 .....	19.5	
Plate Resistance (Approx.) .....	40000	ohms
Transconductance .....	11300	μmhos
Plate Current .....	48	mA
Grid-No.2 Current .....	5.5	mA

**Push-Pull Class AB<sub>1</sub> Amplifier****MAXIMUM RATINGS** (Design-Center Values):

Plate Voltage .....	400 max		
Grid-No.2 Voltage .....	300 max		
Cathode Current .....	65 max	65 max	mA
Plate Dissipation .....	12 max	12 max	watts
Zero-Signal Grid-No.2 Input .....	2 max	2 max	watts
Maximum-Signal Grid-No.2 Input .....	4 max	4 max	watts

Grid-No.2  
Special  
Connection\***TYPICAL OPERATION** (Values are for two tubes):

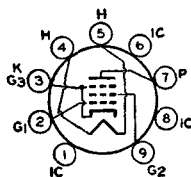
Plate Supply Voltage .....	—	375	volts
Plate Voltage .....	400	—	volts
Grid-No.2 Supply Voltage .....	—	•	
Grid-No.2 Voltage .....	300	•	volts
Grid-No.1 Voltage .....	-15	—	volts
Cathode-Bias Resistor .....	—	220	ohms
Peak AF Grid-No.1 Voltage .....	14.8	17.7	volts
Zero-Signal Plate Current .....	15	70	mA
Maximum-Signal Plate Current .....	105	81	mA
Zero-Signal Grid-No.2 Current .....	1.6	•	mA
Maximum-Signal Grid-No.2 Current .....	25	•	mA
Effective Load Resistance (Plate-to-plate) .....	8000	11000	ohms
Total Harmonic Distortion .....	4	3	per cent
Maximum-Signal Power Output .....	24	16.5	watts

**MAXIMUM CIRCUIT VALUES:**

Grid-No.1-Circuit Resistance .....

Fixed Bias  
0.3 max

Cathode Bias  
1 max megohm

- Grid No.2 of each tube connected to tap on plate winding of output transformer.
- Obtained from taps on primary winding of the output transformer. The taps are located on each side of the center tap (B+) so as to supply 43 per cent of the plate signal voltage to grid No.2 of each output tube.

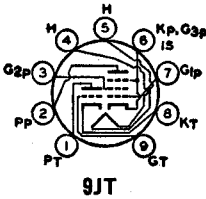

9JT

**MEDIUM-MU TRIODE—  
SHARP-CUTOFF PENTODE**

7199

Miniature type used in a wide variety of applications in high-quality, high-fidelity audio equipment, particularly in phase-splitters, tone-control amplifiers, and high-gain voltage amplifiers in which low hum and reduced noise

are required. Outline 6B, **Outlines** section. Tube requires miniature nine-contact socket and may be mounted in any position. For operation as resistance-coupled amplifier, refer to **Resistance-Coupled Amplifier** section. In direct-coupled voltage-amplifier phase-splitter circuits, the pentode unit should drive the triode unit.

Heater Voltage (ac/dc) .....	6.3	volts
Heater Current .....	0.45	ampere
<b>Peak Heater-Cathode Voltage:</b>		
Heater positive with respect to cathode .....	200 max	volts
Heater negative with respect to cathode .....	200•max	volts
<b>Direct Interelectrode Capacitances:</b>		
<b>Triode Unit:</b>		
Grid to Plate .....	2	pF
Grid to Cathode and Heater .....	2.3	pF
Plate to Cathode and Heater .....	0.3	pF
<b>Pentode Unit:</b>		
Grid No.1 to Plate .....	0.06 max	pF
Grid No.1 to Cathode, Heater, Grid No.2, Grid No.3, and Internal Shield .....	5	pF
Plate to Cathode, Heater, Grid No.2, Grid No.3, and Internal Shield .....	2	pF

• The dc component must not exceed 100 volts.

**EQUIVALENT-NOISE AND HUM VOLTAGE REFERENCED TO GRID:**

	Triode Unit	Pentode Unit	
Median Value (rms) .....	10†	35•	μV
Maximum Value (rms) .....	150†	100•	μV

† Measured in "true rms" units under the following conditions: heater volts (ac), 6.3; center tap of heater transformer connected to ground; plate-supply volts, 250; plate load resistor, 0.1 megohm; cathode resistor, 1500 ohms; grid resistor, 0.05 megohm; and amplifier covering frequency range between 25 and 10000 cycles per second.

• Same conditions as for triode unit except: grid-No.2 supply volts, 250; grid-No.2 resistor, 0.33 megohm; grid-No.2-bypass capacitor, 0.22 μF; cathode resistor, 1200 ohms; and grid-No.1 resistor, 0.05 megohm.

**Class A<sub>1</sub> Amplifier**

<b>MAXIMUM RATINGS (Design-Maximum Values):</b>	Triode Unit	Pentode Unit	
Plate Voltage .....	—	See curve page 80	
Grid-No.2 (Screen-Grid) Voltage .....	330 max	330 max	volts
Grid-No.2 Supply Voltage .....	—	330 max	volts
Grid-No.1 (Control-Grid) Voltage, Positive-bias value ..	0 max	0 max	volts
Plate Dissipation .....	2.4 max	3 max	watts
<b>Grid-No.2 Input:</b>			
For grid-No.2 voltages up to 165 volts .....	—	0.6 max	watt
For grid-No.2 voltages between 165 and 330 volts ..	—	See curve page 80	

AVERAGE CHARACTERISTICS  
TRIODE UNIT

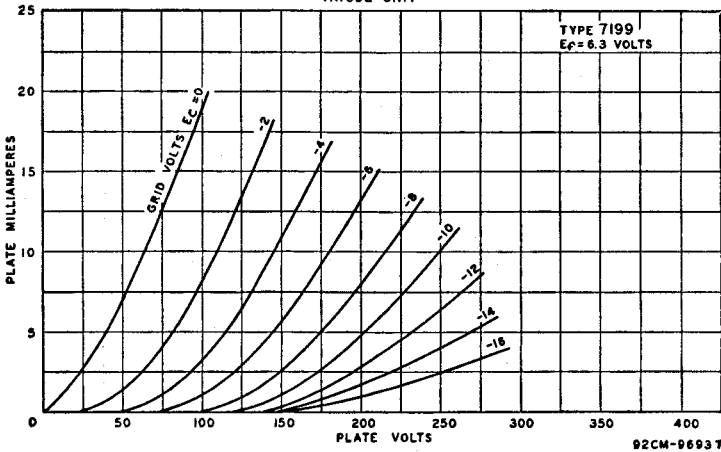

AVERAGE CHARACTERISTICS  
PENTODE UNIT

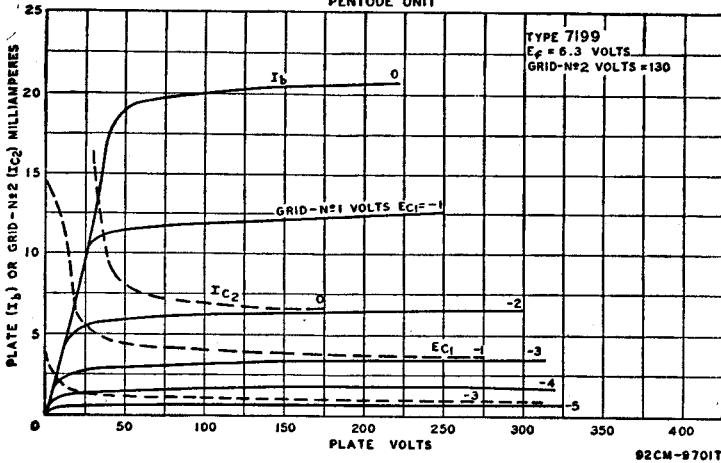

**CHARACTERISTICS:**

	Triode Unit	Pentode Unit	
Plate Supply Voltage .....	215	100	220 volts
Grid-No.2 Supply Voltage .....	—	50	130 volts
Grid-No.1 Voltage .....	-8.5	—	— volts
Cathode-Bias Resistor .....	—	1000	62 ohms
Amplification Factor .....	17	—	—
Plate Resistance (Approx.) .....	0.0081	1	0.4 megohm
Transconductance .....	2100	1500	7000 $\mu$ mhos
Grid-No.1 Voltage (Approx.) for plate current of 10 $\mu$ A .....	-40	-4	— volts
Plate Current .....	9	1.1	12.5 mA
Grid-No.2 Current .....	—	0.35	3.5 mA

**MAXIMUM CIRCUIT VALUES:**

Grid-No.1-Circuit Resistance:*	Triode Unit	Pentode Unit
For fixed-bias operation .....	0.5 max	0.25 max megohm
For cathode-bias operation .....	1.0 max	1.0 max megohm

\* If either unit is operated at maximum rated conditions, grid-No.1-circuit resistance for both units should not exceed the stated value.

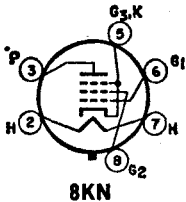

8KN

**POWER PENTODE**

Glass octal type used in the power-output stage of high-fidelity audio-frequency amplifier systems. Outline 13F, **Outlines** section. Tube requires octal socket and may be mounted in any position. Heater volts (ac/dc), 6.3;

**7355**

amperes, 0.8; peak heater-cathode volts, 200 (the dc component must not exceed 100 volts when the heater is positive with respect to the cathode).

**Class A<sub>1</sub> Amplifier**

**MAXIMUM RATINGS (Design-Maximum Values):**

Plate Voltage	500 max	volts
Grid-No.2 (Screen-Grid) Voltage	400 max	volts
Grid-No.1 (Control-Grid) Voltage, Positive-bias value	0 max	volts
Plate Dissipation	18 max	watts
DC Grid-No.2 Input	3.5* max	volts
Average Cathode Current	100 max	mA

**TYPICAL OPERATION AND CHARACTERISTICS:**

Plate Voltage	250	volts
Grid-No.2 Voltage	225	volts
Grid-No.1 Voltage	-15	volts
Peak AF Grid-No.1 Voltage	15	volts
Plate Resistance (Approx.)	*42000	ohms
Transconductance	7600	μmhos
Zero-Signal Plate Current	62	mA
Maximum Signal Plate Current	74	mA
Zero-Signal Grid-No.2 Current	3.2	mA
Maximum-Signal Grid-No.2 Current	16.5	mA
Load Resistance	2500	ohms
Total Harmonic Distortion (Approx.)	15	per cent
Maximum-Signal Power Output	9	watts
Grid-No.1 Voltage (Approx.) for plate current of 500 μA	-35	volts

**MAXIMUM CIRCUIT VALUES:**

Grid-No.1-Circuit Resistance:		
For fixed-bias operation	0.3 max	megohm
For cathode-bias operation	1 max	megohm

\* Grid-No.2 input may reach 7 watts during peak levels of speech and music signals.

**Push-Pull Class A<sub>1</sub> Amplifier**

**MAXIMUM RATINGS:**

(Same as for Class A<sub>1</sub> Amplifier)

**TYPICAL OPERATION (Values are for two tubes):**

Plate Voltage	300	400	volts
Grid-No.2 Voltage	250	300	volts
Grid-No.1 Voltage	-21	-34	volts
Peak AF Grid-No.1 Voltage	42	60	volts
Zero-Signal Plate Current	100	56	mA
Maximum-Signal Plate Current	185	175	mA
Zero-Signal Grid-No.2 Current	5.5	3.5	mA
Maximum-Signal Grid-No.2 Current	24	24	mA
Effective Load Resistance (Plate-to-plate)	4000	5000	ohms
Total Harmonic Distortion	2	6	per cent
Maximum-Signal Power Output	28.5	40	watts

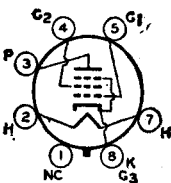

7AC

**BEAM POWER TUBE**

Glass octal type used as output amplifier tube in high-quality sound systems. Outline 13D, **Outlines** section. Tube requires octal socket and may be mounted in any position. Heater volts (ac/dc), 6.3; amperes, 0.45; peak

**7408**

heater-cathode volts, 200 (the dc component must not exceed 100 volts when the heater is positive with respect to the cathode).

**Class A, Amplifier**

**MAXIMUM RATINGS (Design-Maximum Values):**

Plate Voltage .....	350 max	volts
Grid-No.2 (Screen-Grid) Voltage .....	315 max	volts
Grid-No.2 Input .....	2.2 max	watts
Plate Dissipation .....	14 max	watts

**TYPICAL OPERATION AND CHARACTERISTICS:**

Plate Voltage .....	60	250	volts
Grid-No.2 Voltage .....	250	250	volts
Grid-No.1 (Control-Grid) Voltage .....	0	-12.5	volts
Peak AF Grid-No.1 Voltage .....	—	12.5	volts
Zero-Signal Plate Current .....	100*	45	mA
Maximum-Signal Plate Current .....	—	47	mA
Zero-Signal Grid-No.2 Current .....	22*	4.5	mA
Maximum-Signal Grid-No.2 Current .....	—	7	mA
Plate Resistance (Approx.) .....	—	50000	ohms
Transconductance .....	—	4100	μmhos
Load Resistance .....	—	5000	ohms
Total Harmonic Distortion .....	—	7	per cent
Maximum-Signal Power Output .....	—	4.5	watts

**MAXIMUM CIRCUIT VALUES:**

<b>Grid-No.1-Circuit Resistance:</b>	
For fixed-bias operation .....	0.1 max megohm
For cathode-bias operation .....	0.5 max megohm

\* This value can be measured by a method involving a recurrent waveform such that the maximum ratings of the tube will not be exceeded.

**SHARP-CUTOFF PENTODE**

**7543**

Miniature type used in compact audio equipment, especially in low-hum, low-microphonic, high-gain, resistance-coupled-amplifier applications. Outline 5C, **Outlines** section. This type is identical with miniature type 6AU6A

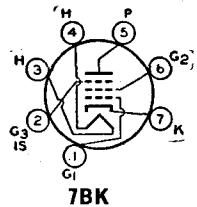

except that it has a controlled hum characteristic.

**HUM OUTPUT VOLTAGE:**

Average Value (rms, cathode bypassed) .....	1.2†	millivolts
Average Value (rms, cathode unbypassed) .....	0.9*	millivolt

† Measured in "true rms" units under the following conditions: heater volts (ac), 6.3; center tap of heater transformer connected to ground; plate and grid-No.2 supply volts, 250; plate load resistor, 0.27 megohm; grid No.3 and internal shield connected to cathode at socket; grid-No.2 resistor, 0.68 megohm; grid-No.1 resistor, 0.1 megohm; cathode resistor, 1000 ohms; grid resistor of following stage, 10 megohms; and stage gain, 340.

\* Same conditions as above except cathode resistor is unbypassed and stage gain is 110.

**POWER PENTODE**

**7591A**

Glass octal types used as audio-frequency power-output tube in high-quality audio applications. Outline 13D, **Outlines** section. Tubes require octal socket and may be mounted in any position. Heater volts (ac/dc), 6.3;

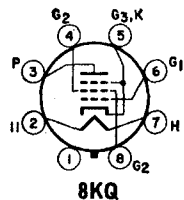

amperes, 0.8; peak heater-cathode volts, 200 (the dc component must not exceed 100 volts when the heater is positive with respect to the cathode).



**Class A<sub>1</sub> Amplifier**

**MAXIMUM RATINGS (Design-Maximum Values):**

Plate Voltage .....	550 max	volts
Grid-No.2 (Screen-Grid) Voltage .....	440 max	volts
Cathode Current .....	90 max	mA
Plate Dissipation .....	19 max	watts
Grid-No.2 Input .....	3.3*max	watts

**TYPICAL OPERATION AND CHARACTERISTICS:**

Plate Voltage .....	300	volts
Grid-No.2 Voltage .....	300	volts
Grid-No.1 (Control-Grid) Voltage .....	-10	volts
Peak AF Grid-No.1 Voltage .....	10	volts
Zero-Signal Plate Current .....	60	mA
Maximum-Signal Plate Current .....	75	mA
Zero-Signal Grid-No.2 Current .....	8	mA
Maximum-Signal Grid-No.2 Current .....	15	mA
Triode Amplification Factor* .....	16.8	
Plate Resistance (Approx.) .....	29000	ohms
Transconductance .....	10200	$\mu$ mhos
Load Resistance .....	3000	ohms
Total Harmonic Distortion .....	13	per cent
Maximum-Signal Power Output .....	11	watts

**MAXIMUM CIRCUIT VALUES:**

Grid-No.1-Circuit Resistance:	
For fixed-bias operation .....	0.3 max megohm
For cathode-bias operation .....	1 max megohm

\* Grid-No.2 input may reach 6 watts during peak levels of speech and music signals.

\* Triode connection, grid No.2 connected to plate.

**Push-Pull Class AB<sub>1</sub> Amplifier**

**MAXIMUM RATINGS:**

(Same as for Class A<sub>1</sub> Amplifier)

**TYPICAL OPERATION**

(Values are for two tubes):

	Fixed Bias		Cathode Bias		
Plate Supply Voltage .....					
Grid-No.2 Supply Voltage .....	350	450	450		volts
Grid-No.1 Supply Voltage .....	350	400	400		volts
Cathode-Bias Resistor .....	-15.5	-21	-		volts
(Common to both cathodes) .....	-	-	200		ohms
Peak AF Grid-No.1-to-Grid-No.1 Voltage .....	31	42	28		volts
Zero-Signal Plate Current .....	92	66	82		mA
Maximum-Signal Plate Current .....	130	144	94		mA
Zero-Signal Grid-No.2 Current .....	13	9.4	11.5		mA
Maximum-Signal Grid-No.2 Current .....	28.6	30	22		mA
Effective Load Resistance (Plate-to-plate) .....	6600	6600	9000		ohms
Total Harmonic Distortion .....	2	1.5	2		per cent
Maximum-Signal Power Output .....	30	45	28		watts

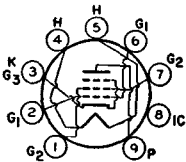

**9NZ**

**POWER PENTODE**

Novar type used in output stages of high-fidelity audio amplifiers or radio receivers; used in applications requiring relatively large power output. Outline 11C or 30D, **Outlines** section.

**7868**

Tube requires novar nine-contact

socket and may be operated in any position. It is especially important that this tube, like other power-handling tubes, be adequately ventilated.

Heater Voltage (ac/dc) .....	6.3	volts
Heater Current .....	0.8	ampere
Peak Heater-Cathode Voltage:		
Heater negative with respect to cathode .....	200 max	volts
Heater positive with respect to cathode .....	200□max	volts

**Direct Interelectrode Capacitances (Approx.):**

Grid No.1 to Plate .....	0.15	pF
Grid No.1 to Cathode, Heater, Grid No.2, and Grid No.3 .....	11	pF
Plate to Cathode, Heater, Grid No.2, and Grid No.3 .....	4.4	pF

▫ The dc component must not exceed 100 volts.

**Class A<sub>1</sub> Amplifier**

**MAXIMUM RATINGS (Design-Maximum System):**

Plate Voltage .....	550 max	volts
Grid-No.2 (Screen-Grid) Voltage .....	440 max	volts
Plate Dissipation .....	19 max	watts
Grid-No.2 Input .....	3.3 max	watts
DC Cathode Current .....	90 max	mA
Bulb Temperature (At hottest point) .....	240 max	°C

**AVERAGE CHARACTERISTICS**

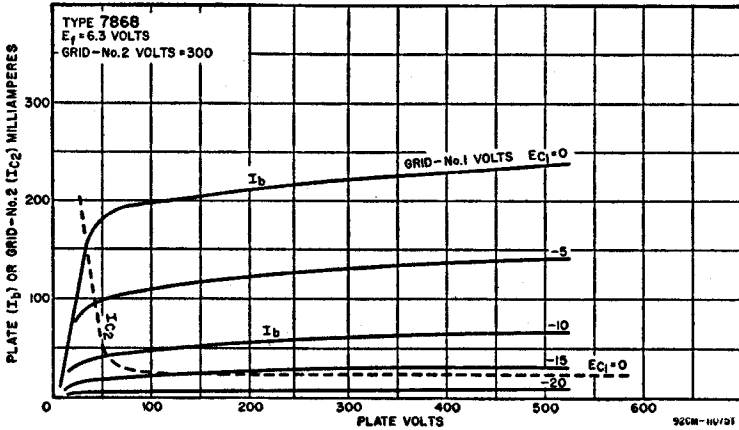

**TYPICAL OPERATION AND CHARACTERISTICS:**

Plate Supply Voltage .....	300	volts
Grid-No.2 Voltage .....	300	volts
Grid-No.1 (Control-Grid) Voltage .....	-10	volts
Peak AF Grid-No.1 Voltage .....	10	volts
Zero-Signal Plate Current .....	60	mA
Maximum-Signal Plate Current .....	75	mA
Zero-Signal Grid-No.2 Current .....	8	mA
Maximum-Signal Grid-No.2 Current .....	15	mA
Plate Resistance (Approx.) .....	29000	ohms
Transconductance .....	10200	μmhos
Effective Load Resistance .....	3000	ohms
Total Harmonic Distortion .....	13	per cent
Maximum-Signal Power Output .....	11	watts

**MAXIMUM CIRCUIT VALUES:**

**Grid-No.1-Circuit Resistance:**

For fixed-bias operation .....	0.3 max megohm
For cathode-bias operation .....	1 max megohm

• In push-pull circuits where the grid No.2 of each tube is connected to a tap on the plate winding of the output transformer, this maximum rating is 440 volts.

• Grid No.2 input may reach 6 watts during peak levels of speech and music signals.

**Push-Pull Class AB<sub>1</sub> Amplifier**

**MAXIMUM RATINGS:**

(Same as for Class A<sub>1</sub> Amplifier)

**TYPICAL OPERATION**

(Values are for two tubes):

	Fixed Bias				Cathode Bias	
Plate Supply Voltage .....	300	350	400	450	450	volts
Grid-No.2 Supply Voltage .....	300	350	350	350	400	volts
Grid-No.1 Voltage .....	-12.5	-15.5	-16	-16.5	-21	volts
Cathode-Bias Resistor (Common to both cathodes) .....	—	—	—	—	170	ohms
Peak AF Grid-No.1-to-Grid-No.1 Voltage .....	25	31	32	33	42	31 volts
Zero-Signal Plate Current .....	74	72	64	60	40	86 mA
Maximum-Signal Plate Current .....	116	130	135	142	145	94 mA
Zero-Signal Grid-No.2 Current .....	10	9.5	8	7.2	5	10 mA
Maximum-Signal Grid-No.2 Current .....	28	32	28	26	30	20 mA
Effective Load Resistance (Plate-to-plate) .....	6600	6600	6600	6600	6600	10000 ohms
Total Harmonic Distortion .....	5	2.5	2	2.5	5	2 per cent
Maximum-Signal Power Output .....	24	30	34	38	44	28 watts

**Push-Pull Class AB<sub>1</sub> Amplifier**

Grid No.2 of Each Tube Connected to Tap on Plate Winding of Output Transformer\*

**MAXIMUM RATINGS:**

(Same as for Class A<sub>1</sub> Amplifier)

**TYPICAL OPERATION** (Values are for two tubes):

	Fixed Bias	Cathode Bias	
Plate Supply Voltage .....	400	425	volts
Grid-No.2 Supply Voltage .....	*	*	volts
Grid-No.1 Voltage .....	-20.5	—	volts
Cathode-Bias Resistor (Common to both cathodes) .....	—	185	ohms
Peak AF Grid-No.1-to-Grid-No.1 Voltage .....	41	42	volts
Zero-Signal Plate Current .....	60	88	mA
Maximum-Signal Plate Current .....	115	100	mA
Zero-Signal Grid-No.2 Current .....	8	12	mA
Maximum-Signal Grid-No.2 Current .....	18	16	mA
Effective Load Resistance (Plate-to-plate) .....	6600	6600	ohms
Total Harmonic Distortion .....	2.5	3.5	per cent
Maximum-Signal Power Output .....	23	21	watts

\* Grid No.2 supply voltage is obtained from taps on the primary winding of the output transformer. The taps are located on each side of the center tap (B+) so as to apply 50 per cent of the plate signal voltage to the grid No.2 of each output tube.

# RCA Types for

(Types shown in light face are discontinued.)

RCA Type	Name	Out-line (see p. 513)	Basing Diagram (see p. 488)	Heater or Filament (F)		Use Values to right give operating conditions and characteristics for indicated typical use
				Volts	Amperes	
<b>OZ4</b>	Full-Wave Gas Rectifier	2A	4R	—	—	Rectifier
<b>OZ4G</b>	Full-Wave Gas Rectifier	29D	4R	—	—	Rectifier
<b>1A3</b>	Diode	5C	5AP	1.4	0.15	Rectifier
<b>1A4P</b>	Remote-Cutoff Pentode	24B	4M	2.0F	0.06	Class A Amplifier
<b>1A5GT</b>	Power Pentode	13D	6X	1.4F	0.05	Class A Amplifier
<b>1A6</b>	Pentagrid Converter	24B	6L	2.0F	0.06	Converter
<b>1A7GT</b>	Pentagrid Converter	14A	7Z	1.4F	0.05	Converter
<b>1AC5</b>	Power Pentode	29A	8CP	1.25F	0.04	Class A Amplifier
<b>1AD5</b>	Sharp-Cutoff Pentode	29A	8CP	1.25F	0.04	Class A Amplifier
<b>1AX2</b>	Half-Wave Rectifier	7A	9Y	1.4F	0.65	Pulsed Rectifier in TV Receivers
<b>1B3GT</b>	Half-Wave Rectifier	14E	3C	1.25F	0.2	Pulsed Rectifier in TV Receivers
<b>1B4P</b>	Sharp-Cutoff Pentode	24B	4M	2.0F	0.06	Class A Amplifier
<b>1B5/25S</b>	Twin Diode—Medium-Mu Triode	22 or 13H	6M	2.0F	0.06	Triode Unit as Class A Amplifier
<b>1B7GT</b>	Pentagrid Converter	14A	7Z	1.4F	0.10	Converter
<b>1C5GT</b>	Power Pentode	13D	6X	1.4F	0.10	Class A Amplifier
<b>1C6</b>	Pentagrid Converter	24B	6L	2.0F	0.12	Converter
<b>1C7G</b>	Pentagrid Converter	23	7Z	2.0F	0.12	Converter
<b>1D5GP</b>	Remote-Cutoff Pentode	23	5Y	2.0F	0.06	Class A Amplifier
<b>1D5GT</b>	Remote-Cutoff Tetrode	23	5R	2.0F	0.06	Class A Amplifier
<b>1D7G</b>	Pentagrid Converter	23	7Z	2.0F	0.06	Converter
<b>1D8GT</b>	Diode-Triode-Power Pentode	14A	8AJ	1.4F	0.10	Pentode Unit as Class A Amplifier Triode Unit as Class A Amplifier
<b>1DN5</b>	Diode—Semiremote-Cutoff Pentode	5C	6BW	1.4F	0.5	Pentode Unit as Class A Amplifier

# Replacement Use

Plate Supply Volts	Grid Bias or Cathode Resistor Volts (V) Ohms ( $\Omega$ )	Grid Supply Volts	Grid Current mA	Plate Current mA	AC Plate Resistance Ohms	Trans-conductance Micromhos	Amplification Factor	Load for Stated Power Output Ohms	Power Output Watts	RCA Type
Starting-Supply Voltage per Plate, 300 min. peak volts DC Output Current, 75 max., 30 min. mA						Peak Plate Current, 200 max. mA DC Output Voltage, 300 max. volts.			<b>0Z4</b>	
Starting-Supply Voltage per Plate, 300 min. peak volts DC Output Current, 75 max., 30 min. mA						Peak Plate Current, 200 max. mA DC Output Voltage, 300 max. volts.			<b>0Z4G</b>	
Max. Peak Plate Inverse Volts, 330 Max. Peak Plate mA, 5						Max. DC Output mA, 0.5 Max. Peak Heater-Cathode Volts, 140			<b>1A3</b>	
For other characteristics, refer to Type 1D5GP										<b>1A4P</b>
85	— 4.5V	85	0.7	3.5	300000	800	—	25000	0.100	<b>1A5GT</b>
90	— 4.5V	90	1.1	4.0	300000	850	—	25000	0.115	<b>1A5GT</b>
135	— 3V	67.5	2.5	1.2	400000	Anode-Grid (2): 180 max. volts 2.3 mA Oscillator-Grid (1) Resistor.				<b>1A6</b>
180	— 3V	67.5	2.4	1.3	500000					<b>1A6</b>
90	0V	45	0.7	0.6	600000	Anode-Grid (2): 90 volts, 1.2 mA Oscillator-Grid (1) Resistor, 0.2 M $\Omega$ Conversion Transcond., 250 micromhos				<b>1A7GT</b>
45	— 3V	45	0.2	1.0	170000	600	—	40000	0.015	<b>1A C5</b>
67.5	— 4.5V	67.5	0.4	2.0	150000	750	—	25000	0.050	<b>1A C5</b>
30	0V	30	0.16	0.45	700000	430	—	—	—	<b>1A D5</b>
67.5	0V	67.5	0.75	1.85	700000	735	—	—	—	<b>1A D5</b>
Max. Peak Inverse Plate Volts, 25000 Max. Peak Plate mA, 45						Max. Average Plate mA, 0.5			<b>1A X2</b>	
Max. Peak Inverse Plate Volts, 26000 Max. Peak Plate mA, 50						Max. Average Plate mA, 0.5			<b>1B3GT</b>	
For other characteristics, refer to Type 1E5GP										<b>1B4P</b>
For other characteristics, refer to Type 1H6G										<b>1B5/ 25S</b>
For other characteristics, refer to Type 1A7GT										<b>1B7GT</b>
90	— 7.5V	90	3.5	7.8	115000	1550	—	8000	0.24	<b>1C5GT</b>
For other characteristics, refer to Type 1C7G										<b>1C6</b>
135	— 3V	67.5	2.5	1.3	600000	Anode-Grid (2): 180 max. volts, 4.0 mA Oscillator-Grid (1) Resistor. Conversion Transcond., 325 micromhos.				<b>1C7G</b>
180	— 3V	67.5	2.0	1.5	700000					<b>1C7G</b>
90	{ — 3V min. }	67.5	0.9	2.2	600000	720	—	—	—	<b>1D5GP</b>
180		67.5	0.8	2.3	1 M $\Omega$	750	—	—	—	<b>1D5GP</b>
For other characteristics, refer to Type 1D5GP										<b>1D5GT</b>
For other characteristics, refer to Type 1A6										<b>1D7G</b>
90	— 9V	90	1.0	5.0	—	925	—	12000	0.200	<b>1D8GT</b>
90	0V	—	—	1.1	43500	575	25	—	—	<b>1D8GT</b>
67.5	0V	67.5	0.55	2.1	600000	630	—	—	—	<b>1D N5</b>

RCA Type	Name	Out-line (see p. 513)	Basing Diagram (see p. 488)	Heater or Filament (F)		Use Values to right give operating conditions and characteristics for indicated typical use
				Unless specified all types have heaters. Ⓢ Heater with controlled warmup time.		
				Volts	Amperes	
1E5GP	Sharp-Cutoff Pentode	23	5Y	2.0F	0.06	Class A Amplifier
1E7GT	Twin Power Pentode	13D	8C	2.0F	0.24	Class A Amplifier
1E8	Pentagrid Converter	29A	8CN	1.25F	0.04	Converter
1F4	Power Pentode	26	5K	2.0F	0.12	Class A Amplifier
1F5G	Power Amplifier Pentode	25	6X	2.0F	0.12	Class A Amplifier
1F6	Twin Diode—Sharp-Cutoff Pentode	23	6W	2.0F	0.06	Pentode Unit as Class A Amplifier
1F7G	Twin Diode—Sharp-Cutoff Pentode	23	7AF	2.0F	0.06	Pentode Unit as Class A Amplifier
1G4GT	Medium-Mu Triode	13D	5S	1.4F	0.05	Class A Amplifier
1G5G	Power Pentode	25	6X	2.0F	0.12	Class A Amplifier
1G6GT	High-Mu Twin Power Triode	13D	7AB	1.4F	0.10	Class B Amplifier
1H4G	Medium-Mu Triode	22	5S	2.0F	0.06	Class A Amplifier Class B Amplifier
1H5GT	Diode—High-Mu Triode	14A	5Z	1.4F	0.05	Triode Unit as Class A Amplifier
1H6G	Twin Diode—Medium-Mu Triode	22	7AA	2.0F	0.06	Triode Unit as Class A Amplifier
1J3	Half-Wave Rectifier	14E	3C	1.25F	0.2	Pulsed Rectifier in TV Receivers
1J5G	Power Pentode	25	6X	2.0F	0.12	Class A Amplifier
1J6G	Twin-Triode Amplifiers	22	7AB	2.0F	0.24	Class B Amplifier
1J6GT		13F				
1K3	Half-Wave Rectifier	14B	3C	1.25F	0.2	Pulsed Rectifier in TV Receivers
1L6	Pentagrid Converter	5C	7DC	1.4F	0.05	Converter
1LA4	Power Pentode	12B	5AD	1.4F	0.05	Amplifier
1LA6	Pentagrid Converter	12B	7AK	1.4F	0.05	Converter
1LB4	Power Pentode	12B	5AD	1.4F	0.05	Class A Amplifier
1LC5	Sharp-Cutoff Pentode	12B	7AO	1.4F	0.05	Class A Amplifier
1LC6	Pentagrid Converter	12B	7AK	1.4F	0.05	Converter
1LD5	Diode—Sharp-Cutoff Pentode	12B	6AX	1.4F	0.05	Pentode Unit as Class A Amplifier
1LE3	Medium-Mu Triode	12B	4AA	1.4F	0.05	Class A Amplifier
1LG5	Remote-Cutoff Pentode	12B	7AO	1.4F	0.05	Class A Amplifier
1LN4	Diode—High-Mu Triode	12B	5AG	1.4F	0.05	Triode Unit as Class A Amplifier
1LN5	Sharp-Cutoff Pentode	12B	7AO	1.4F	0.05	Class A Amplifier
1N2A	Half-Wave Rectifier	19A	3C	1.25F	0.2	Pulsed Rectifier in TV Receivers
1N5GT	Sharp-Cutoff Pentode	14A	5Y	1.4F	0.05	Class A Amplifier
1N6G	Diode—Power Pentode	29A	7AM	1.4F	0.05	Pentode Unit as Class A Amplifier

Types shown in light face are discontinued.

Plate Supply Volts	Grid Bias Volts (V) or Cathode Resistor Ohms (Ω)	Grid Supply Volts	Grid Current mA	Plate Current mA	AC Plate Resistance Ohms	Trans-conductance Micromhos	Amplification Factor	Load for Stated Power Output Ohms	Power Output Watts	RCA Type
90	— 3V	67.5	0.7	1.6	1 MΩ	600	—	—	—	1E5GP
180	— 3V	67.5	0.6	1.7	1.5 MΩ	650	—	—	—	1E5GP
135	— 7.5V	135	3.5	10.5	—	—	—	24000	0.575	1E7GT
45	0V	45	1.1	0.6	400000	Oscillator Grid (1)	Resistor, 0.1 MΩ	—	—	1E8
67.5	0V	67.5	1.5	1.0	400000	Conversion Transcond.,	150 micromhos	—	—	1E8
For other characteristics, refer to Type 1F5G										1F4
90	— 3V	90	1.1	4.0	240000	1400	—	20000	0.11	1F5G
135	— 4.5V	135	2.4	8.0	—	—	—	—	0.31	1F5G
For other characteristics, refer to Type 1F7G										1F6
180	— 1.5V	67.5	0.7	2.2	—	—	—	—	—	1F7G
90	— 6V	—	—	2.3	10700	825	8.8	—	—	1G4GT
90	— 6V	90	2.5	8.5	133000	1500	—	8500	0.25	1G5G
135	— 13.5V	135	2.5	9.7	160000	1550	—	9000	0.55	1G5G
90	0V	—	11	—	—	—	—	12000	0.350	1G6GT
180	— 13.5V	—	—	3.1	10300	900	9.3	—	—	1H4G
157.5	— 15V	—	—	1.0□	—	—	—	8000	2.1†	1H4G
90	0V	—	—	0.15	240000	275	65	—	—	1H5GT
135	— 3V	—	—	0.8	35000	575	20	—	—	1H6G
Max. Peak Inverse Plate Volts, 26000 (Abs.)					Max. Average Plate mA, 0.5					1J3
Max. Peak Plate mA, 50										
135	— 18.5V	135	2.0	7.0	105000	950	—	13500	0.45	1J5G
135	0V	—	—	Power Output is for one tube at stated plate-to-plate load				10000	2.1	1J6G
135	— 3V	—	—					10000	1.9	1J6GT
Max. Peak Inverse Plate Volts, 26000 (Abs.)					Max. Average Plate mA, 0.5					1K3
Max. Peak Plate mA, 50										
90	0V	45	0.6	0.5	650000	Anode-Grid (2): 90 max. volts, 1.2 mA Oscillator Grid (1) Resistor, 0.2 MΩ Conversion Transcond, 300 micromhos		—	—	1L6
For other characteristics, refer to Type 1A5GT										1LA4
90	0V	65	0.6	0.55	750000	Total Cathode mA, 4 Conversion Transcond. (for grid-No. 4 bias of —3 volts), 10 micromhos		—	—	1LA6
For other characteristics, refer to Pentode Unit of Type 1D8GT										1LB4
45	0V	45	0.35	1.10	700000	750	—	—	—	1LC5
90	0V	45	0.30	1.15	1 MΩ	775	—	—	—	1LC5
45	0V	35	0.75	0.70	300000	Anode-Grid (2): 50 max. volts, 1.4 mA Oscillator-Grid (1) Resistor, 0.2 MΩ Conversion Transcond., 275 micromhos		—	—	1LC6
90	0V	35	0.70	0.75	650000			—	—	1LC6
90	0V	45	0.1	0.6	750000	575	—	—	—	1LD5
90	0V	—	—	4.5	11200	1300	14.5	—	—	1LE3
90	— 3V	—	—	1.4	19000	760	14.5	—	—	1LE3
90	0V	45	0.4	1.7	1 MΩ	800	—	—	—	1LG5
90	— 1.5V	90	0.9	3.7	500000	1150	—	—	—	1LG5
For other characteristics, refer to Type 1H5GT										1LH4
90	0V	90	0.35	1.6	1.1 MΩ	800	—	—	—	1LN5
Max. Peak Inverse Plate Volts (Total DC and Peak), 28000					Max. Average Plate mA, 0.5					1N2A
Max. Peak Plate mA, 50										
90	0V	90	0.3	1.2	1.5 MΩ	750	—	—	—	1N5GT
90	— 4.5V	90	0.6	3.1	300000	800	—	25000	0.1	1N6G

† For two tubes at stated plate-to-plate load.

□ For two tubes.

RCA Type	Name	Out-line (see p. 513)	Basing Diagram (see p. 488)	Heater or Filament (F)		Use Values to right give operating conditions and characteristics for indicated typical use
				Unless specified all types have heaters. ⊕ Heater with controlled warmup time.		
				Volts	Amperes	
1P5GT	Remote-Cutoff Pentode	14A	5Y	1.4F	0.05	Class A Amplifier
1Q5GT	Beam Power Tube	13D	6AF	1.4F	0.1	Class A Amplifier
1R5	Pentagrid Converter	5C	7AT	1.4F	0.05	Converter
1S4	Power Pentode	5C	7AV	1.4F	0.1	Class A Amplifier
1S5	Diode—Sharp-Cutoff Pentode	5C	6AU	1.4F	0.05	Pentode Unit as AF Amplifier
1T4	Remote-Cutoff Pentode	5C	6AR	1.4F	0.05	Class A Amplifier
1T5GT	Beam Power Tube	13D	6X	1.4F	0.05	Class A Amplifier
1T6	Diode—Sharp-Cutoff Pentode	29A	8DA	1.25F	0.04	Pentode Unit as Class A Amplifier
1U4	Sharp-Cutoff Pentode	5C	6AR	1.4F	0.05	Class A Amplifier
1U5	Diode—Sharp-Cutoff Pentode	5C	6BW	1.4F	0.05	Pentode Unit as Class A Amplifier
1V	Half-Wave Rectifier	22 or 13H	4G	6.3	0.3	With Capacitive-Input Filter
1X2A	Half-Wave Rectifier	7A	9Y	1.25F	0.2	Pulsed Rectifier in TV Receivers
2A3	Power Triode	27B	4B	2.5F	2.5	Class A Amplifier Push-Pull Class AB <sub>1</sub> Amplifier
2A5	Power Pentode	28	6B	2.5	1.75	Amplifier
2A6	Twin Diode—High-Mu Triode	24B	6G	2.5	0.8	Triode Unit as Amplifier
2A7	Pentagrid Converter	24B	7C	2.5	0.8	Converter
2AF4A	Medium-Mu Triode	5B	7DK	2.35⊕	0.6	Class A Amplifier
2B7	Twin Diode—Remote-Cutoff Pentode	24B	7D	2.5	0.8	Pentode Unit as Amplifier
2BN4	Medium-Mu Triode	5C	7EG	2.3⊕	0.6	Class A Amplifier
2E5	Electron-Ray Tube	22 or 13H	6R	2.5	0.8	Visual Indicator
2EN5	Twin Diode	5C	7FL	2.1⊕	0.45	Horizontal Phase Detector
3A2	Half-Wave Rectifier	7A	9DT	3.15	0.22	Pulsed Rectifier in TV Receivers
3A3	Half-Wave Rectifier	14E	8EZ	3.15	0.22	Pulsed Rectifier in TV Receivers
3A8GT	Diode-Triode—Pentode	29G	8AS	1.4F 2.8F	0.1 0.05	Triode Unit as Class A Amplifier Pentode Unit as Class A Amplifier
3B2	Half-Wave Rectifier	21C	8GH	3.15	0.22	Pulsed Rectifier in TV Service
3BN4	Medium-Mu Triode	5C	7EG	3.0⊕	0.45	Class A Amplifier
3DT6	Sharp-Cutoff Pentode	5C	7EN	3.15⊕	0.6	Class A Amplifier
3GS8/ 3BU8	Sharp-Cutoff Twin Pentode	8E	9LW	3.15⊕	0.6	Class A Amplifier (With both sections operating)
3LF4	Beam Power Tube	12B	6BA	1.4F 2.8F	0.1 0.05	Class A Amplifier
3Q4	Power Pentode	5C	7BA	1.4F 2.8F	0.1 0.05	Class A Amplifier
3Q5GT	Beam Power Tube	13D	7AP	1.4F 2.8F	0.1 0.05	Class A Amplifier
3S4	Power Pentode	5C	7BA	1.4F 2.8F	0.1 0.05	Class A Amplifier
3V4	Power Pentode	5C	6BX	1.4F 2.8F	0.1 0.05	Class A Amplifier



Plate Supply Volts	Grid Bias or Cathode Resistor Volts (V) or Ohms ( $\Omega$ )	Grid Supply Volts	Grid Current mA	Plate Current mA	AC Plate Resistance Ohms	Trans-conductance Micromhos	Amplification Factor	Load for Stated Power Output Ohms	Power Output Watts	RCA Type
90	0V	90	0.7	2.3	800000	750	—	—	—	1P5GT
110	— 6.6V	110	1.4	10	100000	2200	—	8000	0.4	1Q5GT
45	0V	45	2.1	0.7	500000	—	—	—	—	1R5
90	0V	67.5	3.5	1.5	400000	—	—	—	—	
45	— 4.5V	45	0.8	3.8	100000	1250	—	8000	0.065	1S4
90	— 7V	67.5	1.4	7.4	100000	1575	—	8000	0.27	
Plate Supply, 90 V applied through 1 M $\Omega$ resistor. Screen Supply, 90 V applied through 3.1 M $\Omega$ resistor. Grid Bias, 0 volts. Grid Resistor, 10 megohms. Voltage Gain, 66 approx.										1S5
45	0V	45	0.7	1.7	350000	700	—	—	—	1T4
90	0V	67.5	1.4	3.5	500000	900	—	—	—	1T5GT
90	— 6V	90	0.8	6.5	250000	1150	—	14000	0.17	1T5GT
45	0V	45	0.21	0.75	500000	475	—	—	—	1T6
67.5	0V	67.5	0.4	1.6	400000	600	—	—	—	1T6
90	0V	90	0.50	1.1	1 M $\Omega$	900	—	—	—	1U4
67.5	0V	67.5	0.4	1.6	600000	625	—	—	—	1U5
Max. AC Plate Volts (RMS), 325 Max. DC Output mA, 45				Min. Total Effective Plate-Supply Impedance: Up to 117 volts, 0 ohms; at 150 volts, 30 ohms; at 325 volts, 75 ohms						1V
Max. Peak Inverse Plate Volts, 20000 Max. Peak Plate mA, 45				Max. Average Plate mA, 0.5						1X2A
250	—45V	—	—	60.0	800	5250	4.2	2500	3.5	2A3
300	780 $\Omega$ □	—	—	80.0□	—	—	—	5000	10.0†	
300	—62V	—	—	80.0□	—	—	—	3000	15.0†	
For other characteristics, refer to Type 6F6G										2A5
For other characteristics, refer to Type 6SQ7										2A6
For other characteristics, refer to Type 6A8										2A7
80	150 $\Omega$	—	—	17.5	2100	6500	13.5	—	—	2AF4A
For other characteristics, refer to Type 6B8G										2B7
150	220 $\Omega$	—	—	9	6300	6800	43	—	—	2BN4
For other characteristics, refer to Type 6E5										2E5
{Max. Peak Heater-Cathode Volts, $\pm$ 200 DC Volts Not to Exceed +100						Max. DC Plate mA, 5			2EN5	
Max. Peak Inverse Plate Volts, 18000 Max. Peak Plate mA, 80				Max. Average Plate mA, 1.5						3A2
Max. Peak Inverse Plate Volts, 30000 Max. Peak Plate mA, 88				Max. Average Plate mA, 1.7						3A3
90	0V	—	—	0.2	200000	325	65	—	—	3A8GT
90	0V	90	0.5	1.5	800000	750	—	—	—	
Max. Peak Plate mA, 80 Max. Total DC & Peak Inverse Plate Volts, 35000 (Abs.)				Max. DC Inverse Plate Volts, 25000 Max. Average Plate mA, 1.1						3B2
For other characteristics, refer to Type 6BN4										3BN4
150	56 $\Omega$	100	2.1	1.1	150000	515	—	—	—	3DT6
For other characteristics, refer to Type 4GS8/4BU8										3GS8/ 3BU8
For other characteristics, refer to Type 3Q5GT										3LF4
For other characteristics, refer to Type 3V4										3Q4
110	— 6.6V	110	1.4	10.0	100000	2200	—	8000	0.40	3Q5GT
110	— 6.6V	110	1.1	8.5	110000	2000	—	8000	0.33	
90	— 7V	67.5	1.4	7.4	100000	1575	—	8000	0.27	3S4
90	— 7V	67.5	1.1	6.1	100000	1425	—	8000	0.235	
90	— 4.5V	90	2.1	9.5	100000	2150	—	10000	0.27	3V4
90	— 4.5V	90	1.7	7.7	120000	2000	—	10000	0.24	

RCA Type	Name	Out-line (see p. 513)	Basing Diagram (see p. 488)	Heater or Filament (F)		Use Values to right give operating conditions and characteristics for indicated typical use
				Unless specified all types have heaters.		
				⊕ Heater with controlled warmup time.		
				Volts	Amperes	
4BC5	Sharp-Cutoff Pentode	5C	7BD	4.2⊕	0.45	Class A Amplifier
4DT6	Sharp-Cutoff Pentode	5C	7EN	4.2⊕	0.45	Class A Amplifier
4GS8	Sharp-Cutoff Pentode	6E	9LW	4.2⊕	0.45	Class A Amplifier
4GS8/ 4BU6	Sharp-Cutoff Twin Pentode	6E	9LW	4.2⊕	0.45	Class A Amplifier (With both sections operating)
5AS4	Full-Wave Rectifier	27A	5T	5.0F	3.0	With Capacitive-Input Filter
5AU4	Full-Wave Rectifier	19G	5T	5.0F	3.75	With Capacitive-Input Filter
						With Inductive-Input Filter
5AW4	Full-Wave Rectifier	19H	5T	5.0F	3.7	Rectifier
5AZ4	Full-Wave Rectifier	12C	5T	5.0F	2.0	
5BE8	Medium-Mu Triode—Sharp-Cutoff Pentode	6B	9EG	4.7⊕	0.6	Triode Unit as Class A Amplifier
						Pentode Unit as Class A Amplifier
5BT8	Twin-Diode—Sharp-Cutoff Pentode	6B	9FE	4.7⊕	0.6	Class A Amplifier
5CL8	Medium-Mu Triode—	6B	9FX	4.7⊕	0.6	Triode Unit as Class A Amplifier
5CM8	High-Mu Triode—Sharp-Cutoff Pentode	6B	9FZ	6.3⊕	0.45	Triode Unit as Class A Amplifier
						Pentode Unit as Class A Amplifier
5DH8	High-Mu Triode—Sharp-Cutoff Pentode	6B	9EG	5.2⊕	0.6	Triode Unit as Class A Amplifier
						Pentode Unit as Class A Amplifier
5T4	Full-Wave Rectifier	4	5T	5.0F	2.0	With Capacitive-Input Filter
						With Inductive-Input Filter
5U4G	Full-Wave Rectifier	27B	5T	5.0F	3.0	With Capacitive-Input Filter
5V3	Full-Wave Rectifier	19E	5T	5.0F	3.8	With Capacitive-Input Filter
						With Inductive Input Filter
5W4	Full-Wave Rectifier	2B	5T	5.0F	1.5	With Capacitive-Input Filter
5W4GT		13E	5T			
5X4G	Full-Wave Rectifier	27B	5Q	5.0F	3.0	
5Y3G	Full-Wave Rectifier	25	5T	5.0F	2.0	With Capacitive-Input Filter
5Y4G	Full-Wave Rectifier	25	5Q	5.0F	2.0	
5Y4GA		19E	5Q			
5Y4GT		13E	5Q			
5Z3	Full-Wave Rectifier	27B	4C	5.0F	3.0	
5Z4	Full-Wave Rectifier	2B	5L	5.0	2.0	With Capacitive-Input Filter
						With Inductive-Input Filter
6A3	Power Triode	27B	4D	6.3F	1.0	Amplifier
6A6	High-Mu Twin Power Triode	2B	7B	6.3	0.8	Amplifier

Plate Supply Volts	Grid Bias Volts (V) or Cathode Resistor Ohms ( $\Omega$ )	Grid Supply Volts	Grid Current mA	Plate Current mA	AC Plate Resistance Ohms	Trans-conductance Micromhos	Amplification Factor	Load for Stated Power Output Ohms	Power Output Watts	RCA Type
250	180 $\Omega$	150	2.1	7.5	800000	5700	—	—	—	4BC5
150	56 $\Omega$	100	2.1	1.1	150000	515	—	—	—	4DT6
For other characteristics, refer to Type 4GS8/4BU8										4GS8
100	:	67.5	6.0	—	Grid-No. 3 volts, each section, —10					4GS8/ 4BU8
100	:	67.5	3.6	2.0	Grid-No. 3 volts, each section, 0					
: Grid current adjusted for 100 microamperes DC										5AS4
Max. AC Volts per Plate (RMS), 550					Max. DC Output mA, 300		Min. Total Effect. Supply Imped. per Plate, 150 ohms			5AU4
Max. Peak Inverse Volts, 1550					Max. Peak Plate mA, 1000		Max. Peak Inverse Volts, 1400			
Max. DC Output mA, 325 for AC Volts per Plate, 400					Max. Peak Plate mA per Plate, 1075					5AW4
and Total Effect. Supply Imped. per Plate, 50 ohms					Max. Peak Inverse Volts, 1400					
Max. DC Output mA, 325 for AC Volts per Plate, 500 and Input Choke 10 henries					Max. Peak Plate mA per Plate, 1075					5AZ4
Max. Peak Inverse Volts, 1400					Max. Peak Plate mA per Plate, 750					
For ratings and characteristics, refer to Type 5Y3GT										5BE8
150	56 $\Omega$	—	—	18	5000	8500	40	—	—	5BT8
250	68 $\Omega$	110	3.5	10	400000	5200	—	—	—	5CL8
200	180 $\Omega$	150	2.8	9.5	300000	6200	—	—	—	5CM8
125	— 1V	—	—	14	5000	8000	40	—	—	5DH8
For other characteristics, refer to 6CM8										5DT4
250	390 $\Omega$	—	—	7.3	12000	4400	53	—	—	5U4G
125	56 $\Omega$	125	3.8	13.5	150000	8600	—	—	—	5V3
Max. AC Volts per Plate (RMS), 450					Max. DC Output mA, 225		Min. Total Effect. Supply Imped. per Plate, 150 ohms			5W4 5W4GT
Max. Peak Inverse Volts, 1550					Max. Peak Plate mA, 675		Min. Value of Input Choke, 10 henries			
Max. AC Volts per Plate (RMS), 550					Max. DC Output mA, 225		Min. Total Effect. Supply Imped. per Plate, 170 ohms			5Y3G
Max. Peak Inverse Volts, 1550					Max. Peak Plate mA, 675		Min. Value of Input Choke, 10 henries			
Max. AC Volts per Plate (RMS), 450					Max. DC Output mA, 225		Min. Total Effect. Supply Imped. per Plate, 1200			5Z3
Max. Peak Inverse Volts, 1550					Max. Peak Plate mA, 675		Min. Total Effect. Supply Imped. per Plate, 56 ohms			
Max. AC Volts per Plate (RMS), 425					Max. DC Output mA, 350		Min. Total Effect. Supply Imped. per Plate, 1200			5Y4G 5Y4GA 5Y4GT
Max. Peak Inverse Volts, 1400					Max. Peak Plate mA, 675		Min. Total Effect. Supply Imped. per Plate, 1200			
Max. AC Volts per Plate (RMS), 500					Max. DC Output mA, 350		Min. Total Effect. Supply Imped. per Plate, 1200			5Z3
Max. Peak Inverse Volts, 1400					Max. Peak Plate mA, 100		Min. Value of Input Choke, 10 henries			
Max. Peak Inverse Volts, 1400					Max. DC Output mA, 100		Max. Peak Plate mA, 300			5X4G
For other ratings, refer to Type 5U4G										5Y3G
Max. AC Volts per Plate (RMS), 350					Max. DC Output mA, 125		Min. Total Effect. Supply Imped. per Plate, 50 ohms			5Y4G 5Y4GA 5Y4GT
Max. Peak Inverse Volts, 1400					Max. Peak Plate mA, 440		Min. Total Effect. Supply Imped. per Plate, 50 ohms			
Max. Peak Plate mA, 375 (5Y4G)					For other ratings, refer to Type 5Y3G					5Z3
Max. Peak Plate mA, 400 (5Y4GA, 5Y4GT)					For other ratings, refer to Type 5U4G					5Z4
Max. AC Volts per Plate (RMS), 350					Max. DC Output mA, 125		Min. Total Effect. Supply Imped. per Plate, 50 ohms			6A3
Max. Peak Inverse Volts, 1400					Max. Peak Plate mA, 375		Min. Total Effect. Supply Imped. per Plate, 50 ohms			
Max. AC Volts per Plate (RMS), 500					Max. DC Output mA, 125		Min. Value of Input Choke, 5 henries			6A6
Max. Peak Inverse Volts, 1400					Max. Peak Plate mA, 375		Min. Value of Input Choke, 5 henries			
For other characteristics, refer to Type 6B4G										6A6
For other characteristics, refer to Type 6N7GT										6A6

RCA Type	Name	Out-line (see p. 513)	Basing Diagram (see p. 488)	Heater or Filament (F)		Use Values to right give operating conditions and characteristics for indicated typical use
				Unless specified all types have heaters. ⊖ Heater with controlled warmup time.		
				Volts	Amperes	
6A7 6A7S	Pentagrid Converter	24B 24B	7C	6.3	0.3	Converter
6A8 6A8G 6A8GT	Pentagrid Converter	3 23 14A	8A 8A 8A	6.3	0.3	Converter
6AB5/ 6N5	Electron-Ray Tube	22 or 13H	6R	6.3	0.15	Visual Indicator
6AB7	Sharp-Cutoff Pentode	2A	8N	6.3	0.45	Class A Amplifier Class B Amplifier
6AC5GT	High-Mu Power Triode	13D	6Q	6.3	0.4	Dynamic-Coupled Amplifier With 76 Driver
6AC7	Sharp-Cutoff Pentode	2A	8N	6.3	0.45	Class A Amplifier
6AD6G	Electron-Ray Tube	29E	7AG	6.3	0.15	Visual Indicator
6AD7G	Low-Mu Triode—Power Pentode	25	8AY	6.3	0.85	Triode Unit as Class A Amplifier Pentode Unit as Class A Amplifier
6AE5GT	Low-Mu Triode	13D	8Q	6.3	0.3	Class A Amplifier
6AEGG	Twin-Plate Control Tube	22	7AH	6.3	0.15	Remote Cutoff Triode Sharp-Cutoff Triode
6AE7GT	Twin-Input Triode	13D	7AX	6.3	0.5	Class A Amp.
6AH4GT	Low-Mu Triode	13D	8EL	6.3	0.75	Vertical Deflection Amplifier
6AH6	Sharp-Cutoff Pentode	5C	7BK	6.3	0.45	Class A Amplifier
6AL7GT	Electron-Ray Tube	13C	8CH	6.3	0.15	Visual Indicator
6AM4	High-Mu Triode	6A	9BX	6.3	0.225	Class A Amplifier
6AM8	Diode—Sharp-Cutoff Pentode	6B	9CY	6.3 6.3⊖	0.45 0.45	Diode Unit Pentode Unit as Class A Amplifier
6AN8	Medium-Mu Triode—Sharp-Cutoff Pentode	6B	9DA	6.3 6.3⊖	0.45 0.45	Triode Unit as Class A Amplifier Pentode Unit as Class A Amplifier
6AQ5	Beam Power Tube	5D	7BZ	6.3 6.3⊖	0.45 0.45	Single Tube Class A Amplifier Push-Pull Class A <sub>2</sub> Amplifier
6AQ6	Twin-Diode—High-Mu Triode	5C	7BT	6.3	0.15	Triode Unit as Class A Amplifier
6AQ7GT	Twin-Diode—High-Mu Triode	13D	8CK	6.3	0.3	Triode Unit as Class A Amplifier
6AR5	Power Pentode	5D	6CC	6.3	0.4	Class A Amplifier
6AS11	Dual Triode—Sharp-Cutoff Pentode	8B	12DP	6.3	1.05	Dual Triode Unit as Class A Amplifier Pentode Unit as Class A Amplifier
6AT8	Medium-Mu Triode—	6B	9DW	6.3	0.45	Triode Unit as Class A Amplifier
6AU4GT	Half-Wave Rectifier	13G	4CG	6.3	1.8	Television Damper Service
6AU6	Sharp-Cutoff Pentode	5C	7BK	6.3 6.3⊖	0.3 0.3	Class A Amplifier

Plate Supply Volts	Grid Bias Volts (V) or Cathode Resistor Ohms (Ω)	Grid Supply Volts	Grid Current mA	Plate Current mA	AC Plate Resistance Ohms	Trans-conductance Micromhos	Amplification Factor	Load for Stated Power Output Ohms	Power Output Watts	RCA Type
For other characteristics, refer to Type 6A8										6A7 6A7S
250	— 3V	100	2.7	3.5	360000	Anode-Grid (2): 250 Oscillator-Grid (1) Res. 550 Transcond., 550 μmhos	250	max. V, 4.0 Res. Conversion	4.0 mA	6A8 6A8G 6A8GT
Plate & Target Supply = 135 volts. Triode Plate Resistor = 0.25 MΩ Target Current = 2.0 mA Grid Bias, — 10.0 volts; Shadow Angle, 0°. Bias, 0 volts; Angle, 90°; Plate Current, 0.5 mA.										6AB5/ 6N5
Plate & Target Supply = 135 volts. Triode Plate Resistor = 1.0 MΩ Target Current = 1.9 mA Grid Bias, — 15.5 volts; Shadow Angle, 0°. Bias, 0 volts; Angle, 90°; Plate Current, 0.13 mA										
300	— 3V	200	3.2	12.5	700000	5000	—	—	—	6AB7
250	0V	—	—	5.0□	—	—	—	10000	8.0†	6AC5GT
250	Bias for both 6AC5GT and 76 is developed in coupling circuit Average Plate Current of Driver = 5.5 milliamperes Average Plate Current of 6AC5GT = 32 milliamperes								7000	
300	160Ω	150	2.5	10.0	1.0	9000	—	—	—	6AC7
Target Voltage, 150 volts. Control-Electrode Voltage, —50 volts; Shadow Angle, 135°; Target Current, 1.2 mA Control-Electrode Voltage, 75 volts; Angle, 0°; Target Current, 3 mA										6AD6G
250	—25V	—	—	3.7	19000	325	6	—	—	6AD7G
250	—16.5V	250	6.5	34.0	80000	2500	—	7000	3.2	
95	—15V	—	—	7.0	3500	1200	4.2	—	—	6AE5GT
250	— 1.5V	—	—	6.5	25000	1000	25	—	—	6AE6G
250	—35V	—	—	0.01	—	—	—	—	—	
250	— 1.5V	—	—	4.5	35000	950	33	—	—	6AE7GT
250	— 9.5V	—	—	0.01	—	—	—	—	—	
250	—13.5V	—	—	10.0	4650	3000	14	—	—	6AE7GT
Max. DC Plate Volts, 500 Max. DC Cathodes mA, 60					Max. Peak Positive-Pulse Plate Volts, 2000 Max. Plate Dissipation, 7.5 watts					6AH4GT
300	160Ω	150	2.5	10.0	500000	9000	—	—	—	6AH6
Target Voltage, 315 volts Grid Voltage = 0 volts Cathode Bias Res., 3300 ohms approx.					Grid Voltage for Pattern Cutoff, —7 volts approx. Deflecting-Electrodes—No. 1, No. 2 and No. 3 Voltage, 0					6AL7GT
200	100Ω	—	—	10	8700	9800	85	—	—	6AM4
Max. DC Plate mA, 5      Max. Peak Heater-Cathode Volts, ±200										6AM8
125	56Ω	125	3.2	12.5	—	7800	—	—	—	
150	— 3V	—	—	15	4500	4700	31	—	—	6AN8
125	56Ω	125	3.8	12	170000	7800	—	—	—	
180	— 8.5V	180	3.0	29.0	50000	3700	—	5500	2.0	6AQ5
250	—12.5V	250	4.5	45.0	50000	4100	—	5000	4.5	
250	—15V	250	5.0□	70.0□	60000	—	—	10000	10.0†	6AQ6
100	— 1V	—	—	0.8	61000	1150	70	—	—	
250	— 3V	—	—	1.0	58000	1200	70	—	—	
250	— 2V	—	—	2.3	44000	1600	70	—	—	6AQ7GT
250	—18V	250	5.5	32.0	90000	2300	—	7600	3.4	6AR5
200	220Ω	—	—	9.2	4400	4400	41	—	—	6AS11
200	— 2V	—	—	7	12400	5500	68	—	—	
200	125	125	5.2	24	70000	10500	—	—	—	6AT8
125	— 1V	—	—	12	6000	6500	40	—	—	
Max. Peak Inverse Plate Volts, 4500 (Absolute) Max. Peak Plate mA, 1050					Max. Average Plate mA, 175 Max. Plate Dissipation 6.0 watts					6AU4GT
100	150Ω	100	2.1	5.0	500000	3900	—	—	—	6AU6
250	68Ω	150	4.3	10.6	1.0	5200	—	—	—	

† For two tubes at stated plate-to-plate load.

□ For two tubes.

RCA Type	Name	Out-line (see p. 513)	Basing Diagram (see p. 488)	Heater or Filament (F)		Use Values to right give operating conditions and characteristics for indicated typical use
				Unless specified all types have heaters. ☉ Heater with controlled warmup time.		
				Volts	Amperes	
6AU7	Medium-Mu Twin Triode	8B	9A	3.15 6.3	0.6 0.3	Each Unit as Class A Amplifier
6AU8	Medium-Mu Triode—Sharp-Cutoff Pentode	6E	9DX	6.3☉	0.6	Triode Unit as Class A Amplifier Pentode Unit as Class A Amplifier
6AV5GT	Beam Power Tube	13D	6CK	6.3	1.2	Horizontal Deflection Amplifier
6AW8	High-Mu Triode—Sharp-Cutoff Pentode	6E	9DX	6.3☉	0.6	Triode Unit as Class A Amplifier Pentode Unit as Class A Amplifier
6AX4GT	Half-Wave Rectifier	13D	4CG	6.3	1.2	Television Damper Service
6AX8	Medium-Mu Triode—Semiremote Cutoff Pentode	6B	9AE	6.3	0.45	Triode Unit as Class A Amplifier Pentode Unit as Class A Amplifier
6AY11	Twin Diode—High-Mu Twin Triode	8A	12DA	6.3	0.69	Each Triode Unit as Class A Amplifier
6B4G	Power-Triode	27B	5S	6.3F	1.0	Class A Amplifier
6B5	Direct-Coupled Power Triode	26	6AS	6.3	0.8	Class A Amplifier
6B6G	Twin-Diode—High-Mu Triode	23	7V	6.3	0.3	Triode Unit as Amplifier
6B7	Twin-Diode—Remote-Cutoff Pentode	24B	7D	6.3	0.3	Pentode Unit as Amplifier
6B7S						
6B8	Twin-Diode—Semiremote-Cutoff Pentode	3	8E	6.3	0.3	Pentode Unit as Amplifier
6B8G	Twin Diode—Semiremote-Cutoff Pentode	23	8E	6.3	0.3	Pentode Unit as Class A Amplifier
6BD4	Sharp-Cutoff Beam Triode	21C	8FU	6.3	0.6	Voltage-Control
6BD4A	Sharp-Cutoff Beam Triode	21C	8FU	6.3	0.6	Voltage-Control
6BD6	Remote-Cutoff Pentode	5C	7BK	6.3	0.3	Class A Amplifier
6BF5	Beam Power Tube	5D	7BZ	6.3	1.2	Class A Amplifier
6BF6	Twin-Diode—Medium-Mu Triode	5C	7BT	6.3	0.3	Triode Unit as Class A Amplifier
6BG6G	Beam Power Tube	28B	5BT	6.3	0.9	Horizontal Deflection Amplifier
6BG6GA		21B	5BT			
6BK4	Sharp-Cutoff Beam Triode	21B	8GC	6.3	0.2	Voltage-Control
6BK5	Beam Power Tube	6E	9BQ	6.3	1.2	Class A Amplifier
6BK7A	Medium-Mu Twin Triodes	6B	9AJ	6.3 6.3☉	0.45 0.45	Each Unit as Class A Amplifier
6BL4	Half-Wave Rectifier	13F	8GB	6.3	3.0	Television Damper Service
6BL7GT	Medium-Mu Twin Triode	13D	8BD	6.3	1.5	Vertical Deflection Amplifier
6BN4	Medium-Mu Triode	5C	7EG	6.3	0.2	Class A Amplifier
6BQ6GT	Beam Power Tube	14D	6AM	6.3	1.2	Horizontal Deflection Amplifier
6BQ7	Medium-Mu Twin Triode	6B	9AJ	6.3	0.4	Each Unit as Class A Amplifier
6BR8	Medium-Mu Triode—Sharp-Cutoff Pentode	6B	9FA	6.3 6.3☉	0.45 0.45	Triode Unit as Class A Amplifier Pentode Unit as Class A Amplifier
6BV8	Twin Diode—Medium-Mu Triode	6B	9FJ	6.3☉	0.6	Triode Unit as Class A Amplifier

Types shown in light face are discontinued.

Plate Supply Volts	Grid Bias Volts (V) or Cathode Resistor Ohms (Ω)	Grid Supply Volts	Grid Current mA	Plate Current mA	AC Plate Resistance Ohms	Trans-conductance Micromhos	Amplification Factor	Load for Stated Power Output Ohms	Power Output Watts	RCA Type
100	0V	—	—	11.8	6250	3500	19.5	—	—	6AU7
250	— 8.5V	—	—	10.5	7700	2200	17	—	—	
150	150Ω	—	—	9	8200	4900	40	—	—	
200	82Ω	125	3.4	15	150000	7000	—	—	—	6AU8
Max. DC Plate Volts, 550					Max. Peak Positive-Pulse Plate Volts, 5500 (Abs.)					6AV5GT
Max. DC Cathode mA, 110					Max. Plate Dissipation, 11 watts					
200	— 2V	—	—	4	—	4000	70	—	—	6AW8
150	150Ω	150	3.5	13	200000	9500	—	—	—	
6AW8A Features a plate current characteristic with a controlled knee										
Max. Peak Inverse Plate Volts, 4400					Max. Peak Heater-Cathode Volts: { -4400**					6AX4GT
Max. Peak Plate mA, 750					+300					
Max. DC Plate mA, 125					**DC component must not exceed 900 volts					
150	560Ω	—	—	18	5000	8500	40	—	—	6AX8
250	120Ω	110	3.5	10	400000	4800	—	—	—	
250	— 2V	—	—	1.2	52700	1900	100	—	—	6AY11
250	—45V	—	—	60	800	5250	4.2	2500	3.5	6B4G
For other characteristics, refer to Type 6N6G										6B5
For other characteristics, refer to Type 6SQ7										6B6G
Input Triode:	Plate Volts, 300 max; Grid Volts, 0; Plate mA, 8; AF Signal Volts (Peak), 21									6B7
Output Triode:	Plate Volts, 300 max.; Plate mA, 45; Plate Res., 24000 ohms; Load Resistance, 7000 ohms; Power Output, 4 watts									6B7S
For other characteristics, refer to Type 12C8										6B8
250	— 3V	125	2.3	9	600000	1125	—	—	—	6B8G
Max. DC Plate Volts, 20000					Max. DC Plate mA, 1.5					6BD4
Max. Unregulated DC Supply Volts, 40000					Max. Plate Dissipation, 20.0 watts					
Max. DC Plate Volts, 27000					Max. DC Plate mA, 1.5					6BD4A
Max. Unregulated DC Supply Volts, 55000					Max. Plate Dissipation, 25.0 watts					
250	— 3V	100	3.0	9.0	800000	2000	—	—	—	6BD6
110	— 7.5V	110	4.0	36.0	12000	7500	—	2500	1.9	6BF5
250	— 9V	—	—	9.5	8500	1900	16	Power Output, 300 milliwatts		6BF6
Max. DC Plate Volts, 700					Max. Peak Positive-Pulse Plate Volts, 6600 (Abs.)					6BG6G
Max. DC Cathode mA, 110					Max. Plate Dissipation, 20 watts					
Max. DC Plate Volts, 27000					Max. DC Plate mA, 1.6					6BK4
Max. Unregulated DC Supply Volts, 60000					Max. Plate Dissipation, 25 Watts					
250	— 5V	250	3.5	35	100000	8500	—	6500	3.5	6BK5
150	56Ω	—	—	18	4600	9300	43	Grid-No. 1 Volts for Cutoff, -11		6BK7A
Max. Peak Inverse Plate Volts, 4500 (Abs.)					Max. Peak Heater-Cathode Volts: { -4500* (Abs.)					6BL4
Max. Peak Plate mA, 1200					+300					
Max. DC Plate mA, 200					*DC component not to exceed -900 volts					
Max. DC Plate Volts, 500					Max. Peak Positive-Pulse Plate Volts, 2000 (Abs.)					6BL7GT
Max. DC Cathode mA. (Each Unit), 60					Max. Plate Dissipation (Each Unit), 10 watts					
150	220Ω	—	—	9	6300	6800	43	—	—	6BN4
Max. DC Plate Volts, 550					Max. Peak Positive-Pulse Plate Volts, 5500 (Abs.)					6BQ6GT
Max. DC Cathode mA, 110					Max. Plate Dissipation, 11 watts					
150	220Ω	—	—	9.0	5800	6000	35	Grid-No. 1 Volts for Cutoff, -10		6BQ7
125	— 1V	—	—	13.5	7500	—	40	—	—	6BR8
125	— 1V	110	3.5	9.5	200000	5000	—	—	—	
200	330Ω	—	—	11	5900	5600	33	—	—	6BV8

† For two tubes at stated plate-to-plate load.

RCA Type	Name	Out-line (see p. 513)	Basing Diagram (see p. 488)	Heater or Filament (F)		Use Values to right give operating conditions and characteristics for indicated typical use
				Unless specified all types have heaters. Ⓞ Heater with controlled warmup time.		
				Volts	Amperes	
6BW4	Full-Wave Rectifier	6E	9DJ	6.3	0.9	With Capacitive Input Filter
						With Inductive Input Filter
6BX7GT	Medium-Mu Twin Triode	13D	8BD	6.3	1.5	Vertical Deflection Oscillator
						Vertical Deflection Amplifier
6BY5GA	Full-Wave Rectifier	18B	6CN	6.3	1.6	Television Damper Service
6BZ8	Medium-Mu Twin Triode	6B	9AJ	6.3	0.4	Each Unit as Class A Amplifier
6C5	Medium-Mu Triode	2A	6Q	6.3	0.3	Class A Amplifier
6C5GT		14A	6Q			
6C6	Sharp-Cutoff Pentode	24A	6F	6.3	0.3	Amplifier Detector
6C7	Twin-Diode—Medium-Mu Triode	24B	7G	6.3	0.3	Triode Unit as Class A Amplifier
6C8G	Medium-Mu Twin-Triode	23	8G	6.3	0.3	Each Unit as Class A Amplifier
6CB5	Beam Power Tube	28A	8GD	6.3	2.5	Horizontal Deflection Amplifier
6CD6G	Beam Power Tube	28B	5BT	6.3	2.5	Horizontal Deflection Amplifier
6CG8	Medium-Mu Triode—Sharp-Cutoff Pentode	6B	9GF	6.3	0.45	Triode Unit as Class A Amplifier
				6.3Ⓞ	0.45	Pentode Unit as Class A Amplifier
6CH8	Medium-Mu Triode—Sharp-Cutoff Pentode	6B	9FT	6.3	0.45	Triode Unit as Class A Amplifier
						Pentode Unit as Class A Amplifier
6CK4	Low-Mu Triode	13F	8JB	6.3	1.25	Vertical Deflection Amplifier
6CL8	Medium-Mu Triode—Sharp-Cutoff Tetrode	6B	9FX	6.3Ⓞ	0.45	Triode Unit as Class A Amplifier
						Tetrode Unit as Class A Amplifier
6CM8	High-Mu Triode—Sharp-Cutoff Pentode	6B	9FZ	6.3Ⓞ	0.45	Triode Unit as Class A Amplifier
						Pentode Unit as Class A Amplifier
6D6	Remote-Cutoff Pentode	24A	6F	6.3	0.3	Amplifier Mixer
6D7	Sharp-Cutoff Pentode	24A	7H	6.3	0.3	Amplifier Detector
6D8G	Pentagrid Converter	23	8A	6.3	0.15	Converter
6DC8	Twin Diode—Remote-Cutoff Pentode	6E	9HE	6.3	0.3	Class A Amplifier
6DM4	Half-Wave Rectifier	13G	4CG	6.3	1.2	Damper Service
6DN6	Beam Power Tube	21B	5BT	6.3	2.5	Horizontal Deflection Amplifier
6DQ4	Half-Wave Rectifier	13F	4CG	6.3	1.2	Damper Service
6DQ6A	Beam Power Tube	2B	6AM	6.3	1.2	Horizontal Deflection Amplifier
6DT6	Sharp-Cutoff Pentode	5C	7EN	6.3	0.3	Class A Amplifier
6DW5	Beam Power Tube	6G	9CK	6.3	1.2	Vertical Deflection Amplifier
6DZ7	Twin Power Pentode	19B	8IP	6.3	1.52	Class A Amplifier
						Both Units as Push-Pull Class AB <sub>1</sub> Amplifier
6E6	Twin Power Amplifier	26	7B	6.3	0.6	Push-Pull Class A Amplifier
6E7	Remote-Cutoff Pentode	24A	7H	6.3	0.3	Amplifier



Plate Supply Volts	Grid Bias or Cathode Resistor Ohms (Ω)	Grid Supply Volts	Grid Current mA	Plate Current mA	AC Plate Resistance Ohms	Trans-conductance Micromhos	Amplification Factor	Load for Stated Power Output Ohms	Power Output Watts	RCA Type	
Max. AC Volts per Plate (RMS), 325					Max. DC Output mA, 62.5					6B74	
Max. Peak Inverse Volts, 1275					Max. Peak Plate mA, per Plate, 350						
Total Effect. Supply Imped. per Plate, 82 ohms											
Max. AC Volts per Plate (RMS), 450					Max. DC Output mA, 62.5					6B76T	
Max. Peak Inverse Volts, 1275					Max. Peak Plate mA per Plate, 350						
Min. Value of Input Choke, 10 henries											
Max. DC Plate Volts, 500					Max. DC Cathode mA, 180					6B78	
Max. Plate Dissipation: 10 watts either plate; 12 watts both plates											
Max. DC Plate Volts, 500					Max. Peak Positive-Pulse Plate Volts, 2000 (Abs.)					6B95GA	
Max. DC Cath. mA, 180					Max. Plate Dissipation: 10 watts either plate; 12 watts both plates						
Max. Peak Inverse Plate Volts, 3000 (Abs.)					Max. Peak Heater-Cathode Volts: $\begin{cases} -450 \\ +100 \end{cases}$						
Max. Peak Plate mA, 525											
Max. DC Plate mA, 175											
125	100Ω	—	—	10	5600	8000	45	—	—	6BZ8	
250	— 8V	—	—	8.0	10000	2000	20	—	—	6C5 6C5GT	
For other characteristics, refer to Type 6J7											
250	— 9V	—	—	4.5	16000	1250	20	—	—	6C6	
250	— 4.5V	—	—	3.2	22500	1600	36	—	—	6C7	
Max. DC Plate Volts, 700					Max. Peak Positive-Pulse Plate Volts, 6800 (Abs.)					6C8G	
Max. DC Cathode mA, 200					Max. Plate Dissipation, 23 Watts						
Max. DC Plate Volts, 700					Max. Peak Positive-Pulse Plate Volts, 7000					6C8B	
Max. DC Cathode mA, 200					Max. Plate Dissipation, 20 watts						
100	— 1V	—	—	12	6000	6500	40	—	—	6C8G	
250	— 1V	125	2.2	9	300000	5500	—	—	—	6C8H	
200	— 6V	—	—	13	5750	3300	19	—	—	6C8H	
200	180Ω	150	2.8	9.5	300000	6200	—	—	—	6C8H	
Max. DC Plate Volts, 550					Max. Peak Positive-Pulse Plate Volts, 2000 (Abs.)					6C8K4	
Max. Peak Cathode mA, 350					Max. Plate Dissipation, 12 watts						
125	— 1V	—	—	14	5000	8000	40	—	—	6C8L8	
125	— 1V	125	4	12	120000	6000	—	—	—	6C8L8	
250	— 2V	—	—	1.8	50000	2000	100	—	—	6C8M8	
250	180Ω	150	2.8	9.5	600000	6200	—	—	—	6C8M8	
For other characteristics, refer to Type 6U6											
For other characteristics, refer to Type 6J7											
250	— 3V	100	2.7	3.5	360000	Anode-Grid (2): 250 max. volts, 4 mA Oscillator-Grid (1) Resistor. Conversion Transcond., 550 micromhos.				6D8G	
250	—2V	100	2.7	9	1	3800	—	—	—	6DC8	
Max. Peak Inverse Plate Volts, 5000					Max. Peak Plate mA, 1100			Max. DC Plate mA, 175			6DM4
Max. Peak Heater-Cathode Volts, -5000 (DC Component Not to Exceed 900 Volts)					Max. Peak Positive-Pulse Plate Volts, 6600 (Abs.)			Max. Plate Dissipation, 15 watts			
Max. Peak Heater-Cathode Volts, +300 (DC Component Not to Exceed 100 Volts)					Max. DC Plate mA, 175			Max. Plate Dissipation, 6 watts			
Max. DC Plate Volts, 700					Max. DC Cathode mA, 200			Max. DC Plate mA, 175			6DQ4
Max. DC Cathode mA, 200					Max. Plate Dissipation, 6 watts			Max. Plate Dissipation, 6 watts			
Max. Peak Inverse Volts, 5500					Max. DC Plate Volts, 770			Max. Peak Positive-Pulse Plate Volts, 6000 (Abs.)			6DQ6A
Max. Peak Plate mA, 1000					Max. DC Cathode mA, 155			Max. Plate Dissipation, 18 watts			
150	560Ω	100	2.1	1.1	150000	515	—	—	—	6DT6	
Max. DC Plate Volts, 330					Max. DC Cathode mA, 65			Max. Peak Positive-Pulse Plate Volts, 2200			6DW5
Max. DC Cathode mA, 65					Max. Plate Dissipation, 11 watts			Max. Plate Dissipation, 11 watts			
250	— 7.3V	250	5.5	48	38000	11300	—	—	—	6DZ7	
400	—11V	250	13	100	—	—	—	9000	18	6DZ7	
300	120Ω	250	15	80	—	—	—	9000	12		
250	—27.5V	—	—	—	—	—	—	14000	1.60†	6E6	
For other characteristics, refer to Type 6U6G											
6E7											

RCA Type	Name	Out-line (see p. 513)	Basing Diagram (see p. 488)	Heater or Filament (F) Unless specified all types have heaters. $\oplus$ Heater with controlled warmup time.		Use Values to right give operating conditions and characteristics for indicated typical use
				Volts	Amperes	
<b>6EH8</b>	Medium-Mu Triode—Sharp-Cutoff Pentode	<b>6B</b>	<b>9JG</b>	6.3 $\oplus$	0.45	Triode Unit as Class A Amplifier Pentode Unit as Class A Amplifier
<b>6EV7</b>	High-Mu Twin Triode	<b>6E</b>	<b>9LP</b>	6.3	0.6	Relay Control
<b>6EX6</b>	Beam Power Tube	<b>21B</b>	<b>5BT</b>	6.3 $\oplus$	2.25	Horizontal Deflection Amplifier
<b>6EY6</b>	Beam Power Tube	<b>13F</b>	<b>7AC</b>	6.3 $\oplus$	0.68	Vertical Deflection Amplifier
<b>6EZ5</b>	Beam Power Tube	<b>13F</b>	<b>7AC</b>	6.3	0.8	Vertical Deflection Amplifier
<b>6F5</b> <b>6F5GT</b>	High-Mu Triode	<b>3</b> <b>14A</b>	<b>5M</b> <b>5M</b>	6.3	0.3	Class A Amplifier
<b>6F6G</b> <b>6F6GT</b>	Power Pentode	<b>25</b> <b>13F</b>	<b>7S</b> <b>7S</b> <b>7S</b>	6.3	0.7	Pentode Class A Amplifier Triode $\square$ Class A Amplifier Pentode Push-Pull Class A Amplifier
<b>6F7</b>	Low-Mu Triode—Remote-Cutoff Pentode	<b>24B</b>	<b>7E</b>	6.3	0.3	Triode Unit as Class A Amplifier Pentode Unit as Class A Amplifier
<b>6F8G</b>	Medium-Mu Twin Triode	<b>23</b>	<b>8G</b>	6.3	0.6	Each Unit as Class A Amplifier
<b>6FE5</b>	Beam Power Tube	<b>13G</b>	<b>8KB</b>	6.3	1.2	Class A Amplifier
<b>6FQ7</b>	Medium-Mu Twin Triode	<b>6E</b>	<b>9LP</b>	6.3 $\oplus$	0.6	Each Unit as Class A Amplifier
<b>6FV8</b>	Medium-Mu Triode—Sharp-Cutoff Pentode	<b>6B</b>	<b>9FA</b>	6.3 $\oplus$	0.45	Triode Unit as Class A Amplifier Pentode Unit as Class A Amplifier
<b>6FW8</b>	Medium-Mu Twin Triode	<b>6B</b>	<b>9AJ</b>	6.3	0.4	Each Unit as Class A Amplifier
<b>6G6G</b>	Power Pentode	<b>22</b>	<b>7S</b>	6.3	0.15	Pentode Class A Amplifier
<b>6G11</b>	Beam Power Tube—Sharp-Cutoff Pentode	<b>8B</b>	<b>12BU</b>	6.3	1.2	Beam Power Unit as Class A Amplifier Pentode Unit as Class A Amplifier
<b>6GH8</b>	Medium-Mu Triode—Sharp-Cutoff Pentode	<b>6B</b>	<b>9AE</b>	6.3 $\oplus$	0.45	Triode Unit as Horiz. Defl. Osc. Pentode Unit as Horiz. Defl. Osc.
<b>6GJ5</b>	Novar Beam Power Tube	<b>18A</b>	<b>9QK</b>	6.3	1.2	Horizontal Deflection Amplifier
<b>6GJ8</b>	Medium-Mu Triode—Sharp-Cutoff Pentode	<b>6B</b>	<b>9AE</b>	6.3 $\oplus$	0.6	Triode Unit as Class A Amplifier Pentode Unit as Class A Amplifier
<b>6GY8</b>	Triple High-Mu Triode	<b>6B</b>	<b>9LY</b>	6.3	0.45	Each Unit as Class A Amplifier
<b>6H6GT</b>	Twin Diode	<b>13D</b>	<b>7Q</b> <b>7Q</b>	6.3	0.3	Voltage Doubler Half-Wave Rectifier
<b>6J5</b> <b>6J5GT</b>	Medium-Mu Triode	<b>2A</b> <b>13D</b>	<b>6Q</b> <b>6Q</b>	6.3	0.3	Class A Amplifier
<b>6J6</b>	Medium-Mu Twin Triode	<b>5C</b>	<b>7BF</b>	6.3 6.3 $\oplus$	0.45 0.45	Each Unit as Class A Amplifier Push-Pull Class C Amplifier
<b>6J7</b> <b>6J7G</b> <b>6J7GT</b>	Sharp-Cutoff Pentode	<b>3</b> <b>23</b> <b>14A</b>	<b>7R</b> <b>7R</b> <b>7R</b>	6.3	0.3	Pentode Class A RF Amplifier

 $\square$  For two tubes.

Types shown in light face are discontinued.

Plate Supply Volts	Grid Bias Volts (V) or Cathode Resistor Ohms (Ω)	Grid Supply Volts	Grid Current mA	Plate Current mA	AC Plate Resistance Ohms	Trans-conductance Micromhos	Amplification Factor	Load for Stated Power Output Ohms	Power Output Watts	RCA Type
125	-1V	—	—	13.5	—	7500	40	—	—	6EH8
125	-1V	125	4	12	170000	6000	—	—	—	
250	0V	—	—	18.5	—	Grid Volts for Plate $\mu$ A 100 =	—	—	—	6EV7
150	0V	—	—	10.0	—	Grid Volts for Plate $\mu$ A 100 =	—	—	2500-ohm relay	
175	-30V	175	3.3	67	8500	7700	—	—	—	6EX6
250	-17.5V	250	3	44	60000	4400	—	—	—	6EY6
250	-20V	250	3.5	43	50000	4100	—	—	—	6EZ5
100	-1V	—	—	0.4	85000	1150	100	—	—	6F5
250	-2V	—	—	0.9	66000	1500	100	—	—	6F5GT
250	-16.5V	250	6.5	34.0	80000	2500	—	7000	3.2	6F6G
285	-20V	285	7.0	38.0	78000	2550	—	7000	4.8	
250	-20V	—	—	31.0	2600	2600	6.8	4000	0.85	6F6GT
315	-24V	285	12.0□	62.0□	—	—	—	10000	11.0†	
100	-3V	—	—	3.5	16000	500	8	—	—	6F7
250	-3V	100	1.5	6.5	850000	1100	—	—	—	
For other characteristics, refer to Type 6J5										6F8G
145	-16V	145	18	100	8000	9500	—	1000	5.6	6FE5
250	-8V	—	—	9	7700	2600	20	—	—	6FQ7
125	-1V	—	—	14	5000	8000	40	—	—	6FV8
125	-1V	125	4	12	200000	6500	—	—	—	
100	1.2V	—	—	15	2500	13000	33	—	—	6FW8
180	-9V	180	2.5	15.0	175000	2300	—	10000	1.1	6GG6
120	-8V	110	4	49	10000	7500	—	2500	2.3	6G11
150	150Ω	150	3.5	15	20000	9500	—	—	—	
Max. DC Plate Volts, 330					Max. Plate Dissipation, 2.5 watts					6GH8
Max. DC Plate Volts, 350					Max. Peak Cathode mA, 300					
Max. Peak Neg.-Pulse Grid Volts, 175					Max. DC Cathode mA, 20					Max. Plate Dissipation, 2.5 watts
250	-22.5V	150	2.1	70	15000	7100	—	—	—	6GJ5
125	-1V	—	—	13.5	5000	8500	40	—	—	6GJ8
125	-1V	125	4.5	12	150000	7500	—	—	—	
125	-1V	—	—	4.5	14000	4500	63	—	—	6GY8
Max. AC Supply Volts per Plate (RMS), 150					Max. DC Output mA, 8. min.					6H6GT
Min. Total Effect. Plate-Supply Imped. per Plate					Min. Total Effective Plate-Supply Impedance: up to 117 volts, 15 ohms; at 150 volts, 40 ohms					
Max. AC Plate Volts (RMS), 150										
Max. DC Output mA, 8 per Plate										
90	0V	—	—	10	6700	3000	20	—	—	6J5
250	-8V	—	—	9	7700	2600	20	—	—	6J5GT
100	50Ω (For both units)	—	—	8.5	7100	5300	38	—	—	6J6
150	-10V	—	—	30	Grid Current, 16 mA Driving Power, 0.35 watt		—	—	3.5	
100	-3V	100	0.5	2.0	1.0	1185	—	—	—	6J7
250	-3V	100	0.5	2.0	1.0	1225	—	—	—	6J7G
										6J7GT

† For two tubes at stated plate-to-plate load.

RCA Type	Name	Out-line (see p. 513)	Basing Diagram (see p. 488)	Heater or Filament (F)		Use Values to right give operating conditions and characteristics for indicated typical use
				Unless specified all types have heaters. ☉ Heater with controlled warmup time.		
				Volts	Amperes	
6J8G	Triode-Heptode Converter	23	8H	6.3	0.3	Triode Unit as Oscillator
						Heptode Unit as Mixer
6JE6	Beam Power Tube	18B	9QL	6.3	2.5	Horizontal Deflection Amplifier
6JG6	Beam Power Tube	17B	9QU	6.3	1.6	Horizontal Deflection Amplifier
6K5GT	High-Mu Triode	14A	5U	6.3	0.3	Class A Amplifier
6K7	Remote-Cutoff Pentode	3	7R	6.3	0.3	Class A Amplifier
6K7G		23	7R			
6K7GT		14A	7R			
6K8	Triode-Hexode Converter	3	8K	6.3	0.3	Triode Unit as Oscillator
6K8G		23	8K			Hexode Unit as Mixer
6K8GT		—	8K			
6K11	Twin High-Mu Triode— Medium-Mu Triode	8A	12BY	6.3☉	0.6	Twin Unit as Class A Amplifier Class A Amplifier
6KL8	Diode—Sharp-Cutoff Pentode	6E	9LQ	6.3	0.3	Pentode Unit as Class A Amplifier
6L5G	Medium-Mu Triode	22	6Q	6.3	0.15	Class A Amplifier
6L6G	Beam Power Tube	27B 19D	7AC	6.3	0.9	Single-Tube Class A Amplifier
6L6GB			7AC 7AC 7AC			Push-Pull Class A Amplifier
						Push-Pull Class AB <sub>1</sub> Amplifier
6L7	Pentagrid Mixer □	3	7T	6.3	0.3	Mixer Service
6L7G		23	7T			
6N6G	Direct-Coupled Power Triode	25	7AU	6.3	0.8	Class A Amplifier
6N7	Medium-Mu Twin Power Triode	2B	8B	6.3	0.8	Class A Amplifier (as Driver)
6N7GT		13D	8B			Class B Amplifier
6P5GT	Medium-Mu Triode	13D	6Q	6.3	0.3	Amplifier Detector
6P7G	Low-Mu Triode—Remote-Cutoff Pentode	23	7U	6.3	0.3	Amplifier and Converter
6Q7	Twin Diode High-Mu Triode	3	7V	6.3	0.3	Triode Unit as Class A Amplifier
6Q7G		23	7V			
6Q7GT		14A	7V			
6Q11	Twin High-Mu Triode— Medium-Mu Triode	8A	12BY	6.3☉	0.6	Twin Unit as Class A Amplifier Class A Amplifier
6R7	Twin Diode—Medium-Mu Triode	3	7V	6.3	0.3	Triode Unit as Class A Amplifier
6R7G		23	7V			
6R7GT		14A	7V			
6S4	Medium-Mu Triode	8E	9AC	6.3 6.3☉	0.6 0.6	Vertical Deflection Amplifier
6S7	Remote-Cutoff Pentode	3	7R	6.3	0.15	Class A Amplifier
6S7G		23	7R			
6S8GT	Triode Diode—High-Mu Triode	14C	8CB	6.3	0.3	Triode Unit as Class A Amplifier
6SA7GT	Pentagrid Converter	13D	8R 8AD	6.3	0.3	Mixer
6SB7Y	Pentagrid Converter	2A	8R	6.3	0.3	Mixer
6SC7	High-Mu Twin Triode	2A	8S	6.3	0.3	Each Unit as Amplifier
6SF5	High-Mu Triode	2A	8AB	6.3	0.3	Class A Amplifier
6SF5GT		13D	8AB			

□ For two tubes.

Types shown in light face are discontinued.

Plate Supply Volts	Grid Bias Volts (V) or Cathode Resistor Ohms ( $\Omega$ )	Grid Supply Volts	Grid Current mA	Plate Current mA	AC Plate Resistance Ohms	Trans-conductance Micromhos	Amplification Factor	Load for Stated Power Output Ohms	Power Output Watts	RCA Type	
100 250	Triode-Grid Resistor, 50000 ohms			4 5	— —	— —	— —	— —	— —	6J8G	
For other characteristics, refer to Type 6JE6A											
6JE6											
For other characteristics, refer to Type 6JG6A											
6JG6											
250	— 3V	100	2.8	1.4	1.5	Conversion Transcond., 290 micromhos					
250	— 3V	—	—	1.1	50000	1400	70	—	—	6K5GT	
250	— 3V	125	2.6	10.5	600000	1650	—	—	—	6K7 6K7G 6K7GT	
100	Grid Res., 50000 ohms			3.8	Triode-Grid & Hexode-Grid Current, 0.15 mA					6K8	
100 250	— 3V — 3V	100 100	6.2 6.0	2.3 2.5	400000 600000	Conversion Transcond., 325 micromhos Conversion Transcond., 350 micromhos				6K8G 6K8GT	
250	— 2V	—	—	1.2	62500	1600	100	—	—		
250	— 8.5V	—	—	10.5	7700	2200	17	—	—	6K11	
100	0	100	2.2	5.5	555000	4300	Grid-No. 1 Volts for plate current of 10 $\mu$ A, 4.2			6KL8	
250	— 9V	—	—	8.0	9000	1900	17	—	—	6L5G	
250	— 14V	250	5.0	72.0	—	—	—	2500	6.5		
250	168 $\Omega$	250	5.4	75.0	—	—	—	2500	6.5		
270	— 17.5V	270	11.0 $\square$	134.0 $\square$	—	—	—	5000	17.5 $\dagger$	6L6G	
270	124 $\Omega$ $\square$	270	11.0 $\square$	134.0 $\square$	—	—	—	5000	18.5 $\dagger$	6L6GB	
360	— 22.5V	270	5.0 $\square$	88.0 $\square$	—	—	—	6600	26.5 $\dagger$		
360	248 $\Omega$ $\square$	270	5.0 $\square$	88.0 $\square$	—	—	—	9000	24.5 $\dagger$		
250	— 6V	150	9.2	2.3	Oscillator-Grid (No. 3) Bias, —15 volts Grid-No. 3 Peak Swing, 16 volts minimum Conversion Transcond., 350 micromhos					6L7 6L7G	
Output Triode: Plate Volts, 300; Plate mA, 45; Load, 7000 ohms Triode: Plate Volts, 300; Grid Volts, 0; Input Plate mA, 8									4.0	6N6G	
250	— 5V	—	—	6.0	11300	3100	35	20000	exceeds	6N7	
300	— 6V	—	—	7.0	11000	3200	35	or more	0.4	6N7GT	
300	0V	Power Output for 1 tube at stated plate-to-plate load							8000	10.0	
For other characteristics, refer to Type 76											
6P5GT											
For other characteristics, refer to Type 6F7											
6P7G											
100 250	— 1V — 3V	— —	— —	0.8 1.1	58000 58000	1200 1200	70 70	— —	— —	6Q7 6Q7G 6Q7GT	
250	— 2V	—	—	1.2	62500	1600	100	—	—		
150	0V	—	—	22	7000	2500	18	—	—	6Q11	
250	— 9V	—	—	9.5	8500	1900	16	—	—	6R7 6R7G 6R7GT	
Max. DC Plate Volts, 550 Max. DC Cathode mA, 30					Max. Peak Positive-Pulse Plate Volts, 2200 Max. Plate Dissipation, 8.5 watts					6S4	
250	— 3V	100	2.0	8.5	1.0	1750	—	—	—	6S7 6S7G	
250	— 2V	—	—	0.9	91000	1100	100	—	—	6S8GT	
250	Self-Excited	100	8.5	3.5	1.0	Grid-No. 1 Resistor, 20000 ohms. Conversion Transcond., 450 micromhos				6SA7GT	
100	— 1V	100	10.2	3.6	500000	Grid-No. 1 Resistor, 20000 ohms. Conversion Transcond., 950 micromhos				6SB7Y	
250	— 2V	—	—	2.0	53000	1325	70	—	—	6SC7	
250	— 2V	—	—	0.9	66000	1500	100	—	—	6SF5 6SF5GT	

† For two tubes at stated plate-to-plate load.

RCA Type	Name	Out-line (see p. 513)	Basing Diagram (see p. 488)	Heater or Filament (F)		Use
				Unless specified all types have heaters. $\oplus$ Heater with controlled warmup time.		
				Volts	Amperes	
6SF7	Diode—Remote-Cutoff Pentode	2A	7AZ	6.3	0.3	Pentode Unit as Class A Amplifier
6SG7	Semiremote-Cutoff Pentode	2A	8BK	6.3	0.3	Class A Amplifier
6SH7	Sharp-Cutoff Pentode	2A	8BK	6.3	0.3	Class A Amplifier
6SJ7GT	Sharp-Cutoff Pentode	13D	8N 8N	6.3	0.3	Class A Amplifier
6SK7	Remote-Cutoff Pentode	2A	8N 8N	6.3	0.3	Class A Amplifier
6SK7GT		13D				
6SN7GT	Medium-Mu Twin Triode	13D	8BD	6.3	0.6	Each Unit as Class A Amplifier
6SN7		13D		6.3	0.6	Each Unit as Vertical Amplifier
GTA				6.3 $\oplus$	0.6	
6SQ7GT	Twin-Diode—High-Mu Triode	13D	8Q 8Q	6.3	0.3	Triode Unit as Class A Amplifier
6SR7	Twin Diode—Medium-Mu Triode	2A	8Q	6.3	0.3	Triode Unit as Class A Amplifier
6SS7	Remote-Cutoff Pentode	2A	8N	6.3	0.15	Class A Amplifier
6ST7	Twin Diode—Medium-Mu Triode	2A	8Q	6.3	0.15	Triode Unit as Amplifier
6SZ7	Twin Diode—High-Mu Triode	2A	8Q	6.3	0.15	Triode Unit as Class A Amplifier
6T4	Medium-Mu Triode	5D	7DK	6.3	0.225	Oscillator in UHF TV Receivers Class A Amplifier
6T7G	Twin Diode—High-Mu Triode	22	7V	6.3	0.15	Triode Unit as Class A Amplifier
6T8	Triple Diode—High-Mu Triode	6B	9E	6.3 6.3 $\oplus$	0.45 0.45	Triode Unit as Class A Amplifier
6U5	Electron-Ray Tube	13H	6R	6.3	0.3	Visual Indicator
6U7G	Remote-Cutoff Pentode	28J	7R	6.3	0.3	Class A Amplifier
6U8	Medium-Mu Triode—Sharp-Cutoff Pentode	6B	9AE	6.3 6.3 $\oplus$	0.45 0.45	Triode Unit as Class A Amplifier Pentode Unit as Class A Amplifier
6V6GT	Beam Power Tube	13D	7AC	6.3	0.45	Single-Tube Class A Amplifier
			7AC 7AC	6.3 6.3 $\oplus$	0.45 0.45	Push-Pull Class AB <sub>1</sub> Amplifier
6V7G	Twin Diode—Low-Mu Triode	23	7V	6.3	0.3	Triode Unit as Amplifier
6W7G	Sharp-Cutoff Pentode	23	7R	6.3	0.15	Class A Amplifier
6X5	Full-Wave Rectifier	2B	6S	6.3	0.6	With Capacitive-Input Filter
			6S			With Inductive-Input Filter
6Y5	Full-Wave Rectifier	22 or 13H	6J	6.3	0.8	With Capacitive-Input Filter
6Y7G	High-Mu Twin Power Triode	22	8B	6.3	0.6	Class B Amplifier
6Z5	Full-Wave Rectifier	22	6K	6.3 12.6	0.8 0.4	With Capacitive-Input Filter
6Z7G	High-Mu Twin Power Triode	22	8B	6.3	0.3	Class B Amplifier
6ZY5G	Full-Wave Rectifier	22	6S	6.3	0.3	With Capacitive-Input Filter
7A4	Medium-Mu Triode	12B	5AC	6.3	0.3	Amplifier
7A5	Beam Power Tube	12C	6AA	6.3	0.75	Class A Amplifier
7A6	Twin Diode	12B	7AJ	6.3	0.15	Detector Rectifier

Plate Supply Volts	Grid Bias Volts (V) or Cathode Resistor Ohms (Ω)	Grid Supply Volts	Grid Current mA	Plate Current mA	AC Plate Resistance Ohms	Trans-conductance Micromhos	Amplification Factor	Load for Stated Power Output Ohms	Power Output Watts	RCA Type
100	— 1V	100	3.4	12.0	200000	1975	—	—	—	6SF7
250	— 1V	100	3.3	12.4	700000	2050	—	—	—	
100	— 1V	100	3.2	8.2	250000	4100	—	—	—	6SG7
250	— 2.5V	150	3.4	9.2	1.0	4000	—	—	—	
100	— 1V	100	2.1	5.3	350000	4000	—	—	—	6SH7
250	— 1V	150	4.1	10.8	900000	4900	—	—	—	
100	— 3V	100	0.9	2.9	700000	1575	—	—	—	6SJ7GT
250	— 3V	100	0.8	3.0	1.0	1650	—	—	—	
100	— 1V	100	4.0	13.0	120000	2350	—	—	—	6SK7
250	— 3V	100	2.6	9.2	800000	2000	—	—	—	6SK7GT
90	0V	—	—	10.0	6700	3000	20	—	—	6SN7GT
250	— 8V	—	—	9.0	7700	2600	20	—	—	6SN7GT
Max. DC Plate Volts, 450			Max. Plate Dissipation: 5 watts either plate; 7.5 watts both plates							
Max. Peak Cathode mA, 70			Max. Peak Positive Pulse Plate Volts, 1500							
100	— 1V	—	—	0.5	110000	925	100	—	—	6SQ7GT
250	— 2V	—	—	1.1	85000	1175	100	—	—	
250	— 9V	—	—	9.5	8500	1900	16	—	—	6SR7
250	— 3V	100	2.0	9.0	1.0	1850	—	—	—	6SS7
For other characteristics, refer to Type 6SR7										
100	— 1V	—	—	0.8	54000	1300	70	—	—	6SZ7
250	— 3V	—	—	1.0	53000	1200	70	—	—	
Max. DC Plate Volts, 200			Max. Grid mA, 8				Max. Plate Dissipation, 3.5 watts			
Max. DC Cathode mA, 30			Max. Plate Dissipation, 3.5 watts							
80	150Ω	—	—	18	—	7000	13	—	—	6T4
250	— 3V	—	—	1.2	62000	1050	65	—	—	
300	4580Ω	—	—	Grid Resistor,** 0.5 MΩ			Gain per stage, 40			
100	— 1V	—	—	0.8	54000	1300	70	—	—	6T8
250	— 3V	—	—	1.0	58000	1200	70	—	—	
Plate & Target Supply, 250 volts. Triode Plate Resistor, 1.0 MΩ Target Current, 4.0 mA										
Grid Bias, —22 volts; Shadow Angle, 0°. Bias, 0 volts; Angle, 90°; Plate Current, 0.24 mA										
250	— 3V	100	2.0	8.2	800000	1600	—	—	—	6U7G
125	— 1V	—	—	13.5	—	7500	40	—	—	6U8
125	— 1V	110	3.5	9.5	200000	5000	—	—	—	
250	—12.5V	250	4.5	45.0	50000	4100	—	5000	4.5	6V6GT
315	—13V	225	2.2	34.0	80000	3750	—	8500	5.5	
250	—15V	250	5.0□	70.0□	—	—	—	10000	10.0†	
285	—19V	285	4.0□	70.0□	—	—	—	8000	14.0†	
For other characteristics, refer to Type 85										
250	— 3V	100	0.5	2.0	1.5	1225	—	—	—	6V7G
For other characteristics, refer to Type 85										
Max. AC Volts per Plate (RMS), 325			Max. DC Output mA, 70			Min. Total Effect. Supply Imped. per Plate, 525 ohms				
Max. Peak Inverse Volts, 1250			Max. Peak Plate mA, 245							
Max. AC Volts per Plate (RMS), 400			Max. DC Output mA, 70			Min. Value of Input Choke, 10 henries				
Max. Peak Inverse Volts, 1250			Max. Peak Plate mA, 245							
Max. AC Volts per Plate (RMS), 350			For other characteristics, refer to Type 79							
Max. DC Output mA, 50										
For other characteristics, refer to Type 79										
Max. AC Volts per Plate (RMS), 230			For other characteristics, refer to Type 79							
Max. DC Output mA, 60										
180	0V	Power Output is for one tube at stated plate-to-plate load						12000	4.2	6Z7G
Max. Peak Inverse Volts, 1250			Max. DC Output mA, 40			Min. Total Effect. Supply Imped. per Plate, 225 ohms				
Max. Peak Plate mA, 120										
For other characteristics, refer to Type 6J5										
110	— 7.5V	110	3.0	40.0	16000	5800	—	2500	1.5	7A5
125	— 9V	125	3.3	44.0	17000	6000	—	2700	2.2	
Max. AC Voltage per Plate, 150 Volts, RMS					Max. DC Output Current per plate, 8 mA					
7A6										

RCA Type	Name	Out-line (see p. 513)	Basing Diagram (see p. 488)	Heater or Filament (F)		Use Values to right give operating conditions and characteristics for indicated typical use
				Unless specified all types have heaters. $\oplus$ Heater with controlled warmup time.		
7A7	Remote-Cutoff Pentode	12B	8V	6.3	0.3	Class A Amplifier
7A8	Octode Converter	12B	8U	6.3	0.15	Converter
7AD7	Power Pentode	12C	8V	6.3	0.6	Class A Amplifier
7AF7	Medium-Mu Twin Triode	12B	8AC	6.3	0.3	Each Unit as Class A Amplifier
7AG7	Sharp-Cutoff Pentode	12B	8V	6.3	0.15	Class A Amplifier
7AH7	Sharp-Cutoff Pentode	12B	8V	6.3	0.15	Class A Amplifier
7B4	High-Mu Triode	12B	5AC	6.3	0.3	Amplifier
7B5	Power Pentode	12C	6AE	6.3	0.4	Class A Amplifier
7B6	Twin Diode—High-Mu Triode	12B	8W	6.3	0.3	Triode Unit as Amplifier
7B7	Remote-Cutoff Pentode	12B	8V	6.3	0.15	Class A Amplifier
7B8	Pentagrid Converter	12B	8X	6.3	0.3	Converter
7C5	Beam Power Tube	12C	6AA	6.3	0.45	Class A Amplifier
7C6	Twin Diode—High-Mu Triode	12B	8W	6.3	0.15	Triode Unit as Class A Amplifier
7C7	Sharp-Cutoff Pentode	12B	8V	6.3	0.15	Class A Amplifier
7E6	Twin Diode—Medium-Mu Triode	12B	8W	6.3	0.3	Triode Unit as Amplifier
7E7	Twin Diode—Remote-Cutoff Pentode	12B	8AE	6.3	0.3	Pentode Unit as Class A Amplifier
7EY6	Beam Power Tube	13F	7AC	7.2 $\oplus$	0.6	Vertical Deflection Amplifier
7F7	High-Mu Twin Triode	12B	8AC	6.3	0.3	Each Unit as Amplifier
7F8	Medium-Mu Twin Triode	12A	8BW	6.3	0.3	Each Unit as Class A Amplifier
7G7	Sharp-Cutoff Pentode	12B	8V	6.3	0.45	Class A Amplifier
7H7	Semiremote-Cutoff Pentode	12B	8V	6.3	0.3	Class A Amplifier
7J7	Triode-Heptode Converter	12B	8BL	6.3	0.3	Triode Unit as Oscillator Heptode Unit as Mixer
7K7	Twin Diode—High-Mu Triode	12B	8BF	6.3	0.3	Triode Unit as Class A Amplifier
7L7	Sharp-Cutoff Pentode	12B	8V	6.3	0.3	Class A Amplifier
7N7	Medium-Mu Twin-Triode	12C	8AC	6.3	0.6	Each Unit as Class A Amplifier
7Q7	Pentagrid Converter	12B	8AL	6.3	0.3	Converter
7R7	Twin Diode—Remote-Cutoff Pentode	12B	8AE	6.3	0.3	Pentode Unit as Class A Amplifier
7S7	Triode-Heptode Converter	12B	8BL	6.3	0.3	Triode Unit as Oscillator Heptode Unit as Mixer
7V7	Sharp-Cutoff Pentode	12B	8V	6.3	0.45	Class A Amplifier
7W7	Sharp-Cutoff Pentode	12B	8BJ	6.3	0.45	Class A Amplifier
7X7	Twin Diode—High-Mu Triode	12C	8BZ	6.3	0.3	Triode Unit as Class A Amplifier
7Y4	Full-Wave Rectifier	12B	5AB	6.3	0.5	With Capacitive-Input Filter
7Z4	Full-Wave Rectifier	12C	5AB	6.3	0.9	With Capacitive-Input Filter
8FQ7	Medium-Mu Twin Triode	6E	9LP	8.4 $\oplus$	0.45	Vertical and Horizontal Deflection Oscillators
9BR7	Twin Diode—High-Mu Triode	6B	9CF	4.7 $\oplus$ 9.4	0.6 0.3	Triode Unit as Class A Amplifier

Types shown in light face are discontinued.



Plate Supply Volts	Grid Bias Volts (V) or Cathode Resistor Ohms (Ω)	Grid Supply Volts	Grid Current mA	Plate Current mA	AC Plate Resistance Ohms	Trans-conductance Micromhos	Amplification Factor	Load for Stated Power Output Ohms	Power Output Watts	RCA Type	
For other characteristics, refer to Type 6SK7										<b>7A7</b>	
250	— 3V	100	3.2	3.0	700000	Anode-Grid (2): 250 max. volts, 4.2 mA Oscillator-Grid No. 1 Resistor. Conversion Transcond., 550 micromhos		—	—	<b>7A8</b>	
300	68Ω	150	7.0	28.0	300000	9500	—	—	—	<b>7AD7</b>	
250	—10V	—	—	9.0	7600	2100	16	—	—	<b>7AF7</b>	
250	250Ω	250	2.0	6.0	1 meg.	4200	—	—	—	<b>7AG7</b>	
250	250Ω	250	1.9	6.8	1 meg.	3300	—	—	—	<b>7AH7</b>	
For other characteristics, refer to Type 6SF5										<b>7B4</b>	
For other characteristics, refer to Type 6K6GT										<b>7B5</b>	
For other characteristics, refer to Type 6SQ7										<b>7B6</b>	
250	— 3V	100	1.7	8.5	750000	1750	—	—	—	<b>7B7</b>	
For other characteristics, refer to Type 6A8										<b>7B8</b>	
For other characteristics, refer to Type 6V6										<b>7C5</b>	
250	— 1V	—	—	1.3	100000	1000	100	—	—	<b>7C6</b>	
250	— 3V	100	0.5	2.0	2.0	1300	—	—	—	<b>7C7</b>	
For other characteristics, refer to Type 6BF6										<b>7E6</b>	
250	330Ω	100	1.6	7.5	700000	1300	—	—	—	<b>7E7</b>	
For other characteristics, refer to Type 6EY6										<b>7EY6</b>	
For other characteristics, refer to Type 6SL7GT										<b>7F7</b>	
250	500Ω	—	—	6.0	—	3300	48	—	—	<b>7F8</b>	
250	— 2V	100	2.0	6.0	800000	4500	—	—	—	<b>7G7</b>	
100	— 1.5V	100	2.6	7.5	350000	4000	—	—	—	<b>7H7</b>	
250	180Ω	150	3.2	10.0	800000	4000	—	—	—		
250	Triode-Grid Resistor, 50000 ohms			5.0	Triode-Grid & Heptode-Grid Current, 0.4 mA					<b>7J7</b>	
250	— 3V	100	2.8	1.4	1.5	Conversion Transcond., 290 μmhos				<b>7K7</b>	
250	— 2V	—	—	2.3	44000	1600	70	—	—		
100	— 1V	100	2.4	5.5	100000	3000	—	—	—	<b>7L7</b>	
250	— 1.5V	100	1.5	4.5	1.0	3100	—	—	—		
For other characteristics, refer to Type 6SN7GT										<b>7N7</b>	
250	— 2V	100	8.5	3.5	1.0	Grid No. 1 Resistor, 20000 ohms Conversion Transcond., 450 μmhos				<b>7Q7</b>	
250	— 1V	100	2.1	5.7	1.0	3200	—	—	—	<b>7R7</b>	
100	Triode-Grid Resistor, 50000 ohms			3.0	—	—	—	—	—	<b>7S7</b>	
250	— 2V	100	3.0	1.8	1.25	Conversion Transcond., 525 μmhos					
300	160Ω	150	3.9	10.0	300000	5800	—	—	—	<b>7V7</b>	
For other characteristics, refer to Type 7V7										<b>7W7</b>	
250	— 1V	—	—	1.9	67000	1500	100	—	—	<b>7X7</b>	
Max. Peak Inverse Volts, 1250				Max. DC Output mA, 70			Max. Peak Plate mA, 180				<b>7Y4</b>
Max. Peak Inverse Volts, 1250				Max. DC Output mA, 100 Max. Peak Plate mA, 300			Min. Total Effec. Supply Imped. per Plate, 75 ohms				<b>7Z4</b>
For other characteristics, refer to Type 6FQ7										<b>8FQ7</b>	
250	200Ω	—	—	10	10900	4000	60	—	—	<b>9BR7</b>	

† For two tubes at stated plate-to-plate load.

□ For two tubes.

RCA Type	Name	Out-line (see p. 513)	Basing Diagram (see p. 488)	Heater or Filament (F)		Use Values to right give operating conditions and characteristics for indicated typical use
				Unless specified all types have heaters. $\phi$ Heater with controlled warmup time.		
				Volts	Amperes	
9CL8	Medium-Mu Triode—Sharp-Cutoff Tetrode	6B	9FX	9.5 $\phi$	0.3	Triode Unit as Class A Amplifier Tetrode Unit as Class A Amplifier
10	Power Triode	27B	4D	7.5F	1.25	Class A Amplifier
10C8	High-Mu Triode—Sharp-Cutoff Pentode	6B	9DA	10.5 $\phi$	0.3	Triode Unit as Class A Amplifier Pentode Unit as Class A Amplifier
11 12	Detector Amplifier	4F 4D	4F 4D	1.1F	0.25	Class A Amplifier
12A5	Power Pentode	22 or 13H	7F	6.3 12.6	0.6 0.3	Class A Amplifier
12A7	Rectifier—Power Pentode	24B	7K	12.6	0.3	Pentode Unit as Class A Amplifier Half-Wave Rectifier
12A8GT	Pentagrid Converter	14A	8A	12.6	0.15	Converter
12AC6	Remote-Cutoff Pentode	5C	7BK	10.0 to 15.9	0.15 approx. at 12.6 V	Class A Amplifier
12AD6	Pentagrid Converter	5C	7CH	10.0 to 15.9	0.15 approx. at 12.6 V	Converter
12AE6	Twin Diode—Medium-Mu Triode	5C	7BT	10.0 to 15.9	0.15 approx. at 12.6 V	Triode Unit as Class A Amplifier
12A6A	Twin Diode—Medium-Mu Triode	5C	7BT	10.0 to 15.9	0.15 approx. at 12.6 V	Triode Unit as Class A Amplifier
12AE7	Dual Triode	6B	9A	10.0 to 15.9	0.45 approx. at 12.6 V	Unit No. 1 as Class A Amplifier Unit No. 2 as Class A Amplifier
12AF6	Remote-Cutoff Pentode	5C	7BK	10.0 to 15.9	0.15 approx. at 12.6 V	Class A Amplifier
12AH7 GT	Medium-Mu Twin Triode	13C	8BE	12.6	0.15	Each Unit as Class A Amplifier
12AJ6	Twin Diode—Medium-Mu Triode	5C	7BT	10.0 to 15.9	0.15 approx. at 12.6 V	Triode Unit as Class A Amplifier
12AL8	Medium-Mu Triode—Power Tetrode	6E	9GS	10.0 to 15.9	0.55 approx. at 12.6 V	Triode Unit as Class A Amplifier Tetrode Unit as Class A Amplifier
12AU7	Medium-Mu Twin Triode	6B	9A	6.3 12.6	0.3 0.15	Each Unit as Class A Amplifier
12AV7	Medium-Mu Twin Triode	6B	9A	6.3 12.6	0.45 0.225	Each Unit as Class A Amplifier
12AX4- GT 12AX4- GTA	Half-Wave Rectifier	13D 13D	4CG	12.6 12.6 $\phi$	0.6 0.6	Television Damper Service
12AX7	High-Mu Twin-Triode	6B	9A	6.3 12.6	0.3 0.15	Each Unit as Class A Amplifier
12AZ7	High-Mu Twin-Triode	6B	9A	6.3 12.6	0.45 0.225	Each Unit as Class A Amplifier
12B8GT	High-Mu Triode—Remote-Cutoff Pentode	—	8T	12.6	0.3	Triode Unit as Class A Amplifier Pentode Unit as Class A Amplifier

Plate Supply Volts	Grid Bias Volts (V) or Cathode Resistor Ohms (Ω)	Grid Supply Volts	Grid Current mA	Plate Current mA	AC Plate Resistance Ohms	Trans-conductance Micromhos	Amplification Factor	Load for Stated Power Output Ohms	Power Output Watts	RCA Type
125	56Ω	—	—	15	5000	8000	40	—	—	9C18
125	— 1V	125	4	12	100000	5800	—	—	—	
425	—40V	—	—	18.0	5000	1600	8.0	10200	1.6	10
250	390Ω	—	—	7.3	12000	4400	53	—	—	10C8
135	100Ω	135	3.2	11.5	190000	8000	—	—	—	
135	—10.5V	—	—	3	15500	440	—	—	—	11 12
180	—25V	180	8.0	45.0	35000	2400	—	3300	3.4	12A5
135	—13.5V	135	2.5	9.0	100000	975	—	13500	0.55	12A7
Maximum AC Plate Voltage.....								125 Volts, RMS		
Maximum DC Output Current.....								30 Milliamperes		
For other characteristics, refer to Type 6A8GT										12A8GT
12.6	—	12.6	.2	.55	500000	730	{Grid-No. 1 Supply Volts, 0 Grid-No. 1 Res., 2.2 megohms}		12AC6	
12.6	Self-excited	12.6	1.5	0.45	1	Grid-No. 1 Resistor, 33000 ohms Conversion Transcond., 260 micromhos			12AD6	
12.6	0V	—	—	0.75	15000	1000	15	—	—	12AE6
12.6	0V	—	—	1	13000	1300	16.7	—	—	12AE6A
12.6	Grid Res. 1.5 megohms	—	—	1.9	3150	4000	13.0	—	—	12AE7
12.6	Grid Res. 1 megohm	—	—	7.5	985	6500	6.4	—	—	
12.6	—	12.6	0.45	1.1	350000	1500	{Grid-No. 1 Supply Volts, 0 Grid-No. 1 Res., 2.2 megohms}		12AF6	
180	— 6.5V	—	—	7.6	8400	1900	16	—	—	12AH7 GT
12.6	{Grid-No. 1 Supply Volts, 0 Grid-No. 1 Res., 2.2 megohms}		0.75	45000	1200	55	—	—	—	12AJ6
12.6	— 0.9V (across 2.2 megohm res.)		.5	13000	1000	13	—	—	—	12AL8
Grid-No. 2 (Control Grid) Volts, —.5 (across 2.2 megohm res.)					Ampl. Factor (Grid-No. 2 to Plate) 7.2					
Grid-No. 1 (Space-Charge Grid) Volts, 12.6					Grid-No. 1 mA, 75			Plate mA, 40		
Transcond. (Grid-No. 2 to Plate), 15000 μmhos					Plate Resistance, 480 ohms					
100	0V	—	—	11.8	6250	3100	19.5	—	—	12AU7
250	— 8.5V	—	—	10.5	7700	2200	17	—	—	
150	56Ω	—	—	18	48000	8500	41	Cutoff Volts, —12		12AV7
Max. Peak Inverse Plate Volts, 4400					Max. Peak Heater-Cathode Volts: { —4400 +300 DC component must not exceed 900 volts					12AX4- GT
Max. Peak Plate mA, 750										12AX4- GTA
Max. DC Plate mA, 125										
100	— 1V	—	—	0.5	80000	1250	100	—	—	12AX7
250	— 2V	—	—	1.2	62500	1600	100	—	—	
100	270Ω	—	—	3.7	15000	4000	60	—	—	12AZ7
250	200Ω	—	—	10.0	10900	5500	60	—	—	
90	0V	—	—	2.8	37000	2400	90	—	—	12B8GT
90	— 3V	90	2	7	200000	1800	—	—	—	

RCA Type	Name	Out-line (see p. 513)	Basing Diagram (see p. 488)	Heater or Filament (F)		Use Values to right give operating conditions and characteristics for indicated typical use
				Unless specified all types have heaters. $\oplus$ Heater with controlled warmup time.		
				Volts	Amperes	
12BA7	Pentagrid Converter	6E	8CT	12.6	0.15	Converter
12BD6	Remote-Cutoff Pentode	5C	7BK	12.6	0.15	Class A Amplifier
12BF6	Twin Diode—Medium-Mu Triode	5C	7BT	12.6	0.15	Triode Unit as Class A Amplifier
12BH7	Medium-Mu Twin Triode	6E	9A	6.3 $\oplus$ 12.6	0.6 0.3	Vertical Deflection Amplifier
12BK5	Beam Power Tube	6E	9BQ	12.6 $\oplus$	0.6	Class A Amplifier
12BL6	Remote-Cutoff Pentode	5C	7BK	10.0 to 15.9	0.15 approx. at 12.6V	Class A Amplifier
12BR7	Twin Diode—High-Mu Triode	6B	9CF	6.3 12.6	0.45 0.225	Triode Unit as Class A Amplifier
12BV7	Sharp-Cutoff Pentode	6E	9BF	6.3 12.6	0.6 0.3	Class A Amplifier
12BW4	Full-Wave Rectifier	6E	9DJ	6.3	0.9	With Capacitive Input Filter With Inductive Input Filter
12BY7	Sharp-Cutoff Pentode	6E	9BF	6.3 $\oplus$ 12.6	0.6 0.3	Class A Amplifier
12C8	Twin Diode—Semiremote-Cutoff Pentode	3	8E	12.6	0.15	Pentode Unit as RF Amplifier
12CN5	Remote-Cutoff Pentode	5D	7CV	10.0 to 15.9	0.45 approx. at 12.6V	Class A Amplifier
12CT8	Medium-Mu Triode—Sharp-Cutoff Pentode	6E	9DA	12.6 $\oplus$	0.3	Triode Unit as Class A Amplifier Pentode Unit as Class A Amplifier
12CX6	Remote-Cutoff Pentode	5C	7BK	10.0 to 15.9	0.15 approx. at 12.6V	Class A Amplifier
12DE8	Diode—Remote-Cutoff Pentode	6B	9HG	10.0 to 15.9	0.2 approx. at 12.6V	Pentode Unit as Class A Amplifier
12DK7	Twin Diode—Power Tetrode	6E	9HZ	10.0 to 15.9	0.5 approx. at 12.6V	Tetrode Unit as Class A Amplifier
12DL8	Twin Diode—Power Tetrode	6E	9HR	10.0 to 15.9	0.55 approx. at 12.6V	Tetrode Unit as Class A Amplifier
12DM4	Half-Wave Rectifier	13F	4CG	12.6 $\oplus$	0.6	Television Damper Service
12DQ6A	Beam Power Tube	20	6AM	12.6 $\oplus$	0.6	Horizontal Deflection Amplifier
12DQ7	Power Pentode	6E	9BF	6.3 $\oplus$ 12.5	0.6 0.3	Class A Amplifier
12DS7 12DS7A	Twin Diode—Power Tetrode	6E 6E	9JU	10.0 to 15.9	0.4 approx. at 12.6V	Tetrode Unit as Class A Amplifier
Diode Units						
12DU7	Twin Diode—Power Tetrode	6B	9JX	10.0 to 15.9	0.25 approx. at 12.6V	Tetrode Unit as Class A Amplifier
12DV8	Twin Diode—Power Tetrode	6E	9HR	10.0 to 15.9	0.375 approx. at 12.6V	Class A Amplifier
12DW7	Dual Triode	6B	9A	12.6 6.3	0.15 0.3	Unit No. 1 as Class A Amplifier Unit No. 2 as Class A Amplifier
12DY8	Medium-Mu Triode—Remote-Cutoff Tetrode	6B	9JD	10.0 to 15.9	0.35 approx. at 12.6V	Triode Unit as Class A Amplifier Tetrode Unit as Signal Seeker Relay
12EA6	Remote-Cutoff Pentode	5C	7BK	10.0 to 15.9	0.19 approx. at 12.6V	Class A Amplifier

Plate Supply Volts	Grid Bias or Cathode Resistor Volts (V) or Ohms ( $\Omega$ )	Grid Supply Volts	Grid Current mA	Plate Current mA	AC Plate Resistance Ohms	Trans-conductance Micromhos	Amplification Factor	Load for Stated Power Output Ohms	Power Output Watts	RCA Type
For other characteristics, refer to Type 6BA7										12BA7
For other characteristics, refer to Type 6BD6										12BD6
250	— 9V	—	—	9.5	8500	1900	16	Power Output, 300 milliwatts	—	12BF6
Max. DC Plate Volts, 450 Max. DC Plate mA, 20				Absolute Max. Peak Positive-Pulse Plate Volts, 1500 Max. Plate Dissipation (Each Unit), 3.5 watts						12BH7
250	— 5V	250	3.5	35	100000	8500	—	6500	3.5	12BK5
12.6	Grid-No. 1 Supply Volts, 0	12.6	0.5	1.35	500000	1350	Grid-No. 1 and Grid-No. 3 Volts for transcond. of 10 micromhos, —5			12BL6
100	270 $\Omega$	—	—	3.7	15000	4000	60	—	—	12BR7
250	200 $\Omega$	—	—	10	10900	5500	60	—	—	12BR7
250	68 $\Omega$	150	6	27	85000	13000	—	—	—	12BV7
250	— 8V	180	—	0.5	—	—	—	—	—	12BV7
For other characteristics, refer to 6BW4										12BW4
250	100 $\Omega$	180	5.75	26	93000	11000	—	—	—	12BY7
250	— 3V	125	2.3	10	600000	1325	—	—	—	12C8
12.6	—	12.6	3.5	4.5	40000	3800	[Grid-No. 1 Supply Volts, 0 [Grid-No. 1 Res., 2.2 megohms]		—	12CN5
150	150 $\Omega$	—	—	9	8200	4900	40	—	—	12CT8
200	82 $\Omega$	125	3.4	15	150000	7000	—	—	—	12CT8
12.6	Grid-No. 1 Supply Volts, 0	12.6	1.4	3	40000	3100	Grid-No. 1 Volts for Plate Current of 10 $\mu$ A, —4.5			12CX6
12.6	—	12.6	0.5	1.3	300000	1500	Grid No. 1 Supply Volts, 0 Grid-No. 1 Res., 2.2 megohms			12DE8
12.6	—	12.6	1	6	4000	5000	—	3500	0.010	12DK7
12.6	Grid-No. 2 (Control Grid) Volts, —0.5 (across 2.2 megohm resistor) Grid-No. 1 (Space-Charge Grid) Volts, 12.6 Transcond. (Grid-No. 2 to Plate), 15000 $\mu$ mhos				Ampl. Factor (Grid-No. 2 to Plate) 7.2 Grid-No. 1 mA, 75 Plate Resistance, 480 ohms					12DL8
For other characteristics, refer to Type 6DM4										12DM4
Max. DC Plate Volts, 700 Max. DC Cathode mA, 140				Max. Peak Positive-Pulse Plate Volts, 6000 (Abs.) Max. Plate Dissipation, 15 watts						12DQ6A
200	68 $\Omega$	125	5.6	26	53000	10500	—	—	—	12DQ7
12.6	12.6V	—0.5 (across 2.2 megohm resistor)	75 (Grid-No. 1)	35	500	19000 (Grid-No. 2 to Plate)	9.1 (Grid-No. 2 to Plate)	—	—	12DS7 12DS7A
Diode Plate mA, with 10 Volts Applied, 3 mA										
12.6	—	12.6	1.5	12	6000	6200	—	2700	0.025	12DU7
Grid-No. 2 (Control Grid) Resistor, 4.7 megohms Grid-No. 1 (Space-Charge Grid) Volts, 12.6 Transcond. (Grid-No. 2 to Plate), 8500 $\mu$ mhos				Ampl. Factor (Grid-No. 2 to Plate) 7.6 Grid-No. 1 mA, 53 Plate Resistance, 900 ohms						12DV8
250	— 2V	—	—	1.2	62500	—	100	—	—	12DW7
250	— 8.5V	—	—	10.5	7700	2200	17	—	—	12DW7
12.6	—	—	—	1.2	10000	2000	20	—	—	12DW7
10	—	10	—	5 min.	Grid No. 1 resistor	10 megohms.	Plate Load 700 ohms			12DY8
15	— 6V	15	—	3 max.	—	—	Plate Load 700 ohms			12DY8
12.6	—	12.6	1.4	3.2	32000	3800	[Grid-No. 1 Supply Volts, 0 [Grid-No. 1 Res., 10 megohms]			12EA6

RCA Type	Name	Out-line (see p. 513)	Basing Diagram (see p. 488)	Heater or Filament (F)		Use Values to right give operating conditions and characteristics for indicated typical use
				Unless specified all types have heaters. ⊕ Heater with controlled warmup time.		
				Volts	Amperes	
12EC8	Medium-Mu Triode—Semiremote-Cutoff Pentode	6B	9FA	10.0 to 15.9	0.225 approx. at 12.6V	Triode Unit as Class A Amplifier
				Pentode Unit as Class A Amplifier		
12ED5	Beam Power Tube	5D	7CV	12.6 ⊕	0.45	Class A Amplifier
12EG6	Pentagrid Amplifier	5C	7CH	10.0 to 15.9	0.15 approx. at 12.6V	Class A Amplifier
12EK6	Remote-Cutoff Pentode	5C	7BK	10.0 to 15.9	0.19 approx. at 12.6V	Class A Amplifier
12EL6	Twin Diode—High-Mu Triode	5C	7FB	10.0 to 15.9	0.15 approx. at 12.6V	Class A Amplifier
12EM6	Diode—Power Tetrode	6E	9HV	10.0 to 15.9	0.5 approx. at 12.6V	Class A Amplifier
12EN6	Beam Power Tube	13D	7AC	12.6 ⊕	0.6	Vertical Deflection Amplifier
12F5GT	High-Mu Triode	14A	5M	12.6	0.15	Amplifier
12F8	Twin Diode—Remote-Cutoff Pentode	6B	9FH	10.0 to 15.9	0.15 approx. at 12.6V	Pentode Unit as Class A Amplifier
12FK6	Twin Diode—Low-Mu Triode	5C	7BT	10.0 to 15.9	0.15 approx. at 12.6 V	Triode Unit as Class A Amplifier
12FM6	Twin Diode—Medium-Mu Triode	5C	7BT	10.0 to 15.9	0.15 approx. at 12.6V	Triode Unit as Class A Amplifier
12FV7	Medium-Mu Twin Triode	6E	9A	6.3 to 12.6	0.9 to 0.45	Each Unit as Class A Amplifier
12FX8	Medium-Mu Triode—Pentagrid Converter	6D	9KV	10.0 to 15.9	0.3 approx. at 12.6V	Triode Unit as Class A Amplifier
				Pentagrid Unit as Converter		
12GA6	Pentagrid Converter	5C	7CH	10.0 to 15.9	0.15 approx. at 12.6V	Converter
12GC6	Beam Power Tube	20	8JX	12.6	0.6	Horizontal Deflection Amplifier
12GJ5	Novar Beam Power Tube	18A	9QK	12.6 ⊕	0.6	Horizontal Deflection Amplifier
12J5GT	Medium-Mu Triode	13D	6Q	12.6	0.15	Amplifier
12J7GT	Sharp-Cutoff Pentode	14A	7R	12.6	0.15	Amplifier
12J8	Twin Diode—Power Tetrode	6B	9GC	10.0 to 15.9	0.325 approx. at 12.6V	Tetrode Unit as Class A Amplifier
				Class A Amplifier		
12K5	Power Tetrode	5D	7EK	10.0 to 15.9	0.4 approx. at 12.6V	Class A Amplifier
12K7GT	Remote-Cutoff Pentode	14A	7R	12.6	0.15	Amplifier
12K8	Triode-Hexode Converter	3	8K	12.6	0.15	Oscillator Mixer
12KL8	Diode—Sharp-Cutoff Pentode	6E	9LQ	12.6 ⊕	0.15	Pentode Unit as Class A Amplifier
12L6GT	Beam Power Tube	13D	7AC	12.6 ⊕	0.6	Class A Amplifier
12Q7GT	Twin Diode—High-Mu Triode	14A	7V	12.6	0.15	Triode Unit as Amplifier
12R5	Beam Power Tube	5D	7CV	12.6 ⊕	0.6	Vertical Deflection Amplifier

Plate Supply Volts	Grid Bias Volts (V) or Cathode Resistor Ohms ( $\Omega$ )	Grid Supply Volts	Grid Current mA	Plate Current mA	AC Plate Resistance Ohms	Trans-conductance Micromhos	Amplification Factor	Load for Stated Power Output Ohms	Power Output Watts	RCA Type	
12.6	4700 $\Omega$ (Grid Res.)	—	—	2.4	6000	4700	25	—	—	12EC8	
12.6	—	12.6	0.28	0.66	750000	2000	Grid No. 1 Res., 33000 ohms				
1.25	— 4.5V	125	7	37	14000	8500	—	4500	1.5	12ED5	
12.6	— 0.6V†	12.6	2.8	.55	150000	800	‡Between Grid No. 3 & Plate †Bias voltage across res. 2.2 megohms			12EG6	
12.6	—	12.6	1.7	4	50000	4200	Grid-No. 1 Supply Volts, 0 Grid-No. 1 Res. (Bypassed), 2.2 megohms			12EK6	
12.6	0V	—	—	0.75	45000	1200	55	—	—	12EL6	
12.6	—	12.6	1	6	4000	5000	Grid-No. 1 Res., 2.2 megohms			12EM6	
Max. Peak Pos.-Pulse Volts, 1200 Max. Peak Neg.-Pulse Grid Volts, 250 Max. Peak Cathode mA, 175						Max. Plate Dissipation, 7 watts Max. DC Plate Volts, 300			12EN6		
For other characteristics, refer to Type 6F5GT										12F5GT	
12.6	0V	12.6	0.38	1	330000	1000	Grid-No. 1 Volts for trans- cond. of 10 micromhos, —5			12F8	
12.6	Grid Supply Volts, 0 Grid Res. (Bypassed), 2.2 megohms	—	—	1.3	6200	1200	7.4	—	—	12FK6	
12.6	0V	—	—	1	7700	1300	10	—	—	12FM6	
100	— 2V	—	—	16	2250	9600	21.5	—	—	12FV7	
12.6	—	—	—	1.3	7150	1400	10	Grid Res., 2.2 megohms		12FX8	
12.6	—	12.6	1.25	0.29	500000	Grid No. 3 Res., 2.2 megohms Conversion Transcond., 300 $\mu$ hos					
12.6	1.6V	12.6	0.8	0.3	1	Grid No. 1 Res., 33000 ohms Conversion. Transcond., 140 $\mu$ hos				12GA6	
Max. DC Plate Volts, 770 Max. DC Cathode mA, 175						Max. Peak Positive-Pulse Plate Volts, 6500 Max. Plate Dissipation 17.5 watts			12GC6		
For other characteristics, refer to Type 6GJ5										12GJ5	
For other characteristics, refer to Type 6J5GT										12J5GT	
For other characteristics, refer to Type 6J7GT										12J7GT	
12.6	— 0V	12.6	1.5	12	6000	5500	—	2700	0.02	12J8	
DC Plate Volts, 12.6 Grid-No. 1 (Space-Charge Grid) Volts, 12.6 DC Plate mA, 40		Grid-No. 2 (Control Grid) Volts, —.5 Grid-No. 2 (Control Grid) Volts, 12.6 Grid-No. 1 mA, 75		—		Amplification Factor, Grid-No. 2 to Plate, 7.2 Transcond., Grid-No. 2 to Plate, 15000 $\mu$ hos		Plate Resistance, 480 ohms Grid-No. 2 to Plate, 7.2			12K5
For other characteristics, refer to Type 6K7GT										12K7GT	
For other characteristics, refer to Type 6K8										12K8	
For other characteristics, see Type 6KL8										12KL8	
110 200	— 7.5V 180 $\Omega$	110 125	4.0 2.2	49 46	13000 28000	8000 8000	— —	2000 4000	2.1 3.8	12L6GT	
For other characteristics, refer to Type 6Q7GT										12Q7GT	
Max. DC Plate Volts, 150 Max. Peak Cathode mA, 155 Max. Plate Dissipation, 4.5 watts						Max. Peak Neg.-Pulse Grid-No. 1 Volts, 150 Max. Grid-No. 2 Volts, 150 Max. Peak Positive-Pulse Plate Volts, 1500 (Abs.)				12R5	

RCA Type	Name	Out-line (see p. 513)	Basing Diagram (see p. 488)	Heater or Filament (F)		Use Values to right give operating conditions and characteristics for indicated typical use
				Unless specified all types have heaters. $\emptyset$ Heater with controlled warmup time.		
				Volts	Amperes	
12S8GT	Triple Diode—High-Mu Triode	14B	8CB	12.6	0.15	Triode Unit as Class A Amplifier
12SA7 GT	Pentagrid Converter	13D	8R 8AD	12.6	0.15	Converter
12SC7	High-Mu Twin Triode	2A	8S	12.6	0.15	Each Unit as Class A Amplifier
12SF5 12SF5 GT	High-Mu Triode	2A 13D	8AB 6AB	12.6	0.15	Class A Amplifier
12SF7	Diode—Remote-Cutoff Pentode	2A	7AZ	12.6	0.15	Pentode Unit as Amplifier
12SG7	Semiremote-Cutoff Pentode	2A	8BK	12.6	0.15	Class A Amplifier
12SH7	Remote-Cutoff Pentode	3	8BK	12.6	0.15	Class A Amplifier
12SJ7 GT	Sharp-Cutoff Pentode	13D	8N 8N	12.6	0.15	Class A Amplifier
12SK7 12SK7 GT	Remote-Cutoff Pentode	2A 13D	8N 8N	12.6	0.15	Class A Amplifier
12SN7 GT	Medium-Mu Twin Triode	13D	8BD	12.6	0.3	Each Unit as Class A Amplifier
12SQ7 GT	Twin Diode—High-Mu Triode	13D	8Q 8Q	12.6	0.15	Triode Unit as Class A Amplifier
12SR7 12SR7 GT	Twin Diode—Medium-Mu Triode	2A 13D	8Q 8Q	12.6	0.15	Triode Unit as Class A Amplifier
12U7	Medium-Mu Twin Triode	6B	7CK	10.0 to 15.9	0.15 approx. at 12.6V	Each Unit as Class A Amplifier
12Z3	Half-Wave Rectifier	22	4G	12.6	0.3	With Capacitive-Input Filter
14A4	Medium-Mu Triode	12B	5AC	12.6	0.15	Class A Amplifier
14A5	Beam Power Tube	12B	6AA	12.6	0.15	Class A Amplifier
14A7	Remote-Cutoff Pentode	12B	8V	12.6	0.15	Class A Amplifier
14AF7	Medium-Mu Twin-Triode	12B	8AC	12.6	0.15	Each Unit as Class A Amplifier
14B6	Twin Diode—High-Mu Triode	12B	8W	12.6	0.15	Triode Unit as Class A Amplifier
14B8	Pentagrid Converter	12B	8X	12.6	0.15	Converter
14C5	Beam Power Tube	12C	6AA	12.6	0.225	Class A Amplifier
14C7	Sharp-Cutoff Pentode	12B	8V	12.6	0.15	Class A Amplifier
14E6	Twin Diode—Medium-Mu Triode	12B	8W	12.6	0.15	Triode Unit as Class A Amplifier
14E7	Twin Diode—Remote-Cutoff Pentode	12B	8AE	12.6	0.15	Pentode Unit as Class A Amplifier
14F7	High-Mu Twin Triode	12B	8AC	12.6	0.15	Each Unit as Class A Amplifier
14F8	Medium-Mu Twin Triode	12A	8BW	12.6	0.15	Each Unit as Class A Amplifier
14H7	Semiremote-Cutoff Pentode	12B	8V	12.6	0.15	Class A Amplifier
14J7	Triode-Heptode Converter	12B	8BL	12.6	0.15	Converter
14N7	Medium-Mu Twin Triode	12C	8AC	12.6	0.3	Each Unit as Class A Amplifier
14Q7	Pentagrid Converter	12B	8AL	12.6	0.15	Converter
14R7	Twin Diode—Remote-Cutoff Pentode	12B	8AE	12.6	0.15	Pentode Unit as Class A Amplifier
15	Sharp-Cutoff Pentode	24B	5F	2.0	0.22	Class A Amplifier
17AX4 GT	Half-Wave Rectifier	13D	4CG	16.8 $\emptyset$	0.45	Television Damper Service





RCA Type	Name	Out- line (see p. 513)	Basing Dia- gram (see p. 488)	Heater or Filament (F)		Use  Values to right give operat- ing conditions and character- istics for indicated typical use
				Unless specified all types have heaters. ⊕ Heater with con- trolled warmup time.		
				Volts	Amperes	
17DM4	Half-Wave Rectifier	13G	4CG	16.8⊕	0.45	Television Damper Service
17DQ6A	Beam Power Tube	2D	6AM	16.8⊕	0.45	Horizontal Deflection Amplifier
17GJ5	Novar-Beam Power Tube	18A	9QK	16.8⊕	0.45	Horizontal Deflection Amplifier
17H3	Half-Wave Rectifier	6E	9FK	17.5⊕	0.3	Television Damper Service
17JG6	Beam Power Tube	17B	9QU	16.8⊕	0.6	Horizontal Deflection Amplifier
17LD8	Medium-Mu Triode—Sharp-Cutoff Pentode	10F	9QT	16.8⊕	0.45	Horizontal Deflection Amplifier Triode Unit as Class A Amplifier Pentode Unit as Class A Amplifier
18A5	Beam Power Tube	13F	6CK	18.5⊕	0.3	Horizontal Deflection Amplifier
18FW6	Remote-Cutoff Pentode	5C	7CC 7CC	18.0 18.0⊕	0.1 0.1	Class A Amplifier
18FX6	Pentagrid Converter	5C	7CH 7CH	18.0 18.0⊕	0.1 0.1	Converter
18FY6	Twin Diode—High-Mu Triode	5C	7BT 7BT	18.0 18.0⊕	0.1 0.1	Triode Unit as Class A Amplifier
19	High-Mu Twin Power Triode	22 or 13H	6C	2.0F	0.26	Amplifier
19AU4 GTA	Half-Wave Rectifier	13G	4CG	18.9⊕	0.6	Television Damper Service
19B66G 19B66 GA	Beam Power Tube	27B	5BT	18.9	0.3	Horizontal Deflection Amplifier
19J6	Medium-Mu Twin Triode	5C	7BF	18.9	0.15	Each Unit as Class A Amplifier
19T8	Triple Diode—High-Mu Triode	—	9E	18.9	0.15	Triode Unit as Class A Amplifier
20	Power Triode	—	4D	3.3F	0.132	Class A Amplifier
20EQ7	Diode—Remote-Cutoff Pentode	6E	9LQ	20.0	0.1	Pentode Unit as Class A Amplifier
21EX6	Beam Power Tube	21B	5BT	21.5⊕	0.6	Horizontal Deflection Amplifier
22	Sharp-Cutoff Tetrode	29K	4K	3.3F	0.132	Screen-Grid RF Amplifier
22JG6	Beam Power Tube	17B	9QU	22⊕	0.45	Horizontal Deflection Amplifier
24A	Sharp-Cutoff Tetrode	29K	5E	2.5	1.75	Screen-Grid RF Amplifier
25A6 25A6GT	Power Pentode	2B 13D	7S 7S	25.0	0.3	Class A Amplifier
25A7GT	Rectifier—Power Pentode	13D	8F	25.0	0.3	Pentode Unit as Class A Amplifier Half-Wave Rectifier
25AC5 GT	High-Mu Power Triode	13D	6Q	25.0	0.3	Amplifier
25B5	Direct-Coupled Power Amplifier	—	6D	25.0	0.3	Amplifier
25B6G	Power Pentode	25	7S	25.0	0.3	Class A Amplifier
25B8GT	High-Mu Triode—Remote-Cutoff Pentode	13D	8T	25.0	0.15	Triode Unit as Class A Amplifier Pentode Unit as Class A Amplifier
25BK5	Beam Power Tube	6E	9BQ	25	0.3	Class A Amplifier
25BQ6 GT	Beam Power Tube	14D	6AM	25.0	0.3	Horizontal Deflection Amplifier
25C6G	Beam Power Tube	25	7AC	25.0	0.3	Class A Amplifier
25CD6 GA	Beam Power Tube	21B	5BT 5BT	25⊕ 25⊕	0.6	Horizontal Deflection Amplifier

Plate Supply Volts	Grid Bias Volts (V) or Cathode Resistor Ohms ( $\Omega$ )	Grid Supply Volts	Grid Current mA	Plate Current mA	AC Plate Resistance Ohms	Trans-conductance Micromhos	Amplification Factor	Load for Stated Power Output Ohms	Power Output Watts	RCA Type	
For other ratings, refer to Type 6DM4										17DM4	
Max. DC Plate Volts, 700 Max. DC Cathode mA, 140					Max. Peak Positive-Pulse Plate Volts, 6000 (Abs.) Max. Plate Dissipation, 15 watts					17DQ6A	
For other ratings, refer to Type 6GJ5										17GJ5	
Max. Peak Inverse Plate Volts, 2000 Max. Peak Plate mA, 450					Max. Average Plate mA, 75 Max. Plate Dissipation, 3 watts					17H3	
For other characteristics, refer to Type 17JG6A										17JG6	
150	— 5V	—	—	3.3	11300	1900	21.5	—	—	17LD8	
120	— 8V	110	4	46	11700	7100	—	—	—	17LD8	
Max. DC Plate Volts, 350 Max. DC Cathode mA, 90					Max. Peak Pos.-Pulse Plate Volts, 3000 Max. Plate Dissipation, 9 watts					18A5	
100	68 $\Omega$	100	4.4	11	250000	4400	—	—	—	18FW6	
100	— 1.5V	100	6.2	2.3	400000	Grid No. 1 Resistor, 20000 ohms Conversion Transcond., 480 $\mu$ mhos				18FX6	
100	— 1V	—	—	0.6	77000	1300	100	—	—	18FY6	
For other characteristics, refer to Type 1J6GT										19	
For other ratings, refer to Type 6AU4GTA										19AU4 GTA	
Max. DC Plate Volts, 700 Max. DC Plate Current, 110 mA.					Max. Peak Positive-Pulse Plate Volts, 6600 (Abs.) Max. Plate Dissipation, 20 watts					19B6G6 19B6G GA	
100	50 $\Omega$ (For both units at the specified conditions)			8.5	7100	5300	38	—	—	19J6	
For other characteristics, refer to Type 6T8A										19T8	
135	—22.5V	—	—	6.5	6300	525	3.3	6500	0.110	20	
For other characteristics, refer to Type 6EQ7										20EQ7	
For other ratings, refer to Type 6EX6										21EX6	
135	— 1.5V	67.5	1.3 (Max.)	3.7	325000	500	—	—	—	22	
For other characteristics, refer to Type 22JG6A										22JG6	
250	— 3V	90	1.7 (Max.)	4.0	600000	1050	—	—	—	24A	
95	—15V	95	4	20	45000	2000	—	4500	0.9	25A6 25A6GT	
100	—15V	100	4.0	20.5	50000	1800	—	4500	0.77	25A7 GT	
Max. AC Plate Volts (RMS), 117					Max. DC Output mA, 75			Max. Peak Plate mA, 450			25AC5 GT
110	+15V (Grid mA, 7)			15	15200	3800	58	—	—	25AC5 GT	
For other characteristics, refer to Type 25N6G										25B5	
200	—23V	135	1.8	62.0	18000	5000	—	2500	7.1	25B6G	
100	— 1V	—	—	0.6	75000	1500	112	—	—	25B8GT	
100	— 3V	100	2.0	7.6	185000	2000	—	—	—	25B8GT	
For other characteristics, refer to Type 6BK5										25BK5	
Max. DC Plate Volts, 600 Max. DC Cathode mA, 112.5					Absolute Max. Peak Positive-Pulse Plate Volts, 6000 (Abs.) Max. Plate Dissipation, 11 Watts					25BQ6 GT	
For other characteristics, refer to Type 6Y6G										25C6G	
Max. DC Plate Volts, 700 Max. DC Plate mA, 200					Max. Peak Positive-Plus Plate Volts, 7000 Max. Plate Dissipation, 20 Watts					25CD6 GA	

RCA Type	Name	Out-line (see p. 513)	Basing Diagram (see p. 488)	Heater or Filament (F)		Use Values to right give operating conditions and characteristics for indicated typical use
				Unless specified all types have heaters. $\oplus$ Heater with controlled warmup time.		
				Volts	Amperes	
25EC6	Beam Power Tube	21A	5BT	25.0 $\oplus$	0.6	Horizontal Deflection Amplifier
25L6	Beam Power Tube	2B	7AC	25.0	0.3	Amplifier
25L6GT	Beam Power Tube	13D	7AC	25.0	0.3	Amplifier
25N6G	Direct-Coupled Power Amplifier	—	7W	25.0	0.3	Class A Amplifier
25W4GT	Half-Wave Rectifier	13D	4CG	25.0	0.3	Television Damper Service
25Y5	Rectifier-Doubler	22 or 13H	6E	25.0	0.3	Half-Wave Rectifier
25Z5	Rectifier-Doubler	22 or 13H	6E	25.0	0.3	Rectifier-Doubler
25Z6	Rectifier-Doubler	2B	7Q	25.0	0.3	Voltage Doubler
25Z6GT		13D	7Q	25.0	0.3	Half-Wave Rectifier
26	Medium-Mu Triode	26	4D	1.5F	1.05	Class A Amplifier
27	Low-Mu Triode	22 or 13H	5A	2.5	1.75	Class A Amplifier
30	Medium-Mu Triode	22 or 13H	4D	2.0F	0.06	Amplifier
31	Power Triode	22 or 13H	4D	2.0F	0.13	Class A Amplifier
32	Sharp-Cutoff Tetrode	29K	4K	2.0F	0.06	Class A Amplifier
32ET5	Power Pentode	5D	7CV	32.0	0.1	Class A Amplifier
32L7GT	Rectifier—Beam Power Tube	14A	8Z	32.5	0.3	Class A Amplifier Half-Wave Rectifier
33	Power Pentode	25	5K	2.5F	0.26	Class A Amplifier
34	Remote-Cutoff Pentode	29K	4M	2.0F	0.06	Screen-Grid RF Amplifier
34GD5	Beam Power Tube	5D	7CV 7CV	34.0 34.0 $\oplus$	0.1 0.1	Class A Amplifier
35	Remote-Cutoff Tetrode	29K	5E	2.5	1.75	Screen-Grid RF Amplifier
35A5	Beam Power Tube	12C	6AA	35.0	0.15	Single-Tube Class A Amplifier
35B5	Beam Power Tube	5D	7BZ	35.0	0.15	Class A Amplifier
35DZ8	High-Mu Triode—Power Pentode	6H	9JE	35.0	0.15	Triode Unit as Class A Amplifier Pentode Unit as Class A Amplifier
35GL6	Beam Power Tube	5D	7FZ	35.0	0.15	Class A Amplifier
35Y4	Half-Wave Rectifier Heater Tap for Pilot	12C	5AL	35.0	0.15	With Capacitive-Input Filter
35Z3	Half-Wave Rectifier	12C	4Z	35.0	0.15	With Capacitive-Input Filter
35Z4GT	Half-Wave Rectifier	13D	5AA	35.0	0.15	With Capacitive-Input Filter
36	Sharp-Cutoff Tetrode	24B	5E	6.3	0.3	Screen-Grid RF Amplifier
36AM3	Half-Wave Rectifier	5D	5BQ	36.0	0.1	With Capacitive-Input Filter
36AM3A	Half-Wave Rectifier	5D	5BQ 5BQ	36.0 36.0 $\oplus$	0.1 0.1	With Capacitive-Input Filter
37	Medium-Mu Triode	22 or 13H	5A	6.3	0.3	Class A Amplifier
38	Power Pentode	24B	5F	6.3	0.3	Class A Amplifier
39/44	Remote-Cutoff Pentode	24B	5F	6.3	0.3	Class A Amplifier

Plate Supply Volts	Grid Bias or Cathode Resistor Volts (V) or Ohms (Ω)	Grid Supply Volts	Grid Current mA	Plate Current mA	AC Plate Resistance Ohms	Trans-conductance Micromhos	Amplification Factor	Load for Stated Power Output Ohms	Power Output Watts	RCA Type
Max. DC Plate Volts, 700 Max. DC Cathode mA, 200					Max. Peak Positive-Pulse Plate Volts, 700 (Abs.) Max. Plate Dissipation 10 watts.					<b>25EC6</b>
110	— 7.5V	110	4	49	13000	9000	—	2000	2.1	<b>25L6</b>
200	— 8V	110	2	50	30000	9500	—	3000	4.3	
For other characteristics, refer to Type 50L6GT										<b>25L6GT</b>
Output Triode: Plate Volts, 180; Plate mA, 46; Load, 4000 ohms Triode: Plate Volts, 100; Grid Volts, 0; A-F Signal Volts (Peak), 29.7; Plate mA, 5.8									3.8	<b>25N6G</b>
Max. Peak Inverse Plate Volts, 3850 (Abs.) Max. Peak Plate mA, 750 Max. DC Plate mA, 125					Max. Peak Heater-Cathode Volts: { -500 (Abs.) +200 DC Component must not exceed 100 volts					<b>25W4GT</b>
Max. DC Output mA per Plate, 75										<b>25Y5</b>
For other ratings, refer to Type 25Z6										<b>25Z5</b>
Max. AC Volts per Plate (RMS), 117 Max. DC Output mA, 75					Min. Total Effective Plate-Supply Impedance: Half-Wave, 30 ohms; Full-Wave, 15 ohms					<b>25Z6</b>
Max. AC Volts per Plate (RMS), 235 Max. DC Output mA per Plate, 75					Min. Total Effect. Supply Imped. per Plate: at 117 volts 15 ohms; at 150 volts, 40 ohms; at 235 volts, 100 ohms					<b>25Z6GT</b>
180	-14.5V	—	—	6.2	7300	1150	8.3	—	—	<b>26</b>
250	-21V	—	—	5.2	9250	975	9.0	—	—	<b>27</b>
For other characteristics, refer to Type 1H4G										<b>30</b>
180	-30V	—	—	12.3	3600	1050	3.8	5700	0.375	<b>31</b>
180 (Max.)	-3V	67.5	0.4	1.7	1.0	650	—	—	—	<b>32</b>
110	-7.5V	110	2.8	30	21500	5500	—	2800	1.2	<b>32ET5</b>
90	-7V	90	2.0	27.0	17000	4800	—	2600	1.0	
Maximum AC Plate Voltage.....					125 Volts, RMS					<b>32L7GT</b>
Maximum DC Output Current.....					60 Milliamperes					
180	-18V	180	5.0	22.0	55000	1750	—	6000	1.4	<b>33</b>
180	-3V min.	67.5	1.0	2.8	1.0	620	—	—	—	<b>34</b>
110	-7.5V	110	3	35	13000	5700	—	2500	1.4	<b>34GD5</b>
250	-3V min.	90	2.5*	6.5	—	1050	—	—	—	<b>35</b>
For other characteristics, refer to Type 35L6GT										<b>35A5</b>
For other characteristics, refer to Type 35C5										<b>35B5</b>
120	1500Ω	—	—	0.8	—	1400	100	—	—	<b>35DZ8</b>
140	180Ω	120	6	45	—	7500	—	2500	2.0	
110	-7.5V	110	3	45	12000	7500	—	2500	1.8	<b>35GL6</b>
For other characteristics, refer to Type 35W4										<b>35Y4</b>
For other ratings, refer to Type 35Z5GT										<b>35Z3</b>
Max. DC Output mA, 100					Min. Total Effective Plate-Supply Impedance: Up to 117 volts, 15 ohms; at 235 volts, 100 ohms					<b>35Z4GT</b>
100	-1.5V	55	—	1.8	550000	850	—	—	—	<b>36</b>
250	-3V	90	1.7	3.2	550000	1080	—	—	—	
AC Plate Volts (RMS), 117 Max. DC Output mA, 82					Max. Peak Inverse Volts, 365 Tube Voltage Drop for Plate mA, 150, 20 volts					<b>36AM3</b>
Max. AC Plate Volts (RMS), 120 Max. DC Output mA, 82					Max. Peak Inverse Volts, 365 Tube Voltage Drop for Plate mA, 150, 16 volts					<b>36AM3A</b>
250	-18V	—	—	7.5	8400	1100	9.2	—	—	<b>37</b>
250	-25V	250	3.8	22.0	100000	1200	—	10000	2.50	<b>38</b>
250	{ -3V min. }	90	1.4	5.8	1.0	1050	—	—	—	<b>39/44</b>

RCA Type	Name	Out-line (see p. 513)	Basing Diagram (see p. 488)	Heater or Filament (F)		Use Values to right give operating conditions and characteristics for indicated typical use
				Unless specified all types have heaters.		
				Volts	Amperes	
40	Medium-Mu Triode	9Z	4D	5.0F	0.25	Class A Amplifier
41	Power Pentode	22 or 13H	6B	6.3	0.4	Amplifier
42	Power Pentode	28	6B	6.3	0.7	Amplifier
43	Power Pentode	28	6B	25.0	0.3	Amplifier
45	Power Triode	26	4D	2.5F	1.5	Class A Amplifier
45Z3	Half-Wave Rectifier	5C	5AM	45.0	0.075	Half-Wave Rectifier
45Z5GT	Half-Wave Rectifier Heater Tap for Pilot	13D	6AD Pilot Between Pins 2 and 3	45.0	0.15	With Capacitive-Input Filter
46	Dual-Grid Power Amplifier	27B	5C	2.5F	1.75	Class A Amplifier
47	Power Pentode	27B	5B	2.5F	1.75	Class A Amplifier
48	Power Tetrode	27B	6A	30.0	0.4	Class A Amplifier
49	Dual-Grid Power Amplifier	26	5C	2.0F	0.12	Class A Amplifier
50	Power Triode	29L	4D	7.5F	1.25	Class A Amplifier
50A5	Beam Power Tube	12C	6AA	50.0	0.15	Class A Amplifier
50C6G	Beam Power Tube	25	7AC	50.0	0.15	Single-Tube Class A Amplifier
50FE5	Beam Power Tube	13G	8KB	50.0	0.15	Class A Amplifier
50FK5	Power Pentode	5D	7CV	50.0	0.1	Class A Amplifier
50X6	Rectifier-Doubler	12C	7DX	50.0	0.15	Rectifier-Doubler
50Y6GT	Rectifier-Doubler	13D	7Q	50.0	0.15	Rectifier-Doubler
50Y7GT	Rectifier-Doubler Heater Tap for Pilot	13D	8AN Pilot Between Pins 6 and 7	50.0	0.15	Voltage Doubler
						Half-Wave Rectifier
50Z7G	Rectifier-Doubler Heater Tap for Pilot	22	8AN Pilot Between Pins 6 and 7	50.0	0.15	Voltage Doubler
						Half-Wave Rectifier
53	High-Mu Twin Power Triode	26	7B	2.5	2.0	Amplifier
70L7GT	Rectifier-Beam Power Tube	13F	8AA	70.0	0.15	Amplifier Unit as Class A Amplifier
						Half-Wave Rectifier
75	Twin Diode—High-Mu Triode	24B	6G	6.3	0.3	Amplifier
78	Remote-Cutoff Pentode	24B	6F	6.3	0.3	Amplifier Mixer
80	Full-Wave Rectifier	26	4C	5.0F	2.0	With Capacitive-Input Filter
						With Inductive-Input Filter
84/6Z4	Full-Wave Rectifier	22 or 13H	5D	6.3	0.5	With Capacitive-Input Filter
						With Inductive-Input Filter
117L7 GT/ M7GT	Rectifier-Beam Power Tube	13F	8AO	117	0.09	Amplifier Unit as Class A Amplifier
						Half-Wave Rectifier
117N7 GT	Rectifier-Beam Power Tube	13F	8AV	117	0.09	Amplifier Unit as Class A Amplifier
						Half-Wave Rectifier
117P7 GT	Rectifier-Beam Power Tube	13F	8AV	117	0.09	
117Z3	Half-Wave Rectifier	5D	4CB	117	0.04	With Capacitive-Input Filter

Plate Supply Volts	Grid Bias Volts (V) or Cathode Resistor Ohms (Ω)	Grid Supply Volts	Grid Current mA	Plate Current mA	AC Plate Resistance Ohms	Trans-conductance Micromhos	Amplification Factor	Load for Stated Power Output Ohms	Power Output Watts	RCA Type	
180	— 3V	—	—	0.2	150000	200	30	—	—	40	
For other characteristics, refer to Type 6K6GT										41	
For other characteristics, refer to Type 6F6G										42	
For other characteristics, refer to Type 25A6										43	
275	—56V	—	—	36.0	1700	2050	3.5	4600	2.00	45	
Max. Peak Inverse Volts, 350		Max. DC Output mA, 65			Max. Peak Plate mA, 390					45Z3	
For other ratings, refer to Type 35Z5GT										45Z5GT	
250	—33V	—	—	22	2380	2350	5.6	6400	1.25	46	
250	450Ω	250	6.0	31	60000	2500	—	7000	2.7	47	
125	—20V	100	9.5	56	—	3900	—	1500	2.5	48	
135	—20V	—	—	6.0	4175	1125	4.7	11000	0.17	49	
450	—84V	—	—	55	1800	2100	3.8	4350	4.6	50	
For other characteristics, refer to Type 50L6GT										50A5	
135	—13.5V	135	3.5	58	9300	7000	—	2000	3.6	50C6G	
200	—14V	135	2.2	61	18300	7100	—	2600	6	50C6G	
For other characteristics, refer to Type 6FE5										50FE5	
110	62Ω	115	8.5	32	14000	12800	—	3000	1.2	50FK5	
For other ratings, refer to Type 25Z6GT										50X6	
For other ratings, refer to Type 25Z6GT										50Y6GT	
Max. AC Volts per Plate (RMS), 117				Min. Total Effective Plate-Supply Impedance per Plate, 15 ohms						50Y7GT	
Max. DC Output mA, 65				Min. Total Effect. Plate-Supply Imped. per Plate: At 117 volts, 15 ohms; at 150 volts, 40 ohms; at 235 volts, 100 ohms						50Z7G	
Max. AC Volts per Plate (RMS), 235				Max. DC Output mA per Plate, 65						50Z7G	
Max. DC Output mA, 65				Max. DC Output mA per Plate, 65						50Z7G	
For other characteristics, refer to Type 6N7										53	
110	— 7.5V	110	3.0	40.0	15000	7500	—	2000	1.8	70L7GT	
Max. Peak Inverse Volts, 350		Max. DC Output mA, 70			Max. Peak Plate mA, 420					70L7GT	
Min. Total Effect. Plate-Supply Imped., 15 ohms										75	
For other characteristics, refer to Type 6SQ7										75	
For other characteristics, refer to Type 6K7										78	
AC Volts per Plate (RMS), 350				DC Output mA, 125				Min. Total Effect. Supply Imped. per Plate, 50 ohms			80
Max. Peak Inverse Volts, 1400				Max. Peak Plate mA, 440				Min. Value of Input Choke, 10 henries			80
AC Volts per Plate (RMS), 500				Max. DC Output mA, 125				Total Effect. Supply Imped. per Plate, 150 ohms			84/6Z4
Max. Peak Inverse Volts, 1400				Max. Peak Plate mA, 440				Value of Input Choke, 10 henries			84/6Z4
AC Volts per Plate (RMS), 325				DC Output mA, 60				Total Effect. Supply Imped. per Plate, 150 ohms			84/6Z4
Max. Peak Inverse Volts, 1250				Max. Peak Plate mA, 180				Value of Input Choke, 10 henries			84/6Z4
AC Volts per Plate (RMS), 450				Max. DC Output mA, 60				Value of Input Choke, 10 henries			84/6Z4
Max. Peak Inverse Volts, 1250				Max. Peak Plate mA, 180				Value of Input Choke, 10 henries			84/6Z4
105	— 5.2V	105	4	43	17000	5300	—	4000	0.85	117L7GT/M7GT	
Max. AC Plate Volts (RMS), 117				Max. DC Output mA, 75				Min. Total Effect. Plate-Supply Imped., 15 ohms			117L7GT/M7GT
Max. Peak Inverse Volts, 350				Max. Peak Plate mA, 450				Min. Total Effect. Plate-Supply Imped., 15 ohms			117L7GT/M7GT
100	— 6V	100	5	51	16000	7000	—	3000	1.2	117N7GT	
Max. AC Plate Volts (RMS), 117				Max. DC Output mA, 75				Min. Total Effect. Plate-Supply Impedance, 15 ohms			117N7GT
Max. Peak Inverse Volts, 350				Max. Peak Plate mA, 450				Min. Total Effect. Plate-Supply Impedance, 15 ohms			117N7GT
For other characteristics, refer to Type 117L7/M7GT										117P7GT	
Max. Peak Inverse Volts, 330				Max. DC Output mA, 90				Min. Total Effect. Plate-Supply Imped., 20 ohms			117Z3
				Max. Peak Plate mA, 540							117Z3

RCA Type	Name	Out- line (see p. 513)	Basing Dia- gram (see p. 488)	Heater or Filament (F)		Use Values to right give operat- ing conditions and charac- teristics for indicated typical use
				Unless specified all types have heaters. ⊖ Heater with con- trolled warmup time.		
				Volts	Amperes	
11774 GT	Half-Wave Rectifier	29F	5AA	117	0.04	With Capacitive-Input Filter
11726 GT	Rectifier-Doubler	13D	7Q	117	0.075	Voltage Doubler
						Half-Wave Rectifier
7027	Beam Power Tube	19F	8HY	6.3	0.9	Push-Pull Class AB <sub>1</sub> Amplifier
						Push-Pull Class AB <sub>1</sub> Amplifier
7247	Dual Triode	6B	9A	12.6	0.15	Unit No. 1 as Class A Amplifier
				6.3	0.3	Unit No. 2 as Class A Amplifier
7591	Beam Power Tube	13D	8KQ	6.3	0.8	Class A Amplifier
						Push-Pull Class AB <sub>1</sub> Amplifier
7695	Beam Power Tube	13D	9PX	50	0.15	Class A Amplifier
						Push-Pull Class AB <sub>1</sub> Amplifier
EM84/ 6FG6	Electron-Ray Tube	6F	96A	6.3	0.27	Visual Indicator

□ For two tubes.

Types shown in light face are discontinued.



Plate Supply Volts	Grid Bias Volts (V) or Cathode Resistor Ohms ( $\Omega$ )	Grid Supply Volts	Grid Current mA	Plate Current mA	AC Plate Resistance Ohms	Trans-conductance Micromhos	Amplification Factor	Load for Stated Power Output Ohms	Power Output Watts	RCA Type	
Max. Peak Inverse Volts, 350				Max. DC Output mA, 90 Max. Peak Plate mA, 540			Min. Total Effect. Plate-Supply Imped., 30 ohms			11724 GT	
AC Volts per Plate (RMS), 117 DC Output mA, 60			Min. Total Effective Plate-Supply Impedance per Plate: Half-Wave, 30 ohms; Full-Wave, 15 ohms								11726 GT
AC Volts per Plate (RMS), 235 DC Output mA per Plate, 60			Min. Total Effect. Supply Imped. per Plate: At 117 volts, 15 ohms; at 150 volts, 40 ohms; at 235 volts, 100 ohms								
450	—30V	350	3.4□	95□	—	—	—	6000	50	7027	
400	200 $\Omega$	300	7□	112□	—	—	—	6600	32		
380	180 $\Omega$	380	5.6□	138□	—	—	—	4500	36		
410	220 $\Omega$	—	Cath. mA, 134		—	—	—	8000	24		
250	—2V	—	—	1.2	62500	1600	100	—	—	7247	
250	—8.5V	—	—	10.5	7700	2200	17	—	—		
300	—10V	300	8	60	29000	10200	—	3000	11	7591	
450	200 $\Omega$	400	11.5	82	—	—	—	9000	28†		
130	—11V	130	5	100	7000	11000	—	1100	4.5	7695	
140	50 $\Omega$	140	9	210	—	—	—	1500	10†		
Triode Plate Supply Volts, 250 Triode-Plate Resistance, 1 M $\Omega$ Triode Grid-Supply Volts, —22 Max. Length of Dark Part of Target, when triode grid resistor = 0, 1.14 inch							Fluorescent-Target Volts, 250 Triode-Grid Resistance, 0.47 M $\Omega$ Fluorescent Target mA, 1.6				EM84/ 6FG6

† For two tubes at stated plate-to-plate load.

# Basing Diagrams for RCA Replacement and Discontinued Types

## LEGEND FOR BASE AND ENVELOPE CONNECTION DIAGRAMS

Bottom Views

Subscripts B, D, HP, HX, P, T, and TR indicate, respectively, beam unit, diode unit, heptode unit, hexode unit, pentode unit, triode unit, and tetrode unit in multi-unit types.

- |                                  |  |  |                                   |
|----------------------------------|--|--|-----------------------------------|
| <b>BC</b> - Base Sleeve          | <b>FT</b> - Fluorescent Target           | <b>HS</b> - Heater Shield                      | <b>P.</b> - Plate (Anode)         |
| <b>BS</b> - Base Shell           | <b>G</b> - Grid                          | <b>IC</b> - Internal Connection-<br>Do Not Use | <b>RC</b> - Ray-Control Electrode |
| <b>DJ</b> - Deflecting Electrode | <b>H</b> - Heater                        | <b>IS</b> - Internal Shield                    | <b>S</b> - Shell                  |
| <b>ES</b> - External Shield      | <b>HL</b> - Heater Tap for<br>Panel Lamp | <b>K</b> - Cathode                             | <b>TA</b> - Target                |
| <b>F</b> - Filament              | <b>HM</b> - Heater Mid-Tap               | <b>NC</b> - No Connection                      | <b>U</b> - Unit                   |
| <b>FM</b> - Filament Mid-Tap     |  |  | <b>●</b> - Gas-Type Tube          |

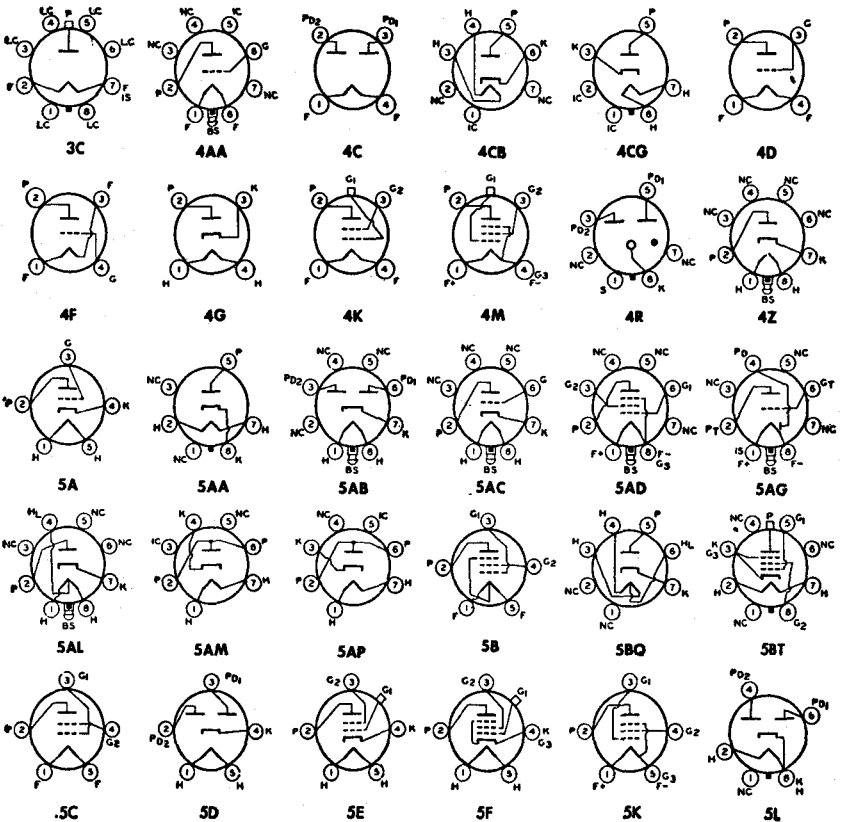

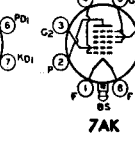
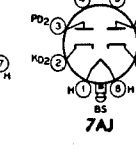
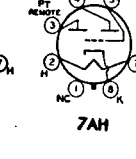
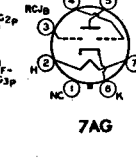
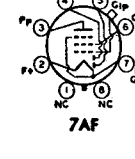
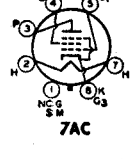
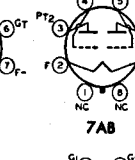
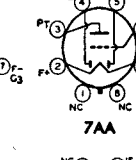
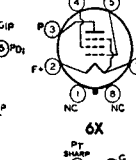
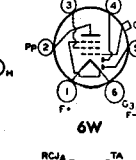
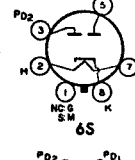
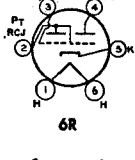
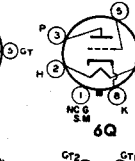
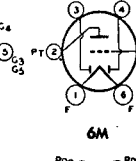
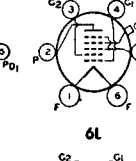
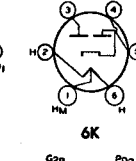
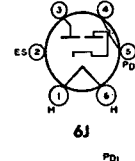
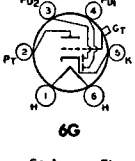
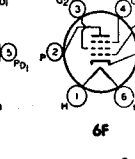
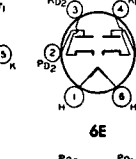
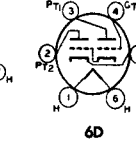
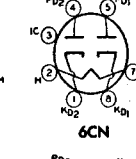
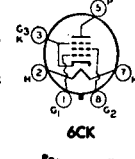
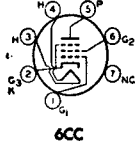
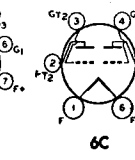
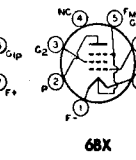
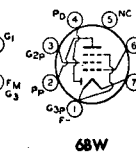
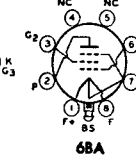
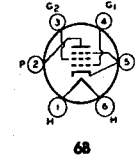
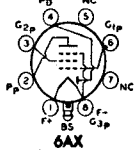
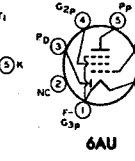
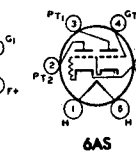
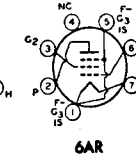
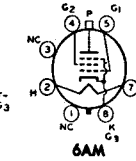
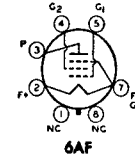
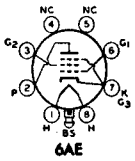
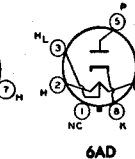
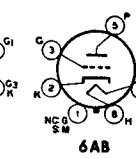
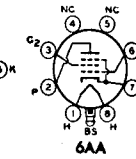
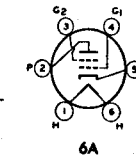
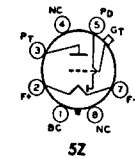
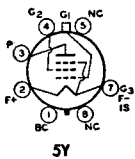
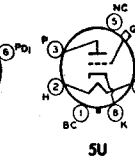
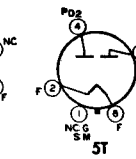
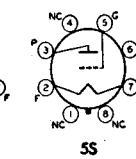
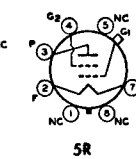
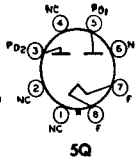
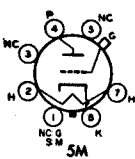

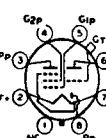
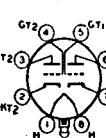
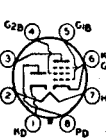
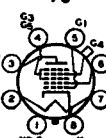
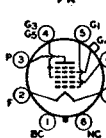
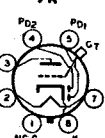
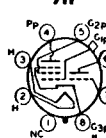
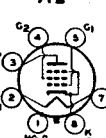
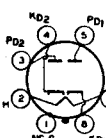
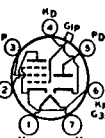
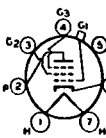
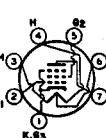
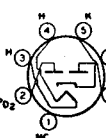
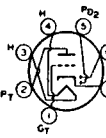
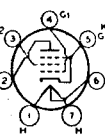
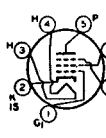
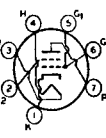
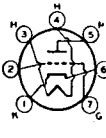
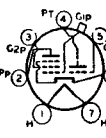
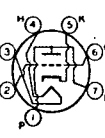
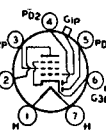
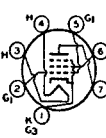
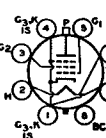
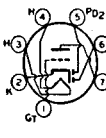
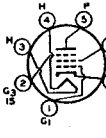
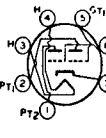
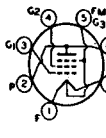
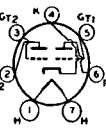
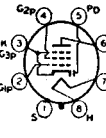
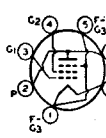
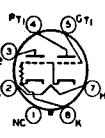
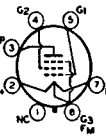
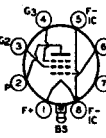
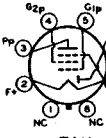

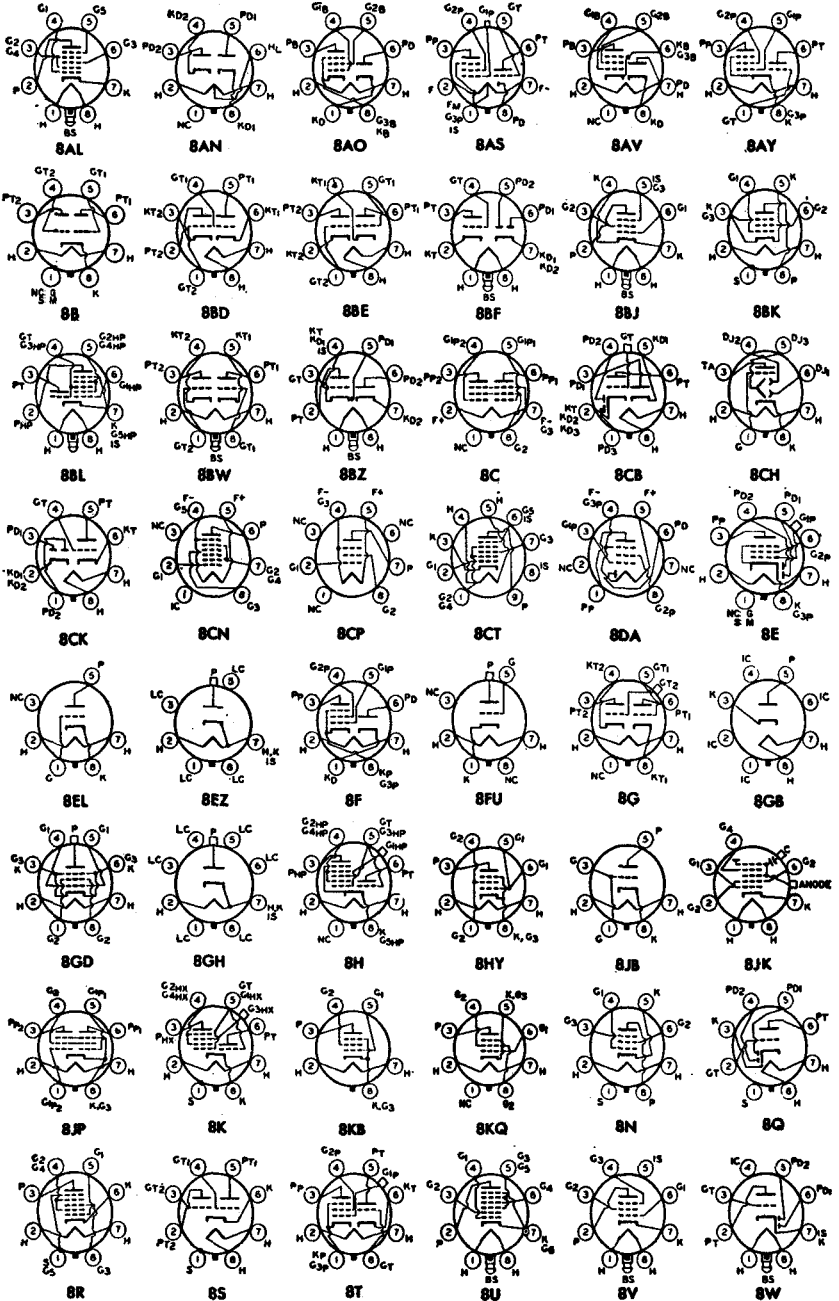

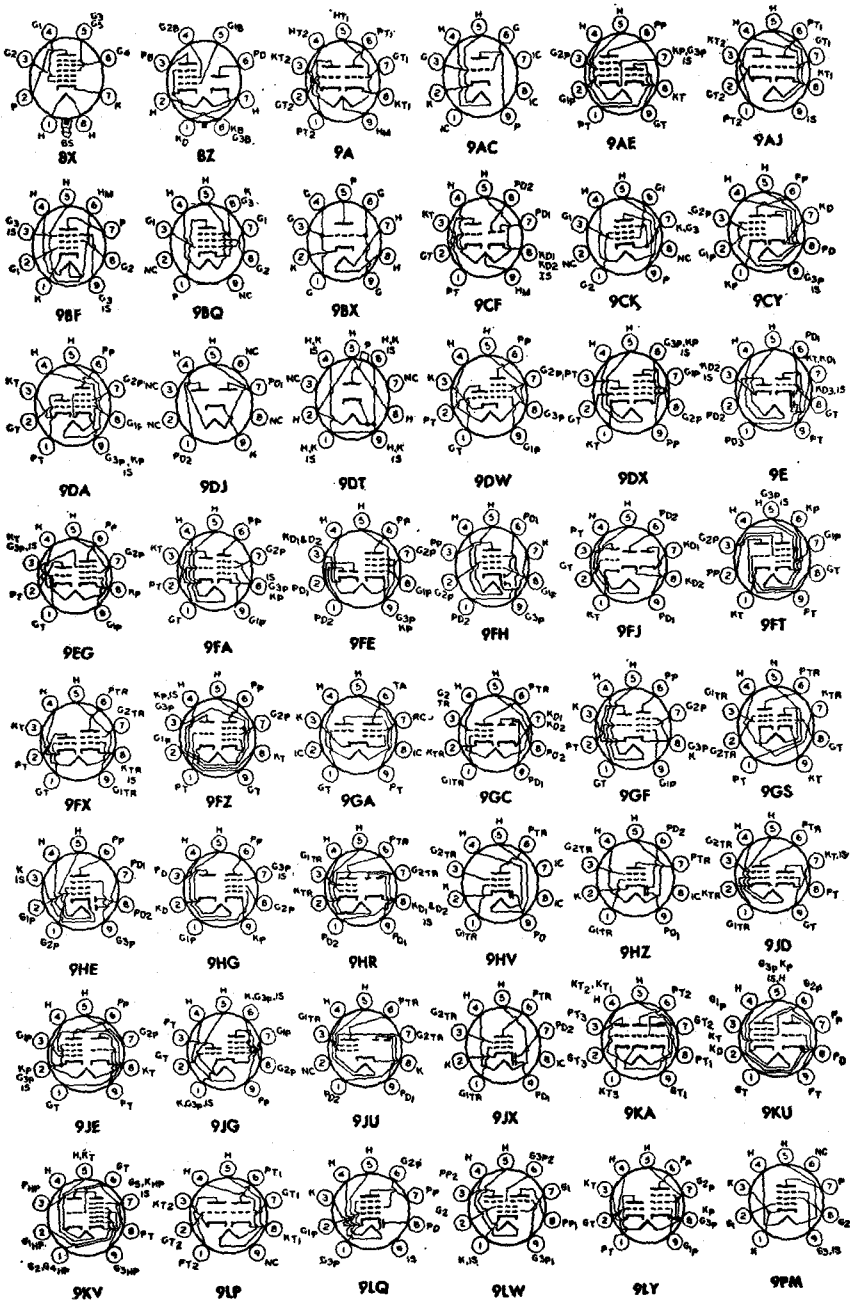

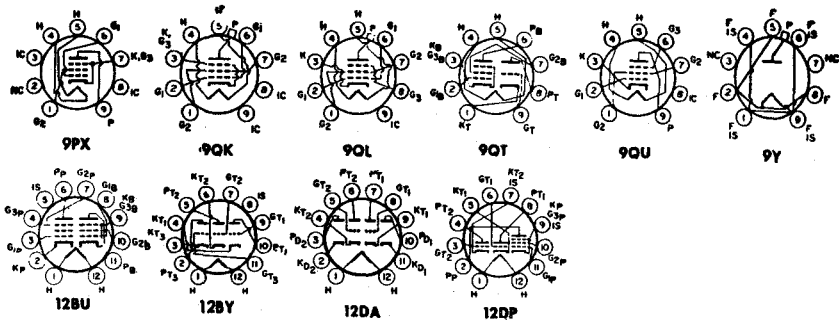

**BASING DIAGRAMS FOR RCA PICTURE TUBES**

(See page 495 for data.)

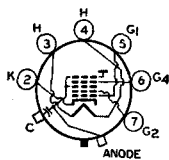

**7FA**  
 ANODE = G<sub>3</sub> + G<sub>2</sub> + CL  
 FOCUSING ELECTRODE = G<sub>4</sub>

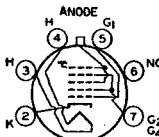

**7FG**  
 ANODE = G<sub>3</sub> + G<sub>5</sub> + CL  
 AUTOMATIC FOCUSING

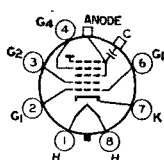

**8HR**  
 ANODE = G<sub>3</sub> + G<sub>5</sub> + CL  
 FOCUSING ELECTRODE = G<sub>4</sub>

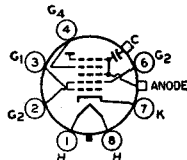

**8JK**  
 ANODE = G<sub>3</sub> + G<sub>5</sub> + CL  
 FOCUSING ELECTRODE = G<sub>4</sub>

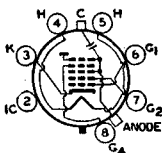

**8KP**  
 ANODE = G<sub>3</sub> + G<sub>5</sub> + CL  
 FOCUSING ELECTRODE = G<sub>4</sub>

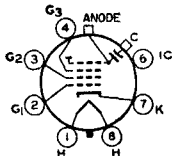

**8JR**  
 ANODE = G<sub>4</sub> + CL  
 FOCUSING ELECTRODE = G<sub>3</sub>

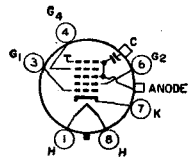

**8KW**  
 ANODE = G<sub>3</sub> + G<sub>5</sub> + CL  
 FOCUSING ELECTRODE = G<sub>4</sub>

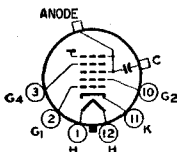

**12AB**  
 ANODE = G<sub>3</sub> + G<sub>5</sub> + CL  
 FOCUSING ELECTRODE = G<sub>4</sub>

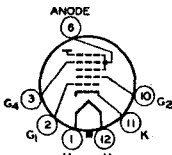

**12AD**  
 ANODE = G<sub>3</sub> + G<sub>5</sub> + CL  
 FOCUSING ELECTRODE = G<sub>4</sub>

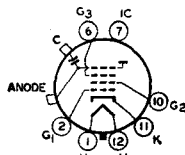

**12C**  
 ANODE = G<sub>4</sub> + CL  
 FOCUSING ELECTRODE = G<sub>3</sub>

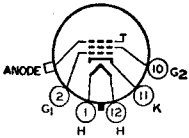

12D  
ANODE = G<sub>3</sub> + C1

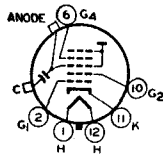

12L  
ANODE = G<sub>3</sub> + G<sub>5</sub> + C1  
FOCUSING ELECTRODE = G<sub>4</sub>

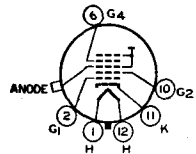

12M  
ANODE = G<sub>3</sub> + G<sub>4</sub> + C1  
FOCUSING ELECTRODE = G<sub>4</sub>

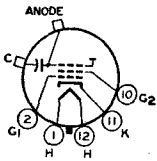

12N  
ANODE = G<sub>3</sub> + C1

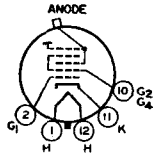

12S  
ANODE = G<sub>3</sub> + G<sub>5</sub> + C1  
AUTOMATIC FOCUSING

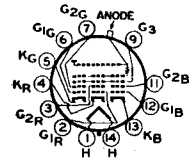

14AH  
ANODE = G<sub>4</sub> + G<sub>5</sub> + C1 + R  
FOCUSING ELECTRODE = G<sub>3</sub>

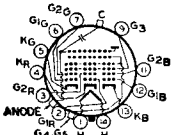

14AL

(14AL)  
CAP OVER PIN No. 1  
= G<sub>4</sub> + G<sub>5</sub>  
CAP OVER PIN No. 2 - ANODE  
= G<sub>6</sub> + C1 & HIGH-VOLTAGE  
TERMINAL. Connect High-Voltage  
Supply to this Cap and also  
connect 50,000-ohm resistor  
between this Cap and the Cap  
over Pin No. 1.  
FOCUSING ELECTRODE = G<sub>3</sub>

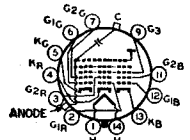

14AU  
ULTOR = G<sub>4</sub> + G<sub>5</sub> + C1  
FOCUSING ELECTRODE = G<sub>3</sub>

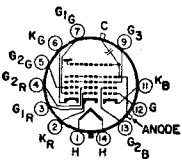

14BE  
ANODE = G<sub>2</sub> + G<sub>4</sub> + C1  
FOCUSING ELECTRODE = G<sub>3</sub>

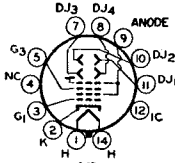

14Z  
ANODE = G<sub>2</sub> + G<sub>4</sub> + C1  
FOCUSING ELECTRODE = G<sub>3</sub>

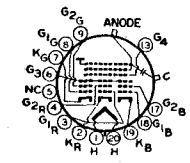

20A  
ANODE = G<sub>2</sub> + G<sub>4</sub> + C1  
FOCUSING ELECTRODE = G<sub>3</sub>



## RCA PICTURE TUBE CHARACTERISTICS CHART

RCA Type	Aluminized Screen	Heater Volts/mA	Envelope*	Greatest Deflection Angle <sup>b</sup> (Approx.) Degrees	Focusing Method	Approx. Tube Weight Pounds	Maximum Over-all Length Inches	Basing*	Design Maximum Anode <sup>c</sup> Volts	PM Ion-Trap Magnet Required
<b>Silverama Types for Black-and-White TV</b>										
5TP4 <sup>d</sup>	Yes	6.3/600	● G	50	E	1.2	12.12	12C	29500	No
7JP4	No	6.3/600	● G	(e)	E	3	14.88	14R	6500	No
8DP4	No	6.3/600	■ G	90	E	3	10.750	12AB	9000	Yes
9QP4A	No	4.7/300	■ G	70	E	3.5	13.062	12AD	7500	Yes
10BP4A	No	6.3/600	● G	50	M	10	18	12N	12000	Yes
10FP4A	Yes	6.3/600	● G	50	M	10	18	12N	13000	No
12BNP4A	Yes	6.3/450	■ G	110	E	5	9.598	8HR	15000	No
12KP4A	Yes	6.3/600	● G	54	M	12	18	12N	13000	No
14ATP4	Yes	8.4/450	■ G	90	E	8.5	13.500	12L	15500	No
14CP4B	Yes	6.3/600	■ G	70	M	10.5	16.844	12N	15500	No
14WP4	Yes	6.3/600	■ G	90	E	8.5	13.500	12L	15500	No
16ANP4	Yes	6.3/600	■ G <sup>q</sup>	114	E	8.5	10.75	8HR	18000	No
16AP4A	No	6.3/600	● M	53	M	11	22.31	12D	15500	Yes
16AYP4	Yes	6.3/450	■ G	114	E	8.5	10.561	8HR	20000	No
16BP4	Yes	6.3/450	■ G <sup>m</sup>	114	E	8.5	10.50	8HR	20000	No
16DP4A	No	6.3/600	● G	60	M	15	21	12D	16500	Yes
16GP4B	No	6.3/600	● M	70	M	11	17.69	12D	15500	Yes
16LP4A	No	6.3/600	● G	52	M	14.5	22.625	12N	15500	Yes
16RP4B	Yes	6.3/600	■ G	70	M	16	19.125	12N	17500	No
16TP4	No	6.3/600	■ G	70	M	16	18.50	12N	15500	Yes
16WP4A	No	6.3/600	● G	70	M	16.5	18.125	12N	17500	Yes
17BJP4	Yes	6.3/600	■ G	90	E	15	15	12L	17500	No
17BP4D	Yes	6.3/600	■ G	70	M	18	19.56	12N	17500	No
17CDP4	Yes	8.4/450	■ G	110	E	10	12.812	8HR	17500	No
17CFP4	Yes	6.3/600	■ G	90	E	10	15.38	12L	17500	No
17CP4	No	6.3/600	■ M	70	M	10	19	12D	17500	Yes
17CSP4	Yes	6.3/600	■ G	110	E	10	12.62	7FA	17500	No
17CYP4	Yes	6.3/600	■ G	90	E	10	14.38	12L	17500	No
17DAP4	Yes	2.68/450	■ G	110	E	10	10.875	8JK	17500	No
17DKP4	Yes	6.3/600	■ G	110	E	10	10.94	8JR	23000	No
17DQP4 <sup>r</sup>	Yes	6.3/450	■ G	110	E	10	12.38	7FA	17500	No
17DRP4 <sup>r</sup>	Yes	2.68/450	■ G	110	E	10	11	8JK	17500	No
17DSP4	Yes	6.3/600	■ G	110	E	10	11.44	8HR	20000	No
17DXP4	Yes	6.3/450	■ G	110	E	10	10.94	8JR	17500	No
17EFP4	Yes	6.3/450	■ G	110	E	10	11.437	8HR	20000	No
17GP4	No	6.3/600	■ M	70	E	10	19.31	12M	17500	Yes
17HP4C	Yes	6.3/600	■ G	70	E	18	19.56	12L	17500	No
17LP4B	Yes	6.3/600	■ G <sup>h</sup>	70	E	19	19.56	12L	17500	No
17QP4B	Yes	6.3/600	■ G <sup>a</sup>	70	M	19	19.56	12N	20000	No
17TP4	No	6.3/600	■ M	70	E	10	19.31	12M	17500	Yes
19ABP4	Yes	2.68/450	■ G	114	E	14	11.125	8JK	20000	No
19ANP4	Yes	6.3/450	■ G	114	E	13.5	11.625	8HR	17500	No
19AJP4 <sup>r</sup>	Yes	6.3/450	■ G	114	E	14	11.62	7FA	20000	No
19AP4B	No	6.3/600	● M	66	M	14	22	12D	17500	Yes
19AUP4	Yes	6.3/600	■ G <sup>j</sup>	114	E	18.5	11.94	8HR	20000	No
19AVP4	Yes	6.3/600	■ G	114	E	14	11.62	8HR	23000	No

\* Basing diagrams for RCA picture tubes are shown on page 493.

## RCA PICTURE TUBE CHARACTERISTICS CHART (Cont'd)

RCA Type	Aluminized Screen	Heater Volts/mA	Envelope <sup>a</sup>	Greatest Deflection Angle <sup>b</sup> (Approx.) Degrees	Focusing Method	Approx. Tube Weight Pounds	Maximum Over-all Length Inches	Basing <sup>*</sup>	Design Maximum Anode <sup>c</sup> Volts	PM Ion-Trap Magnet Required
<b>19AYP4</b>	Yes	6.3/450	■ G	114	E	14	11.62	8HR	23000	No
<b>19BDP4<sup>f</sup></b>	Yes	6.3/600	■ G	92	E	15	15.625	12L	20000	No
<b>19BTP4</b>	Yes	6.3/600	■ G	114	E	14	11.06	8JR	23000	No
<b>19CHP4<sup>f</sup></b>	Yes	6.3/600	■ G	114	E	14	11.88	8HR	20000	No
<b>19CMP4<sup>f</sup></b>	Yes	6.3/450	■ G	114	E	14	11.88	8HR	20000	No
<b>19CXP4<sup>f</sup></b>	Yes	6.3/600	■ G	114	E	14	11.875	7FA	20000	No
<b>19DAP4</b>	Yes	6.3/450	■ G <sup>vk</sup>	114	E	14	11.87	8HR	23000	No
<b>19DQP4</b>	Yes	6.3/450	■ G <sup>m</sup>	114	E	15	11.875	8HR	23000	No
<b>19DRP4</b>	Yes	6.3/600	■ G <sup>m</sup>	114	E	14	11.875	8HR	23000	No
<b>19DSP4<sup>f</sup></b>	Yes	6.3/600	■ G <sup>m</sup>	114	E	14	11.875	8HR	20000	No
<b>20DP4D</b>	Yes	6.3/600	■ G	70	M	30	20.375	12N	20000	No
<b>20HP4E</b>	Yes	6.3/600	■ G	70	E	30	22.62	12L	17500	No
<b>21AMP4B</b>	Yes	6.3/600	■ G	90	M	24	23.41	12N	20000	No
<b>21AP4</b>	No	6.3/600	■ M	70	M	18	22.12	12D	20000	Yes
<b>21AVP4C</b>	Yes	6.3/600	■ G	72	E	24	22.12	12L	22000	No
<b>21AWP4A</b>	Yes	6.3/600	■ G	72	M	24	23.41	12N	20000	No
<b>21CBP4A</b>	Yes	6.3/600	■ G	90	E	24	18.375	12L	22000	No
<b>21CQP4</b>	Yes	6.3/600	■ G	110	E	20	14.81	7FA	20000	No
<b>21DEP4A</b>	Yes	6.3/600	■ G	110	E	20	15	8HR	22000	No
<b>21DFP4</b>	Yes	6.3/600	■ G	110	E	24	14.750	8HR	20000	No
<b>21DHP4</b>	Yes	6.3/450	■ G	110	E	20	15	8HR	20000	No
<b>21DLP4</b>	Yes	6.3/600	■ G	90	E	24	17.375	12L	22000	No
<b>21DSP4<sup>f</sup></b>	Yes	6.3/600	■ G	90	E	24	18.375	12L	22000	No
<b>21EP4C</b>	Yes	6.3/600	■ G <sup>h</sup>	70	M	29	23.41	12N	20000	No
<b>21EQP4</b>	Yes	6.3/600	■ G	110	E	24	12.88	8JR	20000	No
<b>21EVP4<sup>f</sup></b>	Yes	2.68/450	■ G	110	E	20	13.19	8JK	20000	No
<b>21FAP4</b>	Yes	6.3/600	■ G	110	E	20	13.12	8JR	22000	No
<b>21FDP4</b>	Yes	6.3/600	■ G	110	E	20	13.38	8KW	20000	No
<b>21FP4D</b>	Yes	6.3/600	■ G <sup>h</sup>	70	E	29	23.41	12L	20000	No
<b>21FVP4</b>	Yes	6.3/450	■ G <sup>m</sup>	114	E	19	12.937	8HR	23000	No
<b>21MP4</b>	No	6.3/600	■ M	70	E	18	22.62	12M	17500	Yes
<b>21WP4B</b>	Yes	6.3/600	■ G	70	M	18	22.812	12N	20000	No
<b>21XP4B</b>	Yes	6.3/600	■ G	70	E	18	22.812	12L	20000	No
<b>21YP4B</b>	Yes	6.3/600	■ G	70	E	24	23.41	12L	20000	No
<b>21ZP4C</b>	Yes	6.3/600	■ G	70	M	24	23.41	12N	20000	No
<b>23AHP4</b>	Yes	6.3/600	■ G	92	E	25	18.38	12L	22000	No
<b>23ARP4</b>	Yes	6.3/600	■ G	110	E	25	15.156	8HR	22000	No
<b>23ASP4</b>	Yes	6.3/600	■ G	92	E	25	17.38	12L	22000	No
<b>23BGP4<sup>f</sup></b>	Yes	6.3/600	■ G <sup>j</sup>	110	E	25	15.562	8HR	22000	No
<b>23BJP4<sup>f</sup></b>	Yes	6.3/600	■ G	92	E	33	18.50	12L	25000	No
<b>23BLP4<sup>f</sup></b>	Yes	6.3/600	■ G <sup>jk</sup>	92	E	35	18.88	12L	25000	No
<b>23BQP4</b>	Yes	6.3/450	■ G <sup>j</sup>	110	E	33	15.562	8HR	23000	No
<b>23CBP4</b>	Yes	6.3/450	■ G <sup>jk</sup>	110	E	33	15.56	8HR	23000	No
<b>23CGP4</b>	Yes	6.3/450	■ G	92	E	25	18.375	12L	22000	No
<b>23CP4</b>	Yes	6.3/600	■ G <sup>j</sup>	110	E	33	15.56	8HR	22000	No
<b>23CQP4</b>	Yes	6.3/450	■ G	114	E	25	14.062	8HR	23500	No

\* Basing diagrams for RCA picture tubes are shown on page 493.

RCA PICTURE TUBE CHARACTERISTICS CHART (Cont'd)

RCA Type	Aluminized Screen	Heater Volts/mA	Envelope <sup>a</sup>	Greatest Deflection Angle <sup>b</sup> (Approx.) Degrees	Focusing Method	Approx. Tube Weight Pounds	Maximum Over-all Length Inches	Basing <sup>c</sup>	Design Maximum Anode <sup>c</sup> Volts	PM Ion-Trap Magnet Required
<b>Silverara Types for Black-and-White TV</b>										
23DAP4'	Yes	6.3/600	■ G	94	E	27	17.39	8HR	23000	No
23DBP4'	Yes	6.3/600	■ G	110	E	25	15.156	8HR	22000	No
23ENP4	Yes	6.3/600	■ G <sup>m</sup>	92	E	29	18.500	12L	25000	No
23EP4'	Yes	6.3/600	■ G <sup>j</sup>	110	E	33	15.562	8KP	22000	No
23EQP4	Yes	6.3/450	■ G <sup>m</sup>	114	E	25	14.812	8HR	23000	No
23ETP4	Yes	6.3/600	■ G <sup>m</sup>	110	E	25	15.156	8HR	23000	No
23FBP4	Yes	6.3/600	■ G <sup>km</sup>	92	E	29	18.500	12L	25000	No
23FP4A	Yes	6.3/600	■ G	114	E	25	14.062	8HR	23500	No
23JP4'	Yes	6.3/450	■ G <sup>j</sup>	110	E	33	15.88	7FA	22000	No
23NP4'	Yes	6.3/600	■ G	114	E	25	14.812	8HR	22000	No
23YP4	Yes	6.3/600	■ G <sup>j</sup>	92	E	35	18.75	12L	22000	No
24AEP4	Yes	6.3/600	■ G	90	E	35	19.500	12L	22000	No
24ANP4	Yes	6.3/600	■ G	110	E	28	16.188	8HR	22000	No
24ATP4'	Yes	6.3/600	■ G	90	E	35	19.500	12L	22000	No
24AUP4	Yes	6.3/600	■ G	90	E	35	18.50	12L	22000	No
24BAP4'	Yes	6.3/600	■ G	110	E	28	16.188	8HR	22000	No
24BEP4	Yes	6.3/600	■ G	110	E	28	15.12	8KW	20000	No
24CP4B	Yes	6.3/600	■ G	90	M	35	21.50	12N	22000	No
27MP4	Yes	6.3/600	■ M	90	M	30	22.19	12D	20000	Yes
27RP4A	Yes	6.3/600	■ G	90	M	44	23.44	12N	22000	No

Color Picture Tubes

15GP22 <sup>n</sup>	Yes	6.3/1800 <sup>p</sup>	● G	45	E	25	26.12	20A	22000	No
21AXP22A	Yes	6.3/1800 <sup>p</sup>	● M	70	E	28	25.31	14AH	27500	No
21CYP22A	Yes	6.3/1800 <sup>p</sup>	● G	70	E	36.5	25.406	14AL	27500	No
21FBP22	Yes	6.3/1800 <sup>p</sup>	● G	70	E	36.5	25.406	14AU	27500	No
21FBP22A	Yes	6.3/1800	● G	70	E	36.5	25.406	14AU	27500	No
21FJP22	Yes	6.3/1800 <sup>p</sup>	● G <sup>kq</sup>	70	E	41	25.594	14AU	27500	No
21FJP22A	Yes	6.3/1800	● G <sup>kq</sup>	70	E	41	25.594	14AU	27500	No
25AP22A	Yes	6.3/800 <sup>r</sup>	■ G <sup>kq</sup>	90	E	42	20.375	14BE	27500	No

Test Picture Tubes

5AXP4	No	6.3/600	● G	53	E <sup>*</sup>	1.5	11.00	12S	20000	No
8XP4	Yes	6.3/600	■ G	90	E <sup>*</sup>	3	11.75	12S	22000	No
8YP4	Yes	6.3/600	■ G	110	E <sup>*</sup>	2	9	7FG	22000	No

\* Basing diagrams for RCA picture tubes are shown on page 493.

- G Glass round.
- M Metal round.
- G Glass rectangular.
- M Metal rectangular.
- E Electrostatic.
- M Magnetic.
- a Faceplate is spherical, unless otherwise specified.
- b All types utilize magnetic deflection except for type 7JP4 which employs electrostatic deflection.
- c The anode is defined as the electrode, or the electrode in combination with one or more additional electrodes connected within the tube

- to it, to which is applied the highest dc voltage for accelerating the electrons in the beam.
- d Projection type.
- e Typical deflection factors (volts dc/in.) for anode voltage of 6000 volts: DJ1 & DJ2 (nearer screen) 186 to 246 DJ3 & DJ4 (nearer base) 150 to 204
- f Has low grid-No.2 voltage rating: for Cathode-Drive Service.
- g This type has an internal magnetic shield.

- h Cylindrical faceplate.
- j Bipanel type.
- k Treated to reduce specular reflection.
- m PAN-O-PLY—integral implosion protection.
- n This type has a flat, aluminized, filterglass phosphor-dot screen plate.
- p Three heaters paralleled internally.
- q This type has an integral protective window.
- r Three heaters series connected internally.
- s Automatic.

## RCA VOLTAGE-REGULATOR AND VOLTAGE-REFERENCE TUBES

*These tubes are designed for voltage-regulation requiring a relatively constant dc output voltage across a load independent of load and line-voltage variations.*

RCA Type	DC Operating Volts	DC Operating Current Range mA	Anode Starting Volts	Anode Starting (mA)	Regulation Volts	Ambient Operating Temperature Range (°C)	Max Length (in)	Max Diameter (in)	Diagram Terminal
<b>VOLTAGE-REGULATOR TUBES †</b>									
0A2	150	5 to 30	185	75	6	-55 to +90	2-5/8	3/4	5B0
0A3	75	5 to 40	105	100	6.5	-55 to +90	4-1/8	1-9/16	4A1
0A3A	75	5 to 40	105	100	6.5	-55 to +90	3-1/16	1-9/32	4A1
0B2	105	5 to 30	133	75	4	-55 to +90	2-5/8	3/4	5B0
0C2	75	5 to 30	115	75	4.5	-55 to +90	2-5/8	3/4	5B0
0C3	105	5 to 40	133	100	4	-55 to +90	4-1/8	1-9/16	4A1
0C3A	105	5 to 40	127	100	4	-55 to +90	3-1/16	1-9/32	4A1
0D3	150	5 to 40	185	100	5.5	-55 to +90	4-1/8	1-9/16	4A1
0D3A	150	5 to 40	180	100	5.5	-55 to +90	3-1/16	1-9/32	4A1
991	59	0.4 to 2	87	—	8	—	1-9/16	5/8	*
6073	150	5 to 30	185	75	6	-55 to +90	2-5/8	3/4	5B0
6073/0A2	150	5 to 30	185	75	6	-55 to +90	2-5/8	3/4	5B0
6074	105	5 to 30	133	75	4	-55 to +90	2-5/8	3/4	5B0
6074/0B2	105	5 to 30	133	75	4	-55 to +90	2-5/8	3/4	5B0
6626/0A2WA	150	5 to 30	165	75	5	-55 to +90	2-5/8	3/4	5B0

### VOLTAGE-REFERENCE TUBES † (for exceptional voltage stability)

5651	87	1.5 to 3.5	115	—	3	-55 to +90	2-1/8	3/4	5B0
5651A	85.5	1.5 to 3.5	115	—	3	-55 to +90	2-1/8	3/4	5B0

### SERIES-VOLTAGE-REGULATOR TUBES \*\* (for high-current applications)

RCA Type	Heater Volts	Heater Amperes	DC Plate Volts	DC Plate Amperes	Plate Dissipation (watts)	Amplification Factor	Plate Resistance (ohms)	Max Length (in)	Max Diameter (in)	Terminal Diagram
6336A	6.3	2.5	250	0.125	13	2	280	4-5/8	1-9/16	8B0
6A57G	6.3	2.5	250	0.125	13	2	280	4-1/6	1-23/32	8B0
6080	26.5	0.6	250	0.125	13	2	280	4-1/6	1-23/32	8B0
6082	6.3	5	400	0.4	30	2.7	280	4-3/4	2.07	8B0

\*\* Indirectly-heated-cathode, vacuum, low- $\mu$  twin triodes.

\* Candelabra two-contact socket.

† Cold-cathode, glow-discharge types.

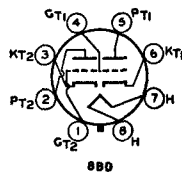
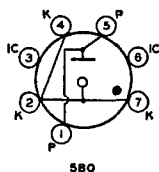
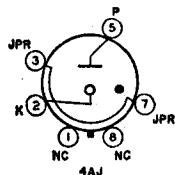

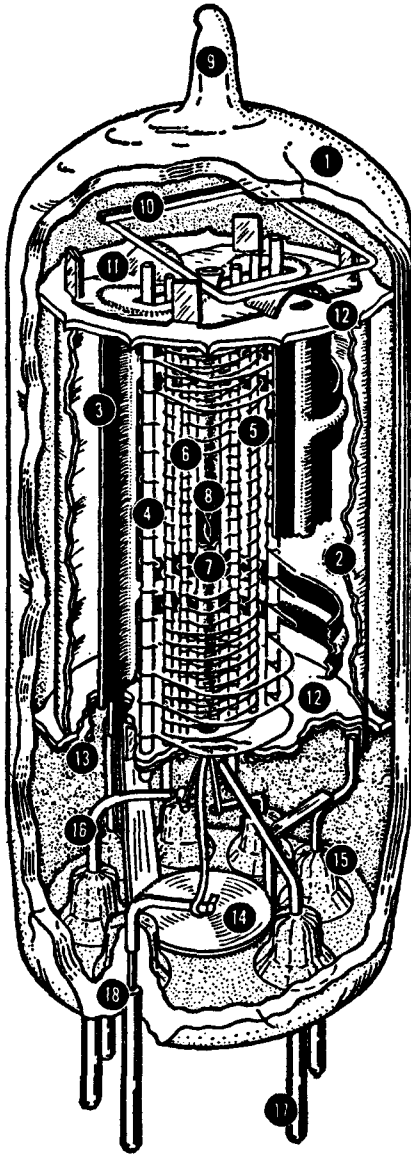

- 1—Glass Envelope
- 2—Internal Shield
- 3—Plate
- 4—Grid No. 3 (Suppressor)
- 5—Grid No. 2 (Screen)
- 6—Grid No. 1 (Control Grid)
- 7—Cathode
- 8—Heater
- 9—Exhaust Tip
- 10—Getter
- 11—Spacer Shield Header
- 12—Insulating Spacer
- 13—Spacer Shield
- 14—Inter-Pin Shield
- 15—Glass Button-Stem Seal
- 16—Lead Wire
- 17—Base Pin
- 18—Glass-to-Metal Seal

**Structure of a Miniature Tube**

# Electron Tube Testing

**T**HE electron-tube user—service man, experimenter, or non-technical radio listener—is interested in knowing the condition of his tubes, since they govern the performance of the device in which they are used. In order to determine the condition of a tube, some method of test is necessary. Because the operating capabilities and design features of a tube are indicated and described by its electrical characteristics, a tube is tested by measuring its characteristics and comparing them with values established as standard for that type. Tubes which read abnormally high with respect to the standard for the type are subject to criticism just the same as tubes which are too low.

Certain practical limitations are placed on the accuracy with which a tube test can be correlated with actual tube performance. These limitations make it impractical for the service man and dealer to employ complex and costly testing equipment having laboratory accuracy. Because the accuracy of the tube-testing device need be no greater than the accuracy of the correlation between test results and receiver performance, and since certain fundamental characteristics are virtually fixed by the manufacturing technique of leading tube manufacturers, it is possible to employ a relatively simple test in order to determine the serviceability of a tube.

In view of these factors, dealers and service men will find it economically expedient to obtain adequate accuracy and simplicity of operation by employing a device which indicates the status of a single characteristic. Whether the tube is satisfactory or unsatisfactory is judged from the test result of this single characteristic. Consequently, it is

very desirable that the characteristic selected for the test be one which is truly representative of the tube's over-all condition.

The following information and circuits are given to describe and illustrate general theoretical and practical tube-tester considerations and not to provide information on the construction of a home-made tube tester. In addition to the problem of determining what tube characteristic is most representative of performance capabilities in all types of receivers, the designer of a home-made tester faces the difficult problem of determining satisfactory limits for his particular tester. Getting information of this nature, if it is to be accurate and useful, is a big job. It requires the testing of many tubes of each type, testing of many types, and correlation of the data with performance in many kinds of equipment.

## Short-Circuit Test

The fundamental circuit of a short-circuit tester is shown in Fig. 106. Although this circuit is suitable for tet-

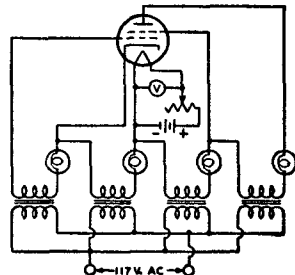

Fig. 106—Fundamental circuit of a short-circuit tester.

rodes and types having less than four electrodes, tubes of more electrodes may be tested by adding more indicator lamps to the circuit. Voltages are applied between the various electrodes with lamps in series with the electrode leads. The value of the voltages applied will depend on the type of tube being tested and its maximum ratings. Any two shorted electrodes complete a circuit and light one or more lamps. Since two electrodes may be just touching to give a high-resistance short, it is desirable that the indicating lamps operate on very low current. It is also desirable to maintain the filament or heater of the tube at its operating temperature during the short-circuit test, because short-circuits in a tube may sometimes occur only when the electrodes are heated. However, a short-circuit tester having too high a sensitivity may indicate very-high-resistance shorts that do not adversely affect tube operation.

### Selection of a Suitable Characteristic for Test

Some characteristics of a tube are far more important in determining its operating worth than are others. The cost of building a device to measure any one of the more important characteristics may be considerably higher than that of a device which measures a less representative characteristic. Consequently, three methods of test will be discussed, ranging from relatively simple and inexpensive equipment to more elaborate, more accurate, and more costly devices.

An **emission test** is perhaps the simplest method of indicating a tube's condition. (Refer to *Diodes*, in *Electrons, Electrodes, and Electron Tubes* section, for a discussion of electron emission.) Since emission falls off as the tube wears out, low emission is indicative of the end of tube serviceability. However, the emission test is subject to limitations because it tests the tube under static conditions and does not take into account the actual operation of the tube. On the one hand, coated filaments, or cathodes,

often develop active spots from which the emission is so great that the relatively small grid area adjacent to these spots cannot control the electron stream. Under these conditions, the total emission may indicate the tube to be normal although the tube is unsatisfactory. On the other hand, coated types of filaments are capable of such large emission that the tube will often operate satisfactorily after the emission has fallen far below the original value.

Fig. 107 shows the fundamental circuit diagram for an emission test. All of the electrodes of the tube, except the cathode, are connected to the plate. The filament, or heater, is operated at rated voltage; after the tube has reached con-

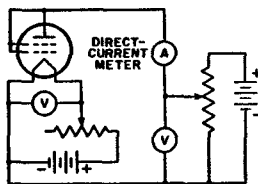

Fig. 107—Fundamental circuit of an emission tester

stant temperature, a low positive voltage is applied to the plate and the electron emission is read on the meter. Readings which are well below the average for a particular tube type indicate that the total number of available electrons has been so reduced that the tube is no longer able to function properly.

A **transconductance test** takes into account a fundamental operating principle of the tube. (This fact will be seen from the definition of transconductance in the Section on **Electron Tube Characteristics**.) It follows that transconductance tests, when properly made, permit better correlation between test results and actual performance than does a straight emission test.

There are two forms of transconductance test which can be utilized in a tube tester. In the first form (illustrated by Fig. 108 giving a fundamental circuit with a tetrode under test), appropriate operating voltages are applied to the electrodes of the tube. A plate current

depending upon the electrode voltages will then be indicated by the meter. If the bias on the grid is then shifted by the application of a different grid voltage, a new plate-current reading is obtained. The difference between the two plate-current readings is indicative of the transconductance of the tube. This

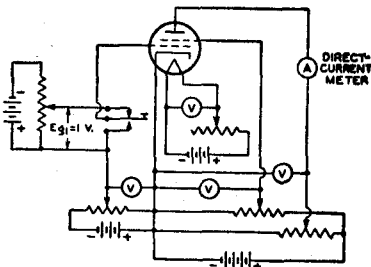

Fig. 108—Fundamental circuit of a transconductance tester using the "grid-shift" method.

method of transconductance testing is commonly called the "grid-shift" method, and depends on readings under static conditions. The fact that this form of test is made under static conditions imposes limitations not encountered in the second form of test made under dynamic conditions.

The dynamic transconductance test illustrated in Fig. 109 gives a fundamental circuit with a tetrode under test. This method is superior to the static transconductance test in that ac voltage

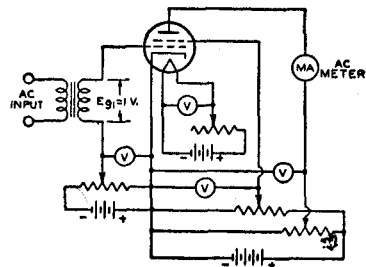

Fig. 109—Fundamental circuit of a dynamic transconductance tester.

is applied to the grid. Thus, the tube is tested under conditions which approximate actual operating conditions. The alternating component of the plate cur-

rent is read by means of an ac ammeter of the dynamometer type. The transconductance of the tube is equal to the ac plate current divided by the input-signal voltage. If a one-volt rms signal is applied to the grid, the plate-current-meter reading in milliamperes multiplied by one thousand is the value of transconductance in micromhos.

The power-output test probably gives the best correlation between test results and actual operating performance of a tube. In the case of voltage amplifiers, the power output is indicative of the amplification and output voltages obtainable from the tube. In the case of power-output tubes, the performance of the tube is closely checked. Consequently, although more complicated to set up, the power-output test will give closer correlation with actual performance than any other single test.

Fig. 110 shows the fundamental circuit of a power-output test for class A operation of tubes. The diagram illustrates the method for a pentode. The ac output voltage developed across the

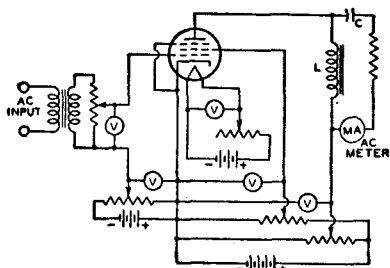

Fig. 110—Fundamental circuit of a power-output tester for class A operation of tubes.

plate-load impedance (L) is indicated by the current meter. The current meter is isolated as far as the dc plate current is concerned by the capacitor (C). The power output can be calculated from the current reading and known load resistance. In this way, it is possible to determine the operating condition of the tube quite accurately.

Fig. 111 shows the fundamental circuit of a power-output test for class B operation of tubes. With ac voltage



applied to the grid of the tube, the current in the plate circuit is read on a dc milliammeter. The power output of the tube is approximately equal to:

$$(I_b^2 \times R_L)/0.405,$$

where  $P_o$  is the power output in watts,  $I_b$  is the dc current in amperes, and  $R_L$  is the load resistance in ohms.

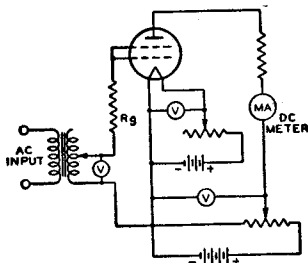

Fig. 111—Fundamental circuit of a power-output tester for class B operation of tubes.

### Essential Tube-Tester Requirements

1. The tester should provide for making a short-circuit test before measurement of the tube's characteristics.
2. It is important that some means of controlling the voltages applied to the electrodes of the tube be provided. If

the tester is ac operated, a line-voltage control permits the supply of proper electrode voltages.

3. It is essential that the rated voltage applied to the filament or heater be maintained accurately.

4. It is suggested that the characteristics test follow one of the methods described. The method selected and the quality of the parts used in the test will depend upon the user's requirements.

### Tube-Tester Limitations

A tube-testing device can only indicate the difference between a given tube's characteristics and those which are standard for that particular type. Since the operating conditions imposed upon a tube of a given type may vary within wide limits, it is impossible for a tube-testing device to evaluate tubes in terms of performance capabilities for all applications. The tube tester, therefore, cannot be looked upon as a final authority in determining whether or not a tube is always satisfactory. Actual operating test in the equipment in which the tube is to be used will give the best possible indication of a tube's worth.

# Resistance-Coupled Amplifiers

**R**ESISTANCE-COUPLED, audio-frequency voltage amplifiers utilize simple components and are capable of providing essentially uniform amplification over a relatively wide frequency range.

## Suitable Tubes

In this section, data are given for over 45 types of tubes suitable for use in resistance-coupled circuits. These types include low- and high- $\mu$  triodes, twin triodes, triode-connected pentodes, and pentodes. The accompanying key to tube types will assist in locating the appropriate data chart.

## Circuit Advantages

For most of the types shown, the data pertain to operation with cathode bias; for all of the pentodes, the data pertain to operation with series screen-grid resistor. The use of a cathode-bias resistor where feasible and a series screen-grid resistor where applicable offers several advantages over fixed-voltage operation.

The advantages are: (1) effects of possible tube differences are minimized; (2) operation over a wide range of plate-supply voltages without appreciable change in gain is feasible; (3) the low frequency at which the amplifier cuts off is easily changed; and (4) tendency toward motorboating is minimized.

## Number of Stages

These advantages can be enhanced by the addition of suitable decoupling filters in the plate supply of each stage of a multi-stage amplifier. With proper filters, three or more amplifier stages can be operated from a single power-supply unit of conventional design with-

Type	Chart No.	Type	Chart No.
3AU6	2	6CG7	8
3AV6	9	6CN7	5
3BC5	11	6EU7	9
3CB6	10	6FQ7	8
3CF6	11	6SL7GT	5
4AU6	2	6SN7GTB	8
4BQ7A	10	6T8A	5
4BZ7	10	7AU7	3
4CB6	11	8CG7	8
5BK7A	10	12AT6	5
5BQ7A	10	12AT7	4
5T8	5	12AU6	2
6AB4	4	12AU7A	3
6AG5	11	12AV6	9
6AT6	5	12AX7A	9
6AU6A	2	12AY7	1
6AV6	9	12SL7GT	5
6BC5	11	12SN7GTA	8
6BK7B	10	20EZ7	9
6BQ7A	10	5879P	6
6BZ7	10	5879T	7
6C4	3	7025	9
6CB6	11	7199P	12
6CB6A	11	7199T	13
6CF6	11		

T = Triode Unit or Triode Connection  
P = Pentode Unit or Pentode Connection

## KEY TO CHARTS

out encountering any difficulties due to coupling through the power unit. When decoupling filters are not used, not more than two stages should be operated from a single power-supply unit.

### Symbols Used in Resistance-Coupled Amplifier Charts

- C = Blocking Capacitor ( $\mu$ f).  
 $C_k$  = Cathode Bypass Capacitor ( $\mu$ f).  
 $C_{g2}$  = Screen-Grid Bypass Capacitor ( $\mu$ f).  
 $E_{bb}$  = Plate-Supply Voltage (volts).  
 Voltage at plate equals plate-supply voltage minus drop in  $R_p$  and  $R_k$ .  
 $R_k$  = Cathode Resistor (ohms).  
 $R_{g2}$  = Screen-Grid Resistor (megohms).  
 $R_g$  = Grid Resistor (megohms) for following stage.  
 $R_p$  = Plate Resistor (megohms).  
 V.G. = Voltage Gain.  
 $E_o$  = Output Voltage (peak volts).  
 This voltage is obtained across  $R_g$  (for following stage) at any frequency within the flat region of the output vs. frequency curve, and is for the condition where the signal level is adequate to swing the grid of the resistance-coupled amplifier tube to the point where its grid starts to draw current.

Note: The listed values for  $E_o$  are the peak output voltages available when the grid is driven from a low-impedance source. The listed values for the cathode resistors are optimum for any signal source. With a high-impedance source, protection against severe distortion and loss of gain due to input loading may be obtained by the use of a coupling capacitor connected directly to the input grid and a high-value resistor connected between the grid and ground.

### General Circuit Considerations

In the discussions which follow, the frequency ( $f_2$ ) is that value at which the high-frequency response begins to fall off. The frequency ( $f_1$ ) is that value at which the low-frequency response drops below a satisfactory value, as discussed below. A variation of 10 per cent in values of resistors and capacitors has only slight effect on perform-

ance. One-half-watt resistors are usually suitable for  $R_{g2}$ ,  $R_g$ ,  $R_p$ , and  $R_k$  resistors. Capacitors C and  $C_{g2}$  should have a working voltage equal to or greater than  $E_{bb}$ . Capacitor  $C_k$  may have a low working voltage in the order of 10 to 25 volts.

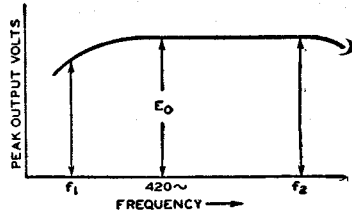

### Triode Amplifier Heater-Cathode Type

Capacitors C and  $C_k$  have been chosen to give an output voltage equal to 0.8  $E_o$  for a frequency ( $f_1$ ) of 100 cycles. For any other value of  $f_1$ , multiply values of C and  $C_k$  by  $100/f_1$ . In

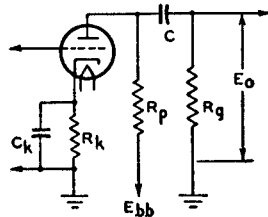

Diagram No. 1

the case of capacitor  $C_k$ , the values shown in the charts are for an amplifier with dc heater excitation; when ac is used, depending on the character of the associated circuit, the gain, and the value of  $f_1$ , it may be necessary to increase the value of  $C_k$  to minimize hum disturbances. It may be desirable to operate the heater at a positive voltage of from 15 to 40 volts with respect to the cathode. The voltage output at  $f_1$  of "n" like stages equals  $(0.8)^n \times E_o$ , where  $E_o$  is the peak output voltage of final stage. For an amplifier of typical construction, the value of  $f_2$  is well above the audio-frequency range for any value of  $R_p$ .

**Pentode Amplifier**  
*Heater-Cathode Type*

Capacitors  $C$ ,  $C_k$ , and  $C_{g2}$  have been chosen to give an output voltage equal to  $0.7 \times E_o$  for a frequency ( $f_1$ ) of 100 cycles. For any other value of  $f_1$ , multiply values of  $C$ ,  $C_k$ , and  $C_{g2}$  by  $100/f_1$ . In the case of capacitor  $C_k$ , the values shown in the charts are for

an amplifier with dc heater excitation; when ac is used, depending on the character of the associated circuits, the voltage gain, and the value of  $f_1$ , it may be necessary to increase the value of  $C_k$  to minimize hum disturbances. It may be desirable to operate the heater at a positive voltage of from 15 to 40 volts with respect to the cathode. The voltage output at  $f_1$  for "n" like stages equals  $(0.7)^n \times E_o$  where  $E_o$  is peak output voltage of final stage. For an amplifier of typical construction, and for  $R_p$  values of 0.1, 0.25, and 0.5 megohm, approximate values of  $f_2$  are 20000, 10000, and 5000 cycles per second, respectively.

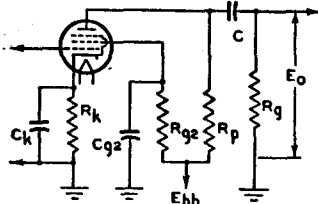

Diagram No. 2

1

**12AY7\***

See Circuit Diagram 1

$E_{bb}$	$R_p$	$R_g$	$R_{g2}$	$R_k$	$C_{g2}$	$C_k$	$C$	$E_o^*$	V.G.
90	0.1	0.24	—	1800	—	—	—	13	24
	0.24	0.51	—	3700	—	—	—	14	26
	0.51	1.0	—	7800	—	—	—	16	27
180	0.1	0.24	—	1300	—	—	—	31	27
	0.24	0.51	—	2800	—	—	—	33	29
	0.51	1.0	—	5700	—	—	—	33	30
300	0.1	0.24	—	1200	—	—	—	58	28
	0.24	0.51	—	2300	—	—	—	30	30
	0.51	1.0	—	4800	—	—	—	56	31

\* One triode unit.

\* Peak volts.

▲ Coupling capacitors should be selected to give desired frequency response. Cathode resistors should be adequately bypassed.

$E_{bb}$	$R_p$	$R_g$	$R_{g2}$	$R_k$	$C_{g2}$	$C_k$	$C$	$E_c^*$	V.G.
90	0.22	0.22	0.340	2700	0.057	5.8	0.0081	16	79
	0.22	0.47	0.370	2900	0.050	5.4	0.0055	22	104
	0.22	1.0	0.380	3100	0.050	5.3	0.0034	25	125
	0.47	0.47	1.00	6000	0.027	2.8	0.0042	13	105
	0.47	1.0	1.00	6200	0.023	2.7	0.0027	17	137
	0.47	2.2	1.00	6300	0.027	2.8	0.0019	25	161
	1.0	1.0	1.90	10800	0.017	1.7	0.0025	10	139
	1.0	2.2	2.40	13100	0.017	1.7	0.0017	19	184
180	0.22	0.22	0.520	1340	0.059	8.8	0.0081	31	143
	0.22	0.47	0.520	1390	0.059	8.7	0.0053	43	192
	0.22	1.0	0.520	1420	0.059	8.6	0.0032	48	223
	0.47	0.47	1.05	2700	0.039	5.5	0.0041	34	189
	0.47	1.0	1.15	2880	0.037	5.4	0.0027	43	249
	0.47	2.2	1.20	2960	0.036	5.4	0.0019	50	294
	1.0	1.0	2.40	5500	0.028	3.2	0.0023	33	230
	1.0	2.2	2.70	6000	0.022	2.8	0.0015	40	323
300	0.22	0.22	0.530	780	0.077	13.2	0.0082	53	200
	0.22	0.47	0.540	783	0.077	13.2	0.0053	65	270
	0.22	1.0	0.540	800	0.077	13.1	0.0033	74	316
	0.47	0.47	1.15	1590	0.057	8.4	0.0045	56	275
	0.47	1.0	1.22	1650	0.049	7.4	0.0027	72	357
	0.47	2.2	1.31	1720	0.045	7.2	0.0017	82	418
	1.0	1.0	2.50	3300	0.036	5.3	0.0022	57	352
	1.0	2.2	2.80	3500	0.031	4.2	0.0015	72	466

2

3AU6  
4AU6  
6AU6A  
12AU6See Circuit  
Diagram 2

90	0.047	0.047	—	1600	—	3.2	0.061	9	10
	0.047	0.1	—	1800	—	2.5	0.033	11	11
	0.047	0.22	—	2000	—	2.0	0.015	14	11
	0.1	0.1	—	3000	—	1.6	0.032	10	11
	0.1	0.22	—	3800	—	1.1	0.015	15	11
	0.1	0.47	—	4500	—	1.0	0.007	18	11
	0.22	0.22	—	6800	—	0.7	0.015	14	11
	0.22	0.47	—	9500	—	0.5	0.0065	20	11
	0.22	1.0	—	11500	—	0.43	0.0035	24	11
	180	0.047	0.047	—	920	—	3.9	0.062	20
0.047		0.1	—	1200	—	2.9	0.037	26	12
0.047		0.22	—	1400	—	2.5	0.016	29	12
0.1		0.1	—	2000	—	1.9	0.032	24	12
0.1		0.22	—	2800	—	1.4	0.016	33	12
0.1		0.47	—	3600	—	1.1	0.007	40	12
0.22		0.22	—	5300	—	0.8	0.015	31	12
0.22		0.47	—	8300	—	0.56	0.007	44	12
0.22		1.0	—	10000	—	0.48	0.0035	54	12
300		0.047	0.047	—	870	—	4.1	0.065	38
	0.047	0.1	—	1200	—	3.0	0.034	52	12
	0.047	0.22	—	1500	—	2.4	0.016	68	12
	0.1	0.1	—	1900	—	1.9	0.032	44	12
	0.1	0.22	—	3000	—	1.3	0.016	68	12
	0.1	0.47	—	4000	—	1.1	0.007	80	12
	0.22	0.22	—	5300	—	0.9	0.015	57	12
	0.22	0.47	—	8800	—	0.52	0.007	82	12
	0.22	1.0	—	11000	—	0.46	0.0035	92	12

3

6C4  
7AU7  
9AU7  
12AU7ASee Circuit  
Diagram 1

• One triode unit.

\* Peak volts.

4

6AB4  
12AT7\*See Circuit  
Diagram 1

$E_{bb}$	$R_p$	$R_g$	$R_{g2}$	$R_k$	$C_{g2}$	$C_k$	$C$	$E_o^*$	V.G.
90	0.1	0.1	—	2680	—	2.4	0.026	8	24
	0.1	0.22	—	3060	—	2.00	0.014	11	25
	0.1	0.47	—	3390	—	1.84	0.0074	13	28
	0.22	0.22	—	5500	—	1.33	0.0136	10	25
	0.22	0.47	—	6300	—	1.01	0.0067	14	28
	0.22	1.0	—	6930	—	0.92	0.0038	15	28
	0.47	0.47	—	10900	—	0.63	0.007	13	26
	0.47	1.0	—	12500	—	0.52	0.0043	14	28
	0.47	2.2	—	13500	—	0.47	0.0031	18	28
180	0.1	0.1	—	1407	—	3.6	0.029	20	31
	0.1	0.22	—	1674	—	3.0	0.016	28	33
	0.1	0.47	—	1786	—	2.6	0.0083	31	34
	0.22	0.22	—	2890	—	1.75	0.0140	24	33
	0.22	0.47	—	3860	—	1.34	0.0077	35	33
	0.22	1.0	—	4660	—	1.14	0.0047	42	33
	0.47	0.47	—	6960	—	0.83	0.0075	31	31
	0.47	1.0	—	8450	—	0.67	0.0046	39	32
	0.47	2.2	—	9600	—	0.55	0.0032	45	32
300	0.1	0.1	—	974	—	4.0	0.028	37	34
	0.1	0.22	—	1404	—	3.1	0.015	57	34
	0.1	0.47	—	2169	—	2.5	0.0083	78	33
	0.22	0.22	—	2510	—	1.9	0.015	50	33
	0.22	0.47	—	4200	—	1.3	0.0074	78	33
	0.22	1.0	—	4950	—	1.1	0.0046	85	32
	0.47	0.47	—	5700	—	0.90	0.0076	57	33
	0.47	1.0	—	8720	—	0.62	0.0041	81	32
	0.47	2.2	—	9700	—	0.57	0.0030	88	32

5

5T8  
6AT6  
6CN7  
8CN7  
6SL7GT\*  
6T8A  
12AT6  
12SL7GT\*  
19T8See Circuit  
Diagram 1

90	0.1	0.1	—	4200	—	2.5	0.025	5.4	22
	0.1	0.22	—	4600	—	2.2	0.014	7.5	27
	0.1	0.47	—	4800	—	2.0	0.0065	9.1	30
	0.22	0.22	—	7000	—	1.5	0.013	7.3	30
	0.22	0.47	—	7800	—	1.3	0.007	10	34
	0.22	1.0	—	8100	—	1.1	0.0035	12	37
	0.47	0.47	—	12000	—	0.83	0.006	10	36
	0.47	1.0	—	14000	—	0.7	0.0035	14	39
	0.47	2.2	—	15000	—	0.6	0.002	16	41
180	0.1	0.1	—	1900	—	3.6	0.027	19	30
	0.1	0.22	—	2200	—	3.1	0.014	25	35
	0.1	0.47	—	2500	—	2.8	0.0065	32	37
	0.22	0.22	—	3400	—	2.2	0.014	24	38
	0.22	0.47	—	4100	—	1.7	0.0065	34	42
	0.22	1.0	—	4600	—	1.5	0.0035	38	44
	0.47	0.47	—	6600	—	1.1	0.0065	29	44
	0.47	1.0	—	8100	—	0.9	0.0035	38	46
	0.47	2.2	—	9100	—	0.8	0.002	43	47
300	0.1	0.1	—	1500	—	4.4	0.027	40	34
	0.1	0.22	—	1800	—	3.6	0.014	54	38
	0.1	0.47	—	2100	—	3.0	0.0065	63	41
	0.22	0.22	—	2600	—	2.5	0.013	51	42
	0.22	0.47	—	3200	—	1.9	0.0065	65	46
	0.22	1.0	—	3700	—	1.6	0.0035	77	48
	0.47	0.47	—	5200	—	1.2	0.006	61	48
	0.47	1.0	—	6300	—	1.0	0.0035	74	50
	0.47	2.2	—	7200	—	0.9	0.002	85	51

\* One triode unit.

\* Peak volts.

$E_{bb}$	$R_p$	$R_g$	$R_{g2}$	$R_k$	$C_{g2}$	$C_k$	$C$	$E_o^*$	V.G.
90	0.1	0.1	0.35	1700	0.044	4.6	0.020	13	29
	0.1	0.22	0.35	1700	0.046	4.5	0.012	17	39
	0.1	0.47	0.35	1700	0.047	4.4	0.006	20	47
	0.22	0.22	0.80	3000	0.034	3.2	0.010	15	43
	0.22	0.47	0.80	3000	0.035	3.1	0.005	21	59
	0.22	1.0	0.80	3000	0.036	3.0	0.003	24	67
	0.47	0.47	1.9	7000	0.021	1.8	0.005	21	59
	0.47	1.0	1.9	7000	0.022	1.7	0.003	25	75
	0.47	2.2	1.9	7000	0.023	1.7	0.002	28	87
180	0.1	0.1	0.35	700	0.060	7.4	0.020	24	39
	0.1	0.22	0.35	700	0.062	7.3	0.012	28	56
	0.1	0.47	0.35	700	0.064	7.2	0.006	33	65
	0.22	0.22	0.80	1200	0.045	5.5	0.010	24	65
	0.22	0.47	0.80	1200	0.046	5.3	0.005	31	87
	0.22	1.0	0.80	1200	0.048	5.2	0.003	34	101
	0.47	0.47	1.9	2500	0.033	3.5	0.005	27	98
	0.47	1.0	1.9	2500	0.034	3.4	0.003	32	122
	0.47	2.2	1.9	2500	0.035	3.3	0.002	37	140
300	0.1	0.1	0.35	300	0.075	10.8	0.020	25	51
	0.1	0.22	0.35	300	0.077	10.6	0.012	32	68
	0.1	0.47	0.35	300	0.080	10.5	0.006	35	83
	0.22	0.22	0.80	600	0.056	7.9	0.010	28	81
	0.22	0.47	0.80	600	0.057	7.5	0.005	37	109
	0.22	1.0	0.80	600	0.058	7.4	0.003	41	123
	0.47	0.47	1.3	1200	0.044	5.3	0.005	34	125
	0.47	1.0	1.3	1200	0.046	5.2	0.003	42	152
	0.47	2.2	1.3	1200	0.047	5.1	0.002	48	174
90	0.047	0.047	—	1800	—	2.9	0.060	9	10
	0.047	0.1	—	2100	—	2.4	0.033	12	11
	0.047	0.22	—	2200	—	2.3	0.016	14	21
	0.1	0.1	—	3200	—	1.8	0.027	10	12
	0.1	0.22	—	3900	—	1.3	0.015	13	13
	0.1	0.47	—	4300	—	1.0	0.007	16	13
	0.22	0.22	—	6200	—	0.87	0.015	12	13
	0.22	0.47	—	8100	—	0.53	0.006	16	13
	0.22	1.00	—	9000	—	0.49	0.003	19	14
180	0.047	0.047	—	1200	—	3.5	0.063	21	12
	0.047	0.1	—	1600	—	2.6	0.033	29	13
	0.047	0.22	—	1800	—	2.4	0.016	35	13
	0.1	0.1	—	2200	—	1.9	0.031	26	13
	0.1	0.22	—	2900	—	1.35	0.015	33	14
	0.1	0.47	—	3400	—	1.1	0.007	40	14
	0.22	0.22	—	4500	—	0.92	0.015	28	14
	0.22	0.47	—	6400	—	0.61	0.006	39	14
	0.22	1.00	—	8200	—	0.52	0.003	47	14
300	0.047	0.047	—	1100	—	3.9	0.063	42	13
	0.047	0.1	—	1500	—	2.8	0.033	65	13
	0.047	0.22	—	1700	—	2.5	0.016	71	14
	0.1	0.1	—	2000	—	2.1	0.032	45	15
	0.1	0.22	—	3400	—	1.4	0.015	74	15
	0.1	0.47	—	3700	—	1.1	0.007	83	15
	0.1	0.22	—	4300	—	0.97	0.015	50	15
	0.22	0.47	—	7200	—	0.63	0.007	88	15
	0.22	1.00	—	7400	—	0.63	0.003	94	15

\* Peak volts.

6

As Pentode:  
5879See Circuit  
Diagram 2

7

As Triode:

5879

See Circuit  
Diagram 1

8

6CG7\*  
6FQ7  
6SN7GTB\*  
8CG7  
8FQ7\*  
12SN7GTA\*

See Circuit  
Diagram 1

$E_{bb}$	$R_p$	$R_g$	$R_{g2}$	$R_k$	$C_{g2}$	$C_k$	$C$	$E_o^*$	V.G.
90	0.047	0.047	—	1870	—	3.1	0.063	14	13
	0.047	0.1	—	2230	—	2.5	0.031	18	14
	0.047	0.22	—	2500	—	2.1	0.016	20	14
	0.1	0.1	—	3370	—	1.8	0.034	15	14
	0.1	0.22	—	4100	—	1.3	0.015	20	14
	0.1	0.47	—	4800	—	1.1	0.006	23	15
	0.22	0.22	—	7000	—	0.80	0.013	16	14
	0.22	0.47	—	9100	—	0.65	0.007	22	14
	0.22	1.00	—	10500	—	0.60	0.004	25	15
180	0.047	0.047	—	1500	—	3.6	0.066	33	14
	0.047	0.1	—	1860	—	2.9	0.055	41	14
	0.047	0.22	—	2160	—	2.2	0.015	47	15
	0.1	0.1	—	2750	—	1.8	0.028	35	15
	0.1	0.22	—	3550	—	1.4	0.015	45	15
	0.1	0.47	—	4140	—	1.3	0.007	51	16
	0.22	0.22	—	5150	—	1.0	0.016	36	16
	0.22	0.47	—	7000	—	0.71	0.007	45	16
	0.22	1.00	—	7800	—	0.61	0.004	51	16
300	0.047	0.047	—	1300	—	3.6	0.061	59	14
	0.047	0.1	—	1580	—	3.0	0.032	73	15
	0.047	0.22	—	1800	—	2.5	0.015	83	16
	0.1	0.1	—	2500	—	1.9	0.031	68	16
	0.1	0.22	—	3130	—	1.4	0.014	82	16
	0.1	0.47	—	3900	—	1.2	0.0065	96	16
	0.22	0.22	—	4800	—	0.95	0.015	68	16
	0.22	0.47	—	6500	—	0.69	0.0065	85	16
	0.22	1.00	—	7800	—	0.58	0.0035	96	16
90	0.1	0.1	—	4400	—	2.7	0.023	5	29
	0.1	0.22	—	4700	—	2.4	0.013	6	35
	0.1	0.47	—	4800	—	2.3	0.007	8	41
	0.22	0.22	—	7000	—	1.6	0.012	6	39
	0.22	0.47	—	7400	—	1.4	0.006	9	45
	0.22	1.0	—	7600	—	1.3	0.003	11	48
	0.47	0.47	—	12000	—	0.9	0.006	9	48
	0.47	1.0	—	13000	—	0.8	0.003	11	52
	0.47	2.2	—	14000	—	0.7	0.002	13	55
180	0.1	0.1	—	1800	—	4.0	0.025	18	40
	0.1	0.22	—	2000	—	3.5	0.013	25	47
	0.1	0.47	—	2200	—	3.1	0.006	32	52
	0.22	0.22	—	3000	—	2.4	0.012	24	53
	0.22	0.47	—	3500	—	2.1	0.006	34	59
	0.22	1.0	—	3900	—	1.8	0.003	39	63
	0.47	0.47	—	5800	—	1.3	0.006	30	62
	0.47	1.0	—	6700	—	1.1	0.003	39	66
	0.47	2.2	—	7400	—	1.0	0.002	45	68
300	0.1	0.1	—	1300	—	4.6	0.027	43	45
	0.1	0.22	—	1500	—	4.0	0.013	57	52
	0.1	0.47	—	1700	—	3.6	0.006	66	57
	0.22	0.22	—	2200	—	3.0	0.013	54	59
	0.22	0.47	—	2800	—	2.3	0.006	69	65
	0.22	1.0	—	3100	—	2.1	0.003	79	68
	0.47	0.47	—	4300	—	1.6	0.006	62	69
	0.47	1.0	—	5200	—	1.3	0.003	77	73
	0.47	2.2	—	5900	—	1.1	0.002	92	75

3AV6  
4AV6  
6AV6  
6EU7\*  
12AV6  
12AX7A\*  
20EZ7\*  
7025\*

See Circuit  
Diagram 1

\* One triode unit. \* Peak volts.



$E_{bb}$	$R_p$	$R_g$	$R_{g2}$	$R_k$	$G_{g2}$	$G_k$	$C$	$E_o^*$	V.G.
90	0.047	0.047	—	1580	—	4.0	0.058	9	18
	0.047	0.10	—	1760	—	3.5	0.032	13	19
	0.047	0.22	—	1820	—	3.0	0.015	16	20
	0.1	0.1	—	2920	—	2.1	0.029	12	19
	0.1	0.22	—	3570	—	1.7	0.015	17	20
	0.1	0.47	—	4020	—	1.4	0.0075	20	20
	0.22	0.22	—	6040	—	0.98	0.0135	16	19
	0.22	0.47	—	7500	—	0.78	0.0075	21	20
	0.22	1.0	—	8800	—	0.63	0.0036	25	20
180	0.047	0.047	—	694	—	6.0	0.062	25	23
	0.047	0.1	—	817	—	4.4	0.032	32	24
	0.047	0.22	—	905	—	4.0	0.0155	35	25
	0.10	0.1	—	1596	—	2.80	0.030	30	23
	0.10	0.22	—	1630	—	2.30	0.0152	32	24
	0.10	0.47	—	1860	—	2.00	0.0073	38	24
	0.22	0.22	—	3950	—	1.24	0.0150	35	22
	0.22	0.47	—	4500	—	0.96	0.0072	41	23
	0.22	1.0	—	5530	—	0.79	0.0038	49	23
300	0.047	0.047	—	438	—	6.70	0.062	38	26
	0.047	0.1	—	542	—	5.50	0.032	48	27
	0.047	0.22	—	644	—	4.30	0.016	57	27
	0.10	0.10	—	1009	—	3.5	0.031	42	25
	0.10	0.22	—	1332	—	2.5	0.015	56	26
	0.10	0.47	—	1609	—	2.1	0.0074	64	25
	0.22	0.22	—	2623	—	1.5	0.015	50	24
	0.22	0.47	—	3900	—	1.1	0.0073	70	24
0.22	1.0	—	4920	—	0.88	0.0039	84	24	
90	0.22	0.22	0.480	3800	0.046	5.5	0.0084	10	89
	0.22	0.47	0.480	3800	0.049	5.5	0.0054	16	114
	0.22	1.0	0.500	4400	0.045	5.3	0.0034	23	128
	0.47	0.47	1.04	7200	0.033	2.9	0.0044	10	111
	0.47	1.0	1.04	7700	0.033	2.8	0.0029	15	133
	0.47	2.2	1.10	8400	0.031	2.6	0.0020	18	152
	1.0	1.0	2.50	16000	0.018	1.4	0.0023	10	118
	1.0	2.2	2.50	18600	0.016	1.2	0.0017	11	139
180	0.22	0.22	0.550	1600	0.072	9.5	0.0090	30	161
	0.22	0.47	0.620	1800	0.062	8.5	0.0053	36	208
	0.22	1.0	0.650	1900	0.062	8.5	0.0034	43	239
	0.47	0.47	1.00	3400	0.059	6.0	0.0048	34	183
	0.47	1.0	1.00	3500	0.059	6.0	0.0031	41	229
	0.47	2.2	1.00	3800	0.059	5.8	0.0020	46	262
	1.0	1.0	2.60	7300	0.029	2.7	0.0022	33	227
	1.0	2.2	2.60	7400	0.029	2.7	0.0016	38	281
300	0.22	0.22	0.600	980	0.085	13.0	0.0085	51	223
	0.22	0.47	0.680	1090	0.084	12.0	0.0055	64	288
	0.22	1.0	0.700	1150	0.081	11.0	0.0033	74	334
	0.47	0.47	1.25	2000	0.064	7.9	0.0045	52	285
	0.47	1.0	1.34	2150	0.061	7.6	0.0029	67	363
	0.47	2.2	1.53	2350	0.057	7.1	0.0019	79	416
	1.0	1.0	2.60	4000	0.044	5.2	0.0023	51	334
1.0	2.2	3.00	4700	0.038	4.3	0.0015	69	427	

10

4BQ7A\*  
4BZ7\*  
5BK7A\*  
5BQ7A\*  
6BK7B\*  
6BQ7A\*  
6BZ7\*

See Circuit Diagram 1

11

3BC5  
3CB6  
3CF6  
4CB6  
6AG5  
6BC5  
6CB6  
6CB6A  
6CF6

See Circuit Diagram 2

\* One triode unit.

\* Peak volts.

**12**

**7199**

Pentode  
Unit

See Circuit  
Diagram 2

$E_{bb}$	$R_p$	$R_g$	$R_{g2}$	$R_k$	$C_{g2}$	$C_k$	$C$	$E_o^*$	V.G.
90	0.22	0.22	0.560	3700	0.046	4.50	0.0090	12	73
	0.22	0.47	0.600	3900	0.043	4.30	0.0055	17	95
	0.22	1.0	0.640	4200	0.039	4.00	0.0033	19	109
	0.47	0.47	0.870	6000	0.036	2.70	0.0046	16	95
	0.47	1.0	0.980	6700	0.044	3.00	0.0030	22	113
	0.47	2.2	1.00	6700	0.043	2.80	0.0020	25	131
	1.0	1.0	2.00	12200	0.021	1.44	0.0028	15	119
	1.0	2.2	2.20	12800	0.024	1.74	0.0016	21	167
	180	0.22	0.22	0.530	1570	0.069	7.50	0.0088	32
0.22		0.47	0.600	1730	0.064	7.40	0.0064	38	164
0.22		1.0	0.650	1820	0.061	7.30	0.0034	45	190
0.47		0.47	1.12	3200	0.053	5.30	0.0046	35	147
0.47		1.0	1.40	3500	0.042	5.10	0.0028	40	209
0.47		2.2	1.57	3740	0.040	5.40	0.0019	45	250
1.0		1.0	2.50	6500	0.039	2.80	0.0024	34	179
1.0		2.2	3.40	7500	0.026	2.30	0.0015	39	277
300	0.22	0.22	0.600	9200	0.086	11.2	0.0085	52	182
	0.22	0.47	0.670	1010	0.076	10.5	0.0052	66	236
	0.22	1.0	0.720	1100	0.076	10.0	0.0033	77	257
	0.47	0.47	1.25	1950	0.060	7.0	0.0044	41	221
	0.47	1.0	1.43	3210	0.053	6.4	0.0027	72	296
	0.47	2.2	1.45	2200	0.055	6.3	0.0019	82	345
	1.0	1.0	3.00	4100	0.040	4.2	0.0022	57	295
	1.0	2.2	3.30	4340	0.037	3.6	0.0016	74	378
90	0.047	0.047	—	1292	—	3.3	0.060	8	12
	0.047	0.1	—	1401	—	2.8	0.032	10	13
	0.047	0.22	—	1470	—	2.4	0.016	11	13
	0.10	0.1	—	2630	—	1.60	0.029	9	13
	0.10	0.22	—	3090	—	1.24	0.015	12	13
	0.10	0.47	—	3440	—	1.10	0.008	14	14
	0.22	0.22	—	6550	—	0.70	0.015	12	12
	0.22	0.47	—	8270	—	0.51	0.0077	16	12
	0.22	1.0	—	9130	—	0.44	0.0045	18	12
	180	0.047	0.047	—	723	—	4.0	0.061	16
0.047		0.1	—	836	—	3.5	0.032	20	14
0.047		0.22	—	948	—	2.9	0.016	24	15
0.10		0.1	—	1543	—	2.0	0.031	17	14
0.10		0.22	—	2002	—	1.6	0.016	24	14
0.10		0.47	—	2522	—	1.2	0.0082	30	13
0.22		0.22	—	4390	—	0.79	0.015	24	13
0.22		0.47	—	6122	—	0.57	0.0078	33	12
0.22		1.0	—	8060	—	0.47	0.0046	41	12
300	0.047	0.047	—	534	—	4.0	0.061	27	15
	0.047	0.1	—	726	—	3.6	0.031	38	15
	0.047	0.22	—	840	—	3.0	0.015	44	15
	0.10	0.1	—	1117	—	2.3	0.031	26	15
	0.10	0.22	—	1613	—	1.7	0.0155	41	14
	0.10	0.47	—	2043	—	1.31	0.0078	51	14
	0.22	0.22	—	3133	—	0.93	0.015	36	13
	0.22	0.47	—	4480	—	0.69	0.0079	51	13
	0.22	1.0	—	4930	—	0.56	0.0045	55	13

**7199**

Triode  
Unit

See Circuit  
Diagram 1

\* Peak volts.

# Outlines

## METAL TYPES

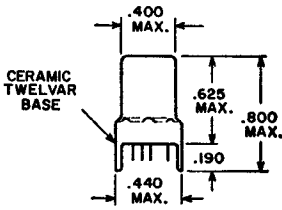

-1-

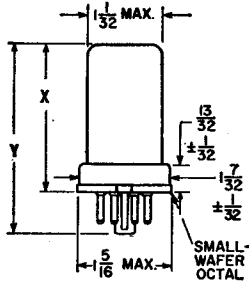

-2-

	Y	X
2A	2-5/8	2-1/16
2B	3-1/4	2-11/16

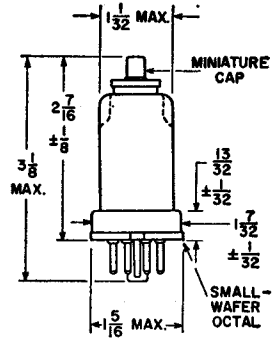

-3-

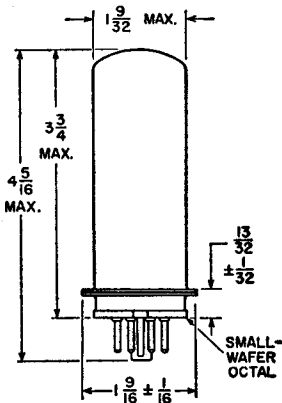

-4-

## GLASS TYPES

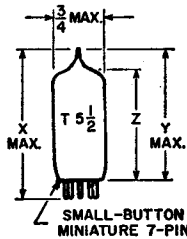

-5-

	X	Y	Z
5A	1-5/8	1-3/8	1 ± 3/32
5B	1-3/4	1-1/2	1-1/8 ± 3/32
5C	2-1/8	1-7/8	1-1/2 ± 3/32
5D	2-5/8	2-3/8	2 ± 3/32

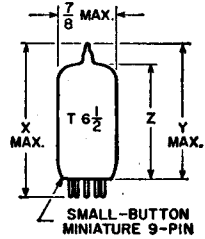

-6-

	X	Y
6A	1-3/4	1-1/2
6B	2-3/16	1-15/16
6C	2-13/32	2-5/32
6D	2-7/16	2-13/16
6E	2-5/8	2-3/8
6F	2-3/4	2-1/2
6G	3-1/16	2-13/16
6H	3-1/8	2-7/8
6J	2	1-3/4
6K	2-7/16	2-3/16

	Z
6A	1-1/8 ± 3/32
6B	1-9/16 ± 3/32
6C	1-25/32 ± 3/32
6D	1-13/16 ± 3/32
6E	2 ± 3/32
6F	2-1/8 ± 3/32
6G	2-7/16 ± 3/32
6H	2-1/2 ± 3/32
6J	—
6K	1-29/32

All measurements in inches.

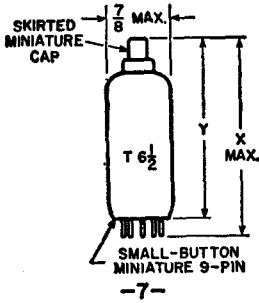

-7-

	X	Y
7A	2.27/32	2-7/16 ± 1/8
7B	3-1/16	2-15/32 MAX.
7C	3-9/32	2-7/8 ± 1/8
7D	3-1/2	3-1/4 MAX.

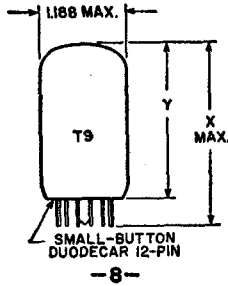

-8-

	X	Y
8A	1.875	1.250-1.500
8B	2.375	1.750-2.000
8C	2.625	2.000-2.250
8D	2.875	2.250-2.500
8E	3.050	2.770 MAX.

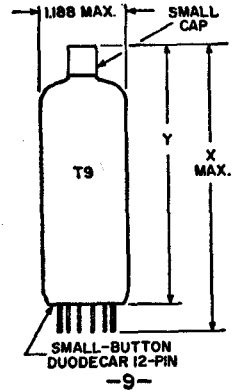

-9-

	X	Y
9A	3.375	2.750-3.000
9B	3.625	3.000-3.250
9C	4.110	3.766 MAX.

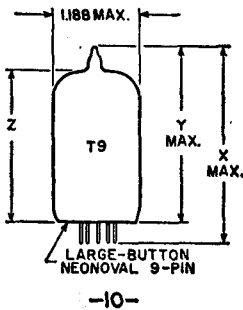

-10-

	X	Y	Z
10A	2.630	2.320	1.770-2.010
10B	2.900	2.620	2.070-2.310
10C	2.930	2.620	2.070-2.310
10D	3.230	2.920	2.370-2.610
10E	4.125	3.750	
10F	3.110	2.730	
10G	3.080	2.770	

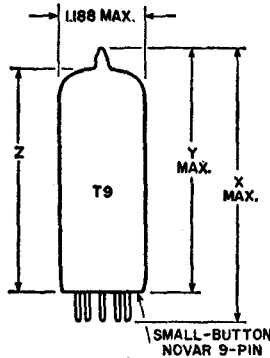

-11-

	X	Y	Z
11A	3.000	2.620	2.100-2.280
11B	3.080	2.700	2.050-2.230
11C	3.110	2.730	2.210-2.390
11D	3.410	3.010	2.510-2.690
11E	2.960	2.580	2.060-2.240

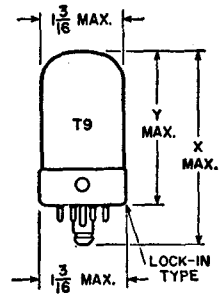

-12-

	X	Y
12A	2-9/32	1-3/4
12B	2-25/32	2-1/4
12C	3-5/32	2-5/8

All measurements in inches.

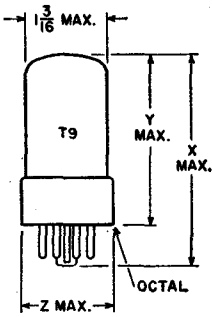

-13-

	X	Y	Z
13A	2-7/8	2-5/16	1-9/32
13B	3	2-7/16	1-9/32
13C	3-1/16	2-1/2	1-9/32
13D	3-5/16	2-3/4	1-5/16
13E	3-3/8	2-13/16	1-9/32
13F	3-7/16	2-7/8	1-9/32
13G	3-13/16	3-1/4	1-9/32
13H	4-3/16	3-9/16	1-3/16

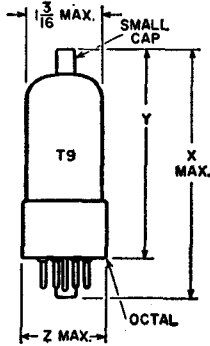

-14-

	X	Y	Z
14A	3-5/16	2-3/4	1-5/16
14B	3-9/16	3	1-9/32
14C	3-5/8	3-1/16	1-9/32
14D	3-7/8	3-5/16	1-9/32
14E	4-1/16	3-1/2	1-9/32

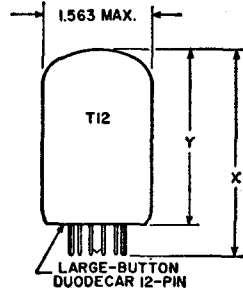

-15-

	X	Y
15A	2.875	2.250-2.500
15B	3.375	3.000 MAX.
15C	3.625	3.000-3.250
15D	3.125	2.750

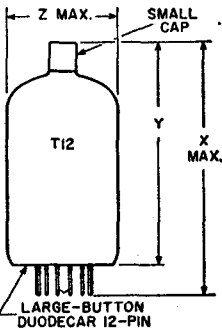

-16-

	X	Y	Z
16A	3.625	3.000-3.250	1.563
16B	4.125	3.500-3.750	1.563

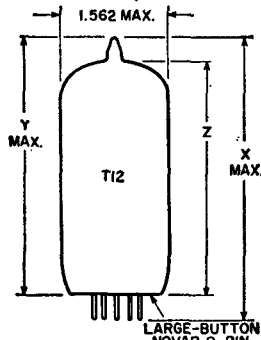

-17-

	X	Y	Z
17A	3.180	2.800	2.280-2.460
17B	3.410	3.030	2.510-2.690
17C	4.160	3.780	3.260-3.440
17D	3.550	3.170	

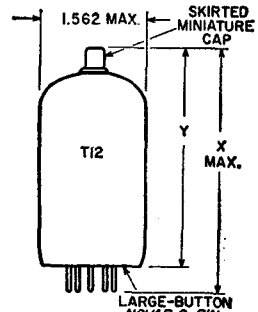

-18-

	X	Y
18A	3.55	3.04 ± 0.13
18B	4.60	4.09 ± 0.13

All measurements in inches.

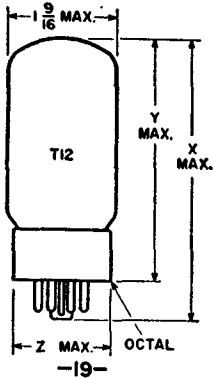

-19-

	X	Y	Z
19A	3-9/16	3	1-9/32
19B	3-7/8	3.5/16	1-13/32
19C	4	3-7/16	1-13/32
19D	4-1/4	3-11/16	1-3/8
19E	4-5/8	4-1/16	1-3/8
19F	4-5/8	4-1/16	1-5/8
19G	4-3/4	4-3/16	1-11/16
19H	5-3/16	4-5/8	1-3/8

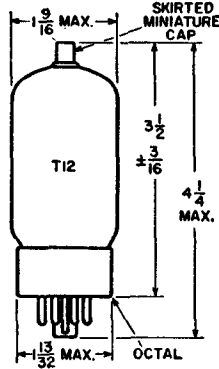

-20-

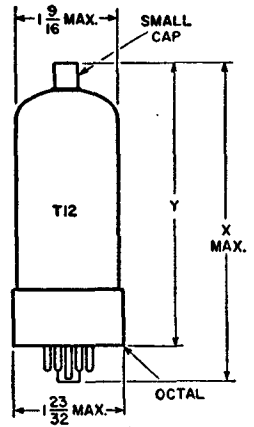

-21-

	X	Y
21A	4-3/4	4 ± 3/16
21B	5	4-7/16
21C	5-7/32	4-1/4

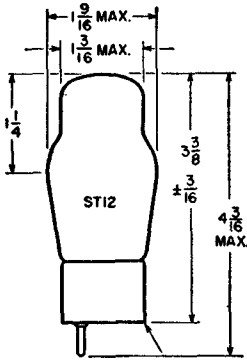

OCTAL OR SMALL-SHELL  
SMALL 4-, 5-, 6-, OR 7-PIN  
-22-

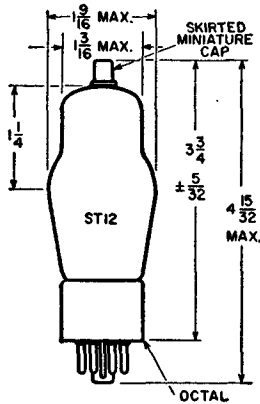

-23-

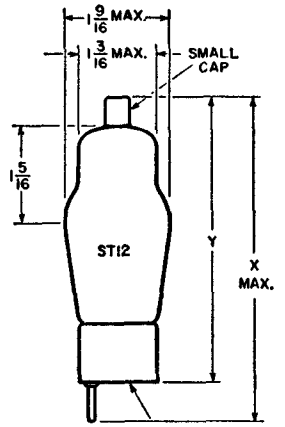

SMALL-SHELL  
SMALL 4-, 5-, 6-, OR 7-PIN  
-24-

	X	Y
24A	4-15/16	4-3/16 ± 1/8
24B	4-17/32	3.25/32 ± 1/8

All measurements in inches.

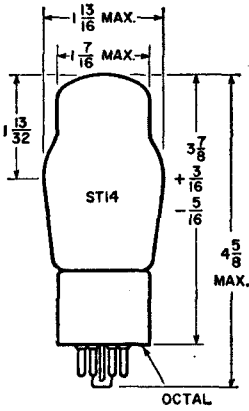

-25-

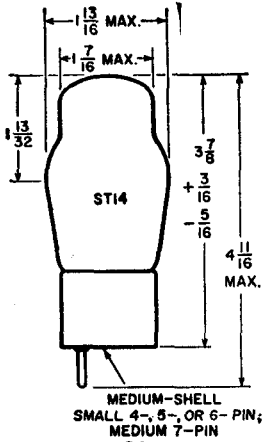

-26-

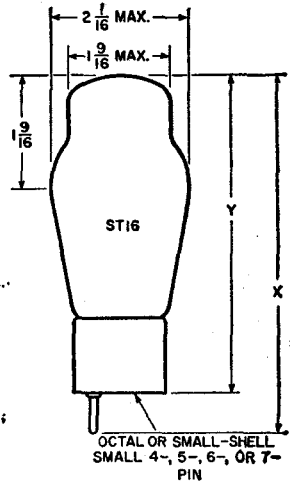

-27-

	X	Y
27A	5-1/8	4-3/8 ± 3/16
27B	5-3/8	4-9/16 ± 3/16

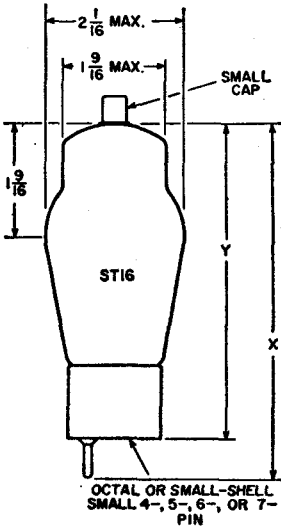

-28-

	X	Y
28A	5-1/8	4-7/16 ± 5/32
28B	5-11/16	4-31/32 ± 5/32

	MAX. LENGTH	MAX. DIAMETER
29A	1-3/4	0.4
29B	1-3/4	1-5/16
29C	2-5/16	1-5/16
29D	2-5/8	1-1/16
29E	2-7/8	1-5/16
29F	3	1-5/16
29G	3-7/16	1-15/16
29H	4	1-3/16
29I	4-7/8	1-9/16
29J	5-1/32	1-13/16
29K	6-1/4	2-7/16
29M	3-15/32	1-7/16

-29-

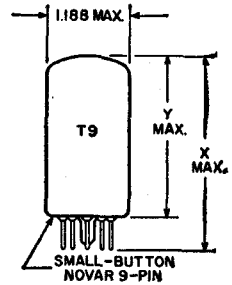

-30-

	X	Y
30A	2.330	2.000
30B	3.005	2.625
30C	3.080	2.700
30D	3.110	2.730
30E	2.125	1.750

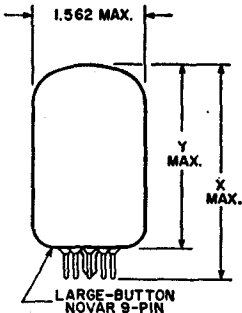

-31-

	X	Y
31A	2.880	2.500
31B	3.130	2.750
31C	3.880	3.500

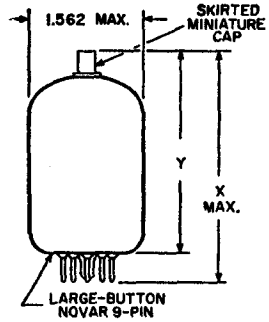

-32-

	X	Y
32	3.505	2.875-3.125
32A	4.130	3.500-3.750

All measurements in inches.



# Circuits

**T**HE circuits included in this Manual illustrate some of the more important applications of RCA receiving tubes; they are not necessarily examples of commercial practice. These circuits have been conservatively designed and are capable of excellent performance. Electrical specifications are given for circuit components to assist those interested in home construction. Layouts and mechanical details are omitted because they vary widely with the requirements of individual set builders and with the sizes and shapes of the components employed.

Circuits designed for operation from both ac and dc voltage supplies should be installed in non-metallic cabinets or properly insulated from metallic cabinets. Potentiometer shafts and switches should make use of insulated (plastic) knobs. In practical use, no metallic part of an "ac/dc" chassis should be exposed to touch, accidental or otherwise. When such circuits are tested outside of their cabinets, a line isolation transformer such as the RCA WP-25A Isotap should be used.

Performance of these circuits depends as much on the quality of the components selected and the care employed in layout and construction as on the circuits themselves. Good signal reproduction from receivers and amplifiers requires the use of good-quality speakers, transformers, chokes, and input sources (microphones, phonograph pickups, etc).

Coils for the receiver circuits may be purchased at local parts dealers by

specifying the characteristics required: for rf coils, the circuit position (antenna or interstage), tuning range desired, and tuning capacitances employed; for if coils or transformers, the intermediate frequency, circuit position (1st if, 2nd if, etc.), and, in some cases, the associated tube types; for oscillator coils, the receiver tuning range, the intermediate frequency, the type of converter tube, and the type of winding used (tapped or transformer-coupled).

The voltage ratings specified for capacitors are the minimum dc working voltages required. Paper, mica, or ceramic capacitors having higher voltage ratings than those specified may be used except insofar as the physical sizes of such capacitors may affect equipment layout. However, if electrolytic capacitors having substantially higher voltage ratings than those specified are used, they may not "form" completely at the operating voltage, with the result that the effective capacitances of such units may be below their rated value. The wattage ratings specified for resistors assume methods of construction that provide adequate ventilation; compact installations having poor ventilation may require resistors of higher wattage ratings.

Circuits which work at very high frequencies or which are required to handle very wide bandwidths demand more than ordinary skill and experience in construction. Placement of component parts is quite critical and may require considerable experimentation. All rf leads to components including bypass

capacitors must be kept short and must be properly dressed to minimize undesirable coupling and capacitance effects. Correct circuit alignment and oscillator tracking may require the use of a cathode-ray oscilloscope, a high-impedance vacuum-tube voltmeter, and a signal

generator capable of supplying a properly modulated signal at the appropriate frequencies. Unless the builder has had considerable experience with broadband, high-frequency circuits, he should not undertake the construction of such circuits.

### LIST OF CIRCUITS

	Page
<b>24-1</b> Portable Battery-Operated Superheterodyne Receiver .....	521
<b>24-2</b> AC/DC Superheterodyne Receiver .....	522
<b>24-3</b> Code-Practice Oscillator .....	523
<b>24-4</b> AM/FM Receiver .....	524
<b>24-5</b> Citizens-Band Transceiver (26.965 to 27.255 Mc/s) .....	526
<b>24-6</b> Preamplifier for Amateur Receiver 30- and 50-Mc/s Amateur Bands and 27-Mc/s Citizens Band .....	528
<b>24-7</b> FM Stereo Multiplex Adapter .....	529
<b>24-8</b> FM Tuner .....	530
<b>24-9</b> Three-Stage IF Amplifier/Limiter and Detector .....	532
<b>24-10</b> Intercommunication Set (With Master Unit and Two or More Remote Units) .....	533
<b>24-11</b> High-Fidelity Audio Amplifier (Class AB <sub>1</sub> ; Power Output, 15 Watts) .....	534
<b>24-12</b> High-Fidelity Audio Amplifier (Class AB <sub>1</sub> ; Power Output, 30 Watts) .....	535
<b>24-13</b> High-Fidelity Audio Amplifier (Class AB <sub>1</sub> ; Power Output, 50 Watts) .....	536
<b>24-14</b> Two-Channel Audio Mixer .....	538
<b>24-15</b> Two-Channel Stereophonic Amplifier (Power Output, 1 Watt Each Channel) .....	539
<b>24-16</b> Microphone and Phonograph Amplifier (Power Output, 8 Watts) ...	540
<b>24-17</b> Phonograph Amplifier (Power Output, 1 Watt) .....	541
<b>24-18</b> Preamplifier for Magnetic Phonograph Pickup (With RIAA Equalization) .....	542
<b>24-19</b> Preamplifier for Ceramic Phonograph Pickup (Cathode-Follower Output) .....	543
<b>24-20</b> Two-Stage Input Amplifier (Cathode-Follower Output) .....	544
<b>24-21</b> Low-Distortion Preamplifier (For Low-Output, High-Impedance Microphones) .....	544
<b>24-22</b> Bass and Treble Tone-Control Amplifier .....	545
<b>24-23</b> Audio Control Unit (With Volume and Tone Controls) .....	546
<b>24-24</b> VHF Tuner (For Black-and-White TV Receiver) .....	548
<b>24-25</b> Video IF Amplifiers and Sound-Channel Circuits (For Black-and-White TV Receiver) .....	550
<b>24-26</b> Video, AGC, and Sync Amplifiers (For Black-and-White TV Receiver) .....	551
<b>24-27</b> Vertical and Horizontal Deflection Circuits and High-Voltage (For Black-and-White TV Receiver) .....	552
<b>24-28</b> Low-Voltage and Heater Supply (For Black-and-White TV Receiver) .....	553
<b>24-29</b> Sine- Square-Wave Audio Signal Generator .....	554
<b>24-30</b> Electronic Volt-Ohm Meter .....	446
<b>24-31</b> Cathode-Ray Oscilloscope .....	558
<b>24-32</b> All-Purpose Power Supply .....	560



2A-2 AC/DC SUPERHETERODYNE RECEIVER

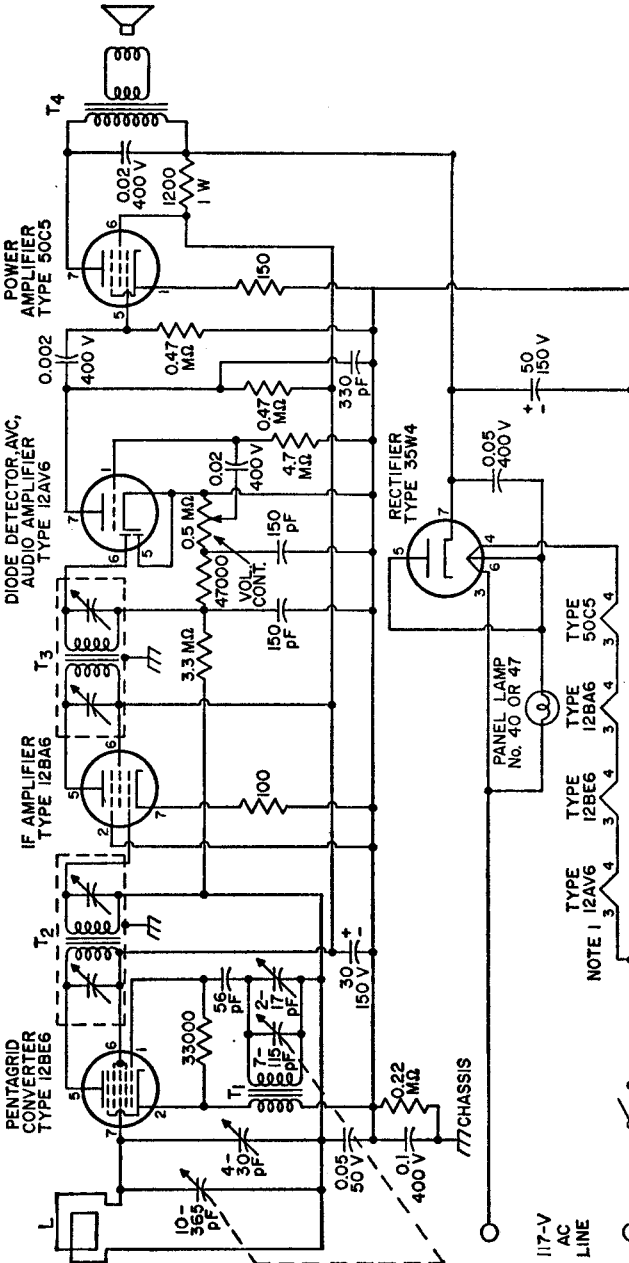

L<sub>1</sub> = Loop antenna or ferrite-rod antenna, 540 to 1600 kc/s (with specified values of tuning and trimmer capacitance)  
 T<sub>1</sub> = Oscillator coil for use with 7- to 455 kc/s (permeability-tuned type may be used)  
 T<sub>2</sub> = Intermediate frequency transformer  
 T<sub>3</sub> = Intermediate frequency transformers (include if trimmer capacitors), impedance of speaker voice coil to 2500-ohm tube plate load

- Notes:**
1. Resistance in ohms and capacitance in microfarads unless otherwise specified.
  2. All resistors 0.5 watt unless otherwise specified.
  3. The following tube types may be used for a 100-mA heater complement: 18FX6A converter, 18FW6A if amplifier, 18FY6A detector and audio amplifier, 34GD5A power amplifier, and 36AM3B rectifier.

NOTE 1  
 TYPE 12AV6  
 TYPE 12BE6  
 TYPE 12BA6  
 TYPE 50C5

24-3 CODE-PRACTICE OSCILLATOR

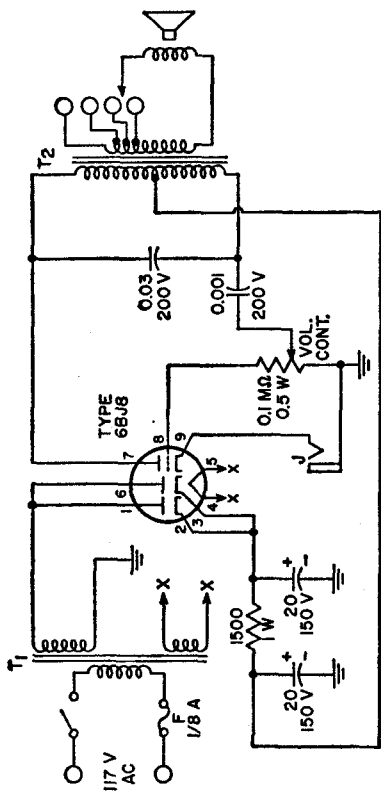

T<sub>1</sub> = Power transformer, 125 volts rms, 15 mA; 6.3 volts, 0.6 ampere

T<sub>2</sub> = Universal output transformer

- Notes: 1. Any two terminals of the secondary of T<sub>2</sub> that give the desired tone may be selected. Adjustment of volume control may cause a slight change in tone.  
 2. Resistance in ohms and capacitance in microfarads unless otherwise specified.



24-4 AM-FM RECEIVER (Cont'd)

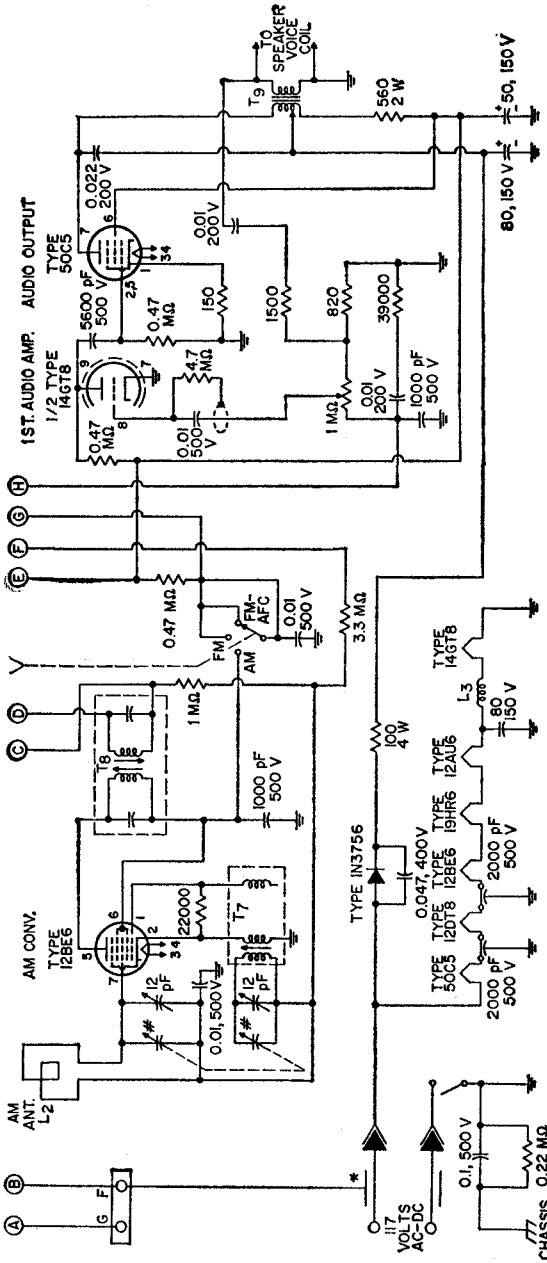

**T<sub>1</sub>** = FM antenna transformer  
**T<sub>2</sub>** = FM oscillator transformer  
**T<sub>3</sub>T<sub>4</sub>** = FM if transformer, 10.7 Mc/s  
**T<sub>5</sub>T<sub>6</sub>** = AM if transformer, 455 kc/s  
**T<sub>7</sub>** = Ratio-detector transformer, 10.7 Mc/s

**L<sub>2</sub>** = AM antenna, air loop with back cover  
**P<sub>C1</sub>** = Printed circuit; includes 0.5-megohm, 0.25-watt resistor and 470-picofarad 500-volt capacitor; RCA Stock No. 104328 or equiv.

**L<sub>1</sub>** = RF coil  
**L<sub>2</sub>** = AM antenna, air loop with back cover  
**P<sub>C1</sub>** = Printed circuit; includes 0.5-megohm, 0.25-watt resistor and 470-picofarad 500-volt capacitor; RCA Stock No. 104328 or equiv.

**Tr** = AM Oscillator coil; with specified values of tuning and trimmer capacitance, tunes to 540 to 1600 kc/s  
**T<sub>8</sub>** = Audio output transformer, matches impedance of speaker voice coil to 2500-ohm tube load.

- Notes:**
1. Resistance in ohms and capacitance in microfarads unless otherwise specified.
  2. All resistors 0.5 watt, ±10% unless otherwise specified.
  3. See general considerations for construction of high-frequency and broadband circuits on page 519.









FM STEREO MULTIPLEX ADAPTER

24-7

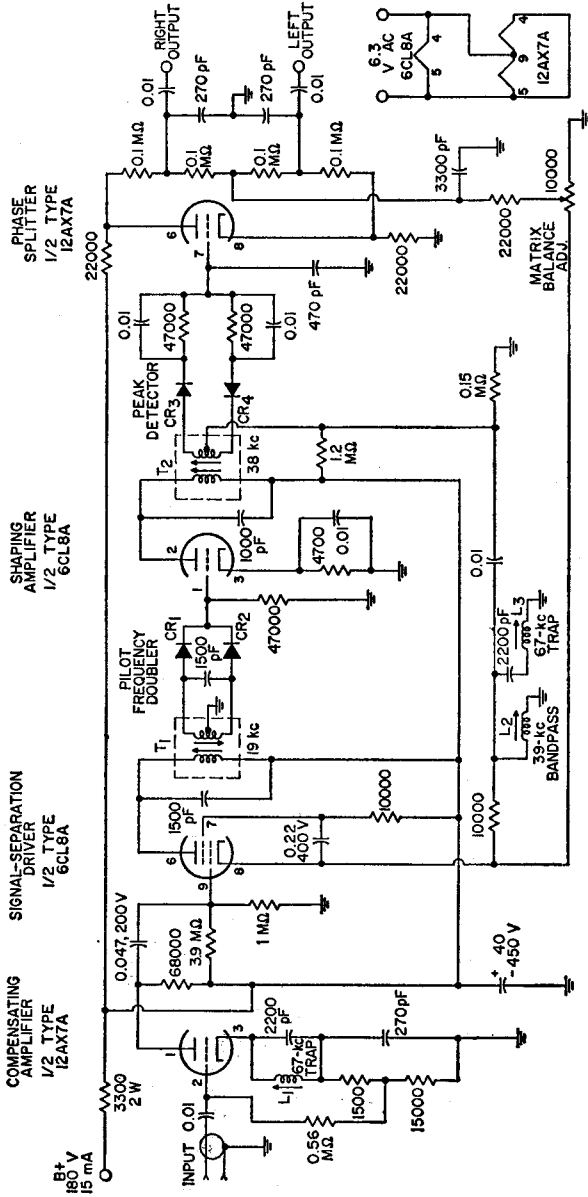

**CR<sub>1</sub>, CR<sub>2</sub>, CR<sub>3</sub>** = Crystal diode, RCA stock No. 111207 or equiv.  
**L<sub>1</sub>** = RF coil, 67-kc/s trap, RCA stock No. 111047 or equiv.  
**L<sub>2</sub>** = RF coil, 39-kc/s band pass, RCA stock No. 111048 or equiv.  
**T<sub>1</sub>** = RF interstage coupling transformer, 19-kc/s, RCA stock No. 111045 or equiv.  
**T<sub>2</sub>** = RF interstage coupling transformer, 38-kc/s, RCA stock No. 111046 or equiv.  
**12AX7A** = Phase splitter  
**6CL8A** = Shaping amplifier  
**6CL8A** = Signal-separation driver  
**12AX7A** = Phase splitter

- Notes:**
1. Resistance in ohms and capacitance in microfarads unless otherwise specified.
  2. All resistors 0.5 watt and all capacitors 500 volts unless otherwise specified.
  3. See general considerations for construction of high-frequency and broadband circuits on page 519.

24-8 FM TUNER

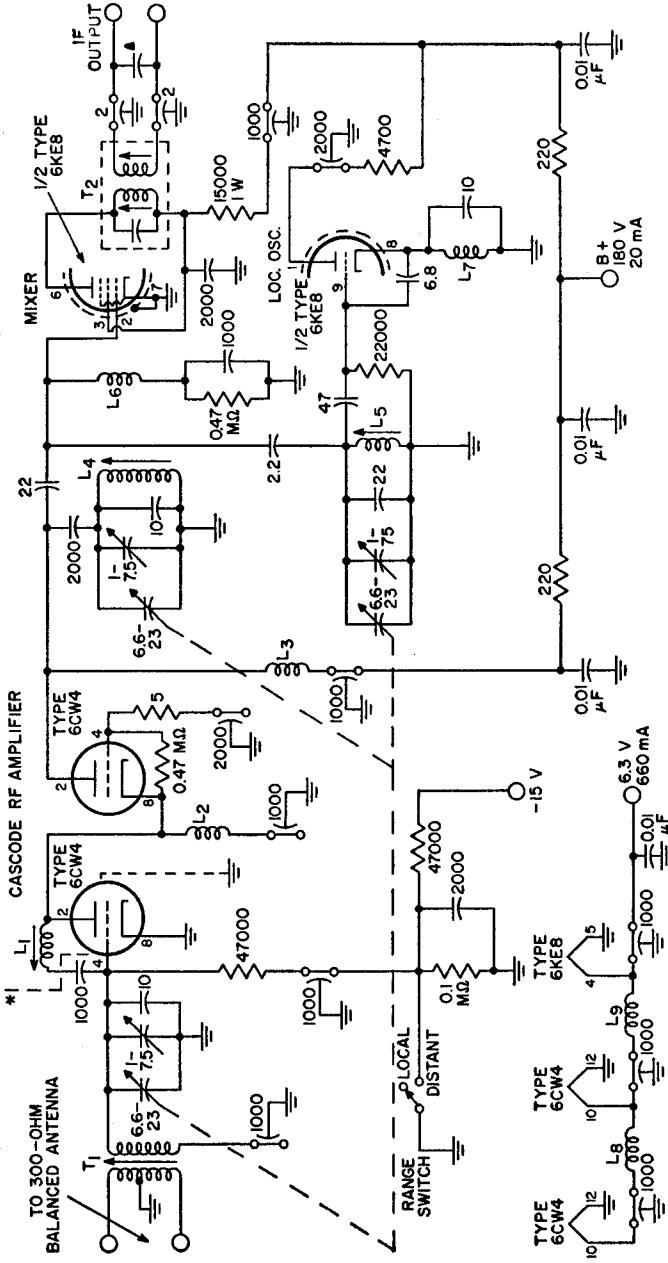

\* A metal shield should be provided between grid and plate terminals on the 6CW4 socket.

▲ Capacitor inserted in place of tuning capacitor in secondary winding of T<sub>1</sub>. Value with cable capacitance tunes output circuit of tuner to 10.7 Mc/s.

## 24-8 FM TUNER (Cont'd)

- L<sub>1</sub>** = RF coil, 12 turns of No. 22 enamel wire close-wound on ¼-inch-diameter slug-tuned coil form; tuning slug = ¾-inch-long Moldite No. 5101 ferrite or equiv.
- L<sub>2</sub>** = RF coil, 5 turns of No. 22 enamel wire close-wound on ¼-inch-diameter coil form
- L<sub>3</sub>** = RF choke, 4  $\mu$ H, J. W. Miller No. 70F396A1 or equiv.
- L<sub>4</sub>** = RF coil, 3 turns of No. 16 enamel wire wound double-spaced on ¼-inch-diameter slug-tuned coil form; tuning slug = ¾-inch-long Moldite No. 5101 ferrite or equiv.
- L<sub>5</sub>** = RF coil, 1½ turns of No. 16 enamel wire close-wound on ¼-inch-diameter slug-tuned coil form; tuning slug = ¾-inch-long Moldite No. 5101 ferrite or equiv.
- L<sub>6</sub>** = RF coil, 2  $\mu$ H; 20 turns of No. 26 enamel wire close-wound on a 0.47 megohm, 0.5w Allen-Bradley resistor or resistor of equivalent physical size
- L<sub>7</sub>** = RF coil; 0.4  $\mu$ H; 25 turns of No. 24 enamel wire close-wound on a 0.47-megohm, 1-watt Allen-Bradley resistor or resistor of equivalent physical size
- L<sub>8</sub>** **L<sub>9</sub>** = RF chokes; 1  $\mu$ H; 25 turns of No. 24 enamel wire close-wound on a 0.47-megohm, 1-watt Allen-Bradley resistor or resistor of equivalent physical size
- T<sub>1</sub>** = Antenna transformer; primary: 2 turns of No. 32 wire with type B nylon insulation, Alpha No. 1860 or equivalent, center-tapped; secondary: 3 turns of No. 16 enamel wire; wound double-spaced on ¼-inch-diameter slug-tuned coil form; tuning slug = ¾-inch-long Moldite No. 5101 ferrite or equiv.
- T<sub>2</sub>** = FM if transformer, 10.7 Mc/s, J. W. Miller 1451 or equiv.; capacitor in secondary should be replaced by one shown connected across tuner output terminals (see footnote  $\Delta$ )

- Notes:** 1. Resistances in ohms and capacitance in picofarads unless otherwise specified.  
 2. All resistors 0.5 watt and all capacitors 400 volts unless otherwise specified.  
 3. See general considerations for construction of high-frequency and broadband circuits on page 519.

### 24-9 THREE-STAGE IF AMPLIFIER/LIMITER AND DETECTOR

For Monaural or Stereo Tuner

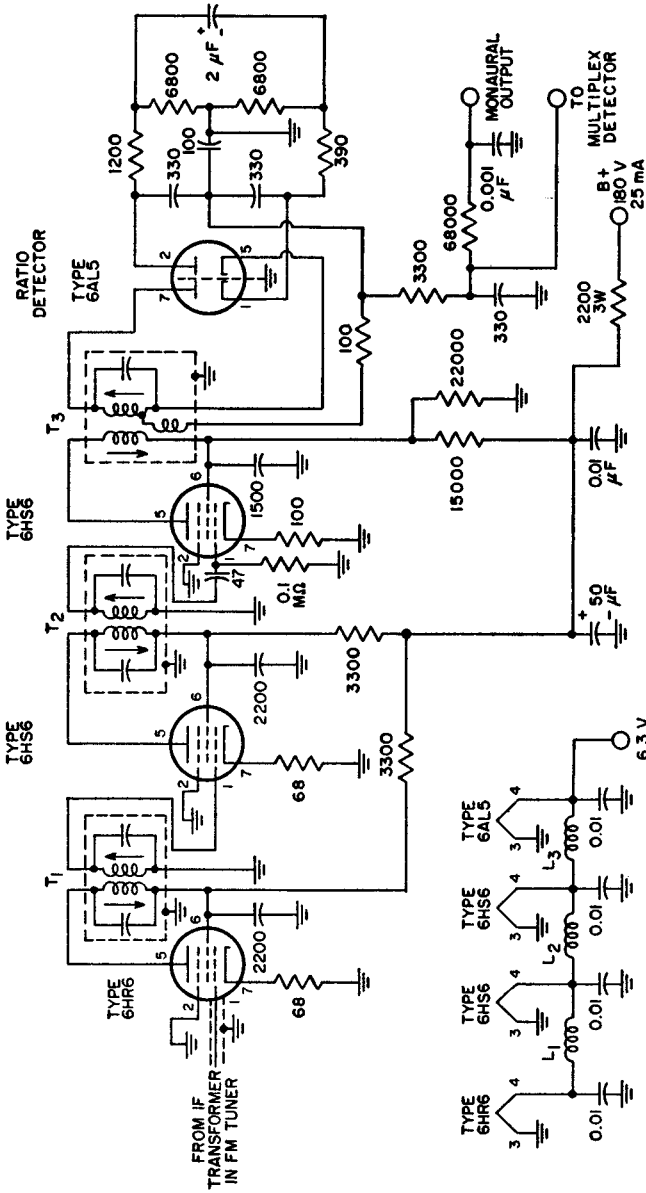

$L_1$   $L_2$   $L_3$  = RF choke, 1  $\mu$ H  
 $T_1$ ,  $T_2$  = IF transformers, 10.7 Mc/s, includes capacitors across primary and secondary windings  
 $T_3$  = Ratio-detector transformer, 10.7 Mc/s, includes capacitor across secondary winding.

- Notes:**
1. Resistances in ohms and capacitance in picofarads unless otherwise specified.
  2. All resistors 0.5 watt and all capacitors 400 volts unless otherwise specified.
  3. Tube shields may be required if regeneration is encountered. See general considerations for construction of high-frequency and broadband circuits on page 519.

### 24-10 INTERCOMMUNICATION SET

With Master Unit and Two or More Remote Units

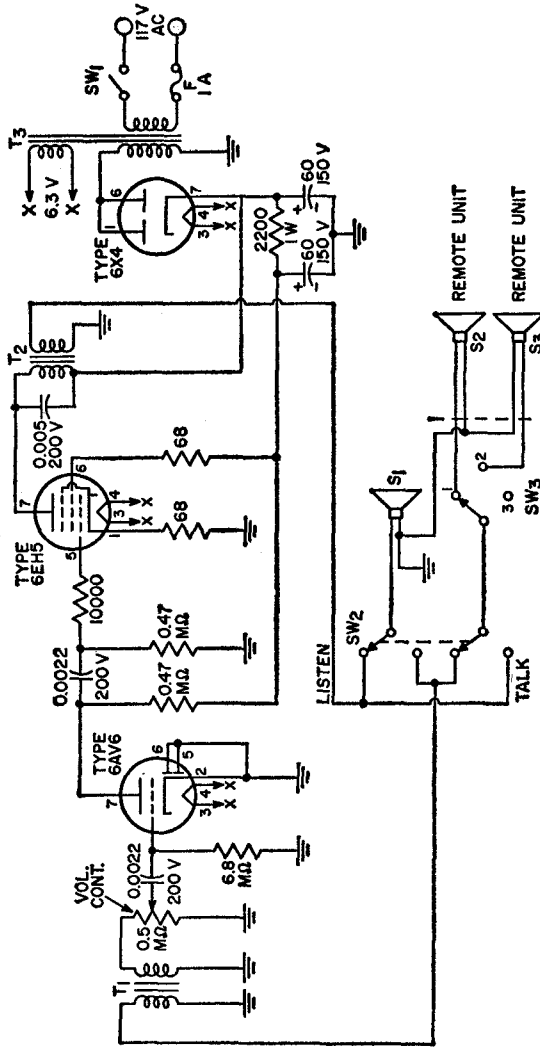

**S<sub>1</sub> S<sub>2</sub> S<sub>3</sub>** = Speaker; permanent-magnet; voice-coil impedance, 3 to 4 ohms  
**SW<sub>1</sub>** = On-off switch, single-pole single-throw, attached to volume control potentiometer  
**SW<sub>2</sub>** = Talk-listen switch, double-throw double-throw  
**SW<sub>3</sub>** = Station Selector, rotary switch  
**T<sub>1</sub>** = Input transformer, 4-ohm primary, 25000-ohm secondary  
**T<sub>2</sub>** = Output transformer, 3000-ohm primary, 4-ohm secondary  
**T<sub>3</sub>** = Power transformer; 125 volts rms, 50 mA; 6.3 volts, 2 amperes.

- Notes:**
1. The leads from the LISTEN-TALK switch to T<sub>1</sub> and T<sub>2</sub> should be kept as far apart as possible to prevent undesirable regenerative effects.
  2. Connections to the remote speaker units should be made with low-resistance wire, preferably with shielded "intercom" cable.
  3. Resistance in ohms and capacitance in microfarads unless otherwise specified.
  4. All resistors 0.5 watt unless otherwise specified.
  5. Potentiometer should have audio taper.







24-13 HIGH-FIDELITY AUDIO AMPLIFIER

Class AB<sub>1</sub>; Power Output, 50 watts

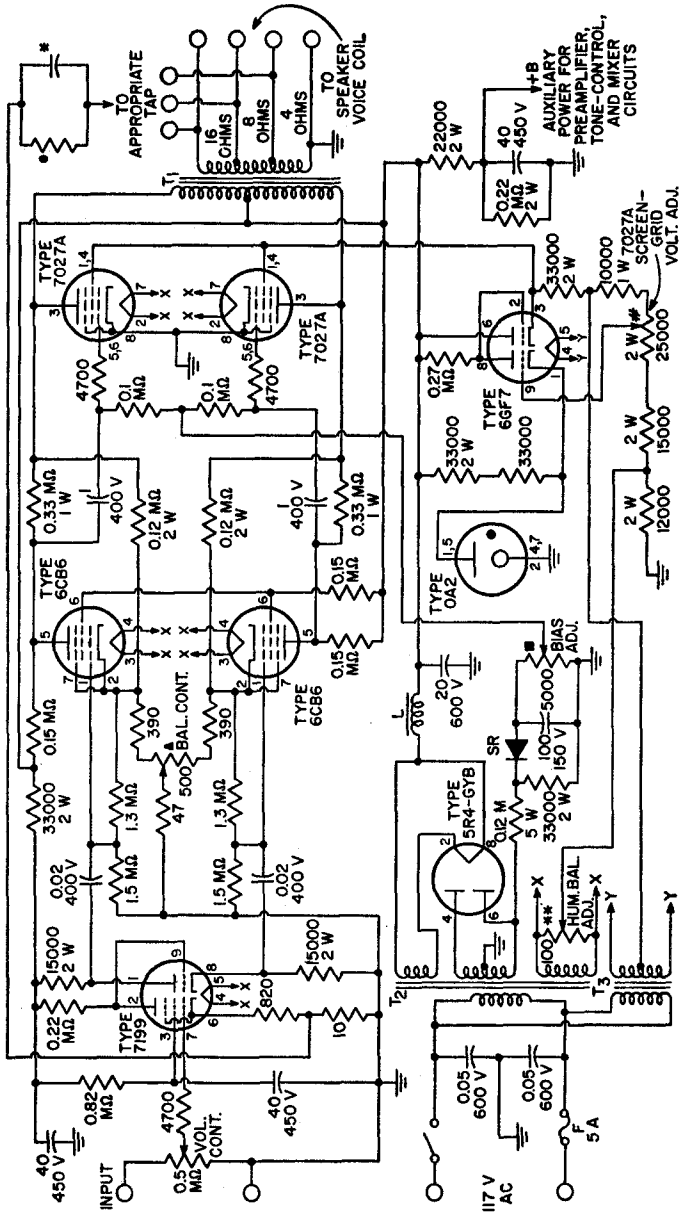

- Notes:
1. Resistance in ohms and capacitance in microfarads unless otherwise specified.
  2. All resistors 0.5 watt, ±10% unless otherwise specified.
  3. Potentiometers should have audio taper.
  4. If amplifier oscillates or "motorboats," reverse ground and feedback connections in secondary of output transformer T<sub>1</sub>.

- \* Capacitor = 0.002  $\mu$ F when connected to 4-ohm transformer tap, 0.0015  $\mu$ F when connected to 8-ohm tap, or 0.001  $\mu$ F when connected to 16-ohm tap, 400 volts.
- Resistor = 600 ohms when connected to 4-ohm transformer tap, 820 ohms when connected to 8-ohm tap, or 1200 ohms when connected to 16-ohm tap, 0.5 watt.

L = Filter choke; 8H; 250 mA; dc resistance, 60 ohms or less  
 SR = Selenium rectifier, 20 mA, 135 volts rms

T<sub>1</sub> = Audio output transformer; matches impedance of speaker voice coil to 5000-ohm plate-to-plate tube load; 50 watts; frequency response, 10 to 50000

c/s; Acrosecond TQ340 or equiv.  
 T<sub>2</sub> = Power transformer; 600-0-600 volts rms, 200 mA; 6.3 volts, 5 amperes; 5 volts, 3 amperes; Thordarson 22R36 or equiv.

T<sub>3</sub> = Filament transformer; 6.3 volts, center-tapped, 1 ampere; Thordarson 21F08 or equiv.

#### Preliminary Adjustments

The following adjustments should be made before operation:

- (\*) With rectifier out of socket, adjust Bias Adj. for -40 volts between the wiper arm and ground bus.
- (#) With speaker connected, adjust Screen-Grid Voltage Adj. for 400 volts between pin 2 of 6GF7 and ground bus.
- (\*\*) With input shorted, adjust Hum Bal. Adj. for minimum hum from speaker.
- (†) With input open and Vol. Cont. set for maximum volume, adjust Bal. Cont. for minimum hum from speaker.

Performance Specifications	10 to 50000 c/s
Sensitivity = 0.4 volt rms input for 50 watts output	Total harmonic distortion = 0.1%
Hum and noise = 70 dB below 50 watts with input shorted	Intermodulation distortion = 1%
Freq. response = flat $\pm$ 1 dB from	at 50 watts

**24-14 TWO-CHANNEL AUDIO MIXER**

Voltage Gain from Each Grid of 6EU7 to Output is Approximately 20

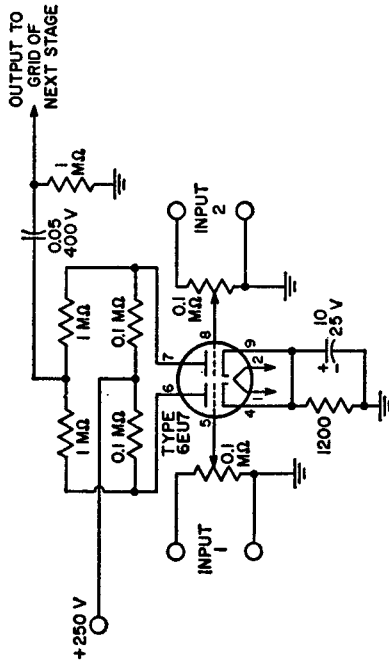

- Notes:**
1. Resistance in ohms and capacitance in microfarads unless otherwise specified.
  2. All resistors 0.5 watt unless otherwise specified.
  3. Potentiometers should have audio taper.

## 24-15 TWO-CHANNEL STEREPHONIC AMPLIFIER

Power Output, 1 Watt Each Channel

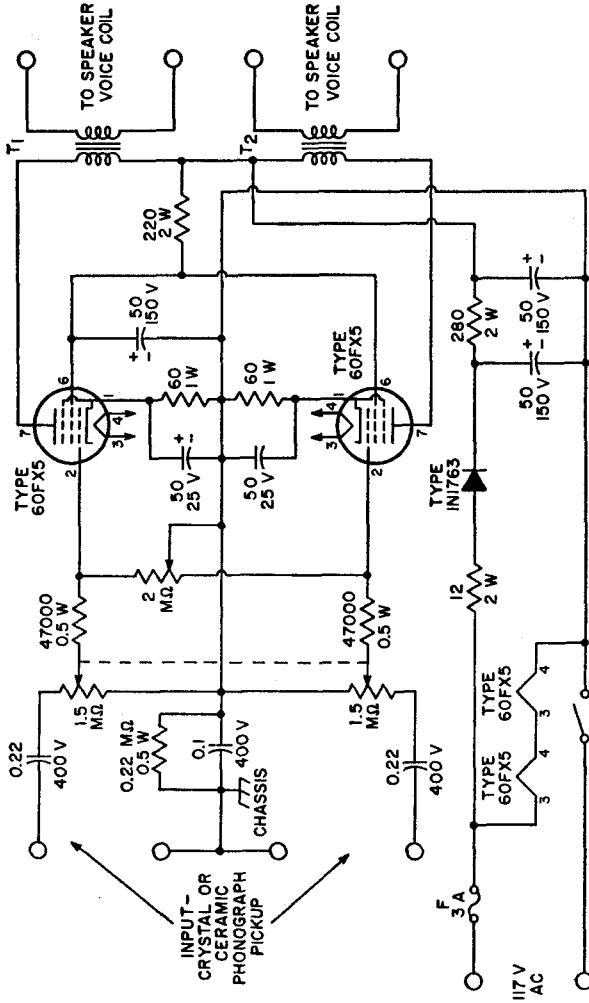

T<sub>1</sub> T<sub>2</sub> = Audio output transformer, matches impedance of speaker voice coil to 3000-ohm tube plate load, Triad S-16X or equiv.

- Notes: 1. Resistance in ohms and capacitance in microfarads unless otherwise specified.  
 2. Potentiometers should have audio taper.









24-19

**PREAMPLIFIER FOR CERAMIC PHONOGRAPH PICKUP**

Cathode Follower (Low-Impedance) Output

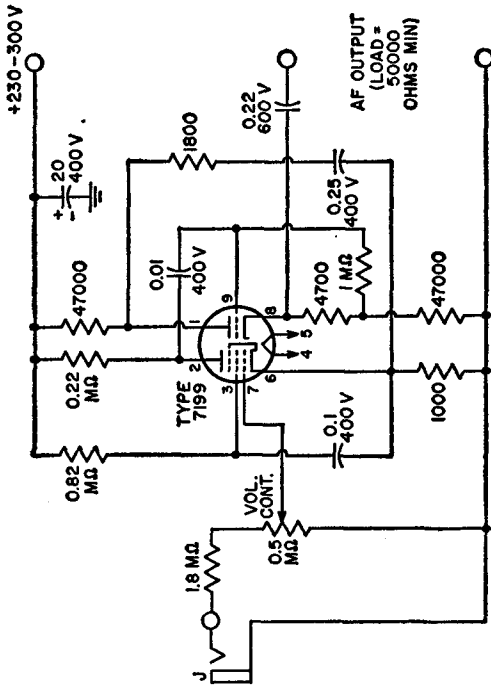

**J** = Input connector, shielded, for high-impedance ceramic phono pickup (0.5 volt output)

- Notes:** 1. Resistance in ohms and capacitance in microfarads unless otherwise specified.  
 2. All resistors 0.5 watt unless otherwise specified.  
 3. Potentiometer should have audio taper.

## 24-20

**TWO-STAGE INPUT AMPLIFIER**

Cathode-Follower (Low-Impedance) Output

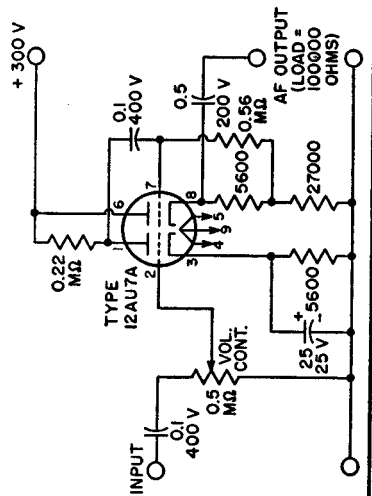

- Notes:**
1. Resistance in ohms and capacitance in microfarads unless otherwise specified.
  2. All resistors 0.5 watt unless otherwise specified.
  3. Potentiometer should have audio taper.

## 24-21

**LOW-DISTORTION PREAMPLIFIER**

For Low-Output, High-Impedance Microphones

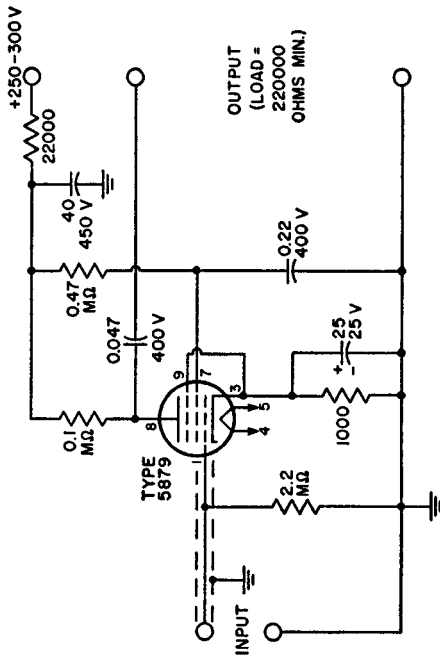

- Sensitivity** = 3 millivolts rms input for output of 220 millivolts.
- Notes:**
1. Resistance in ohms and capacitance in microfarads unless otherwise specified.
  2. All resistors 0.5 watt unless otherwise specified.





## TELEVISION CIRCUITS 24-24 to 24-28

Circuits 24-24 through 24-28 are essentially identical to the corresponding circuits in the RCA-KCS-152 Television Receiver. These circuits comprise a complete television receiver with the exception of the deflection coils and the picture tube. Portions of any television receiver, however, are required to operate over an extremely wide range of very high frequencies. The construction of such circuits requires more than ordinary skill and experience and the use of sophisticated test equipment (see general consideration for the construction of high-frequency and broadband circuits on page 519). Home construction of such circuits is not recommended unless the builder has had considerable experience in this type of work.

The chassis of circuits 24-24 through 24-28 are connected to one side of the ac line during operation. Servicing of these circuits should not be attempted by persons not familiar with the precautions necessary when working on this type of equipment.

1. An isolation transformer should be inserted between the receiver and the ac line before any servicing is attempted.
2. If the receiver must be operated directly from the ac supply, the power plug should be inserted in the proper direction to connect the chassis to the ground side of the ac line. Use an ac voltmeter to measure the voltage between the chassis and the power-source ground; no voltage reading should be obtained. If a reading is obtained, reverse the power plug, and recheck for a zero reading.

**For further information on television circuits, the reader should consult the text sections in this manual**



GIMMICK = Trimmer-capacitor plate  
 L<sub>1</sub> L<sub>2</sub> L<sub>3</sub> = RF coils; with two 82-pico-farad capacitors, forms high-pass filter (antenna input network), RCA Stock No. 114458 or equiv.  
 L<sub>4</sub> = RF amplifier grid coil, part of S<sub>3</sub> assembly  
 L<sub>5</sub> = Mixer grid coil, part of S<sub>2</sub> assembly  
 L<sub>6</sub> = Interstage coupling coil for rf amplifier and mixer, part of S<sub>2</sub> assembly  
 L<sub>7</sub> through L<sub>17</sub> = RF-amplifier tuning coils, part of S<sub>2</sub> assembly  
 L<sub>18</sub> through L<sub>29</sub> = Mixer tuning coils, part of S<sub>2</sub> assembly  
 L<sub>30</sub> = Variable rf coil; mixer plate tuning adjustment; RCA stock No. 112909 or equiv.  
 L<sub>31</sub> = RF choke

L<sub>32</sub> = Variable rf coil; local-oscillator tuning adjustment for channel 13  
 L<sub>33</sub> through L<sub>39</sub> = Local-oscillator tuning coils (variable coil L<sub>39</sub> is tuning adjustment for channel 6), part of S<sub>1</sub> assembly  
 L<sub>44</sub> = Variable rf coil; fine-tuning control; RCA Stock No. 113323, or equiv.  
 S<sub>1</sub> = Local-oscillator section of channel-selector switch; stator assembly, RCA Stock No. 114462 or equiv., includes local-oscillator tuning coils L<sub>33</sub> through L<sub>43</sub>  
 S<sub>2</sub> = Mixer section of channel-selector switch; stator assembly, RCA Stock No. 114461 or equiv., includes mixer tuning coils L<sub>6</sub>, L<sub>9</sub>, and L<sub>15</sub> through L<sub>29</sub>

S<sub>3</sub> = RF amplifier section of channel-selector switch; stator assembly, RCA Stock No. 114460 or equiv., includes rf-amplifier tuning coils L<sub>1</sub> and L<sub>7</sub> through L<sub>17</sub>  
 S<sub>4</sub> = VHF-UHF function selector; two-section switch ganged with channel selectors S<sub>1</sub>, S<sub>2</sub>, and S<sub>3</sub>; RCA Stock No. 114185 or equiv.  
 T<sub>1</sub> = Antenna-matching balun; matches 300-ohm balanced antenna-lead line to 75-ohm unbalanced receiver-input line; RCA Stock No. 111973 or equiv.  
 T<sub>2</sub> = Antenna transformer; RCA Stock No. 113195 or equiv.  
 Z<sub>1</sub> Z<sub>2</sub> = Resistance-capacitance network (capacitor), RCA stock No. 109956 or equiv.

- Notes:** 1. All switches are ganged together on same shaft and are shown with shaft in channel 13 position.  
 2. Resistance values in ohms and capacitance values in picofarads, unless otherwise specified.  
 3. All resistors 0.5 watt  $\pm 10\%$  and all capacitors 500 volt unless otherwise specified.  
 4. Voltages shown are obtained with no signal input.  
 5. For dc voltage and heater supply, see circuit 24-28, page 553.  
 6. See additional notes on page 547.

24-25 VIDEO IF AMPLIFIERS AND SOUND-CHANNEL CIRCUITS

For Black-and-White Television Receiver

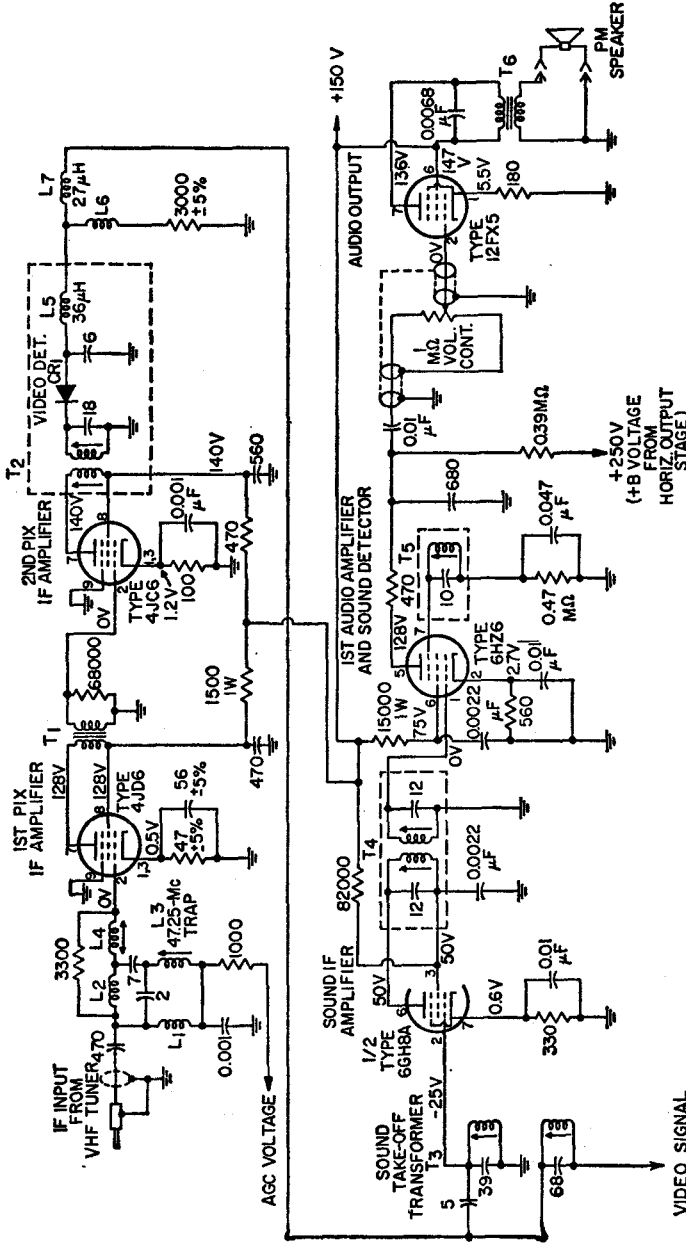

- Notes:**
1. Resistance in ohms and capacitance in picofarads unless otherwise specified.
  2. All resistors 0.5 watt unless otherwise specified.
  3. Voltages shown are obtained with no signal input.
  4. For dc voltage and heater supply, see circuit 24-28, page 553.
  5. See additional notes on page 547.







### 24-27 VERTICAL AND HORIZONTAL DEFLECTION CIRCUITS AND HIGH-VOLTAGE RECTIFIER (Cont'd)

**L<sub>1</sub>** = Oscillator coil, RCA Stock No. 114486 or equiv.  
**L<sub>2</sub>** = RF chokes (reactors), 8.2  $\mu$ H, RCA Stock No. 107385 or equiv.  
**PC** = Printed circuit (includes 0.001- $\mu$ F and 0.0024- $\mu$ F capacitors and 68000-ohm resistor), RCA Stock No. 114506 or equiv.  
**SR** = Selenium rectifier, RCA Stock No. 109474 or equiv.  
**T<sub>1</sub>** = High-voltage and horizontal-output transformer, RCA Stock No. 114498 or equiv.  
**T<sub>2</sub>** = Vertical-output transformer, RCA Stock No. 114502 or equiv.

- Notes:** 1. Resistance in ohms and capacitance in microfarads unless otherwise specified.  
 2. All resistors 0.5 watt unless otherwise specified.  
 3. Voltages shown are obtained with no signal input.  
 4. For dc voltage and heater supply, see circuit below.  
 5. See additional notes on page 547.

### 24-28 LOW-VOLTAGE AND HEATER SUPPLY FOR BLACK-AND-WHITE TELEVISION RECEIVER

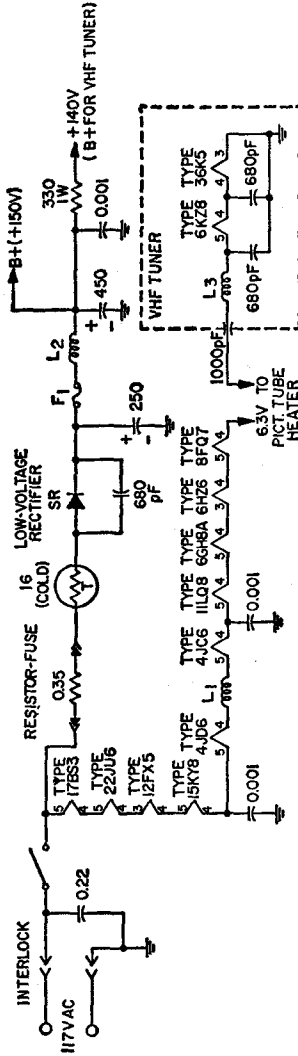

**L<sub>1</sub>** = RF choke, part of heater printed-circuit bond, RCA Stock No. 114499 or equiv. (Includes two 0.001- $\mu$ F capacitors)  
**L<sub>2</sub>** = Filter choke (reactor), RCA Stock No. 114501 or equiv.  
**L<sub>3</sub>** = RF choke for VHF tuner filament circuit  
**Resistor-fuse** = 0.35-ohm, RCA Stock No. 114481 or equiv.  
**SR** = Silicon rectifier, Type 1N3194  
**Thermistor (T)** = Surge-protection resistor, 16 ohms (cold), RCA Stock No. 114480 or equiv.

- Notes:** 1. Resistance in ohms and capacitance in microfarads unless otherwise specified.  
 2. See additional notes on page 547.



## 24-29 SINE- SQUARE-WAVE AUDIO SIGNAL GENERATOR (Cont'd)

▲ On each range, the frequency of the generator is adjusted by means of a variable two-gang capacitor, RCA stock No. 220226 or equiv.

- I**<sub>1</sub> = Lamp, 3 watts, 120 volts  
**I**<sub>2</sub> = Pilot lamp, No. 47  
**L**<sub>1</sub> = Filter choke (reactor), RCA stock No. 220215 or equiv.  
**S**<sub>1</sub> = Rotary switch; sine-square attenuation selector; 8 positions, 3 wafers; RCA stock No. 220216 or equiv.  
**S**<sub>2</sub> = Rotary switch; frequency range selector; 4 positions, 2 wafers; RCA stock No. 220217 or equiv.  
**S**<sub>3</sub> = On-Off switch.  
**T**<sub>1</sub> = Power transformer; 117 volts rms, 60 c/s; RCA stock No. 220214 or equiv.

## SWITCH POSITIONS

S1 Frequency Range	S2 Sine/Square	
1—X1	1—Sine X10	5—Square X0.01
2—X10	2—Sine X1	6—Square X0.1
3—X100	3—Sine X0.1	7—Square X1
4—X1000	4—Sine X0.01	8—Square X10

**Frequency Ranges:** 20 to c/s; 200 to 2000 c/s; 2000 to 20000 c/s; 20000 to 200000 c/s.  
**Sine-Wave Output:** 0 to 8 volts rms.  
**Square-Wave Output:** 0 to 10 volts, peak.

- Notes:** 1. "Sine-Square Attenuator" **S**<sub>1</sub>, shown in "X10" position.  
 2. "Freq. Range" selector, **S**<sub>2</sub>, shown in "X1" position.  
 3. Resistance in ohms and capacitance in microfarads unless otherwise specified.  
 4. DC voltages shown are measured between points indicated and ground with a vacuum-tube voltmeter.

This audio generator is similar to the RCA type WA-44C.



24-30

## ELECTRONIC VOLT-OHM METER (Cont'd)

CR<sub>1</sub> = Selenium rectifier, Radio Receiver Co. No. 8Y1B or equiv.

M<sub>1</sub> = Meter, dc, 0-200 microamperes

S<sub>1</sub> = Range selector, 7-position rotary switch, RCA stock No. 217924 or equiv.

S<sub>2</sub> = Function selector, 5-position rotary switch, RCA stock No. 217923 or equiv.

T<sub>1</sub> = Power transformer, 105 to 125 volts rms, 50 to 60 cycles per second, RCA stock No. 217921 or equiv.

- Notes:** 1. Switches are shown in their maximum counterclockwise positions (S<sub>1</sub> = 1.5 V, R X 1; S<sub>2</sub> = "OFF").
2. Resistance in ohms and capacitance in microfarad unless otherwise specified.
3. All resistors 0.5-watt and all capacitor 400-volt unless otherwise specified. For home construction of this or a similar circuit, the complete Kit-WV-77E(K) or RCA-WV-98C(K) is recommended because of the large number of special components used.
4. DC voltages shown are measured with respect to circuit ground unless otherwise indicated, under following conditions: ac line voltage, 117 volts; Function selector S<sub>2</sub> at "+ DC"; Range Switch S<sub>1</sub> at "1500 V."







ALL-PURPOSE POWER SUPPLY

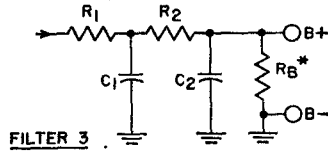
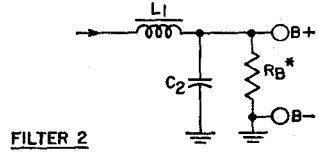
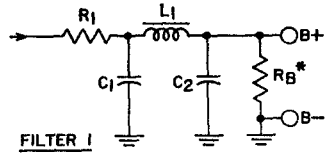
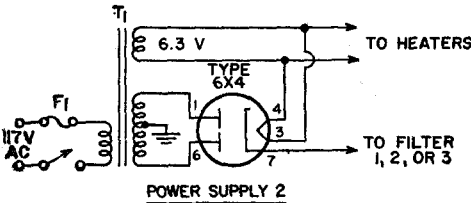
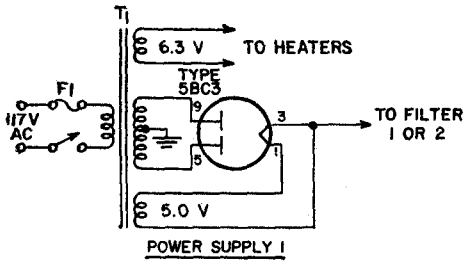

POWER SUPPLY	TRANS-FORMER	CHOKE (L <sub>1</sub> )	R <sub>1</sub>	R <sub>2</sub>	C <sub>1</sub> , C <sub>2</sub>	FIL-TER	OUTPUT VOLTS	mA
1 (5BC3)	Stancor PC or PM 8177 (300-0-300) or equiv.	140 mA, 7H, 165 ohms Stancor C1421 or equiv.	33 ohms 5W	—	40 μF 450 Vdc	1	360	60
							340	80
							320	120
						2	235	60
							230	80
							215	120
1 (5BC3)	Stancor PC or PM 8412 (400-0-400) or equiv.	200 mA, 4H, 145 ohms Thordarson 20C54 or equiv.	56 ohms 10W	—	40 μF 600 Vdc	1	450	120
							425	160
							410	200
						2	310	120
							300	160
							280	200
2 (6X4)	Stancor P-6358 (300-0-300) or equiv.	80 mA, 12H, 375 ohms Thordarson 20C53 or equiv.	500 ohms 5W	500 ohms 3W	40 μF 450 Vdc	1	350	20
							300	40
							260	60
						2	250	20
							230	40
							220	60
						3	345	20
							300	40
							250	60
2 (6X4)	Stancor PM or PC 8419 (240-0-240) or equiv.	80 mA, 12H, 375 ohms Thordarson 20C53 or equiv.	500 ohms 5W	500 ohms 3W	40 μF 450 Vdc	1	265	20
							225	40
							190	60
						2	200	20
							180	40
							170	60
						3	260	20
							220	40
							180	60

\* Bleeder R<sub>b</sub> can be omitted if an external load is permanently connected across the output terminals. Bleeder current should be approximately 10 per cent of the load current.

## Index to RCA Receiving Tubes

0Z4	450	1LN5	452	3AU6	134
0Z4G	450	1N2A	452	3AV6	137
1A3	450			3AW3	99
1A4P	450	1N5GT	452	3B2	454
1A5GT	450	1N6G	452	3BA6	146
		1P5GT	454		
1A6	450	1Q5GT	454	3BC5	151
1A7GT	450	1R5	454	3BE6	154
1AC5	450			3BN4	454
1AD2	93	1S4	454	3BN4A	168
1AD5	450	1S5	454	3BN6	168
		1T4	454		
1AX2	450	1T5GT	454	3BU8	175
1B3GT	450	1T6	454	3BY6	178
1B4P	450			3BZ6	180
1B5/25S	450	1U4	454	3CA3	99
1B7GT	450	1U5	454	3CB6	189
		1V	454		
1C5GT	450	1V2	95	3CE5	192
1C6	450	1X2A	454	3CF6	192
1C7G	450			3CS6	201
1D5GP	450	1X2B	96	3CY5	207
1D5GT	450	2A3	454	3DG4	100
		2A5	454		
1D7G	450	2A6	454	3DK6	218
1D8GT	450	2A7	454	3DT6	454
1DN5	450			3DT6A	227
1E5GP	452	2AF4A	454	3DZ4	232
1E7GT	452	2AF4B	115	3EA5	233
		2AH2	96		
1E8	452	2AS2	97	3EH7	240
1F4	452	2AV2	97	3EJ7	240
1F5G	452			3ER5	245
1F6	452	2B7	454	3FH5	257
1F7G	452	2BJ2	98	3GK5	276
		2BN4	454		
1G3GT/1B3GT	94	2BN4A	168	3GS8	101
1G4GT	452	2CW4	204	3GS8/3BU8	454
1G5G	452			3HA5	295
1G6GT	452	2CY5	207	3HM5/3HA5	306
1H4G	452	2DS4	224	3HQ5	307
		2DV4	229		
1H5GT	452	2DZ4	232	3HS8	310
1H6G	452	2E5	454	3JC6	318
1J3	452			3JD6	320
1J5G	452	2EN5	454	3LF4	454
1J6G	452	2ER5	245	3Q4	454
		2FH5	257		
1J6GT	452	2FS5	264	3Q5GT	454
1K3	452	2GK5	276	3S4	454
1K3/1J3	95			3V4	454
1L6	452	2GU5	283	4AU6	134
1LA4	452	2HA5	295	4AV6	137
		2HQ5	307		
1LA6	452	3A2	454	4BC5	456
1LB4	452	3A3	454	4BC8	152
1LC5	452			4BL8	166
1LC6	452	3A3/3B2	98	4BL8/6XF80	166
1LD5	452	3A8GT	454	4BN6	168
		3AF4A	115		
1LE3	452	3AL5	120	4BQ7A	172
1LG5	452	3AT2	99	4BS8	174
1LH4	452			4BU8	175

4BZ6	180	5FV8	265	6AK5	119
4BZ7	182	5GH8	273	6AK5/EF95	119
4CB6	189	5GM6	280	6AL3	120
4CS6	201	5GX6	288	6AL5	120
4CY5	207	5GX7	290	6AL7GT	458
4DE6	215	5HA7	108	6AL11	121
4DK6	418	5HB7	296	6AM4	458
4DT6	456	5HG8	302	6AM8	458
4DT6A	227	5J6	314	6AM8A	122
4EH7	240	5LJ8	109	6AN4	124
4EJ7	240	5KD8	340	6AN8	458
4ES8	246	5KE8	341	6AN8A	124
4EW6	250	5T4	456	6AQ5	458
4GK5	276	5T8	372	6AQ5A	126
4GM6	280	5U4G	456	6AQ6	458
4GS8/4BU8	456	5U4GB	109	6AQ7GT	458
4GSH	456	5U8	372	6AQ8	128
4GX7	290	5V3	456	6AQ8/ECC85	128
4GZ5	293	5V3A	111	6AR5	458
4HA5	295	5V4G	112	6AR11	129
4HA7	108	5V4GA	112	6AS5	130
4HC7	102	5V6GT	375	6AS8	130
4HM6	306	5W4	456	6AS11	458
4HS8	310	5W4GT	456	6AT6	132
4HT6	103	5X4G	456	6AT8	458
4JC6	318	5X8	381	6AT8A	132
4JD6	320	5Y3G	456	6AU4GT	458
5AM8	122	5Y3GT	113	6AU4GTA	133
5AN8	124	5Y4G	456	6AU5GT	133
5AQ5	126	5Y4GA	456	6AU6	458
5AR4/GZ34	103	5Y4GT	456	6AU6A	134
5AS4	456	5Z3	456	6AU7	460
5AS4A	104	5Z4	456	6AU8	460
5AS8	130	6A3	456	6AU8A	136
5AT8	132	6A6	456	6AV5GA	137
5AU4	456	6A7	458	6AV5GT	460
5AV8	104	6A7S	458	6AV6	137
5AW4	456	6A8	458	6AW8	460
5AZ4	456	6A8G	458	6AW8A	139
5B8	105	6A8GT	458	6AX3	141
5BC3	106	6A84	115	6AX4GT	460
5BC3A	106	6AB5/6N5	458	6AX4GTB	141
5BE8	456	6AB7	458	6AX5GT	142
5BK7A	165	6AC5GT	458	6AX8	460
5BQ7A	172	6AC7	458	6AY3	143
5BR8	173	6AD6G	458	6AY3B	143
5BT8	456	6AD7G	458	6AY11	460
5BW8	177	6AE5GT	458	6AZ8	144
5CG8	193	6AE6G	458	6B4G	460
5CL8	456	6AE7GT	458	6B5	460
5CL8A	195	6AF3	115	6B6G	460
5CM8	456	6AF4	115	6B7	460
5CQ8	199	6AF4A	115	6B7S	460
5CZ5	209	6AF6G	117	6B8	460
5DH8	456	6AF11	117	6B8G	460
5DI4	107	6AG5	118	6B10	145
5EA8	235	6AG7	118	6BA3	146
5EU8	249	6AG11	119	6BA6	146
5EW6	250	6AH4GT	458	6BA7	148
5FG7	257	6AH6	458	6BA8A	149

6BA11 .....	150	6BZ7 .....	182	6DG6GT .....	217
6BC4 .....	150	6BZ8 .....	462	6DK6 .....	218
6BC5 .....	151	6C4 .....	183	6DM4 .....	462
6BC7 .....	152	6C5 .....	462	6DM4A .....	219
6BC8 .....	152	6C5GT .....	462	6DN6 .....	462
6BD4 .....	460	6C6 .....	462	6DN7 .....	220
6BD4A .....	460	6C7 .....	462	6DQ4 .....	220
6BD6 .....	460	6CG8 .....	462	6DQ5 .....	220
6BD11 .....	153	6C9 .....	184	6DQ6A .....	462
6BE3 .....	154	6C10 .....	185	6DQ6B .....	222
6BE6 .....	154	6CA4 .....	185	6DR7 .....	223
6BF5 .....	460	6CA5 .....	186	6DS4 .....	224
6BF6 .....	460	6CA7 .....	187	6DS5 .....	226
6BF11 .....	156	6CA7/EL34 .....	187	6DT5 .....	227
6BG6G .....	460	6CB5 .....	462	6DT6 .....	462
6BG6GA .....	460	6CB5A .....	188	6DT6A .....	227
6BH3 .....	157	6CB6 .....	189	6DT8 .....	229
6BH3A .....	157	6CB6A .....	189	6DV4 .....	229
6BH6 .....	158	6CD6G .....	462	6DW4 .....	231
6BH8 .....	159	6CD6GA .....	190	6DW4B .....	231
6BH11 .....	159	6CE5 .....	192	6DW5 .....	462
6BJ3 .....	161	6CF6 .....	192	6DX8 .....	231
6BJ6 .....	161	6CG7 .....	193	6DZ4 .....	232
6BJ7 .....	162	6CG8 .....	462	6DZ7 .....	462
6BJ8 .....	162	6CG8A .....	193	6E5 .....	233
6BK4 .....	460	6CH8 .....	462	6E6 .....	462
6BK4A .....	164	6CK4 .....	462	6E7 .....	462
6BK4B .....	164	6CL6 .....	194	6EA5 .....	233
6BK5 .....	460	6CL8 .....	462	6EA7 .....	234
6BK7A .....	460	6CL8A .....	195	6EA8 .....	235
6BK7B .....	165	6CM6 .....	196	6EB8 .....	236
6BL4 .....	460	6CM7 .....	196	6EH5 .....	238
6BL7GT .....	460	6CM8 .....	462	6EH7 .....	240
6BL7GTA .....	166	6CN7 .....	198	6EH7/EF183 .....	240
6BL8 .....	166	6CQ4 .....	199	6EH8 .....	464
6BL8/ECF80 .....	166	6CQ8 .....	199	6EJ7 .....	240
6BM8/ECL82 .....	167	6CR6 .....	200	6EJ7/EF184 .....	240
6BN4 .....	460	6CS6 .....	201	6EM5 .....	241
6BN4A .....	168	6CS7 .....	202	6EM7 .....	243
6BN6 .....	168	6CU5 .....	203	6EQ7 .....	244
6BN8 .....	169	6CU6 .....	203	6ER5 .....	245
6BQ5 .....	170	6CU8 .....	203	6ES5 .....	246
6BQ6GT .....	460	6CW4 .....	204	6ES8 .....	246
6BQ6GTB/6CU6 .....	171	6CW5 .....	206	6ET7 .....	247
6BQ7 .....	460	6CX8 .....	207	6EU7 .....	248
6BQ7A .....	172	6CY5 .....	207	6EU8 .....	249
6BR8 .....	460	6CY7 .....	208	6EV5 .....	250
6BR8A .....	173	6CZ5 .....	209	6EV7 .....	464
6BS3 .....	174	6D6 .....	462	6EW6 .....	250
6BS3A .....	174	6D7 .....	462	6EW7 .....	252
6BS8 .....	174	6D8G .....	462	6EX6 .....	464
6BU8 .....	175	6D10 .....	210	6EY6 .....	464
6BV8 .....	460	6DA4 .....	211	6EZ5 .....	464
6BW4 .....	462	6DB5 .....	211	6EZ8 .....	253
6BW8 .....	177	6DC6 .....	212	6F5 .....	464
6BX7GT .....	462	6DC8 .....	462	6F5GT .....	464
6BY5GA .....	462	6DC8/EBF89 .....	213	6F6 .....	253
6BY6 .....	178	6DE4 .....	214	6FGG .....	464
6BY8 .....	179	6DE6 .....	215	6FGT .....	464
6BZ6 .....	180	6DE7 .....	216	6F7 .....	464

6F8G	464	6HB6	296	6K8G	466
6FA7	254	6HB7	296	6K8GT	466
6FD7	256	6HE5	298	6K11	466
6FE5	464	6HF5	299	6K11/6Q11	337
6FG6	257	6HF8	300	6KA8	338
6FG7	257	6HG5	301	6KD8	340
6FH5	257	6HG8	302	6KE8	341
6FH8	258	6HG8/ECF86	302	6KL8	466
6FJ7	260	6HJ5	303	6KM6	342
6FM7	260	6HJ8	303	6KM8	344
6FM8	261	6HK5	304	6KR8	346
6FQ5A	262	6HL8	305	6KT8	347
6FQ7	464	6HM5/6HA5	306	6KU8	348
6FQ7/6CG7	262	6HM6	306	6KV8	349
6FS5	264	6HQ5	307	6KY8	350
6FV6	264	6HR6	308	6KY8A	350
6FV8	464	6HS6	309	6KZ8	352
6FV8A	265	6HS8	310	6L5G	466
6FW5	266	6HZ6	312	6L6G	466
6FW8	464	6HZ8	314	6L6GB	466
6FY5/EC97	267	6J5	464	6L6	353
6FY7	267	6J5GT	464	6L6GC	353
6G6G	464	6J6	464	6L7	466
6G11	464	6J6A	314	6L7G	466
6GB5	268	6J7	464	6LB8	355
6GC5	269	6J7G	464	6LC8	356
6GES	270	6J7GT	464	6LE8	358
6GF5	271	6J8G	466	6LF8	358
6GF7	272	6J10	315	6LM8	360
6GF7A	272	6J11	316	6LN8	362
6GH8	464	6JB6	317	6M11	363
6GH8A	273	6JB6A	317	6MD8	363
6GJ5	464	6JC6	318	6N6G	466
6GJ5A	274	6JC8	320	6N7	466
6GJ7	275	6JD6	320	6N7GT	466
6GJ8	464	6JE6	466	6P5GT	466
6GK5	276	6JE6A	321	6P7G	466
6GK6	277	6JE8	323	6Q7	466
6GL7	279	6JG6	466	6Q7G	466
6GM5	279	6JG6A	324	6Q7GT	466
6GM6	280	6JH6	326	6Q11	466
6GN8	281	6JH8	327	6R7	466
6GT5	282	6JK8	327	6R7G	466
6GT5A	282	6JM6	328	6R7GT	466
6GU5	283	6JN6	329	6S4	466
6GU7	284	6JN8	329	6S4A	364
6GV5	285	6JS6	330	6S7	466
6GV8	286	6JT6	331	6S7G	466
6GW6	286	6JT6A	331	6S8GT	466
6GW8/ECL86	288	6JT8	333	6SA7	365
6GX6	288	6JU8	333	6SA7GT	466
6GX7	290	6JU8A	333	6SB7Y	466
6GY5	291	6JV8	334	6SC7	466
6GY6	292	6JZ8	335	6SF5	466
6GY8	464	6K5GT	466	6SF5GT	466
6GZ5	293	6K6GT	336	6SF7	468
6H6	294	6K7	466	6SG7	468
6H6GT	464	6K7G	466	6SH7	468
6HA5	295	6K7GT	466	6SJ7	366
6HB5	295	6K8	466	6SJ7GT	468

6SK7	468	7E7	470	10GF7A	272
6SK7GT	468	7EY6	470	10GN8	281
6SL7GT	367	7F7	470	10HF8	300
6SN7GT	468	7F8	470	10JA8	384
6SN7GTA	468	7G7	470	10JY8	385
6SN7GTB	368	7H7	470	10KR8	346
6SQ7	369	7HG8	302	10KU8	348
6SQ7GT	468	7J7	470	11	472
6SR7	468	7K7	470	11AR11	129
6SS7	468	7L7	470	11CY7	208
6ST7	468	7N7	470	11JE8	323
6SZ7	468	7Q7	470	11KV8	349
6T4	468	7R7	470	11LQ8	385
6T7G	468	7S7	470	12	472
6T8	468	7V7	470	12A5	472
6T8A	370	7W7	470	12A7	472
6T9	371	7X7	470	12A8GT	472
6T10	372	7Y4	470	12AB5	387
6U5	468	7Z4	470	12AC6	472
6U7G	468	8AU8	136	12AD6	472
6U8	468	8AW8A	139	12AE6	472
6U8A	372	8B10	145	12AE6A	472
6U10	373	8BA8A	149	12AE7	472
6V3A	374	8BH8	159	12AF3	115
6V6GT	468	8BN8	169	12AF6	472
6V6	375	8BQ5	170	12AH7GT	472
6V6GTA	375	8CG7	383	12AJ6	472
6V7G	468	8CM7	196	12AL5	120
6W4GT	376	8CN7	198	12AL8	472
6W6GT	377	8CS7	202	12AL11	121
6W7G	468	8CW5	206	12AQ5	126
6X4	379	8CX8	207	12AT6	132
6X5	468	8EB8	236	12AT7	389
6X5GT	380	8EM5	241	12AT7/ECC81	389
6X8	381	8ET7	247	12AU6	134
6Y5	468	8FQ7	470	12AU7	472
6Y6GA/6Y6G	382	8FQ7/8CG7	262	12AU7A	390
6Y7G	468	8GN8	281	12AU7A/ECC82	390
6Z5	468	8JV8	334	12AV5GA	137
6Z7G	468	8KA8	338	12AV6	137
6ZY5G	468	8LC8	356	12AV7	472
7A4	468	9A8	383	12AW6	391
7A5	468	9A8/PCF80	383	12AX3	141
7A6	468	9AU7	390	12AX4GT	472
7A7	470	9BR7	470	12AX4GTA	472
7A8	470	9CL8	472	12AX4GTB	141
7AD7	470	9EA8	235	12AX7	472
7AF7	470	9GV8	286	12AX7A	391
7AG7	470	9KZ8	352	12AX7A/ECC83	391
7AH7	470	9U8A	372	12AY3	143
7AU7	390	10	472	12AY3A	143
7B4	470	10AL11	121	12AY7	392
7B5	470	10C8	472	12AZ7	472
7B6	470	10CW5	206	12AZ7A	393
7B7	470	10DE7	216	12B4A	393
7B8	470	10DR7	223	12B8GT	472
7CS	470	10DX8	231	12BA6	146
7C6	470	10EG7	384	12BA7	474
7C7	470	10EM7	243	12BD6	474
7E6	470	10GF7	272	12BE3	154

12BE6	154	12FQ8	400	13CW4	204
12BF6	474	12FR8	400	13DE7	216
12BH7	474	12FV7	476	13DR7	223
12BH7A	394	12FX5	401	13EM7	243
12BK5	474	12FX8	476	13FD7	256
12BL6	474	12FX8A	402	13FM7	260
12BQ6GTB/12CU6	171	12GA6	476	13GB5	268
12BR7	474	12GC6	476	13GF7	272
12BS3	174	12GE5	270	13GF7A	272
12BS3A	174	12GJ5	476	13J10	315
12BT3	396	12GJ5A	274	14A4	478
12BV7	474	12GN7	403	14A5	478
12BW4	474	12GN7A	403	14A7	478
12BY7	474	12GT5	282	14AF7	478
12BY7A	396	12GT5A	282	14B6	478
12BZ6	180	12GW6	403	14B8	478
12BZ7	398	12GW6/12DQ6B	286	14C5	478
12C5	398	12H6	294	14C7	478
12C8	474	12HG7	403	14E6	478
12CA5	186	12J5GT	476	14E7	478
12CN5	474	12J7GT	476	14F7	478
12CR6	200	12J8	476	14F8	478
12CT8	474	12JB6	317	14GT8	404
12CU5/12C5	203	12JB6A	317	14H7	478
12CU6	398	12JN6	329	14J7	478
12CX6	474	12JN8	329	14JG8	405
12D4	398	12JT6	331	14N7	478
12DB5	211	12JT6A	331	14Q7	478
12DE8	474	12K5	476	14R7	478
12DK6	218	12K7GT	476	15	478
12DK7	474	12K8	476	15AF11	117
12DL8	474	12KL8	476	15BD11	153
12DM4	474	12L6GT	476	15CW5	206
12DM4A	219	12Q7GT	476	15CW5/PL84	206
12DO6A	474	12R5	476	15FM7	260
12DQ6B	222	12S8GT	478	15FY7	267
12DQ7	474	12SA7	365	15HB6	296
12DS7	474	12SA7GT	478	15KY8	350
12DS7A	474	12SC7	478	15KY8A	350
12DT5	227	12SF5	478	16AQ3	406
12DT8	229	12SF5GT	478	16AQ3/XY88	406
12DU7	474	12SF7	478	16GK6	277
12DV8	474	12SG7	478	17AX3	141
12DW7	474	12SH7	478	17AX4GT	478
12DY8	474	12SJ7	366	17AX4GTA	141
12DZ6	399	12SJ7GT	478	17AY3	143
12EA6	474	12SK7	478	17AY3A	143
12EC8	476	12SK7GT	478	17BE3	154
12ED5	476	12SL7GT	367	17BF11	156
12EG6	476	12SN7GT	478	17BH3	157
12EH5	238	12SN7GTA	368	17BH3A	157
12EK6	476	12SQ7	369	17BQ6GTB	171
12EL6	476	12SQ7GT	478	17BS3	173
12EM6	476	12SR7	478	17BS3A	173
12EN6	476	12SR7GT	478	17C5	430
12EQ7	244	12U7	478	17C9	184
12F5GT	476	12V6GT	375	17CU5	203
12F8	476	12W6GT	377	17D4	211
12FK6	476	12X4	379	17DE4	214
12FM6	476	12Z3	478	17DM4	480



17DM4A	219	25A6GT	480	36AM3B	428
17DQ6A	480	25A7GT	480	37	482
17DQ6B	222	25AC5GT	480	38	482
17EW8	406	25AV5GA	137	38HE7	429
17GE5	270	25AX4GT	141	39/44	482
17GJ5	480	25B5	480	40	484
17GJ5A	274	25B6G	480	41	484
17GT5	282	25B8GT	480	42	484
17GT5A	282	25BK5	480	43	484
17GV5	285	25BQ6GT	480	45	484
17GW6	286	25BQ6GTB/25CU6	171	45Z3	484
17H3	480	25C5	430	45Z5GT	484
17JB6	317	25C6G	480	46	484
17JB6A	317	25CA5	186	47	484
17JG6	480	25CD6GA	480	48	484
17JG6A	324	25CD6GB	190	49	484
17JM6	328	25CU6	415	50	484
17JN6	329	25DN6	415	50A5	484
17JT6	331	25EC6	480	50B5	430
17JT6A	331	25EH5	238	50C5	430
17JZ8	407	25F5A	416	50C6G	484
17LD8	480	25L6	480	50DC4	432
18A5	480	25L6GT	480	50EH5	238
18FW6	480	25N6G	480	50FE5	484
18FW6A	408	25W5GT	482	50FK5	484
18FX6	480	25Y5	484	50HC6	433
18FX6A	408	25Z5	482	50HK6	434
18FY6	480	25Z6	482	50L6GT	434
18FY6A	409	25Z6GT	482	50X6	484
18GD6A	409	26	482	50Y6GT	484
19	480	27	482	50Y7GT	484
19AU4	410	27GB5/PL500	268	50Z7G	484
19AU4GTA	480	30	482	53	484
19BG6G	480	31	482	60FX5	401
19BG6GA	480	32	482	70L7GT	484
19CL8A	195	32ET5	482	75	484
19EA8	235	32ET5A	418	78	484
19HR6	308	32L7GT	482	80	484
19HS6	309	33	482	84/6Z4	484
19HV8	410	33GT7	418	117L7/M7GT	484
19J6	480	33GY7	419	117N7GT	484
19JN8	329	33JV6	421	117P7GT	484
19T8	480	34	482	117Z3	484
19X8	381	34GD5	482	117Z4GT	486
20	480	34GD5A	421	117Z6GT	486
20EQ7	480	35	482	5879	435
20EZ7	411	35A5	482	5881	437
21EX6	480	35B5	482	6973	437
21GY5	291	35C5	423	7025	439
21HB5	295	35DZ8	482	7027	486
21HJ5	303	35EH5	424	7027A	440
22	480	35GL6	482	7189	442
22BH3	157	35L6GT	425	7199	443
22BH3A	157	35W4	426	7247	486
22BW3	412	35Y4	482	7355	445
22DE4	214	35Z3	482	7408	445
22JF6	413	35Z4GT	482	7543	446
22JG6	480	35Z5GT	427	7591	486
22JG6A	324	36	482	7591A	446
22JU6	414	36AM3	482	7695	486
24A	480	36AM3A	482	7868	447
25A6	480			EM84/6FG6	486

## INDEX

	<i>Page</i>		<i>Page</i>
Absolute Maximum System of Ratings	79	Calculation of:	
AC/DC Superhetrodyne Receiver	522	amplification factor	13
Admittance, Input	18	cathode (self-bias) resistor	70
All-Purpose Power Supply	560	cathode load resistor	34
AM Detection	48	control-grid-plate transconductance	14
AM/FM Receiver	524	filament resistor power dissipation	68
Amplification	15	filament (or heater) resistor value	68
Amplification Factor ( $\mu$ )	13	harmonic distortion	20, 22
Amplifier:		heater warm-up time	79
audio control unit, circuit	546	load resistance	20, 26
audio-frequency	15	operating conditions from	
audio mixer, circuit	538	conversion nomograph	23
cathode-drive	29	peak inverse plate voltage	82
cathode-follower	29, 32	plate efficiency	14
class A	15, 18	plate resistance	13
class AB	15, 24	power output	20, 26
class AB <sub>1</sub>	25	power sensitivity	14
class AB <sub>2</sub>	27	screen-grid voltage dropping resistor	81
class B	15, 28	transconductance	14, 33
class C	15	voltage amplification (gain)	16, 33, 34
high-fidelity	28	Capacitor-Input Filter	75
intermediate-frequency	532	Cathode:	
limiter	39, 49	bias	70
luminance	41	bypassing	70
parallel	19	connection	70
phase-inverter	36	current	68
preamplifier, circuits	542, 543	directly heated	3
push-pull	19, 21	drive	29
radio-frequency	15, 39	follower	29, 32
remote-cutoff	18, 59	indirectly heated	4
resistance-coupled	16, 31	ionic-heated	6
sync	44	resistor	70
television	39	types	3
tone-control	36	Cathode-Ray Oscilloscope	558
tone-control, circuit	545	Characteristic Curves, Interpretation of	83
video	43	Characteristics:	
voltage	15	amplification factor	13
volume-expander	35	control-grid-plate transconductance	14
Amplitude Modulation (AM)	48	conversion transconductance	14
Anode	5	dynamic	13
Application Guide for RCA		plate resistance	13
Receiving Tubes	85	static	13
Arc-Back Limit	82	Charts and Tables:	
Audio Control Unit with Volume and		grid-No.2 input rating chart	80
Tone Controls	546	picture tube characteristics chart	494
Audio Mixer	538	outline drawings	513
Audio Signal Generator	554	resistance-coupled amplifier	504
Automatic Frequency Control (AFC)	65	types for replacement use	450
Automatic Gain Control (AGC)	55	Choke-Input Filter	75
Automatic Volume Control (AVC)	55	Chrominance Channel	44
Bass and Treble Tone-Control		Circuit Diagram of:	
Amplifier Stage	545	ac/dc superhetrodyne receiver	522
Beam Power Tubes	9	all-purpose power supply	560
Bias:		AM/FM receiver	524
battery	70	audio-control unit	546
cathode (self)	70, 71	audio signal generator	554
diode	49	bass and treble tone-control	
grid-resistor	50, 65	amplifier stage	545
Burst	54	cathode-ray oscilloscope	558
Bypassing	70	citizens-band transceiver	526
		code practice oscillator	523
		electronic volt-ohm meter	556

	Page		Page
FM stereo multiplex adapter	529	Electronic Volt-Ohm Meter	556
FM tuner	530	Electrons, Electrodes, and Electron Tubes	3
high-fidelity, 15-w audio amplifier	534	Electron Tube Application	15
high-fidelity, 30-w audio amplifier	535	Electron Tube Characteristics	13
high-fidelity, 50-w audio amplifier	536	Electron Tube Installation	67
intercommunication set	533	Electron Tube Testing	500
low-distortion preamplifier	543	Electron-Ray Tubes	58
microphone and phonograph amplifier	540	Emission:	
phonograph amplifier	541	current	5
preamplifier for 10-m, 30-Mc/s amateur receiver	528	secondary	8, 9
preamplifier for ceramic phonograph-pickup	543	test	501
preamplifier for magnetic phonograph-pickup	542	Feedback, Inverse	30
three-stage if amplifier/limiter and ratio detector	532	Filament (also see Heater and Cathode):	
two-channel audio mixer	538	operation	3, 67
two-channel, 1-w stereo amplifier	539	resistor	68
two-stage input amplifier	544	series operation	68
Citizens-Band Transceiver	526	shunt resistor	69
Code Practice Oscillator	523	supply voltage	67
Color Demodulation	53	Filter:	
Color Picture Tubes	13	capacitor-input	74
Color Television	44	choke-input	74
Contact Potential	72	corrective	34
Conversion Nomograph, Use of	23	radio-frequency	74
Conversion Transconductance	14	smoothing	74
Corrective Filter	34	FM Detection	48
Cross-Modulation	18	FM Stereo Multiplex Adapter	529
Current:		FM Tuner	530
cathode	68	Formulas (see Calculation)	
dc output	81	Frame Grid	7
grid	24	Frequency Conversion	63
peak plate	82	Frequency Modulation (FM)	45, 48
plate	5	Full-Wave Diode Detection	46
Curves, Interpretation of Characteristic	83	Full-Wave Rectifier	5, 46
Cutoff	18	Fuses, Use of	70
Dark Heater	4	Gain (Voltage Amplification)	16
Deflection Circuits:		Generic Tube Types	4
horizontal output	62	Grid:	
vertical output	61	anode	64
Degeneration (See Inverse Feedback)	30	bias	69
Delayed Automatic Volume Control (DAVC)	51	bias detection	50
Demodulation	48, 53	control	6, 7
Design-Center System of Ratings	79	current	24
Design-Maximum System of Ratings	79	resistor	71
Detection:		resistor and capacitor detection	50
diode	48	screen	7
discriminator	51	suppressor	8
full-wave diode	46	voltage supply	69
grid bias	50	Grid-Plate Capacitance	7
grid resistor and capacitor	50	Grid-Plate Transconductance	14
ratio detector	52	Half-Wave Rectifier	5, 46
synchronous	54	Harmonic Distortion	20, 22, 27
Diode:		Heater:	
biasing	48	cathode	4
considerations	5	cathode bias	70
detection	48	cathode connection	70
load resistor	43	resistor	69
Discriminator	51	series operation	68
Dress of Circuit Leads	74	shunt resistor	68
Driver	27	supply voltage	67
Dynamic Characteristics	13	warm-up time	79
Electron:		Hexode Mixer	64
considerations	3	High-Fidelity Amplifiers	28, 76
secondary	8, 9	High-Fidelity, 15-w Audio Amplifier	534
		High-Fidelity, 30-w Audio Amplifier	535
		High-Fidelity, 50-w Audio Amplifier	536

	Page		Page
High-Voltage Regulation	62	Pentagrid Mixer	64
Horizontal Output Circuits	62	Pentode Considerations	8
Hum and Noise Characteristics	83	Phase Inverter	36
<b>IF Amplifier/Limiter and Ratio Detector</b>	<b>532</b>	Phonograph Amplifier	541
Impedance, Input	17	Phonograph and Tape Preamplifiers	38
Injection Voltage	42	<b>Picture Tube:</b>	
Input Capacitance	83	characteristics chart	494
Instantaneous Peak Voltage	82	corona considerations	78
Intercommunication Set	533	deflection	10
Interelectrode Capacitances	7, 83	dust considerations	78
Intermediate Frequency, Production of	62	essential elements	10
Interpretation of Tube Data	79	handling precautions	78
Inverse Feedback:		high-voltage considerations	77
constant-current type	31	humidity considerations	78
constant-voltage type	30	safety considerations	78
<b>Key: Basing Diagrams, Inside Back Cover</b>		screen	10
Kinescopes	10	structure	10
<b>Limiters</b>	<b>39</b>	x-ray radiation precautions	78
<b>Load:</b>		<b>Plate:</b>	
resistance	21	current	5
resistance line	19	dissipation	80
Local Oscillator	42	efficiency	14
Low-Distortion preamplifier	543	load	21
Luminance Amplifier	44	resistance	13
<b>Maximum Ratings</b>	<b>79</b>	voltage supply	69
<b>Mercury-Vapor Rectifier:</b>		Plate-Cathode Capacitance	7, 83
considerations	6	<b>Power Output:</b>	
interference from	75	calculations	19
Mho-micromho	14	test	500
Microphone and Phonograph Amplifier	540	<b>Power Sensitivity</b>	14
<b>Mixer:</b>		<b>Power Supply</b>	560
audio	538	Preamplifier for Amateur Receiver	528
hexode	64	Preamplifier for Ceramic Phonograph	
pentagrid	64	Pickup	543
vhf tuner	42	Preamplifier for Magnetic Phonograph	
Modulated Wave	48	Pickup	542
Modulation	48	<b>Preamplifiers, Phonograph and Tape</b>	<b>38</b>
Modulation-Distortion	69	<b>Push-Pull Operation</b>	<b>19</b>
Multi-Electrode and Multi-Unit Tubes	9	<b>Radio-Frequency:</b>	
Multiplex Adapter for FM Stereo	529	amplifier	15, 39
Multivibrator	59	filter	74
<b>Noise</b>	<b>40, 83</b>	<b>Ratings:</b>	
<b>Noise Figure</b>	<b>41</b>	absolute-maximum system	79
Novar	10	design-center system	79
Novar Tube, Parts of	2	design-maximum system	79
Nuvistor	10	Ratio Detector	49, 532
<b>Operation, Typical Values</b>	<b>83</b>	<b>Rectifiers:</b>	
<b>Oscillator:</b>		full-wave	5, 46
considerations	59	half-wave	5, 46
local	42	ionic-heated cathode	6
multivibrator	59	parallel operation of	46
relaxation	59	plate-characteristics curves	83
synchronuide	60	voltage doubler	47
Oscilloscope	558	Relaxation Oscillator	59
Output Capacitance	83	Remote-Cutoff Tubes	18
<b>Output Circuits:</b>		<b>Resistance-Coupled Amplifiers</b>	<b>17, 504</b>
horizontal	62	<b>Resistance Coupling</b>	<b>36</b>
vertical	61	<b>Resistor:</b>	
Output-Coupling Devices	76	cathode (self-biasing)	71
<b>Parallel Operation</b>	<b>19, 46</b>	center tap	70
<b>Peak Inverse Plate Voltage</b>	<b>82</b>	filament	70
<b>Peak Plate Current</b>	<b>81</b>	filter	74
<b>Pentagrid Converter</b>	<b>9</b>	grid	16
		plate load	21
		screen-grid	72, 80

	<i>Page</i>		<i>Page</i>
Saturation Current .....	5	grid-plate .....	14
Screen Grid (Grid No.2):		test .....	501
considerations .....	7	Triode Considerations .....	6
input .....	80	Tube:	
voltage supply .....	72	outlines .....	513
Secondary Electrons .....	8, 9	ratings, interpretation of .....	79
Secondary Emission .....	8	tester requirements .....	502
Self Bias (cathode bias) .....	70	Tube Types, Technical Data .....	93
Shielding .....	73	Tuner, FM .....	530
Short-Circuit Test .....	500	Tuners, Television .....	39
Signal Generator .....	554	Tuning Indicators .....	58
Signal-to-Noise Ratio .....	40	Twin diode—triode .....	49
Space Charge .....	5, 9	Two-Channel Audio Mixer .....	538
Static Characteristics .....	13	Two-Channel Stereophonic Amplifier .....	539
Stereo Circuits .....	529, 539	Two-Stage Input Amplifier, Cathode- Follower (Low-Impedance) Output .....	544
Superheterodyne Receiver:		Typical Operation Values, Interpretation of .....	83
ac/dc .....	522	Vertical Output Circuits .....	61
portable .....	521	Video Amplifiers .....	43
Suppressor Grid (Grid No.3) .....	8	Voltage:	
Sync Circuits .....	44	amplification, class A .....	15
Synchroguide .....	60	double rectifier .....	46
Synchronous Detection .....	54	peak heater-cathode .....	81
Technical Data for Tube Types .....	94	peak inverse plate .....	82
Television Picture Tubes .....	10	supply .....	67
Television RF Amplifiers .....	39	Voltage Doubler .....	47
Television Sync Circuits .....	44	Volt-Ohm Meter .....	556
Testing Electron Tubes .....	500	Volume Control:	
Tetrode Considerations .....	7	automatic (AVC) .....	55
Three-Stage IF Amplifier/Limiter and Ratio Detector .....	532	by grid-voltage variation .....	70
Tone-Control Amplifier Stage .....	545	by screen-grid-voltage variation .....	72
Tone Control .....	36	delayed automatic (DAVC) .....	56
Transceiver, Citizens-Band .....	526	Volume Compressor and Expander .....	32
Transconductance:		Zero-Bias Operation .....	70
conversion .....	14		

# RCA Technical Publications

## on Electron Tubes, Semiconductor Products, and Batteries

**C**OPIES of the publications listed below may be obtained from your RCA distributor or from Commercial Engineering, Radio Corporation of America, Harrison, N. J.

### Electron Tubes

● **RCA ELECTRON TUBE HANDBOOK**—HB-3 (7 $\frac{3}{8}$ " x 5 $\frac{5}{8}$ ")—Five 2 $\frac{1}{4}$ -inch-capacity binders. Contains over 5000 pages of looseleaf data and curves on RCA receiving tubes, transmitting tubes, cathode-ray tubes, picture tubes, photocells, phototubes, camera tubes, ignitrons, vacuum gas rectifiers, traveling-wave tubes, premium tubes, pencil tubes, and other miscellaneous types for special applications. Available on subscription basis. Price \$20.00\* including service for first year. Also available with RCA Semiconductor Products Handbook HB-10 at special combination price of \$25.00.\*

● **RADIOTRON<sup>®</sup> DESIGNER'S HANDBOOK**—4th Edition (8 $\frac{3}{4}$ " x 5 $\frac{1}{2}$ ")—1500 pages. Comprehensive reference covering the design of radio and audio circuits and equipment. Written for the design engineer, student, and experimenter. Contains 1000 illustrations, 2500 references, and cross-referenced index of 7000 entries. Edited by F. Langford-Smith. Price \$7.00.\*†

● **RCA PHOTOTUBE AND PHOTOCCELL MANUAL**—PT-60 (8 $\frac{1}{4}$ " x 5 $\frac{3}{8}$ ")—192 pages. Well-illustrated informative manual covering fundamentals and operating considerations for vacuum and gas phototubes, multiplier phototubes, and photocells. Also describes basic appli-

cations for these devices. Features easy-to-use selection chart for multiplier phototubes. Data and performance curves given for over 90 photo-sensitive devices. Price \$1.50.\*†

● **RCA TRANSMITTING TUBES**—TT-5 (8 $\frac{1}{4}$ " x 5 $\frac{5}{8}$ ")—320 pages. Gives data on over 180 power tubes having plate-input ratings up to 4 kw and on associated rectifier tubes. Provides basic information on generic types, parts and materials, installation and application, and interpretation of data. Contains circuit diagrams for transmitting and industrial applications. Features lie-flat binding. Price \$1.00.\*†

● **RCA INTERCHANGEABILITY DIRECTORY OF INDUSTRIAL-TYPE ELECTRON TUBES**—ID-1020-F (10 $\frac{7}{8}$ " x 8 $\frac{3}{8}$ ")—12 pages. Lists more than 2300 basic type designations for 20 classes of industrial tube types; shows the RCA Direct Replacement Type or the RCA Similar Type, when available. Price 15 cents.\*†

● **RCA INDUSTRIAL RECEIVING-TYPE TUBES**—RIT 104P (10 $\frac{7}{8}$ " x 8 $\frac{3}{8}$ ")—52 pages. Technical information on over 200 RCA "special red" tubes, premium tubes, nuvistors, computer tubes, pencil tubes, glow-discharge tubes, small thyratrons, low-microphonic amplifier tubes, mobile communications tubes, and other special types. Includes socket-connection diagrams. Price 40 cents.\*†

● **RCA RECEIVING TUBES AND PICTURE TUBES**—1275L (10 $\frac{7}{8}$ " x 8 $\frac{3}{8}$ ")—56 pages. New, enlarged, and up-to-date booklet contains classification chart, application guide, characteristics chart, and base and envelope connec-

tion diagrams on more than 1300 entertainment receiving tubes and picture tubes. Price 50 cents.\*†

● **RCA INTERCHANGEABILITY DIRECTORY OF FOREIGN vs. U.S.A. RECEIVING-TYPE ELECTRON TUBES—1CE-197D** (8 $\frac{3}{8}$ " x 10 $\frac{7}{8}$ ")—8 pages. Covers approximately 800 foreign tube types used principally in AM and FM radios, TV receivers, and audio amplifiers. Indicates U.S.A. direct replacement type or similar type if available. Price 10 cents.\*

● **RCA PHOTOCELLS—CSS-800** (10 $\frac{7}{8}$ " x 8 $\frac{3}{8}$ ")—36 pages. Contains a selection of photocell-circuit diagrams; technical data and characteristic curves of RCA photoconductive, photojunction, and photovoltaic cells; interchangeability information. Also contains representative circuits. Price 40 cents.\*†

● **RCA NUVISTOR TUBES FOR INDUSTRIAL AND MILITARY APPLICATIONS—1CE-280** (10 $\frac{7}{8}$ " x 8 $\frac{3}{8}$ ")—16 pages. Describes unique features of nuvistors and includes tabular data, dimensional outlines, curves, terminal diagrams, and socket information. Price 25 cents.\*†

● **RCA COMMAND TUBES—RIT-105**—36 pages. Detailed technical data for six "command" types including types 12AT7WA, 5G54, 5670, 5751, 5814A, and 6136. These types are interded for use in critical industrial, aircraft, and other equipment requiring exceptional stability and reliability under severe environmental conditions. Price 40 cents.\*

● **RCA NOVAR TUBES—1CE-311**—12 pages. Describes unique features of novar tube types and includes tabular data, dimensional outlines, curves, and terminal diagrams. Single copy free on request.

● **RCA PHOTOMULTIPLIER AND IMAGE TUBES—PIT-700** (10 $\frac{7}{8}$ " x 8 $\frac{3}{8}$ ")—36 pages. Includes concise data on RCA photomultiplier tubes, gas and vacuum photodiodes, sockets and shields for phototubes, and dimensional outlines for photo and image tubes. Price 60 cents.\*

● **PRODUCT GUIDE FOR RCA POWER TUBES—PWR-506A**—32 pages. Contains tabulated data on all RCA power tubes in order of type designation within each general class of service. Includes maximum ratings, temperature ratings, heater or filament requirements, outline drawings, and basing diagrams. Price 15 cents.\*

● **RCA INDUSTRIAL TUBES PRODUCT GUIDE—TPG-200** (10 $\frac{7}{8}$ " x 8 $\frac{3}{8}$ ")—28 pages. Covers all RCA industrial-tube product lines. Gives a brief description of each product line together with quick-selection data. Single copy free on request.

● **RCA POWER TUBES CLASSIFICATION CHARTS—PWR-504**—12 pages. Groups all power tube types by their rated classes of service and lists them in order of power capability. Price 15 cents.\*

● **RCA STORAGE TUBES AND CATHODE-RAY TUBES—STC-900A**—16 pages. Contains technical information on RCA storage tubes, special-purpose kinescopes and oscillograph-type cathode-ray tubes including display-storage tubes, computer-storage tubes, radechons, scan conversion tubes, flying-spot tubes, monitor, projection, transcriber, and view-finder kinescopes; as well as data on fluorescent screens. Price 25 cents.\*

● **RCA TRAVELING-WAVE TUBE CLASSIFICATION CHARTS—MWD-101A**—4 pages. Contains catalog-type data. Single copy free on request.

● **RCA PENCIL TUBE CLASSIFICATION CHARTS—MWD-102**—2 pages. Contains catalog-type data. Single copy free on request.

● **RCA SOLID-STATE DEVICE CLASSIFICATION CHARTS—MWD-104A**—2 pages. Contains catalog-type data for solid-state microwave devices. Single copy free on request.

● **RCA CAMERA TUBES—CAM-600**—16 pages. Contains classification charts, defining data and typical characteristic curves for RCA image orthicons and vidicons. Camera tubes recommended

for new equipment design are highlighted. Price 50 cents.\*

● **TECHNICAL BULLETINS**—Authorized information on RCA receiving tubes, transmitting tubes, and other tubes for communications and industry. Be sure to mention tube-type bulletin desired. Single-copy on any type free on request.

### Semiconductor Products

● **RCA SEMICONDUCTOR PRODUCTS HANDBOOK**—HB-10. Two binders, each 7 $\frac{3}{8}$ " L x 5 $\frac{5}{8}$ " W x 2 $\frac{1}{2}$ " D. Contains over 1000 pages of loose-leaf data and curves on RCA semiconductor devices such as transistors, silicon rectifiers, and semiconductor diodes. Available on a subscription basis. Price \$10.00\* including service for first year. Also available with RCA Electron Tube Handbook HB-3 at special combination price of \$25.00.\*

● **RCA TRANSISTOR MANUAL**—SC-11 (8 $\frac{3}{8}$ " x 5 $\frac{3}{8}$ ")—384 pages. Contains up-to-date definitive data on over 600 semiconductor devices including tunnel diodes, silicon controlled rectifiers, varactor diodes, conventional rectifiers, and many classes of transistors. Features easy-to-understand text chapters, as well as tabular data on RCA discontinued transistors. Contains over 40 practical circuits, complete with parts lists, highlighting semiconductor-device applications. Price \$1.50.\*†

● **RCA TUNNEL DIODE MANUAL**—TD-30 (8 $\frac{3}{8}$ " x 5 $\frac{3}{8}$ ")—160 pages. Describes the microwave and switching capabilities of tunnel diodes. Contains information on theory and characteristics, and on tunnel-diode applications in switching circuits and in microwave oscillator, converter, and amplifier circuits. Includes data for over 40 RCA germanium and gallium arsenide tunnel diodes and tunnel rectifiers. Price \$1.50.\*†

● **RCA SEMICONDUCTOR PRODUCTS GUIDE**—SPG201/IL1147B (10 $\frac{1}{8}$ " x 8 $\frac{3}{8}$ ")—20 pages. Contains classification chart, index, and ratings and characteristics on RCA's line of transistors,

silicon rectifiers, semiconductor diodes, and photocells. Single copy free on request.

● **RCA SILICON RECTIFIERS**—62S25—6 pages. Describes RCA's line of diffused-junction rectifiers. Includes maximum ratings and characteristics plus rectifier circuit chart which shows voltage and current relationships together with waveforms for single and polyphase rectifier circuits. Single copy free on request.

● **RCA SILICON RECTIFIER INTERCHANGEABILITY DIRECTORY**—1CE-229A—16 pages. Contains replacement information, ratings, characteristics, and physical dimensions for more than 400 silicon and selenium rectifiers. Price 25 cents.\*

● **RCA SILICON POWER RECTIFIERS**—62S10—8 pages. Contains technical data on RCA's line of diffused-junction silicon power rectifiers. Includes quick-selection guide for stud-type and high-voltage "stack" and "stick" type rectifiers. Single copy free on request.

● **RCA DIFFUSED-JUNCTION SILICON RECTIFIER STACKS AND BRIDGES**—SRS-300—10 pages. Contains technical data on RCA's diffused-junction silicon rectifier stacks and bridges. Characteristics of basic rectifier circuits are also given to assist in selection of proper RCA rectifier device. Price 20 cents.\*

● **RCA SMALL-SIGNAL SILICON N-P-N TRANSISTORS**—SST-210—8 pages. Contains technical data on 2N2102 family of silicon transistors including high-voltage types, very-high voltage types, linear-beta types, and general types. Also includes quick-reference guide. Price 20 cents.\*

### Batteries

● **RCA BATTERY MANUAL**—BDG-111 (10 $\frac{1}{8}$ " x 8 $\frac{3}{8}$ ")—64 pages. Contains information on dry cells and batteries [carbon zinc (Leclanché), mercury, and alkaline types]. Includes battery theory and applications, detailed electrical and mechanical characteristics, a classification chart, dimensional out-



lines, and terminal connections on each battery type. Price 50 cents.\*†

● **RCA BATTERIES**—BAT-134G (10 $\frac{7}{8}$ " x 8 $\frac{3}{8}$ "—32 pages. Technical data on 142 Leclanché, alkaline, and mercury-type dry batteries for radios, industrial applications, flashlights, lanterns, and for photoflash service. Price 35 cents.\*†

## Test and Measuring Equipment

● **INSTRUCTION BOOKLETS** — Illustrated instruction booklets are available for all RCA test instruments at the prices indicated below.

WA-44A (Audio Signal Generator) .....	\$0.50*	WR-99A (Marker Calibrator) ..	1.00*
WA-44C (Audio Signal Generator) .....	1.00*	WT-100A (Electron-Tube Micro Mho Meter) .....	1.75*
WO-33A (Super Portable Oscilloscope) .....	1.00*	WT-100A (Electron-Tube Micro Mho Meter, Ser. No. 1001 and over) .....	2.00*
WO-88A (5-in. Oscilloscope) ...	0.75*	WT-100A (Tube Chart ICE-163) .....	3.00*
WO-91A (5-in. Oscilloscope) ...	1.00*	WT-110A (Automatic Electron-Tube Tester) .....	0.75*
WO-91B (5-in. Oscilloscope) ...	1.00*	WT-110A (ICE-174 Card Punch Data) .....	0.25*
WR-36A (Dot-Bar Generator) .	0.50*	WT-110A (ICE-234 Card Punch Data) .....	1.00*
WR-46A (Video Dot/Crosshatch Generator) .....	1.00*	WT-115A (Color Picture Tube Tester) .....	0.50*
WR-49A (RF Signal Generator) .....	0.50*	WV-37A (Radio Battery Tester) .....	0.25*
WR-49B (RF Signal Generator) .....	1.00*	WV-37B (Radio Battery Tester) .....	0.25*
WR-50A (RF Signal Generator) .....	1.00*	WV-38A (Volt-Ohm-Milliammeter) .....	0.50*
WR-51A (Stereo FM Signal Simulator) .....	1.00*	WV-65A (VoltOhmyst†) .....	0.25*
WR-52A (Stereo FM Signal Simulator) .....	1.00*	WV-74A (High Sensitivity AC VTVM) .....	0.75*
WR-61B (Color-Bar Generator) .....	1.00*	WV-75A (VoltOhmyst†) .....	0.25*
WR-64A (Color Bar/Dot/Cross-hatch Generator) .....	1.00*	WV-76A (High Sensitivity AC VTVM) .....	0.75*
WR-64B (Color/Bar/Dot/Cross-hatch Generator) .....	1.00*	WV-77A (VoltOhmyst†) .....	0.25*
WR-67A (Test-Oscillator) .....	0.25*	WV-77B (VoltOhmyst†) .....	0.25*
WR-69A (Television/FM Sweep Generator) .....	1.00*	WV-77E (VoltOhmyst†) .....	1.00*
WR-70A (RF-IF-VF Marker Adder) .....	0.75*	WV-84C (Ultra-Sensitive DC Microammeter) .....	0.75*
WR-86A (UHF Sweep Generator) .....	0.50*	WV-95A (Master VoltOhmyst†) .....	0.25*
		WV-97A (Senior VoltOhmyst†) .....	0.75*
		WV-98A (Senior VoltOhmyst†) .....	1.00*
		WV-98B (Senior VoltOhmyst†) .....	1.00*
		WV-98C (Senior VoltOhmyst†) .....	0.50*
		195-A (VoltOhmyst†) .....	0.25*

\* Trade Mark Reg. U.S. Pat. Off.

\* Prices shown apply in U.S.A. and are subject to change without notice.

† Suggested price.

## Reading List

This list includes references of both elementary and advanced character. Obviously, the list is not inclusive, but it will guide the reader to other references.

- ALBERT, A. L. *Electrons and Electron Devices*. The Macmillan Co.
- BECK, A. H. W. *Thermionic Valves*. Cambridge University Press
- CHUTE, G. M. *Electronics in Industry*. McGraw-Hill Book Co., Inc.
- DOME, R. B. *Television Principles*. McGraw-Hill Book Co., Inc.
- DOW, W. G. *Fundamentals of Engineering Electronics*. John Wiley and Sons, Inc.
- EASTMAN, A. V. *Fundamentals of Vacuum Tubes*. McGraw-Hill Book Co., Inc.
- EDSON, W. A. *Vacuum Tube Oscillators*. John Wiley and Sons, Inc.
- FINK, D. G. *Television Engineering*. McGraw-Hill Book Co., Inc.
- GHIRARDI, A. A. *Radio and Television Receiver Circuitry and Operation*. Rinehart and Co., Inc.
- GRAY, T. S. *Applied Electronics*. John Wiley and Sons, Inc.
- GROB, B. *Basic Television*. McGraw-Hill Book Co., Inc.
- HENNEY, KEITH. *Radio Engineering Handbook*. McGraw-Hill Book Co., Inc.
- HOAG, J. B. *Basic Radio*. D. Van Nostrand Co., Inc.
- KOLLER, L. R. *Physics of Electron Tubes*. McGraw-Hill Book Co., Inc.
- MAEDEL, G. F. *Basic Mathematics for Television and Radio*. Prentice-Hall, Inc.
- MARCUS, A. *Elements of Radio*. Prentice-Hall, Inc.
- MARKUS AND ZELUFF. *Handbook of Industrial Electronic Circuits*. McGraw-Hill Book Co., Inc.
- MILLMAN AND SEELY. *Electronics*. McGraw-Hill Book Co., Inc.
- MOYER AND WOSTREL. *Radio Receiving and Television Tubes*. McGraw-Hill Book Co., Inc.
- PENDER, DELMAR, AND MCILWAIN. *Handbook for Electrical Engineers—Communications and Electronics*. John Wiley and Sons, Inc.
- PREISMAN, A. *Graphical Constructions for Vacuum Tube Circuits*. McGraw-Hill Book Co., Inc.
- HICKEY, H. V., and VILLINES, JR., W. M. *Elements of Electronics*. McGraw-Hill Book Co., Inc.
- RCA TECHNICAL BOOK SERIES. *Electron Tubes, Vol. I and Vol. II*. RCA Review.
- REICH, H. J. *Theory and Applications of Electron Tubes*. McGraw-Hill Book Co., Inc.
- RICHTER, WALTHER. *Fundamentals of Industrial Electronic Circuits*. McGraw-Hill Book Co., Inc.
- SEELY, S. *Electron Tube Circuits*. McGraw-Hill Book Co., Inc.
- SPANGENBERG, K. R. *Vacuum Tubes*. McGraw-Hill Book Co., Inc.
- STURLEY, K. R. *Radio Receiver Design*. Chapman and Hall, Ltd.
- TERMAN, F. E. *Fundamentals of Radio*. McGraw-Hill Book Co., Inc.
- TERMAN, F. E. *Radio Engineers Handbook*. McGraw-Hill Book Co., Inc.
- The Radio Amateurs Handbook*. American Radio Relay League.
- ZWORYKIN AND MORTON. *Television: The Electronics of Image Transmission*. John Wiley and Sons, Inc.

## KEY: BASING DIAGRAMS (Bottom Views)

●	Gas-Type Tube	F—	Filament (negative only)	LC	Do Not Use, Except As Specified in Data
BC	Base Sleeve	F <sub>x</sub>	Filament Tap	NC	No Internal Connection— May Be Used As Tie Point
BS	Base Shell	G	Grid	P	Plate (Anode)
C	External Con- ductive Coating	H	Heater	RC	Ray-Control Electrode
CL	Collector	H <sub>L</sub>	Heater Tap for Panel Lamp	S	Shell
DJ	Deflecting Elec- trode	H <sub>x</sub>	Heater Tap	TA	Target
ES	External Shield	IC	Do Not Use		
F	Filament	IS	Internal Shield		
F+	Filament (positive only)	K	Cathode		

Subscripts for multi-unit types: **B**, beam unit; **D**, diode unit; **HP**, heptode unit; **HX**, hexode unit; **P**, pentode unit; **T**, triode unit; **TR**, tetrode unit.

Many tube types are available in addition to the home-entertainment types described in this manual. For industrial and specialized applications, other small receiving-type tubes are available, such as nuvistor tubes, "premium" tubes, thyratrons, cold-cathode (glow-discharge) tubes, computer tubes, tubes for mobile communications applications, and Special Red tubes. Other lines of RCA electron devices include:

### POWER TUBES

*Transmitting and  
Industrial Types*

### TELEVISION CAMERA TUBES

*Image Orthicons,  
Vidicons, and  
Monoscopes*

### PHOTOTUBES

*Single-Unit, Twin-Unit,  
and Multiplier Types*

### PHOTOCELLS

*Photoconductive and  
Photojunction Types*

### THYRATRONS and IGNITRONS

### MICROWAVE TUBES

*Magnetrons, Traveling-Wave  
Tubes, Pencil Tubes*

### CATHODE-RAY TUBES

*Special-Purpose Kinescopes,  
Storage Tubes, and  
Oscillograph Types*

### SPECIAL TYPES

*Vacuum Gauge Tubes,  
Image Converters*

### SEMICONDUCTOR DEVICES

*Germanium and Silicon  
Transistors, Silicon Rectifiers,  
Tunnel Diodes,  
Silicon Controlled Rectifiers,  
Memory Devices*

**RADIO CORPORATION OF AMERICA**

ELECTRONIC COMPONENTS AND DEVICES

HARRISON, N. J.



# RCA RECEIVING TUBE MANUAL