

PHILIPS

APPLICATION BOOK



ELECTRONIC COMPONENTS
AND MATERIALS

DESIGNING MICROWAVE CATERING EQUIPMENT

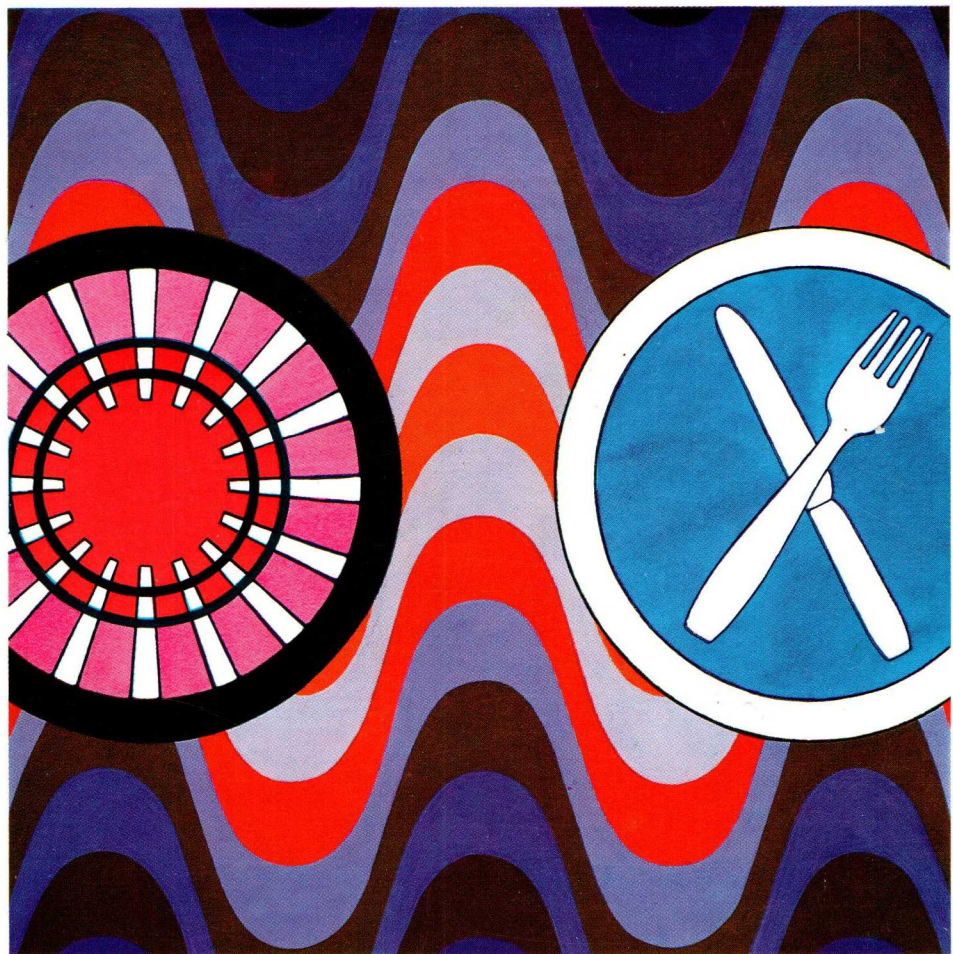

The first part of the document discusses the importance of maintaining accurate records of all transactions. It emphasizes that every entry, no matter how small, should be recorded to ensure the integrity of the financial statements. This includes not only sales and purchases but also expenses and income. The document also highlights the need for regular reconciliation of accounts to identify any discrepancies early on.

In the second part, the author provides a detailed breakdown of the accounting cycle. It starts with identifying the accounting period and ends with the preparation of financial statements. Each step is explained in detail, with examples provided to illustrate the process. The document also discusses the importance of using the correct accounting methods and the impact of different methods on the financial results.

The third part of the document focuses on the classification of assets and liabilities. It explains how to distinguish between current and long-term assets and liabilities, and how to value them appropriately. The document also discusses the importance of disclosing the nature and extent of these assets and liabilities in the financial statements.

Finally, the document concludes with a summary of the key points discussed. It reiterates the importance of accuracy, transparency, and regular reconciliation in the accounting process. It also provides some final thoughts on the role of accounting in the overall financial management of a business.

Designing Microwave Catering Equipment

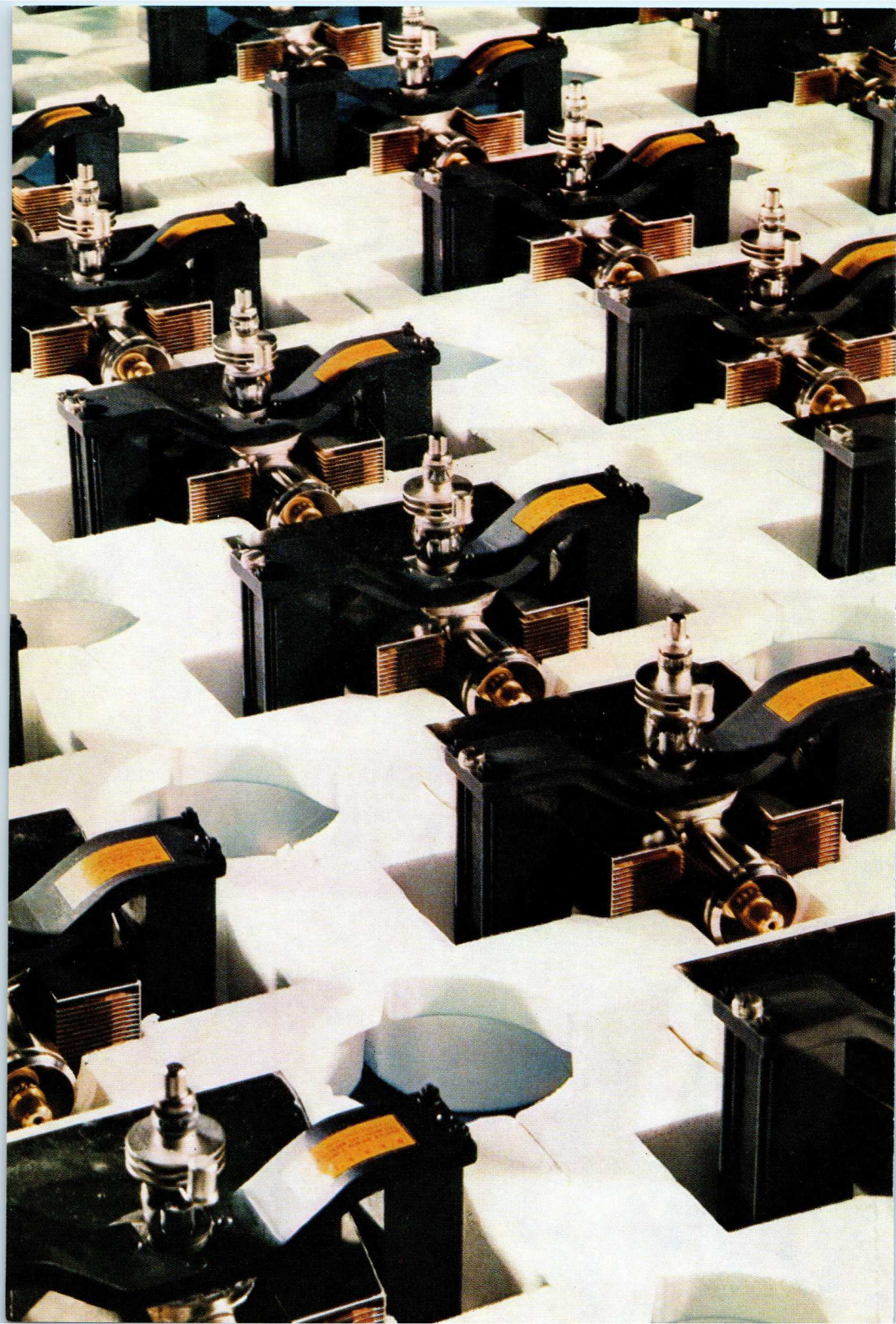

Designing
Microwave Catering Equipment

M. D. Hull and L. J. Thompson

PUBLICATIONS DEPARTMENT
ELECTRONIC COMPONENTS AND MATERIALS DIVISION

© *N.V. Philips' Gloeilampenfabrieken*

EINDHOVEN - The Netherlands

May 1971

*The publication of this document does not
imply a licence under any patent*

List of Contents

1 Microwave Catering	1
1.1 The Process of Heating	1
1.2 Practical Considerations	3
1.3 Summary of the Benefits of Microwave Catering	8
2 The Magnetron	9
2.1 Principles of Operation	9
2.2 Parasitic Oscillations	14
2.3 Cathodes	15
2.4 Output Coupling	15
2.5 Power Supplies	16
2.6 Cooling	16
2.7 R.F. Interference	16
3 Operating Characteristics	17
3.1 V.S.W.R.	17
3.2 Characteristics	20
3.2.1 Performance Chart	20
3.2.2 The Load Diagram	21
3.3 The Working Point	22
3.4 The Load	26
4 The Microwave Oven	29
4.1 Excitation Modes	29
4.2 The Cavity	34
4.3 Microwave Leakage	34
4.4 Field Stirrers	36
4.5 Coupling	38
4.6 Conveyor Belt Ovens	38
5 Power Supplies	43
5.1 Anode Current Stabilization	43
5.1.1 Resistive Control	43
5.1.2 Saturable Reactor Control	44
5.1.3 Thyristor Phase Control	44
5.1.4 Thyristor Chopper Circuits	44
5.1.5 Variable Impedance Circuits	45
5.2 Saturable Core Reactors	45
5.3 Resonant Circuits	46
5.4 Heater Supplies	48
5.5 Practical Power Supply Units	48
5.5.1 Power Supply Unit for the 1 kW Magnetron YJ1280	48
5.5.2 Power Supply Unit for the 2 kW Magnetron YJ1162	53

6 Cooling and Screening	57
6.1 Air Cooling	57
6.2 Water-cooled Anode Block	58
6.3 R.F. Interference	61
7 Measurements on Prototype	63
7.1 Cold Measurements	63
7.2 Hot Measurements	64
7.2.1 Energy Distribution	64
7.2.2 Heating Efficiency	65
7.2.3 Stray Magnetic Fields	66
7.3 Power Supply Measurements	66
7.4 Seal Temperatures	68
7.5 Stray Leakage	70
7.6 Production Testing	70
7.7 Brief Check-List	71
7.7.1 Useful Output Power	71
7.7.2 Load Impedance and Stability	73
7.8 Oscilloscope Method of Checking for Moding	73

Foreword

It is about ten years since microwaves were first used commercially for cooking and heating food. As with all new ideas, the advantages of the process were at first exaggerated; today one is more realistic and realizes that microwaves will not cook everything instantly. Microwave appliances, however, meet a number of catering requirements; not only where time and labour are prime considerations, but also where quality is important. Microwave ovens form a profitable part of many catering activities.

Except in some large food processing plants, microwave ovens have been generally used in addition to other equipment. But many caterers now see a great future for microwave appliances as part of an integrated catering process, with food preparation and cooking handled as a factory activity, much as frozen foods are at present, because

- microwave heating is fast, and can heat pre-cooked meals to a quality not possible hitherto;
- the phases of preparation and serving food are completely separate and cost control can be of a high standard resulting in greater efficiency.

From a customer's viewpoint, all this means better quality food, cheaper and quicker.

This book describes in simple terms the principles of microwave food ovens and particularly, the continuous wave magnetron which generates the energy. A Chapter is also devoted to power supplies.

Whilst this book is not intended as a definitive work on the subject of microwave heating, it should prove of interest to manufacturers of microwave catering equipment as a survey of the basic principles involved in design. In view of the constantly changing state-of-the-art, it is recommended that the component manufacturer is consulted before design work commences.

M.D.H.

L.J.T.

the 1990s, the number of people in the UK who are aged 65 and over has increased from 10.5 million to 13.5 million, and the number of people aged 75 and over has increased from 4.5 million to 6.5 million (Office for National Statistics 2000).

There is a growing awareness of the need to address the needs of older people, and the UK Government has set out a strategy for the 21st century in the White Paper on *Ageing Better: Our Future* (Department of Health 2000). This strategy is based on the following principles:

- (i) older people should be able to live independently in their own homes;
- (ii) older people should be able to live in their own communities;
- (iii) older people should be able to live in good health and be able to take part in the activities of their communities;
- (iv) older people should be able to live in dignity and respect.

There is a growing awareness of the need to address the needs of older people, and the UK Government has set out a strategy for the 21st century in the White Paper on *Ageing Better: Our Future* (Department of Health 2000).

This strategy is based on the following principles: (i) older people should be able to live independently in their own homes; (ii) older people should be able to live in their own communities; (iii) older people should be able to live in good health and be able to take part in the activities of their communities; (iv) older people should be able to live in dignity and respect.

The White Paper also sets out a number of key objectives for the 21st century, including: (i) to ensure that older people are able to live independently in their own homes; (ii) to ensure that older people are able to live in their own communities; (iii) to ensure that older people are able to live in good health and be able to take part in the activities of their communities; (iv) to ensure that older people are able to live in dignity and respect.

The White Paper also sets out a number of key objectives for the 21st century, including: (i) to ensure that older people are able to live independently in their own homes; (ii) to ensure that older people are able to live in their own communities; (iii) to ensure that older people are able to live in good health and be able to take part in the activities of their communities; (iv) to ensure that older people are able to live in dignity and respect.

The White Paper also sets out a number of key objectives for the 21st century, including: (i) to ensure that older people are able to live independently in their own homes; (ii) to ensure that older people are able to live in their own communities; (iii) to ensure that older people are able to live in good health and be able to take part in the activities of their communities; (iv) to ensure that older people are able to live in dignity and respect.

The White Paper also sets out a number of key objectives for the 21st century, including: (i) to ensure that older people are able to live independently in their own homes; (ii) to ensure that older people are able to live in their own communities; (iii) to ensure that older people are able to live in good health and be able to take part in the activities of their communities; (iv) to ensure that older people are able to live in dignity and respect.

The White Paper also sets out a number of key objectives for the 21st century, including: (i) to ensure that older people are able to live independently in their own homes; (ii) to ensure that older people are able to live in their own communities; (iii) to ensure that older people are able to live in good health and be able to take part in the activities of their communities; (iv) to ensure that older people are able to live in dignity and respect.

The White Paper also sets out a number of key objectives for the 21st century, including: (i) to ensure that older people are able to live independently in their own homes; (ii) to ensure that older people are able to live in their own communities; (iii) to ensure that older people are able to live in good health and be able to take part in the activities of their communities; (iv) to ensure that older people are able to live in dignity and respect.

The White Paper also sets out a number of key objectives for the 21st century, including: (i) to ensure that older people are able to live independently in their own homes; (ii) to ensure that older people are able to live in their own communities; (iii) to ensure that older people are able to live in good health and be able to take part in the activities of their communities; (iv) to ensure that older people are able to live in dignity and respect.

1 Microwave Catering

Hardly a month passes without one or other of the professional catering journals mentioning the microwave process, and the reader is referred to such journals if he is seeking guidance on the most profitable way to use microwave ovens in business. The purpose of this Chapter is to outline the benefits of the system.

Where large scale catering is concerned, the close alliance between microwave heating and preserved foods (usually refrigerated or frozen) offers increased commercial flexibility and reduced overall costs. At the same time the speed of microwave cooking and heating ensures that less flavour and nutrition is lost than with the other heating methods commonly used. By combining deep-freezing and microwave heating one can get vegetables that taste as though they had been growing in the garden an hour before and meat that is tender, succulent and tasty. This method of catering will improve rather than depreciate our standards of eating.

1.1 The Process of Heating

With the traditional methods of heating food it is only the surface that gets the direct heat; the rest is warmed by conduction, and in liquids by convection. The rate at which food is cooked depends on the maximum surface temperature that can be tolerated and the speed at which the heat can be transferred to the interior.

Fundamentally the same is true of microwave heating, but with the difference that the applied energy penetrates to a much greater depth. For instance, two and a half centimetres below the surface of a joint of meat the transfer of energy – the actual heating – is still a half of what it was at the surface. The increased penetration, compared with infra-red heating, is due to the much longer wavelength of the electro-magnetic radiation. The whole body of a portion of food is thus brought to the proper temperature in only a fraction of the time required by other methods.

With fish, poultry, and joints of meat, the advantages of this fast uniform heating process are tenderness, flavour, and juiciness. Of course, one can never get *crackling* on a joint of pork, since this is a product of

high surface temperature. There are other things that straight microwave cooking cannot do, but in every case a judicious combination of microwave and ordinary cooking will lead to a better product than hitherto.

One consequence of this fast cooking is that it accentuates some of the difficulties present with ordinary methods. Timing must be particularly accurate, a minute more or less makes no difference ordinarily, but if the total cooking time is only three minutes then one minute makes a deal of difference. Obviously an accurate timer is an essential part of the oven. Another problem is uniformity of heating; normally a cook has time to turn joints and so on to ensure that they are evenly cooked, but the few minutes of microwave cooking leaves no time for this – it is up to the oven designer to ensure that cooking is as uniform as possible.

Where microwave ovens are used as an adjunct, as one of the many tools of the resourceful cook, the art and skill of cookery are as essential as ever. On the other hand, where an automated process is called for, as with vending machines for example, the microwave process is the one most easily adapted. It is fast, the results are predictable, and the end product both nutritious and delicious.

The depth to which electromagnetic energy penetrates is a function of wavelength; the longer the wavelength, the greater the penetration. Against this must be weighed the effect of the dependence of heat absorption on wavelength. Fig. 1.1 shows how the absorption of water changes with wavelength – water is the most important constituent of food as far as microwave heating is concerned. The other materials concerned, fat, muscle, bone, etc., have different curves but, taken overall, they have much less bearing on the heating than the behaviour of water. Of the frequencies allocated to general industrial use, that most practicable for cooking and heating foods is at 2.45 GHz, with a free space wavelength of 12.2 cm.

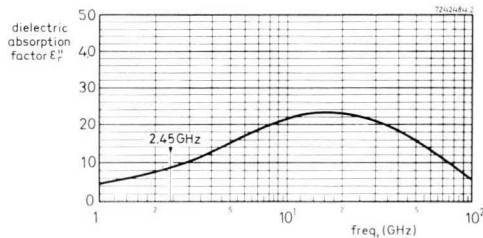

Fig. 1.1. Dielectric absorption factor ϵ_r of water as a function of the frequency.

Microwave heating is similar in principle to the dielectric heating process that has been used in industry for many years. With dielectric heating the material to be heated is placed between the plates of a capacitor to which a radio frequency voltage is applied. The r.f. field produces sympathetic changes in the orientation of dipoles in the material, as shown in Fig. 1.2. These changes of orientation give frictional losses that heat the material. For such capacitive heating to be uniform the mechanical dimensions of the capacitor itself must be physically small in comparison with the wavelength employed, so this method is ruled out at 12.2 cm.

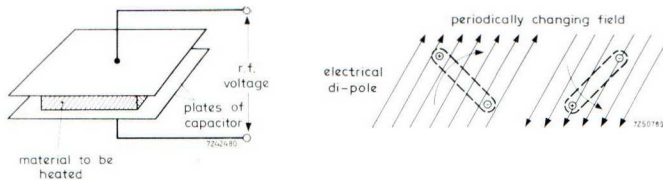

Fig. 1.2. Principle of dielectric heating, showing the changes produced in the orientation of the dipoles in the material.

The usual way of supplying the microwave energy is to place the food in a multi-resonant cavity in which a complex microwave field can be excited. As with the capacitive method, the food is heated by molecular friction losses. Various methods are used to ensure that the effect is uniform through the body of the food.

1.2 Practical Considerations

Microwave catering appliances are made in a wide range of heating powers and in at least two basic forms – normal oven (up to 2 kW) and conveyer belt (over 2 kW). The first is used in the home, in cafés and restaurants; the second in food factories, in large cafeterias, factory and military canteens, hospitals, in fact anywhere meals are produced in quantity.

The cavity oven, which looks much like the ordinary sort of oven, is the one that commands the mass market. In a very few years there will hardly be a café or restaurant that cannot boast at least one. As production increases, the price will come down and more and more ovens will appear in domestic kitchens.

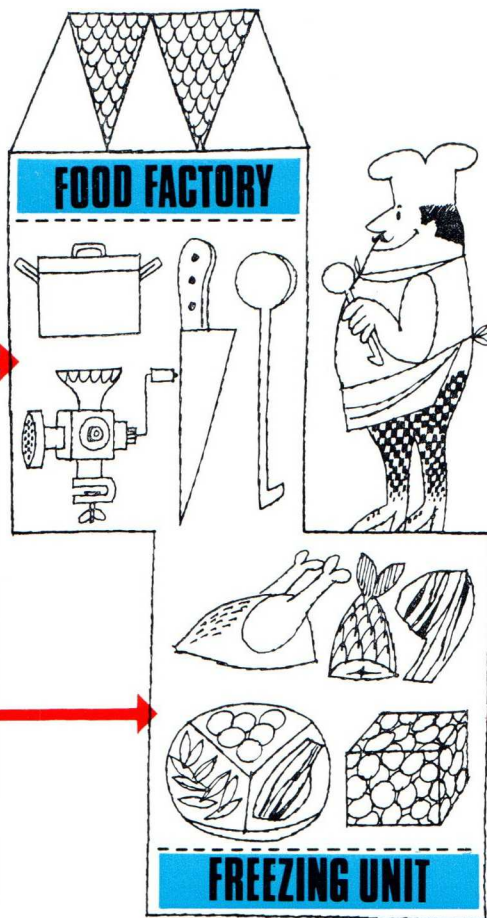
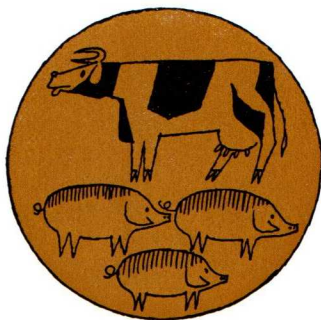
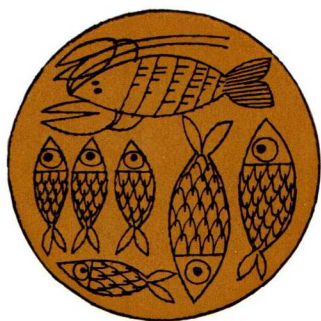

HOSPITAL CENTRAL KITCHEN

SPECIAL DIETS
BULK PREPARED FOOD
COMPLETE MEALS



MILITARY BASE DEPOT

mobile
microwave
oven

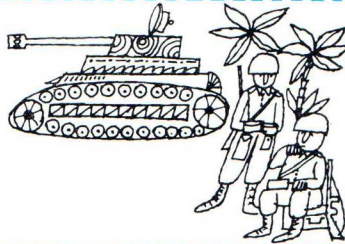

DOMESTIC KITCHEN



RESTAURANT KITCHEN



CAFETERIA KITCHEN

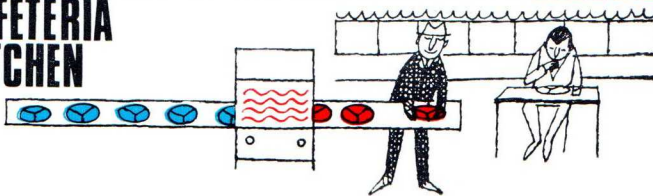

Microwave ovens are used in normal restaurants, often complementing the more traditional equipment. They are used to heat locally refrigerated pre-cooked meals, so that a full menu can be maintained throughout the day without the need of long working hours for the kitchen staff. Microwave ovens are also used in the quick preparation of soups and snacks, often keeping customers content while the main course is prepared. To a growing extent they are used to heat specially constituted factory-prepared deep-frozen meals for a cafeteria type service. Here they tend to overlap with conveyor belt ovens which are also used mainly for the same type of service.

Conveyor belt ovens lend themselves readily to fully automated catering systems. In the design of Automatic Food Supplies Ltd., of Växjö, Sweden, who have patents pending on various aspects of the equipment, a wide range of meals can be selected by a remote ordering installation, and delivered to the microwave oven by conveyor belt from magazines housed in a deep-freeze store. After being heated for an appropriate time, the meal is transferred to a pneumatic system that delivers the meal, piping hot, to the place where it was ordered, and which may be as much as a kilometre away. The system also delivers cool drinks from a separate refrigerator.

The system described was primarily designed for hospitals who are among the greatest sufferers from the shortage of domestic and kitchen staff, but schools and factory canteens are also among the institutions that have ordered the system. A café in Växjö also uses a modified version (the pneumatic tube is unnecessary) to provide a full range of restaurant meals throughout the normal working day, and a coin operated service when the café is closed. The system has been a commercial success in this comparatively small, and to some extent conservative, community.

Conservatism in matters of food is one of the difficulties facing the go-ahead caterer. However, greater progress must be made in catering if people are to eat out more and more and are to enjoy appetising food in congenial surroundings at acceptable prices. Economics are against *cordon bleu* cooking all round the clock in restaurants. The *cordon bleu* cooking must be done in factories and the products reheated by some non-depreciatory means such as a microwave oven.

The greatest problem facing the users of ordinary factory prepared meals at the moment is that the only really successful conservation system is deep-freezing which may give problems with microwave heating. The reason is that pure ice absorbs microwave energy to a much less extent

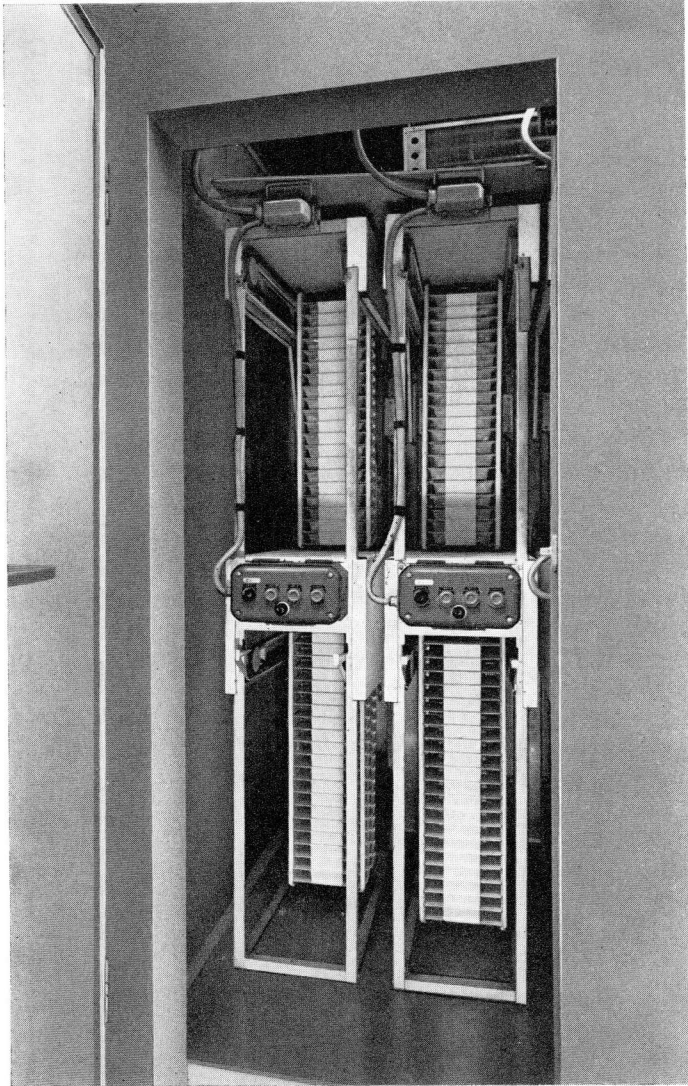

*Automatic food delivery equipment installed in a deep-freeze store.
(By courtesy of Automatic Food Supplies Ltd., Växjö Sweden.)*

than water. If there is any unevenness in the distribution of microwave energy or the composition of the meal, it is accentuated because parts that defrost first start to cook and absorb the greater part of the available microwave energy before other parts have been defrosted. This can be overcome by specially constituted and prepared frozen meals.

1.3 Summary of the Benefits of Microwave Catering

Most of the benefits of microwave cooking stem from its speed and simplicity of operation that allow a reduction in time and labour needed at both the heating and serving stage. It is also speed that ensures a significant reduction of the time that food spends in the bacterial danger zone between 20 °C and 80 °C; speed that means tenderness and juiciness in the finished product; speed that ensures much less nutritive loss, and a much better appearance – particularly with green vegetables.

However, once one has separated the stages of preparation (including cooking) from the stages of heating and serving, as the microwave process allows, a whole host of ancillary benefits accrue. For one thing the kitchens of cafeterias, factory canteens, hospitals and so on, can be smaller.

Cost control becomes easier as well; apart from accurate portion control, there is no loss from food being prepared but not ordered. In general, the outgoings are completely predictable.

2 The Magnetron

The magnetron is the heart of any microwave heating system and the design of microwave catering equipment requires a thorough understanding of its operation and application. Since this chapter can only briefly outline the basic principles involved, the reader is recommended to request our advice on the selection and use of magnetrons for microwave catering equipment.

2.1 Principles of Operation

The magnetron is a form of vacuum diode. It consists of a cylindrical anode block separated by an interaction space from a heated axial cathode. A high potential is applied between anode and cathode, and there is a strong magnetic field along the axis of the tube.

Under the influence of the electric field alone, electrons leaving the cathode would travel radially across the interaction space to the anode. With the magnetic field alone, they would describe paths bringing them back to the cathode. With both magnetic and electric fields their paths become cycloidal and tend towards the anode, see Fig. 2.1.

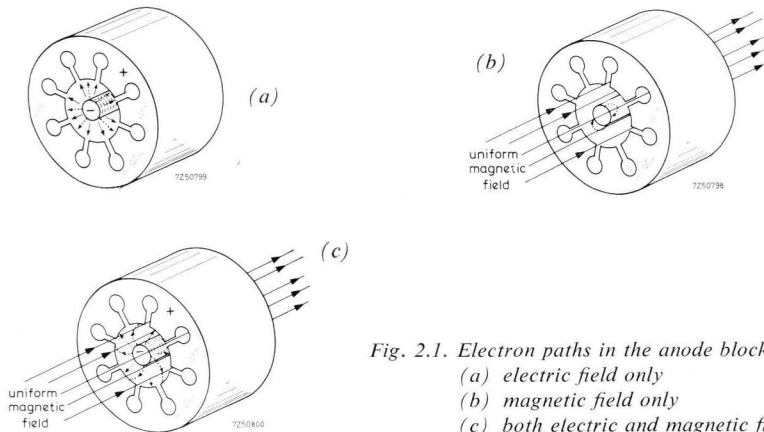

Fig. 2.1. Electron paths in the anode block:
(a) electric field only
(b) magnetic field only
(c) both electric and magnetic fields.

The multi-cavity anode shown in Fig. 2.2 is of the type known as *hole-and-slot*, and is the classic form of magnetron anode block. Each cavity forms a tuned circuit, the cavity wall forming the inductive component and the slot the capacitive component. The size of the hole and slot determine the resonant frequency of each cavity. The initiation of the flow of anode current is enough to trigger electrical oscillations in the cavities. These oscillations generate electric fields, the fringes of which penetrate into the interaction space and influence the paths of the electrons.

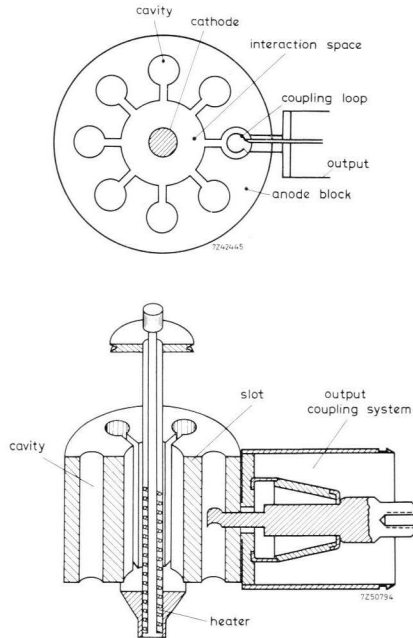

Fig. 2.2. Constructions of a "hole and slot" magnetron.

The electrons are either accelerated or decelerated, depending on the direction of the electric field at the moment they enter it. (See Fig. 2.3) Electrons that are accelerated absorb energy from the oscillating field and describe paths that bring them back to the cathode, where their

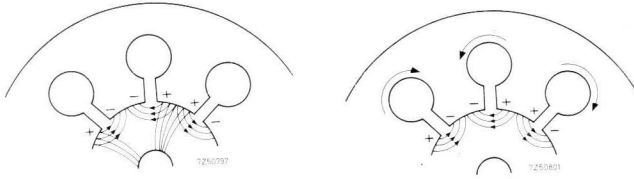

Fig. 2.3. Field patterns at the slots of the cavities.

kinetic energy causes more (secondary) electrons to be ejected. Decelerated electrons, on the other hand, give up energy to the oscillating field and while doing so follow a path that brings them opposite the next slot.

While the electron has moved from one slot to the next the electric field has reversed, and again the electron is retarded. So travelling towards the anode in a series of small cycloids, crossing several slots on the way, a favourable electron will give all or nearly all of its energy to the oscillating field. It transfers to the oscillating field energy it gains from the d.c. field. Accelerated electrons remain in the field so short a time that they absorb little energy from it. There is thus a considerable surplus of r.f. energy, above that required to maintain the oscillating field, that can be coupled to an r.f. load.

From Fig. 2.4 it will be seen that the electrons in the interaction space are at any instant grouped opposite slots that are receiving energy and that as the oscillating field rotates about the cathode, so will the electrons rotate as a spoke-shaped cloud. By an effect known as *phase focussing* (Herringer-Hülster effect) electrons that tend to fall behind the others absorb energy from the r.f. field and are kept in phase: electrons that

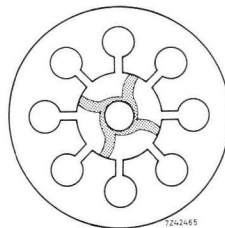

Fig. 2.4. Representation of the spoke-shaped clouds of electrons in a magnetron.

tend to get too far ahead give up energy to the field and are pulled into line. The angular velocity of the spokes is constant, and every time a slot is passed, energy is imparted to the cavity.

Although this description is based on the hole-and-slot type of magnetron it is also applicable to other types, including the "vane" magnetron shown in Fig. 2.5.

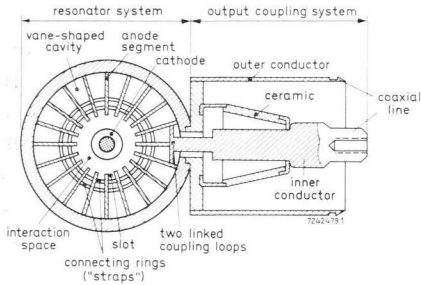
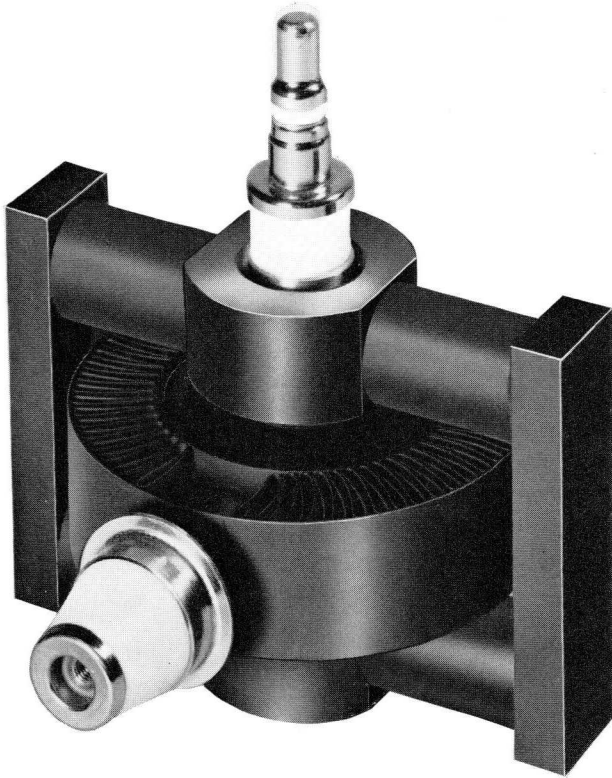

Fig. 2.5. Cross-section of a vane type magnetron.



The cathode structure and the anode block of the 1/1.5 kW magnetron YJ 1280.



*Continuous wave metal-ceramic air-cooled magnetron YJ1280.
It develops 1|1.5 kW output power within the frequency band
2.425 to 2.475 GHz.*

2.2 Parasitic Oscillations (Moding)

In vane type magnetrons, the cavities are designed to oscillate at the same frequency. They are, however, very close to each other and are coupled by their radiated energy. Because of this, and because the vanes and cavities form a closed delay line that is resonant at several frequencies, it is possible for oscillations to be set up at frequencies other than that intended.

Magnetrons are normally designed to operate in the π -mode in which the spoke-shaped clouds of electrons pass two slots during one cycle of oscillation. Undesired modes produce spokes that appear to rotate faster or slower than the fundamental; such parasitic oscillations are usually referred to as *moding*.

With a vane type magnetron several frequencies of oscillation are possible, each one is determined by the anode voltage and the magnetic field strength. When the magnetic field strength is fixed, as when permanent magnets are used, the different modes are excited at different anode voltages, the π -mode occurring at the lowest voltage. However, for magnetrons operating at 2.45 GHz, there is little frequency difference between the π and the $\pi - 1$ mode, so there is always a tendency for both modes to be excited.

One way of improving stability so that only the desired (π) mode is excited, is to strap alternative cavities together as shown in Fig. 2.6. As long as the $\pi - 1$ mode is unloaded, however, there is always the danger that it may be excited. One way of avoiding excitation of the $\pi - 1$ mode is to damp its circuit. In principle this can be done internally, but it is more practical to do it externally. If the output coupling of the magnetron has a broad bandwidth, the normal load can itself be used to damp the $\pi - 1$ mode.

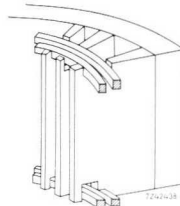

Fig. 2.6. Strapping alternative cavities to excite the correct mode.

Where the magnetron output coupling is broadband, the designer of an appliance should ensure that all subsequent matches – such as magnetron to waveguide, and waveguide to cavity are also broadband, otherwise the object would be defeated. It is of further advantage to adjust the length of the waveguide so that the loading of the π and $\pi - 1$ modes are brought into their respective phases of sink.

2.3 Cathodes

The surface of the cathode must be such that it will readily emit electrons when heated, and yet have sufficient mechanical strength to withstand the electron bombardment that contributes so largely to its temperature. Cathodes may be either directly or indirectly heated. Direct heating has the advantage that little delay is required between switching on the heater supply and applying anode voltage, while indirectly heated cathodes have greater thermal capacity. Delay is of the order of 10 secs for directly heated cathodes, and 3 or 4 mins for indirectly heated cathodes.

Typical among high-quality indirectly heated cathodes is the “dispenser” type. The body is made of porous sintered tungsten to form a cylinder, inside which is mounted the heater. The cathode is impregnated with emissive material. Under correct operating conditions, the loss of emissive material at the surface is balanced by the thermal diffusion of impregnant through the pores of the sintered tungsten. Directly-heated types often have helical cathodes.

2.4 Output Coupling

In the magnetrons considered here, the energy output is obtained by means of two linked coupling loops, which act together on the inner conductor of the magnetron output system, from two adjacent cavities. The inner conductor and a coaxial outer conductor form a coaxial transmission line through which the energy transfer takes place; the inner and outer conductor of the magnetron output system are to be connected to their counterparts in the equipment.

The inner conductor of the (coaxial) output is sealed to the resonator system by means of a conical vacuum-tight ceramic-metal connection, which gives great mechanical stability.

2.5 Power Supplies

A magnetron requires a high-voltage anode supply and a heater supply. The anode supplies for magnetrons described here are in the range of 1.65 kV to 7 kV, and may be either a.c. or unfiltered d.c. The majority are designed for unfiltered d.c., because this enables a simple circuit to be employed and gives a higher output efficiency. The magnetron is a current-fed device and there are two points requiring special consideration. These are the ratio of peak to mean anode current, and mean anode current stabilization. Power supplies are discussed in more detail in Chapter 5.

2.6 Cooling

The conversion of the energy of the electrons into useful energy is necessarily a wasteful process. Due to the impact of the electrons on the anode block, considerable heat is generated by their residual kinetic energy and this heat must be dissipated. In order to maintain an adequate thermal gradient from the internal surfaces of the anode block to the ambient air, the external surface of the block is cooled by forced air, or water. Generally, low-powered magnetrons are air-cooled and high-powered ones water-cooled. Our 2/2.5 kW magnetrons are made in two versions, thus offering alternative methods of cooling.

2.7 R.F. Interference

Modern c.w. magnetrons are designed with built-in devices to reduce r.f. leakage from the input structure to a minimum. Most countries have legislation imposing limits on r.f. interference in the communication bands, which must be complied with. This subject is discussed in greater detail in Chapter 6.

3 Operating Characteristics

The operating characteristics of a magnetron are dependent on its load. The load is determined by the r.f. system into which the magnetron operates. In such a system, account must be taken of the reflection that occur. It is not within the scope of this book to discuss r.f. reflections in detail, but a brief mention of the effects will assist in explaining the operating characteristics of magnetrons.

3.1 V.S.W.R.

When a sinusoidal voltage such as that shown in Fig. 3.1 is applied at the end of a transmission line, a voltage wave is propagated down the line at a velocity determined by the characteristic impedance of the line. If the line is terminated with its characteristic impedance, i.e. is matched, all of the power transmitted will be absorbed by the load. If the line is not matched, a reflected voltage wave will be propagated back up the line to the source. The amplitude of the reflected voltage wave will depend on how much power has been absorbed.

In the situation just described two waves, the incident and the reflected, differing in their directions of propagation exist in the transmission line at the same time. If an instrument insensitive to the direction of propagation were inserted in the line, it would indicate the sum of the two voltage waves at any instant. The sum depends on the amplitudes of the waves,

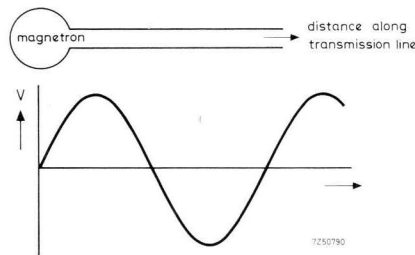

Fig. 3.1. Propagation of a voltage wave down a transmission line.

and on their phase relationship. The phase of the reflected wave will depend on the inductive or capacitive reactance of the load.

Fig. 3.2 shows the case of incident and reflected waves having differing amplitudes and phases. The illustration is subdivided to illustrate the conditions at successive instants t_0 , $t_0 + 90^\circ$, and $t_0 + 180^\circ$. The fourth figure shows the sums of the waves superimposed; it can be seen that the points at which maximum and minimum values of resultant voltage occur are fixed for a given situation. They do not move along the line as do the incident and reflected waves. From this property they have derived the name *standing-waves*, and can be briefly defined as the resultant of incident and reflected voltage waves occurring in a transmission line.

One way of observing and measuring standing waves is to use a slotted transmission line. This is a line with a slot in the direction of wave propagation, such that energy does not leak from it. A probe can be inserted through the slot so that it can couple into the waves and pick off a small portion of the signal. The signal from the probe is usually rectified and fed to a standing wave meter. As the probe is moved along the slot, positions of maxima and minima may be noted and from these figures the relationship of incident and reflected waves can be calculated.

It will be obvious that reflected energy resulting from a mismatched load or discontinuity will affect the operation of a magnetron. As will be seen later, a certain mismatch is desirable as it leads to the most efficient operation of the magnetron.

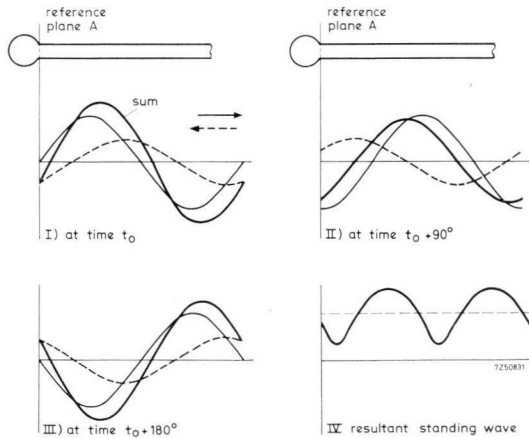
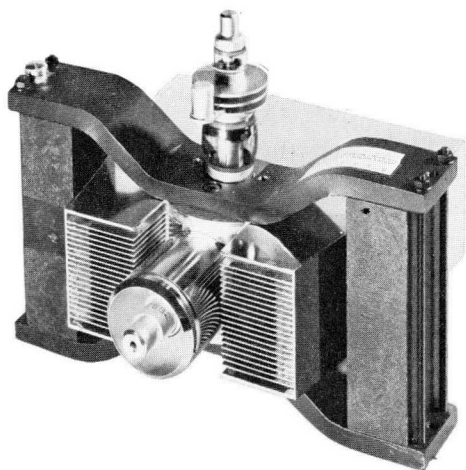

Fig. 3.2. Incident and reflected waves having different amplitudes and phases.



The YJ1162 continuous wave air-cooled magnetron develops 2½ kW output power within the frequency band 2.425 to 2.475 GHz.

From the description of standing-waves it will be clear that as the relative phase of incident and reflected waves varies so the position of maximum (anti-nodes) and minimum (nodes) of the standing-wave will move along the line. From this it follows that if the position of the maximum and the minimum of the standing wave along the line is known, the phase difference between reflected and incident waves can be calculated. Also, if the ratio of the maximum to minimum voltage of the standing wave is known, then the relative amplitudes of incident and reflected waves can be derived. The ratio of the maximum to minimum voltage (V_{\max}/V_{\min}) is known as the voltage-standing-wave-ratio (v.s.w.r.).

With a slotted line the v.s.w.r. and the distance (d) of the first standing wave minimum can be measured from an arbitrary reference plane. The measurement of d is in terms of the wavelength (λg) of the signal in the line, and because nodes occur at half wavelength intervals along the line, will vary between 0 and $0.5 \lambda g$. The v.s.w.r. (V_{\max}/V_{\min}) will vary between 1 and ∞ , unity being indicative of a perfect match.

3.2 Characteristics

The two widely used methods of displaying the characteristics of magnetrons are the performance chart and the load diagram.

3.2.1. PERFORMANCE CHART

The performance chart gives average values of anode voltage (measured with smoothed d.c.), output power and efficiency (measured with unsmoothed d.c.) as functions of anode current, with reference to a matched load or with precisely defined mismatches. From Fig. 3.3 it can be seen that with this type of magnetron at an anode current of 0.75 A, the output power is 2 kW with an efficiency of 55% approximately. Note that the magnetron starts oscillating as soon as the anode voltage is higher than the so called *threshold* voltage. If the anode voltage is below this

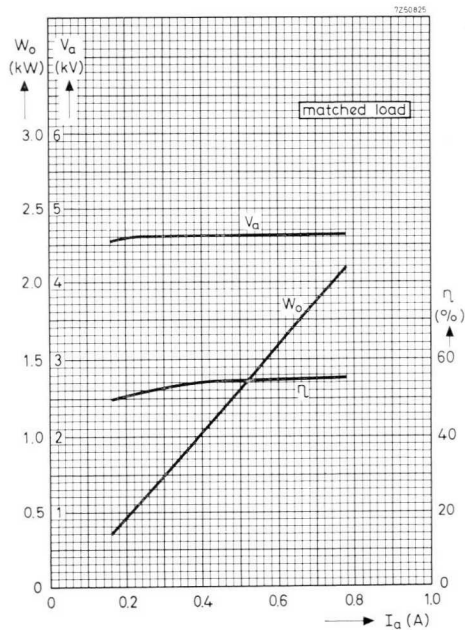

Fig. 3.3. Typical performance chart for a 2 kW magnetron. Output power W_o , anode voltage V_a , and efficiency η are shown as functions of the anode current I_a .

threshold level only a very small current, due to side emission from the cathode, will flow. Above the threshold a small change of anode voltage will cause a large change in anode current.

The curve given for the anode voltage is related to the specified magnetic field. A higher magnetic field will give higher operating voltage, a lower field the converse. The choice of magnetic field is based on high efficiency operation, coupled with stability requirements.

3.2.2. The Load Diagram

The load (or Rieke) diagram is a variant of the Smith chart and shows the operation of the magnetron as a function of the coupled load impedance presented to its output terminal. The load diagram for a typical magnetron is shown in Fig. 3.4.

The coupled load impedance can be expressed as v.s.w.r. and a defined phase angle with respect to a given reference plane. It is normal to define the reference plane as being at the magnetron output terminal. The phase angle (d) is expressed in fractional wavelengths measured from the reference plane towards the load. The load diagram consists of concentric circles, each circle representing a constant v.s.w.r., and of radial intersections which give the phase relationship with respect to the reference plane.

Power output lines are given as a function of load impedance, phase and change in frequency. In the direction of approximately 0.41λ it will be seen that the power output is greatest, and also that lines of frequency change converge. This is called the *direction of sink*. The opposite side of the diagram, i.e. 0.15λ , indicates the direction of the anti-sink or *off-sink* region.

The load diagram gives no information regarding the anode voltage needed to obtain the required constant anode current on which the diagram is based. In the phase of "sink" the required anode voltage is slightly higher than required under matched conditions, which means a slightly increased input power. However, the increase in output power is such that the total efficiency of the magnetron is higher than under matched conditions, which means that anode dissipation is reduced. By operating in this region the anode current can be increased to obtain even more output. That reflections in the "off-sink" region give lower output power and increased dissipation is a further reason for operating a magnetron in or near the "sink" region.

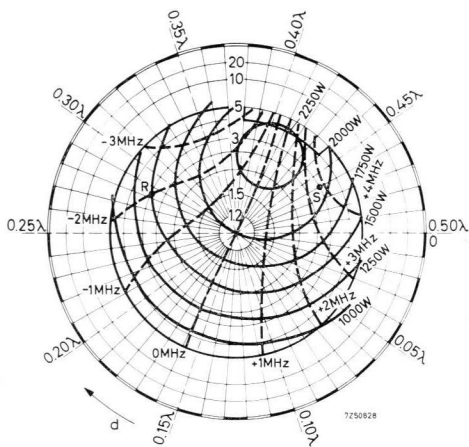

load diagram operation A
 mean anode current 0.75A
 peak anode current 2A
 d=distance of standing wave minimum
 from reference plane A towards load

Fig. 3.4. Load diagram of a typical 2 kW magnetron. Contours of constant output power (full lines) and frequency (broken lines) as functions of the VSWR (1 to ∞) and distance d of the standing wave minimum from reference plane A.

Due to normal production spreads, the position of phase of “sink” will differ slightly from one magnetron to another. Too high a v.s.w.r. in the sink region can cause moding, voltage breakdown, and may cause the output systems to overheat. Too high a v.s.w.r. in the off-sink region can cause excessive anode dissipation due to the low efficiency, which can shorten the life of the magnetron.

3.3 The Working Point

If with a given magnetron and load system the magnetron is working at or near the matched condition, the output and efficiency can be increased by introducing a fixed reflection element between the magnetron and its load to shift the working point to the “sink”. Such operation allows an increase in magnetron current and it becomes possible to re-draw the load diagram as shown in Fig. 3.5.

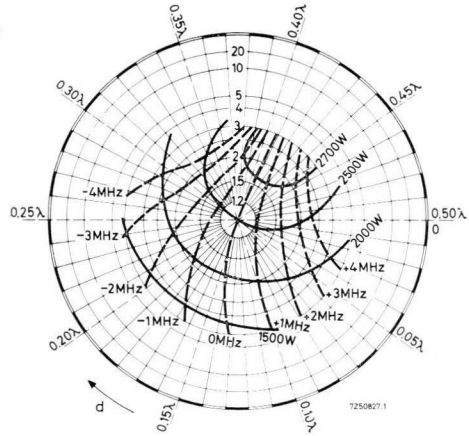
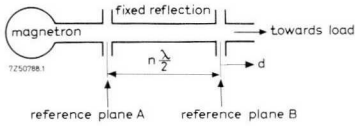

load diagram operation B
 mean anode current 0.85 A
 peak anode current 2 A
 fixed reflection VSWR = 1.5 $d = 0.41\lambda$
 d = distance of standing wave minimum from
 reference plane B towards load

Fig. 3.5. Load diagram showing the effect of introducing a fixed reflection element between the magnetron and its load to shift the working point to the "sink" and increase the power output and efficiency. Compare this diagram with Fig. 3.4.

In our example the reflection element has a v.s.w.r. of 1.5 with a phase shift of 0.41λ and the magnetron current is increased to 0.85 A. It should be noted that operation in this region restricts the maximum permissible v.s.w.r. and that the reference plane has been moved to the load end of the reflection element.

If a magnetron is coupled to its load by a coaxial line or waveguide, the phase of the reflection coefficient can be changed without altering the v.s.w.r., by varying the length of the line. This will be clear if it is remembered that reflection occurs at the point where the line is coupled to the load, and that the distance d is measured from a specified reference plane. As identical conditions exist at intervals of $\lambda g/2$ along the line, no change of conditions will occur if the length of line is varied by multiples of $\lambda g/2$. If, on the other hand, the length of line is altered by an amount other than a multiple of $\lambda g/2$, the reflections will be moved into another phase. The magnetrons with which we are concerned operate at

a nominal free-space wavelength of 12.2 cm (i.e. $f = 2.45$ GHz), therefore $\lambda/2 = 6.1$ cm.* To illustrate this, point R in Fig. 3.4 gave a useful output power of 1.5 kW at an operating frequency 2 MHz below the nominal. The v.s.w.r. was 3.0 with $d = 0.28 \lambda$. If the coaxial line connecting the magnetron to its load is extended by 2.3 cm (0.18λ), d will become 0.46λ ($0.28 + 0.18$). The new operating point will then be at S where the useful output power is just over 2.25 kW and the operating frequency almost 4 MHz above the nominal.

In connection with this it will be remembered that in Chapter 2 we mentioned the possibility of reducing the chance of moding, by loading the $\pi - 1$ modes in their phase of sink. Because their frequencies, and therefore their wavelengths, differ from that of the π mode, it is possible to move the load on the frequencies of the $\pi - 1$ modes into the phase of sink without changing the position of the load on the π frequency simply by adding an appropriate length of line between magnetron and load.

Fig. 3.6 shows the load diagram of a magnetron connected to a resistive load by a line 11 cm long: the working point for the normal mode is shown at point 1, i.e. in the phase of sink; the loading point for one of the $\pi - 1$ modes is shown at point 2, well away from the sink region for this mode. If another 6.1 cm of line are added between magnetron and load the working point of the π mode will be shifted 360° , i.e. it will remain in the same phase, but the loading point for the $\pi - 1$ mode will be shifted through *more than* 360° - to the new point at 3 - in the phase of sink for this mode. As a result, the $\pi - 1$ mode will be heavily damped and the risk of moding will be much reduced.

With microwave ovens, of course, the load is a changing one, and we must think in working *regions* rather than points, but the same reasoning holds good. Fig. 3.7 shows the normal working regions for a 2.45 GHz magnetron with moding frequencies of 2.95 GHz and 3 GHz.

The loading regions of the unwanted modes are to be found close together in another part of the diagram. If moding is to be prevented, the magnetron must be operated in region 4 where it is less efficient, unless an additional length of line 6.1 cm long is interposed between magnetron and load. This shifts the working region for the moding frequencies to regions 5 and 6 where they are heavily loaded; the magnetron can now operate in the region of highest power and efficiency without the danger of moding.

* Where a waveguide is used, account must be taken of λ_g , the wavelength in the waveguide. In air-spaced coaxial systems the wavelength is the free-space wavelength.

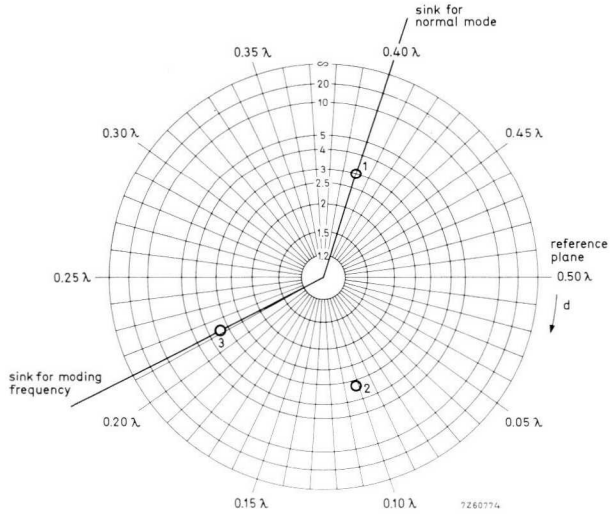

Fig. 3.6. Sink region and working point for the normal and for the moding frequency of a magnetron working into a resistively loaded line.

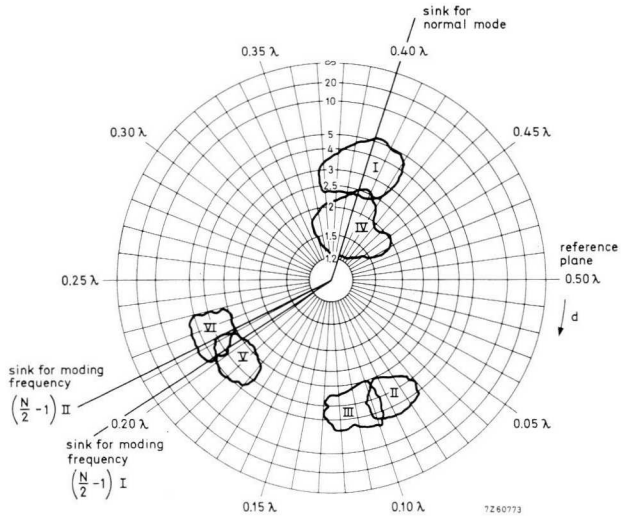
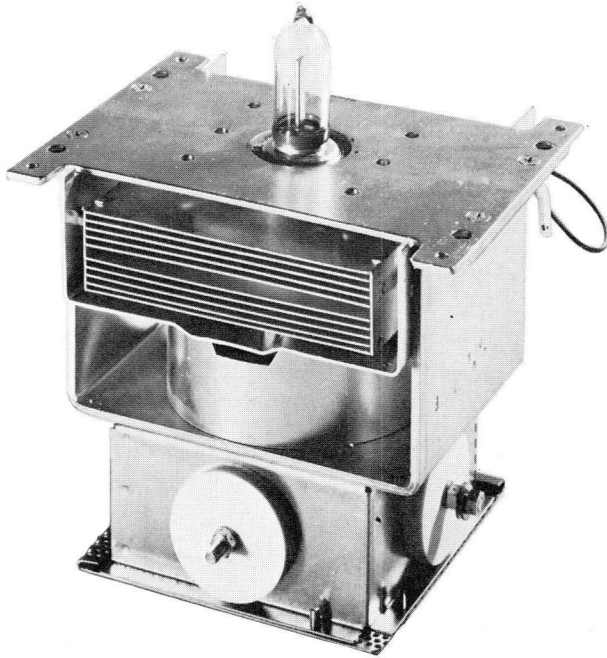

Fig. 3.7. Sink region and working points for the normal and for the moding frequency of a magnetron working into a cavity.

3.4 The Load

The heating effect of microwave energy on a given material is dependent on dielectric constant and loss factor, both of which vary with temperature and moisture content. As these parameters change during the heating process, the load presented to the magnetron will also vary. It is an important part of the oven designer's job to ensure that all likely load conditions are within the safe working range of the magnetron.

In the next Chapter we will consider the different ways in which microwave energy can be fed into a workload, in our case into a portion of food.



The YJ1420 continuous wave magnetron, which has an integral magnet and filter, develops typically 900 W output power. This magnetron has been specially design for domestic microwave ovens.



For lunch-time metals and evening snacks, a fast and useful service can be provided without extra manpower when a microwave oven forms part of the establishment.



This 2.1 kW oven operates on 2.450 GHz and may be switched to operate at half power, if required. The oven walls are of stainless steel and the cavity dimensions are 505 mm (20") wide by 275 mm (11") deep by 220 mm (9") high. (By courtesy of Philips Domestic Appliances Division, Eindhoven, The Netherlands.)

4 The Microwave Oven

The usual microwave oven is of the multi-mode cavity type. It resembles in external appearance the normal domestic oven.

4.1 Excitation Modes

In principle, a resonant cavity is a closed waveguide, so dimensioned as to resonate at one or more chosen frequencies. When microwave energy is fed into a waveguide, electric and magnetic field patterns are generated that propagate the energy along it. Fig. 4.1, shows one of the modes of

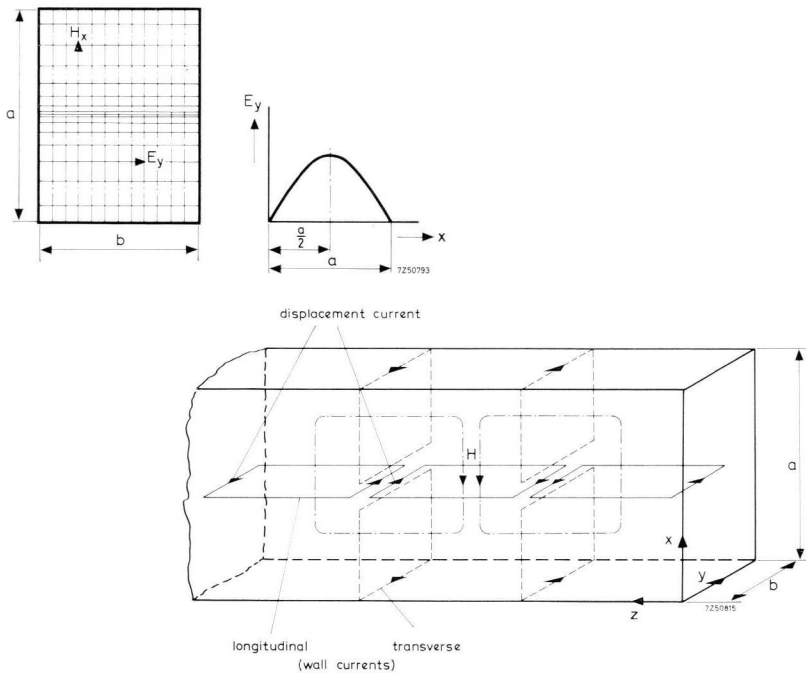

Fig. 4.1. Electric and magnetic field patterns in a closed waveguide.

propagation, the mode or field pattern at a particular frequency being determined by the dimensions of the waveguide. If the waveguide is closed, a standing field pattern will be generated that is characterised by points or areas of high and low intensity. Food placed in such a cavity will be unevenly heated.

If a cavity is of such a size and shape that many modes can be excited, the areas of high and low intensity in the individual modes will overlap. A load placed in such a cavity will be more evenly heated. It should be noted that the load itself influences the mode patterns. Generally the number of modes capable of being excited in a cavity increases linearly with volume, but computer calculations and practical experience have shown that whatever the volume, small changes in dimensions may greatly influence the number of available modes. This is important in view of the manufacturing tolerances required in production cavities.

From Table 4.1 it will be seen that with a tolerance of 0.5 cm on dimensions of $50 \times 40 \times 40$ cm, the maximum number of modes available is 14 and the minimum 8. Whereas for the same tolerance on dimensions of $48.5 \times 38.5 \times 40$ cm, a maximum of 21 and a minimum of 18 modes will be available.

In general, a mode will be available for each resonant frequency determined by:

$$1/f_{\text{res}} = \frac{1}{2} \left[(m/a_x)^2 + (n/a_y)^2 + (p/a_z)^2 \right]^{\frac{1}{2}},$$

where a_x, a_y, a_z are the oven dimensions in the direction x, y, z respectively; and m, n, p are integers.

Each set of integers assigned to m, n, p will give a resonance frequency, some of which will fall within the band that concerns us—2.425 to 2.475 GHz. Typical results obtained from one cavity are shown in Fig. 4.2.

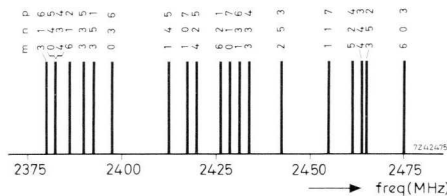

Fig. 4.2. Resonance peaks obtained in the frequency spectrum with a specific open cavity.

The repetitive calculation needed to solve this equation for all reasonable integers is rather tedious. For this reason we have a computer programme available which enables us to readily determine optimum dimensions from given target dimensions. Once a designer has decided the approximate size of a cavity, we will be pleased to run the computer programme to determine the best dimensions.



In this first class hotel a microwave oven relieves the pressure at peak periods and, at night, when customers make unforeseen requests for hot meals they can be supplied by one of the waiters at a moment's notice.

Table 4.1. Calculated results on the conceivable number of modes in oven cavities of given size

cavity dimensions	şəpou	cavity dimensions	şəpou	cavity dimensions	şəpou	cavity dimensions	şəpou	cavity dimensions	şəpou	cavity dimensions	şəpou	cavity dimensions	şəpou
$48.5 \times 38.5 \times 38.5$	14	$49.0 \times 38.5 \times 38.5$	16	$49.5 \times 38.5 \times 38.5$	17	$50.0 \times 38.5 \times 38.5$	16	$50.5 \times 38.5 \times 38.5$	12	$51.0 \times 38.5 \times 38.5$	12	$51.5 \times 38.5 \times 38.5$	16
39.0 15	39.0 18	39.0 16	39.0 16	39.0 16	39.0 16	39.0 16	39.0 16	39.0 16	39.0 12	39.0 12	39.0 12	39.0 16	39.0 16
39.5 17	39.5 18	39.5 17	39.5 17	39.5 17	39.5 17	39.5 17	39.5 17	39.5 17	39.5 13	39.5 13	39.5 16	39.5 17	39.5 17
40.0 21	40.0 19	40.0 19	40.0 19	40.0 19	40.0 19	40.0 17	40.0 17	40.0 15	40.0 13	40.0 15	40.0 17	40.0 17	40.0 17
40.5 18	40.5 18	40.5 17	40.5 17	40.5 17	40.5 17	40.5 16	40.5 16	40.5 12	40.5 12	40.5 12	40.5 14	40.5 15	40.5 15
41.0 15	41.0 14	41.0 12	41.0 12	41.0 12	41.0 12	41.0 13	41.0 13	41.0 10	41.0 10	41.0 10	41.0 17	41.0 17	41.0 17
41.5 14	41.5 16	41.5 15	41.5 15	41.5 15	41.5 15	41.5 17	41.5 17	41.5 15	41.5 15	41.5 15	41.5 17	41.5 19	41.5 19
$48.5 \times 39.0 \times 38.5$	15	$49.0 \times 39.0 \times 38.5$	18	$49.5 \times 39.0 \times 38.5$	16	$50.0 \times 39.0 \times 38.5$	16	$50.5 \times 39.0 \times 38.5$	12	$51.0 \times 39.0 \times 38.5$	12	$51.5 \times 39.0 \times 38.5$	16
39.0 18	39.0 18	39.0 15	39.0 15	39.0 15	39.0 15	39.0 18	39.0 18	39.0 15	39.0 13	39.0 13	39.0 17	39.0 17	
39.5 17	39.5 19	39.5 17	39.5 17	39.5 17	39.5 17	39.5 17	39.5 17	39.5 15	39.5 15	39.5 15	39.5 15	39.5 18	
40.0 20	40.0 20	40.0 18	40.0 18	40.0 18	40.0 18	40.0 18	40.0 18	40.0 15	40.0 15	40.0 15	40.0 17	40.0 17	
40.5 17	40.5 15	40.5 14	40.5 14	40.5 14	40.5 14	40.5 13	40.5 13	40.5 12	40.5 12	40.5 12	40.5 13	40.5 13	
41.0 13	41.0 12	41.0 9	41.0 9	41.0 11	41.0 11	41.0 11	41.0 11	41.0 12	41.0 12	41.0 12	41.0 13	41.0 13	
41.5 13	41.5 14	41.5 12	41.5 12	41.5 14	41.5 14	41.5 12	41.5 12	41.5 14	41.5 14	41.5 14	41.5 16	41.5 16	
$48.5 \times 39.5 \times 38.5$	17	$49.0 \times 39.5 \times 38.5$	17	$49.5 \times 39.5 \times 38.5$	17	$50.0 \times 39.5 \times 38.5$	17	$50.5 \times 39.5 \times 38.5$	13	$51.0 \times 39.5 \times 38.5$	13	$51.5 \times 39.5 \times 38.5$	17
39.0 17	39.0 19	39.0 17	39.0 17	39.0 17	39.0 17	39.0 17	39.0 17	39.0 15	39.0 15	39.0 15	39.0 18	39.0 18	
39.5 16	39.5 19	39.5 18	39.5 18	39.5 18	39.5 18	39.5 14	39.5 14	39.5 15	39.5 15	39.5 15	39.5 19	39.5 19	
40.0 19	40.0 17	40.0 15	40.0 15	40.0 15	40.0 15	40.0 14	40.0 14	40.0 11	40.0 11	40.0 11	40.0 14	40.0 14	
40.5 18	40.5 16	40.5 13	40.5 13	40.5 13	40.5 13	40.5 12	40.5 12	40.5 10	40.5 10	40.5 10	40.5 14	40.5 14	
41.0 15	41.0 13	41.0 13	41.0 13	41.0 13	41.0 13	41.0 13	41.0 13	41.0 12	41.0 12	41.0 12	41.0 14	41.0 14	
41.5 16	41.5 16	41.5 14	41.5 14	41.5 14	41.5 14	41.5 15	41.5 15	41.5 15	41.5 15	41.5 15	41.5 17	41.5 17	

48.5×40.0×38.5	21	49.0×40.0×38.5	19	49.5×40.0×38.5	19	50.0×40.0×38.5	17	50.5×40.0×38.5	13	51.0×40.0×38.5	15	51.5×40.0×38.5	17
39.0	20	39.0	20	39.0	18	39.0	18	39.0	15	39.0	15	39.0	15
39.5	19	39.5	17	39.5	15	39.5	14	39.5	11	39.5	11	39.5	14
40.0	19	40.0	13	40.0	15	40.0	14	40.0	10	40.0	10	40.0	10
40.5	17	40.5	12	40.5	13	40.5	12	40.5	9	40.5	10	40.5	12
41.0	15	41.0	13	41.0	12	41.0	12	41.0	11	41.0	13	41.0	13
41.5	16	41.5	14	41.5	16	41.5	14	41.5	14	41.5	15	41.5	16
48.5×40.5×38.5	18	49.0×40.5×38.5	18	49.5×40.5×38.5	17	50.0×40.5×38.5	16	50.5×40.5×38.5	12	51.0×40.5×38.5	14	51.5×40.5×38.5	15
39.0	17	39.0	15	39.0	14	39.0	13	39.0	12	39.0	12	39.0	13
39.5	18	39.5	16	39.5	13	39.5	12	39.5	10	39.5	14	39.5	12
40.0	17	40.0	12	40.0	13	40.0	16	40.0	9	40.0	10	40.0	12
40.5	13	40.5	12	40.5	8	40.5	11	40.5	9	40.5	8	40.5	13
41.0	12	41.0	11	41.0	10	41.0	11	41.0	10	41.0	10	41.0	12
41.5	13	41.5	14	41.5	13	41.5	11	41.5	12	41.5	13	41.5	14
45.8×41.0×38.5	15	49.0×41.0×38.5	14	49.5×41.0×38.5	12	50.0×41.0×38.5	13	50.5×41.0×38.5	10	51.0×41.0×38.5	14	51.5×41.0×38.5	17
39.0	13	39.0	12	39.0	9	39.0	11	39.0	12	39.0	12	39.0	13
39.5	15	39.5	13	39.5	13	39.5	13	39.5	12	39.5	14	39.5	12
40.0	15	40.0	13	40.0	13	40.0	12	40.0	11	40.0	13	40.0	13
40.5	12	40.5	11	40.5	10	40.5	13	40.5	10	40.5	10	40.5	12
41.0	13	41.0	11	41.0	10	41.0	10	41.0	11	41.0	11	41.0	16
41.5	13	41.5	12	41.5	12	41.5	14	41.5	13	41.5	14	41.5	14
48.5×41.5×38.5	14	49.0×41.5×38.5	16	49.5×41.5×38.5	15	50.0×41.5×38.5	17	50.5×41.5×38.5	15	51.0×41.5×38.5	17	51.5×41.5×38.5	19
39.0	13	39.0	14	39.0	12	39.0	14	39.0	14	39.0	14	39.0	16
39.5	16	39.5	16	39.5	14	39.5	15	39.5	15	39.5	17	39.5	17
40.0	15	40.0	14	40.0	16	40.0	14	40.0	14	40.0	15	40.0	16
40.5	13	40.5	14	40.5	13	40.5	11	40.5	12	40.5	13	40.5	14
41.0	13	41.0	12	41.0	12	41.0	14	41.0	13	41.0	14	41.0	14
41.5	11	41.5	11	41.5	12	41.5	13	41.5	11	41.5	12	41.5	14

4.2 The Cavity

Having decided the size and shape of the cavity, the next consideration is the material for the cavity walls. From the microwave aspect, the cavity is as big as its metallic walls; clothing them internally or externally with a dielectric makes very little difference.

Walls are often made of aluminium, but stainless steel is also used; particularly in countries where there are regulations governing the use of metals in food production. Stainless steel has a lower conductivity than aluminium and thus forms a greater permanent load on the cavity, which is not always a disadvantage.

An attractive alternative to aluminium or stainless steel is a plastic cavity covered with a metal foil layer. The conducting layer can be cut away where the microwave energy is to be injected, so that the plastic is thus left whole and is therefore easier to clean.

The cavity dimensions should be such that loading with food does not seriously interfere with the multi-mode resonances. For the best field distribution the cavity should not be so small that the food portions fill it, and multiple reflections from the cavity walls should be allowed to even out maxima and minima in the field. The food should rest on a tray of heat resistant glass or plastic to keep it away from the floor of the cavity, the tray could also serve as a small permanent load for the oven.

4.3 Microwave Leakage

Gaps or cracks in the metal structure of the cavity act as microwave radiators, the energy emitted being proportional to the wall current at the point of interruption. The distribution of current in the walls is not even, and in any case varies with the load in the oven, being greatest when the oven is empty. The edges of stainless steel ovens can be seam-welded to ensure good conductivity, but the door presents some difficulty, especially when accumulations of dirt or grease prevent good contact being made. Several methods of ensuring a good door seal are possible.

Pressure contacts, preferably with a wiping action, are excellent in this respect. An alternative solution is to use quarter wave slots around the edge of the door, various examples are shown in Fig. 4.3. The slots are filled with a dielectric or lossy material such as graphite, to prevent dirt accumulating in the slot; the size of the slot being adjusted to take account of the dielectric filling.

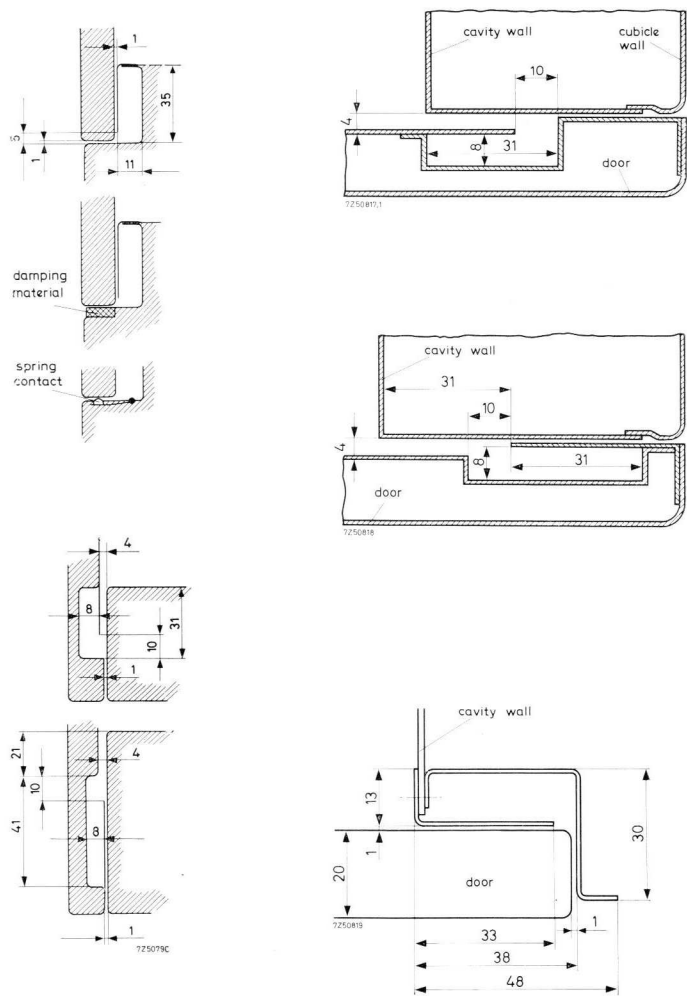

Fig. 4.3. Examples of quarter-wave slots around the edges of oven doors to minimize microwave leakage.

Care should be taken to make the door sufficiently rigid, so that small deformations do not create gaps that permit the loss of energy. If hinges are based on the rising-butt principle, conducting contacts will “wipe” and thus remain clean.

At least *two* independent safety devices should be incorporated to prevent the magnetron power supply being switched on until the door is *completely* closed or, perhaps more important, to switch the magnetron off should the door be opened during cooking.

4.4 Field Stirrers

Of the number of available modes in a given cavity, some will propagate in the plane xy , some in the plane yz and, some in the plane xz . For a mode to be excited it must be coupled to the excitation source, the source being either a waveguide opening into the cavity or a projecting antenna.

The best way of ensuring coupling to every possible mode is to use field stirrers that will continually vary the plane and strength of the excitation by deflection. The blades of the field stirrers act as re-radiators that continually change the microwave conditions in the cavity and, in the ideal case, ensure that every available mode is stimulated. Magnetron data sheets now allow a very high v.s.w.r. for limited periods during such cyclic variations as are caused by field stirrers. Examples of field stirrers are shown in Fig. 4.4.

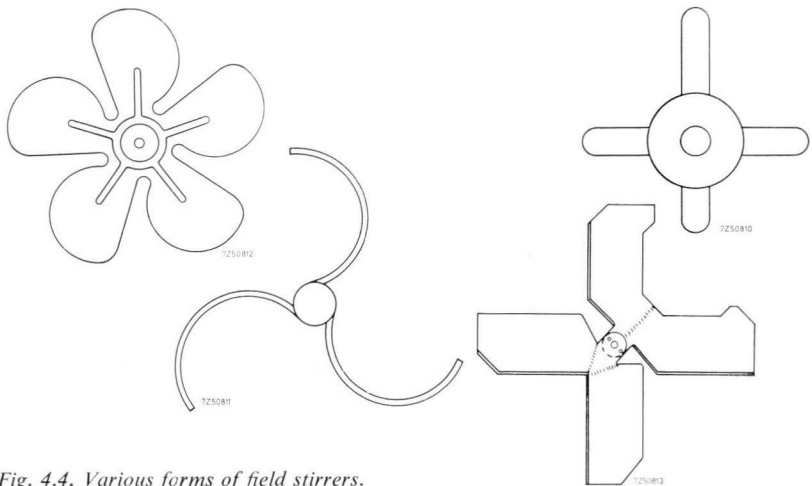

Fig. 4.4. Various forms of field stirrers.



In bar and café microwave ovens give excellent counter service. The oven takes up little space and, with a supply of food products which may be kept in the refrigerator, offers an attractive addition to the facilities available.

4.5 Coupling

Mention was made earlier of the choice between a waveguide or a direct antenna coupling into the oven space. In the past it was recommended that magnetrons be coupled direct to the cavity by an antenna screwed into the output coupling probe of the magnetron. Now, however, two separate lines of thought have shown definite advantage in providing a launching section (coaxial or waveguide) between magnetron and load.

First, it has been appreciated that broad-band matching of a magnetron to a waveguide and then the waveguide to a cavity, is much simpler than attempting to couple direct into the cavity. Second, and most important, the provision of a certain length of line between magnetron and cavity contributes significantly to providing stable operating conditions for the magnetron (loading of the $\pi - 1$ mode). A further advantage is that the position in which the magnetron is mounted within the equipment is fairly independent of the microwave power delivery requirements. From this one may choose a position that offers the best physical conditions for the magnetron and the most favourable position for high voltage and heater lines. A number of methods of coupling the magnetron to the oven cavity are illustrated in Fig. 4.5.

4.6 Conveyor Belt Ovens

In food factories where food is cooked or partially cooked for refrigeration or deep-freezing, and in cafeterias with a demand greater than 200 meals an hour, economics favour a continuous heating process. Often the microwave power in these installations is as much as 200 kW, but may be as low as 4 kW. Because of the power involved and because food is more or less continuously fed through them, they present different design problems to the batch type cavity ovens.

As the name implies, the microwave cavity in a tunnel oven is in the form of a tunnel through which the food is passed. But many are really conveyorized cavity ovens with inlet and outlet ports. Food passing through the tunnel absorbs almost all the energy, so little escapes. But as a safeguard, chokes can be placed at the inlet and outlet ports. Safety water-loads can be used to absorb the energy in the absence of a load, or a detection device can be used to prevent the magnetron operating.

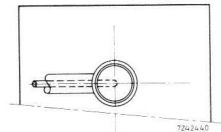
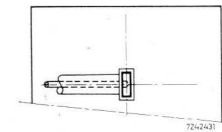
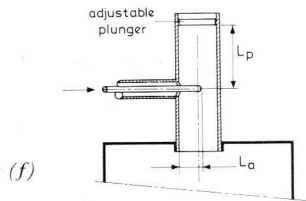
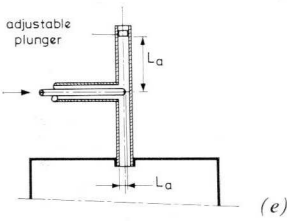
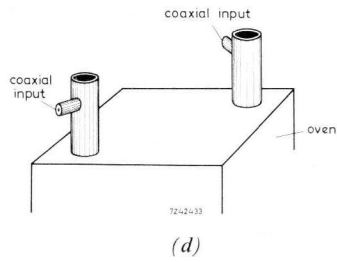
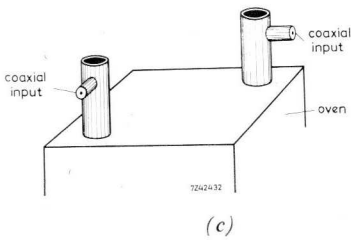
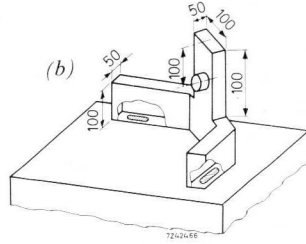
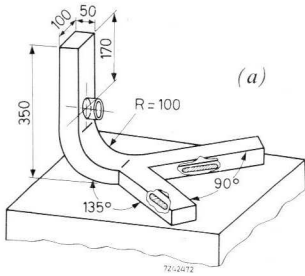
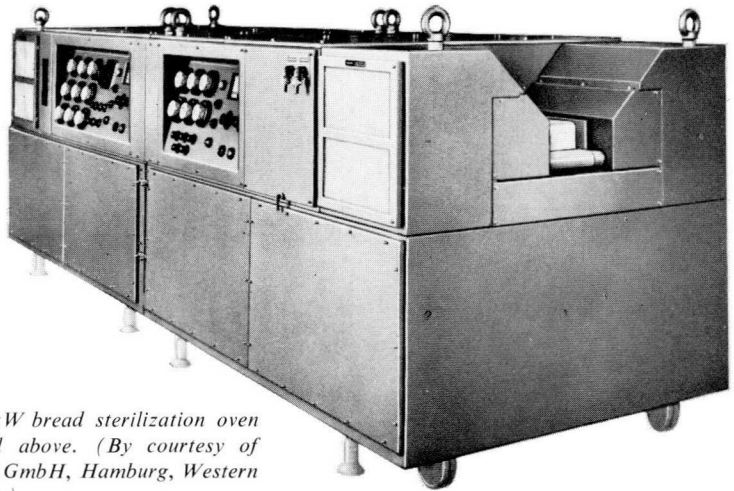

Fig. 4.5. Methods of coupling the oven cavity: (a) and (b) show two ways in which the field is polarised in two normal directions in the x - y plane using a single magnetron; (c) and (d) are two examples using two magnetrons; (e) shows how the field can be polarised in a single direction with a rectangular waveguide transition, whilst (f) shows a circular waveguide transition.

Conveyor ovens usually have entrances and exits about 5 cm high which is sufficient for most deep-frozen complete meals; if microwave filters and chokes are installed near the tunnel openings, bigger apertures may be used.

The oven in the photograph shown below used for sterilizing loaves of bread, requires an entrance and exit height of about 15 cm. The problem of confining the microwave energy to the cavity has been met by setting the cavity at 45° to the line of the conveyor belt. As a result, under normal operating conditions virtually no energy is coupled out, although if the magnetrons were allowed to operate with an empty cavity this might not be so. This condition is guarded against by a pair of microswitches operated by fingers projecting into the cavity. This solution is attractive because it avoids the use of microwave chokes and safety loads, both of which adversely affect efficiency, because they absorb energy.

Another oven is shown opposite in which the ends of the tunnel are closed by hinged plates. As the food enters, the plate is moved aside and springs back into place when the dish has fully entered. This oven, designed by the Swedish firm. Automatic Food Supplies, has also a novel solution for the problem of uneven heating. In most ovens the conveyor belt moves rather slowly through a fairly long tunnel. In this oven the tunnel is short and the belt oscillates back and forth fairly quickly. As a result the oven takes up relatively little floor space.



The 20 kW bread sterilization oven described above. (By courtesy of Herfurth GmbH, Hamburg, Western Germany.)



The 5 kW microwave oven described opposite, in which the moving belt oscillates back and forth. (By courtesy of Automatic Food Supplies Ltd., Växjö, Sweden.)

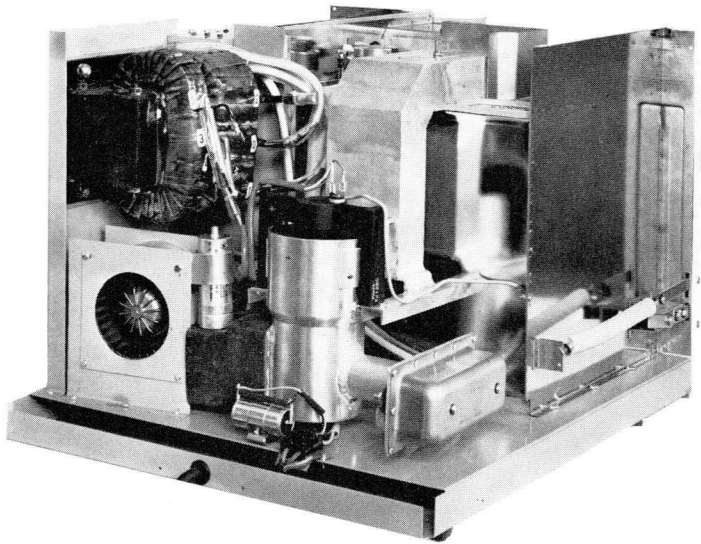
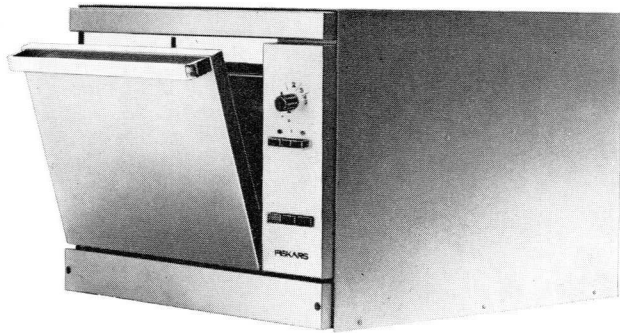

A microwave oven using the YJ1280 magnetron described in this book. The magnetron can be seen in the lower photograph. The oven dimensions are 305 mm wide by 290 mm deep by 190 mm high. (By courtesy of Fiskars Electronics, Helsinki, Finland.)

5 Power Supplies

5.1 Anode Current Stabilization

The low dynamic impedance of the magnetron when it is operating makes it imperative that some form of anode current stabilization is adopted. More so as supply mains are apt to fluctuate by as much as 10%.

As previously described, the threshold voltage which marks the onset of oscillation in the π -mode is set by the magnetic field strength. The stronger the magnetic field, the higher the threshold voltage, so if the strength of the magnetic field is made to vary with the supply voltage, and thus with the anode voltage, a fairly constant anode current can be ensured. Unfortunately this apparently simple solution has several drawbacks, not least that efficient and stable operation for a given magnetron occurs at only one value of magnetic induction. Further, the thermal drift problems associated with electromagnetic circuits make it worthwhile seeking some other form of anode current stabilization.

Basically, the problem is to limit changes of magnetron output power to around $\pm 10\%$ or better (depending on the application), whilst maintaining a good power factor. Two systems using variable series impedance devices seem to offer good solutions; one employs a saturable reactor, the other a circuit that is resonant at approximately mains frequency.

Before discussing these two in more detail it is as well to survey what approaches are available.

5.1.1 RESISTIVE CONTROL

This is the simplest form of control and by far the least effective and most uneconomical as regards running costs.

Generally, resistors are switched in and out of circuit as the supply voltage rises and falls. It is clear that the circuit can only be resistance free when the supply voltage is lowest (i.e. -10%), so about 10% of input power must be dissipated as heat when the supply voltage is nominal, and about 20% when it is at $+10\%$. This, for a 2 kW magnetron, is about 800 W.

If relays are used to switch the resistors in and out, somewhat arduous conditions are set for the contacts. Thyristors may be used instead, but the lack of economy in power remains.

5.1.2 SATURABLE REACTOR CONTROL

Saturable reactors are fairly heavy and bulky, and except in comparison with complex control systems, rather expensive. They are, however, reliable and afford a ready means of adjusting output power for differing load conditions. Whilst power factor ($\cos \phi$) is not good, it is not bad enough to rule out such a method where the other drawbacks are not disadvantageous.

5.1.3 THYRISTOR PHASE CONTROL

Thyristors provide an inexpensive, reliable, and simple replacement for thyatrons in phase control circuits. These systems control the point at which current flow commences in each half cycle; the earlier the firing point, the greater the effective current; the later the firing point, the lower the effective current. One likely difficulty with such circuits is a result of the high efficiency of thyristors as switches. This gives a fast leading edge to the current pulses with the consequent generation of harmonics. A further point is that when used for high powers, phase control systems can cause sufficient disturbance to the supply waveform to incur the disapproval of Supply Authorities. One problem with such systems is the variable peak current that occurs with mains fluctuations.

Phase control systems are not particularly cheap, but they occupy little space and can provide very effective stabilisation of the mean anode current.

5.1.4 THYRISTOR CHOPPER CIRCUITS

Thyristors can be used as very high speed choppers, effectively converting the 50 Hz mains supply to some higher frequency, preferably above audio range because with the high powers involved considerable audible noise could otherwise be generated. Mean anode current can be controlled by variations of the mark-to-space ratio.

One major advantage of high frequencies is that they permit the use of a Ferroxdure transformer with a consequent saving in bulk and weight.

Chopper circuits have no adverse effect on supply waveform, so do not suffer from the same objections as phase control circuits.

5.1.5 VARIABLE IMPEDANCE CIRCUITS

If the impedance of the supply source is made to vary with current, a substantially constant output current can be ensured. Several circuits are based on this approach; all are either series or parallel resonant circuits in the primary or secondary circuits of the high voltage transformers. These circuits have the joint advantage of cheapness, effectiveness, reliability and a good power factor, combined with smaller size and lower weight than the saturable reactor systems.

5.2 Saturable Core Reactors

Saturable core reactors are variable impedance devices in which the controlling influence is a small direct current. Fig. 5.1 shows the general arrangement; here an a.c. winding is split into two parts that are wound in anti-phase on separate legs of the iron core to avoid any transformer action. Two d.c. windings also wound in opposition, are accommodated on the third leg of the core. One is a pre-magnetising winding that sets the point on the BH curve of the core at which the reactor will normally operate; the other senses changes in anode current (or line current) and, as the anode current tends to increase, produces a flux in opposition to that of the other winding, so moving the magnetic working point towards zero pre-magnetisation. This increases the inductance presented to the

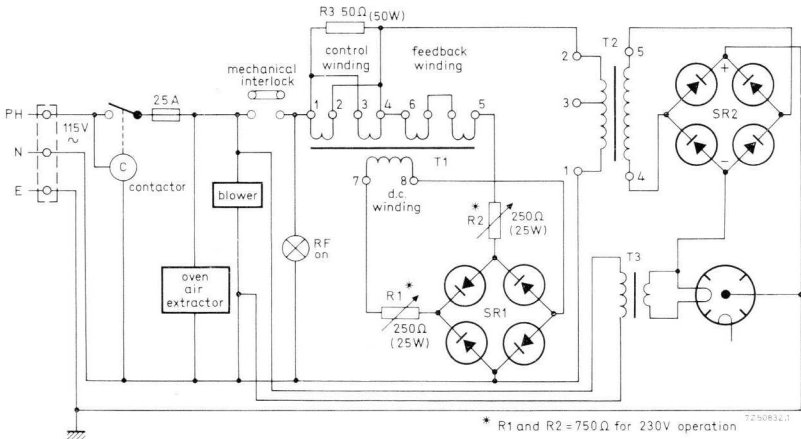

Fig. 5.1. General arrangement of magnetron power supply using a saturable core reactor.

a.c. winding and also the voltage drop across it and thus opposes the tendency for the anode current to increase. When the anode current tends to decrease, the opposite reaction occurs and the working point is moved nearer saturation and the voltage drop across the reactor decreases. In effect, a fairly constant anode voltage is presented to the magnetron.

Design of the high tension transformer must take account of the presence of the saturable reactor, and with so much inductance already in the circuit should aim for low leakage reactance to prevent further deterioration of the power factor ($\cos \phi$).

5.3 Resonant Circuits

Apart from the regulation characteristics, other desirable features of a power supply are a form factor close to 1.1 and $\cos \phi$ near unity. In these respects, the power supplies previously described are not so good.

The regulation factor depends primarily on the variation with current of the impedance of an inductance. With a series resonant circuit the effect can be demonstrated by reference to Fig. 5.2. In Fig. 5.2(c), OA represents the voltage across the load (presenting a constant impedance), AB the voltage across the leakage inductance (leading 90°), BC the voltage across the capacitor (lagging 90°), and OC the applied voltage. If the supply voltage is assumed to increase by 10% as shown by OC' in Fig. 5.2(d), and the voltage across the load kept constant, the increased voltage across the capacitor $B'C'$ must be countered by a decreased voltage across the leakage inductance AB' .

The current in such a circuit is not only related to the frequency of the supply but also to the resonance frequency of circuit itself. This leads to the interesting situation that, provided the correct ratio between the resonance frequency and the mains frequency is chosen, the secondary voltage across the transformer can be less than the required voltage across the magnetron. Other factors are also dependent on this ratio; the size of the capacitor, the form factor, and the power factor.

Experiment has shown the most satisfactory value for the frequency ratio to be 1.2. This combines a form factor of 1.15 with a power factor very close to unity, while ensuring that the capacitor is of a reasonable size and voltage rating.

It should be noted that for correct regulation the frequency ratio must be greater than 1; if it is less, the changes in ωL will magnify the effect of voltage fluctuation.

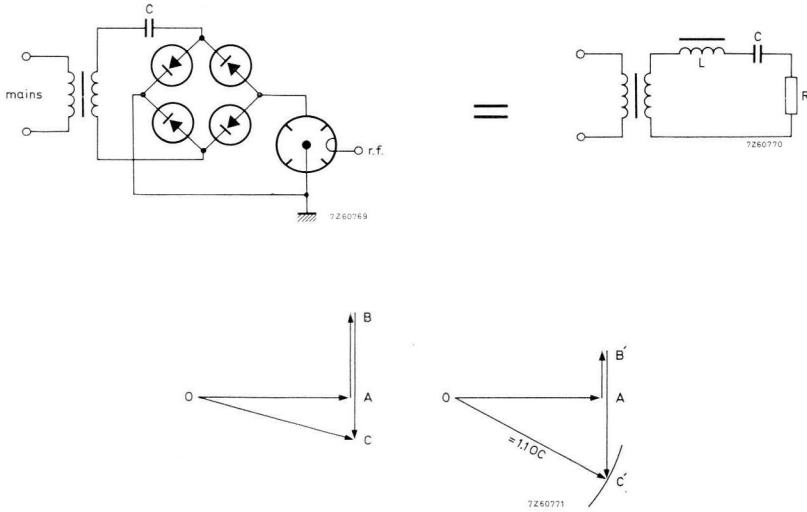

Fig. 5.2. Resonant circuit using capacitor in conjunction with leakage inductance of transformer:

(a) basic circuit; (b) equivalent circuit; (c) OA represents magnetron voltage, OC is supply voltage; (d) supply voltage has risen 10%, anode current is kept constant by sharp drop in inductance.

It is common for the inductive part of the circuit to be combined with the transformer; thus reducing the size, weight, and cost of the supply. The most difficult part of designing this sort of supply is the high voltage transformer which should have a high leakage reactance and a core with a high a.c. permeability and a fairly steep slope at the chosen working point.

Generally, grain-oriented 3% silicon steel is most suitable for the core, with the primary and secondary windings on separate legs. A magnetic shunt is interposed to obtain the desired leakage reactance and can be used as an adjustment to compensate the tolerances of production components.

This type of circuit yields an anode voltage waveform squared off with a fairly high mark-to-space ratio. Although the ratio of peak to mean anode current is fairly low, it remains almost constant regardless of supply fluctuations.

5.4 Heater Supplies

Heater transformers often have to supply two voltages; warm-up (standby), and operational. The warm-up voltage is the highest and is switched on to a cold heater, which may lead to excessive surge current flowing unless special precautions are taken. By giving the heater transformer a high leakage reactance, its short-circuit output current can be kept below the specified surge current of the magnetron even with the supply voltage at its maximum (usually +10%). Alternatively, a resistor or choke to limit surge current can be switched out of circuit a second or two after the heater supply has been switched on.

Operational heater voltage is lower than the warm-up value because back bombardment contributes considerably to cathode temperature. If the magnetron is to be operated at more than one power level, the heater voltage must be adjusted accordingly.

5.5 Practical Power Supply Units

Two practical power supply units for microwave appliances are described here. One is designed for use with the 1/1.5 kW continuous wave magnetron YJ1280; the second for the 2/2.5 kW type YJ1162. Basically, the circuits are identical; the only important difference being that the 4 kW power supply required for the YJ1162 is designed for operation from a two-phase supply voltage of 380 V due to the heavier mains load, so consequently the HT transformer is different.

5.5.1 POWER SUPPLY UNIT FOR THE 1 kW MAGNETRON YJ1280

The circuit of the 2 kW power supply unit for the YJ1280 is shown in Fig. 5.3.

Two transformers are employed; one for the HT, and another for the heater supply. As soon as the mains is applied to the circuit, a heater voltage of 5 V is available for the magnetron. This maintains the magnetron in the "standby" condition. The duration of oven heating is controlled by a time switch which operates the "ON" relay, causing the mains voltage to be applied to the HT transformer and the magnetron heater supply to be reduced to 3.5 V.

If the magnetron was directly connected to the heater transformer secondary, the surge current would be about 98 A, which is in excess of the magnetron ratings. Fourteen NTC resistors in parallel, are connected

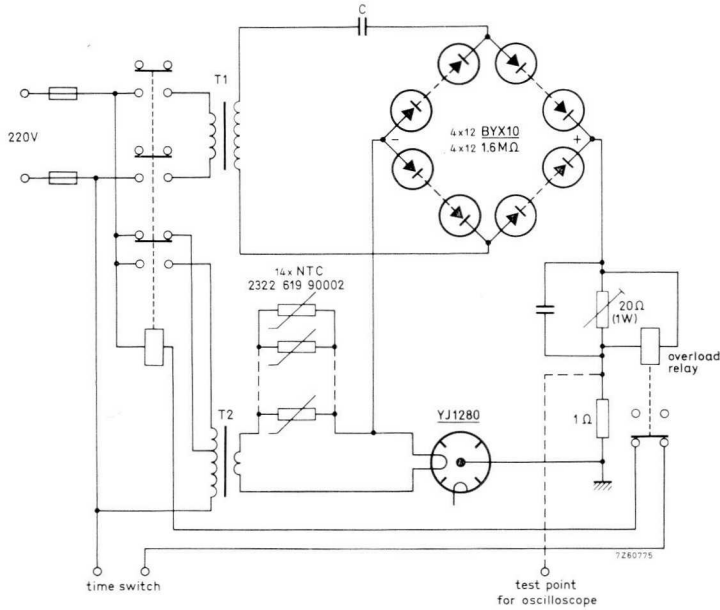

Fig. 5.3. Circuit diagram of power supply unit for 1/1.5 kW magnetron type YJ1280.

in series with the magnetron heater and the heater transformer secondary to limit the surge current in the cold condition to about 55 A. These resistors should be in good thermal contact with each other, so that they have virtually the same operating temperature. One solution is to enclose them in a thermally-insulated container of non-combustible material.

An overload relay is provided to switch off the HT if the magnetron anode current exceeds a pre-determined value. The relay coil is connected across a 20 Ω preset resistor which is in series with the magnetron anode circuit. The setting of this resistor determines the operation of the overload relay. The overload relay contacts are connected in series with the input relay, so that if the overload relay is energised the mains supply to the HT transformer is switched off. The heater supply voltage then reverts from the operating condition of 3.5 V to the standby condition of 5 V.

The Tables 5.1 and 5.2 give the results of measurements made on the heater circuit. Table 5.1 shows the measurements obtained in the standby condition, whilst Table 5.2 represents full operation.

The performance of the HT section of the power supply was determined by connecting instruments in the positions shown in the circuit of Fig. 5.4. A series of measurements were taken, the value of the series capacitance C being reduced in steps, the other parameters being kept constant. The results obtained are given in Table 5.3.

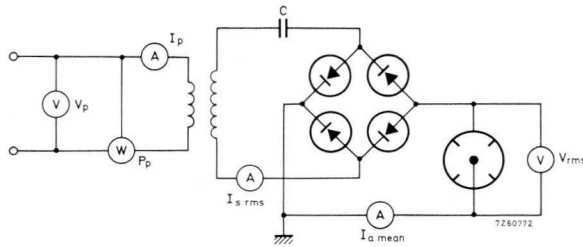

Fig. 5.4. Measurement of performance of HT circuit.

Taking the lowest value of C ($0.192 \mu\text{f}$), the series of measurements was repeated, this time varying the number of turns, N_s , on the secondary winding. Table 5.4 gives the results obtained.

It was finally decided to use a value of $0.208 \mu\text{f}$ for the series capacitance and employ a secondary winding of 5450 turns of 0.45 mm dia. enamelled copper wire provided with a number of taps so that a capacitance of $0.2 \mu\text{f}$ with a 4% tolerance could be used and yet enable the anode current of the magnetron to be set to the specified value of 380 mA . The primary winding was 172 turns of 1.8 mm dia. enamelled copper wire. The core material was Armco M6X grain-oriented laminations (alternative: Manesmann ORSI 111), and the core size $\text{UJ114} \times 0.35 \text{ mm}$ thick DIN 41302.

Using a capacitance of $0.208 \mu\text{f}$ and the secondary winding tapped at 5250 turns, the performance of the HT circuit was measured for different values of mains voltage. The results are given in Table 5.5. The change in magnetron anode current relative to that with a 220 V mains input voltage is given in the last line of the Table, expressed as a percentage.

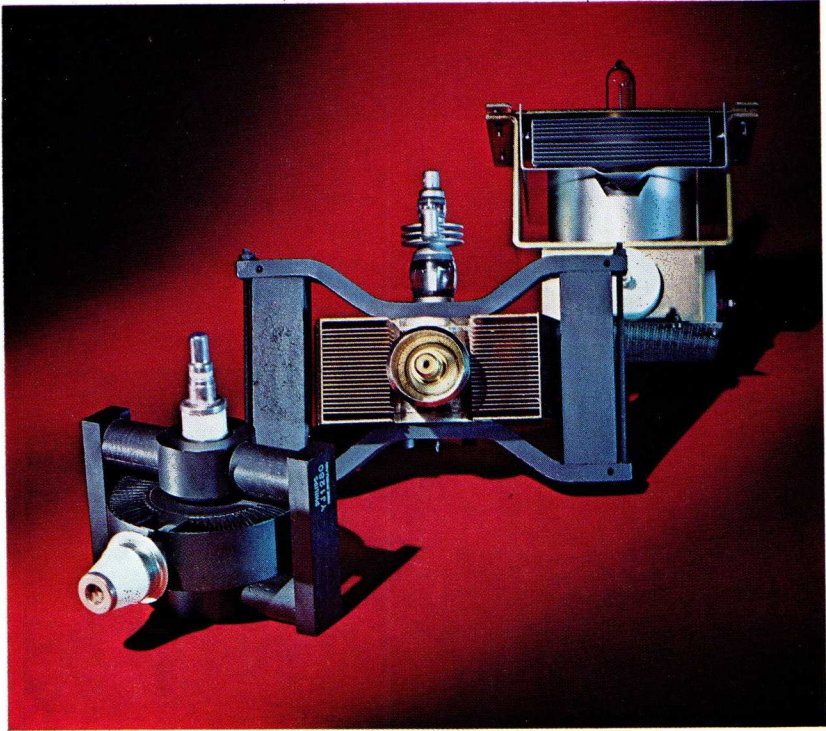

Table 5.1. Heater circuit measurements with magnetron on standby.

V_p	(V)	200	210	220	230	240
I_p	(A)	0.77	0.815	0.865	0.945	1.055
V_s	(V)	4.94	5.16	5.4	5.62	5.86
V_h	(V)	4.46	4.69	4.9	5.14	5.36
V_{NTC}	(V)	0.48	0.47	0.5	0.48	0.4
I_h	(A)	26.9	27.75	28.5	29.3	29.8
P_p	(W)	141.5	154	165	177.5	190
P_s	(W)	132.8	143	154	164.5	175
$\cos \phi_p$		0.918	0.9	0.867	0.816	0.75

Table 5.2. Heater circuit measurements with magnetron operating.

V_p	(V)	200	210	220	230	240
I_p	(mA)	320	335	354	371	387
P_p	(VA)	64.0	70.35	77.88	85.33	92.88
V_s	(V)	3.56	3.73	4	4.18	4.35
V_h	(V)	3.24	3.4	3.59	3.73	3.9
V_{NTC}	(V)	0.32	0.33	0.41	0.45	0.45
P_s	(W)	57.31	61.55	71.6	76.08	82.65

Table 5.3. HT circuit measurements for different values of C.

V_p	(V)	220	220	220	
C	(μ F)	0.228	0.208	0.192	
N_p		170	170	170	
N_s		5250	5250	5250	rms values
I_p	(A)	11.8	10.7	9.9	
P_{VA}	(kVA)	2.6	2.36	2.18	
P_w	(kW)	2.54	2.3	2.1	rms values
V_a	(kV)	5.74	5.72	5.73	mean values
I_a	(mA)	405	370	340	
$\cos \phi_p$		0.978	0.972	0.964	(measured with water load)
P_{rf}	(kW)	1.343	1.216	1.12	

Table 5.4. HT measurements for different values of N_s .

V_p	(V)	220	220	220	220
C	(μ F)	0.192	0.192	0.192	0.192
N_p		175	175	175	175
N_s		4800	5030	5250	5500
I_p	(A)	8.7	9.15	9.65	10.3
P_{VA}	(kVA)	1.914	2.013	2.12	2.268
P_w	(kW)	1.815	1.95	2.06	2.21
V_a	(kV)	5.66	5.69	5.69	5.71
I_a	(mA)	291	314	331	353
$\cos \phi_p$		0.948	0.97	0.972	0.974
P_{rf}	(kW)	0.94	0.992	1.057	1.145

Table 5.5. Variation in performance with change in supply voltage.

V_p	(V)	200	210	220	230	240
I_p	(A)	11.3	11.25	11.2	11.06	11.1
P_{VA}	(kVA)	2.26	2.36	2.46	2.54	2.66
P_w	(kW)	2.23	2.32	2.4	2.45	2.46
V_a	(kV)	5.68	5.09	5.71	5.71	5.7
I_a	(mA)	352	367	378	385	389
$I_{a \max}$	(A)	0.7	0.67	0.69	0.67	0.69
$I_{a \max}/I_a$		1.98	1.9	1.82	1.76	1.77
$\cos \phi$		0.986	0.982	0.974	0.963	0.923
P_{rf}	(kW)			1062		
$I_a/I_a 220V$	(%)	93.1	97	100	101.8	102.9

Fig. 5.5 shows oscillograms of the anode current and anode voltage for various values of mains voltage.

5.5.2 POWER SUPPLY UNIT FOR THE 2 kW MAGNETRON YJ1162

The power supply unit for the 2/2.5 kW magnetron YJ1162 is very similar to that for the YJ1280. However, in view of the higher power, the transformers have been designed for operation from two-phase supply (380 V). The design calculations of capacitance, number of turns etc., were carried out in the same way as for the 2 kW power supply unit.

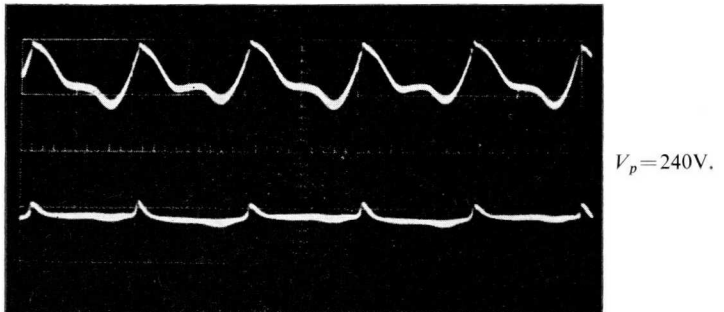
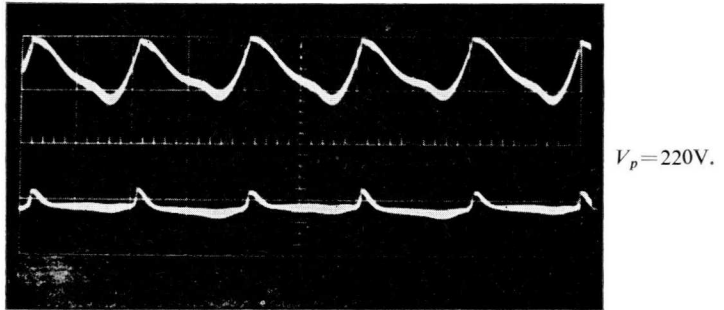
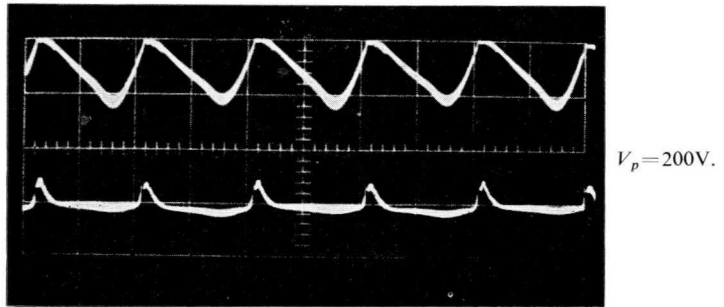

Fig. 5.5. Oscillograms of anode current and voltage. Upper trace is anode current; lower trace is anode voltage. Zero is top of graticule and each rectangle represents 1 cm^2 on graticule; $x = 5 \text{ ms/cm}$, $y_1 = -0.5 \text{ A/cm}$, $y_2 = -2 \text{ kV/cm}$.

Table 5.6 shows the measured values of voltages, currents and powers for a $\pm 10\%$ variation in the supply voltage of 380 V. using an HT transformer with 3430 turns on the secondary, tapped at 3270 turns. The measurements were repeated using the full secondary winding, and the results obtained are given in Table 5.7. The series capacitance had a value of 0.49 μF .

Table 5.6. Variation in performance of 4 kW power supply with change in supply voltage using HT transformer with 3270 turns on secondary.

V_p	(V)	342	361	380	399	418
I_p	(A)	11.32	11.38	11.21	11.0	11.8
P_{VA}	(kVA)	3.87	4.11	4.26	4.39	4.51
P_w	(kW)	3.8	4.05	4.2	4.29	4.32
I_s	(mA)	860	895	925	930	932
V_a ¹⁾	(kV)	4.82	4.83	4.83	4.82	4.81
I_a ²⁾	(mA)	720	764	795	810	819
$I_a \max$	(A)	1.25	1.25	1.3	1.3	1.35 ³⁾
$I_a \max/I_a$		1.73	1.64	1.64	1.6	1.65
$\cos \phi$		0.981	0.986	0.986	0.977	0.957
P_{rf}	(kW)	1.73		1.894		
$I_a/I_a \text{ 380V}$	(%)	90.5	96.1	100	101.8	103.0

Table 5.7. Variation in performance with change in supply voltage using HT transformer with 3430 turns on secondary.

V_p	(V)	342	361	380	399	418
I_p	(A)	12.6	12.45	12.15	11.7	11.38
P_{VA}	(kVA)	4.31	4.5	4.6	4.67	4.76
P_w	(kW)	4.2	4.42	4.53	4.57	4.55
I_s	(mA)	945	975	985	987	987
V_a	(kV)	4.86	4.85	4.85	4.84	4.82
I_a	(mA)	794	827	848	857	860
$I_a \max$	(A)	1.4	1.38	1.35	1.45 ³⁾	1.62 ³⁾
$I_a \max/I_a$		1.76	1.66	1.59	1.7	1.88
$\cos \phi$		0.975	0.983	0.981	0.979	0.956
P_{rf}	(kW)	1.859		2.04		
$I_a/I_a \text{ 380V}$	(%)	93.6	97.5	100	101.6	101.4

1) Measured with electrostatic voltmeter.

2) Measured with moving coil meter.

3) Value is secondary maximum at higher voltage excursions.

The last line of Table 5.6 shows the value of the magnetron anode current expressed as a percentage of its value at a supply voltage of 380 V. When the mains voltage varies $\pm 10\%$, the variation in anode current is from $+3\%$ to -9.5% . In Table 5.7, however, a $\pm 10\%$ variation in mains supply voltage causes the anode current to vary between only $+1.4\%$ and -6.4% .

Comparison of these results clearly shows that not only is the r.f. power output greater, but the regulation of the magnetron anode current is much better.

The HT transformer in its final form used 3430 turns of 0.7 mm diameter enamelled copper wire on the secondary winding, and 217 turns of 2.0 mm diameter wire on the primary. The core material was Armco M6X grain-oriented laminations, size $UJ180 \times 0.35$ mm thick DIN 41302.



*A 2 kW microwave oven using the YJ1162 magnetron.
(By courtesy of Saifecs, Milan, Italy).*

6 Cooling and Screening

An operating magnetron has considerable energy concentrated in the small volume of the anode block. For instance, if a magnetron is operating at an output efficiency of 60%, then the remaining 40% of the total input energy is dissipated as heat in the anode block. Because of this, adequate cooling is essential. The anode block may be either air or water cooled according to type and rated output of the magnetron. Provision is made on the anode block for a thermally operated switch to disconnect the anode supply in the event of the block temperature reaching the specified maximum. The cathode and heater terminals of some types of magnetron are fitted with cooling clips over which a stream of cooling air should be directed. The cooling air must not be allowed to impinge on the glass part of the envelope.

6.1 Air Cooling

The photograph on page 19 shows a 2.5 kW air-cooled magnetron. The cooling fins are tapered so that air is guided across the anode block toward the output coupling. Part of the air may be diverted to cool the cathode radiator, or a small additional blower may be used. Blowing is usually preferred to extracting, mainly because fans are more efficient when handling cold and therefore denser air. Adequate provision must be made to vent hot air from the cabinet, either by natural convection or by a ducting system.

The amount of cooling air needed for a specific application can be calculated from the curves supplied in the magnetron data sheets. Typically, the rise in anode temperature and cooling air, per kW output, and also the air pressure drop across a magnetron are shown as functions of air flow. The air-cooling curves of a magnetron type YJ1162 are shown in Fig. 6.1. With the aid of this diagram, an example will be given, assuming a magnetron dissipation of 1.45 kW, which is not unusual for this type. The maximum specified anode block temperature is 125 °C, on which 10 °C will be allowed for the difference between the temperatures at the reference point and the thermo-switch mount. If the air inlet temperature

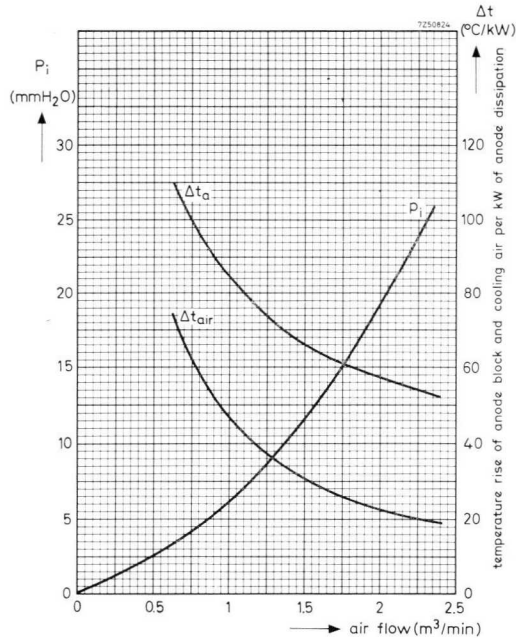

Fig. 6.1. Air cooling curves of a type YJ1162 magnetron.

is 25 °C, the increase (ΔT) of anode temperature will be limited to 90 °C (115°–25°). Therefore the maximum temperature increase allowable per kW of output power will be:

$$\Delta t_a = \frac{1}{1.45} \times 90 = 62.2 \text{ } ^\circ\text{C}.$$

From the curve for t_a an air flow of 1.7 m³/min. is required. A vertical dropped on this point of the curve, shows that the air temperature will increase by approximately 27 °C and that the blower must overcome a pressure drop equivalent to 15 mm of water.

6.2 Water-cooled Anode Block

The YJ1160 magnetron is water-cooled. The magnetron water inlet may be connected directly to the water main, in some cases. This, however,

should only be done if the temporary hardness of the water is less than 12.5° (British*), otherwise a re-circulating system is better.

A schematic diagram of such a system is shown in Fig. 6.2. This system is designed for severe operating conditions in which the ambient temperature is 40 °C with (as a worst case) a v.s.w.r. of 3 in the off-sink region. The magnetron is cooled by water that re-circulates through an air-cooled heat exchanger. It is assumed that with an air inlet temperature of 40 °C (ambient), the water is cooled to 50 °C. If then, a conservative upper water temperature of 70 °C is set (to avoid the formation of vapour bubbles) an anode dissipation of 2.5 kW requires a flow of 1.8 litres of water per min. To achieve a temperature drop of 20 °C, 7.7 cu.m. per min. of air must pass through the heat exchanger for an average air outlet temperature of 55 °C.

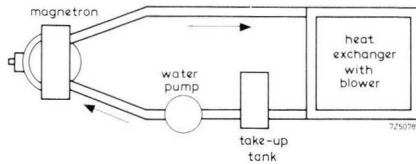

Fig. 6.2. Recirculating system for a water-cooled magnetron.

The heat exchanger must permit a proper flow of heat from water to air, whilst offering the least resistance to the flow of both water and air. At the same time the heat exchanger should be compact so that the cooling system is small and flat. With the system described an air-flow across the heat exchanger of 14 m³/min. can be obtained with a blade diameter of 200 mm. The water pump shown is capable of pumping 4 litres/min. against a head of 2 metres.

It is worth noting that a closed circulating system that is cooled by air at ambient temperature, will always be above ambient while operating, and that no condensation will occur in a humid environment. Care in the layout of the cooling pipes on the inlet side of the magnetron is needed

* 12.5° (British) = 10° (German) = 18° (French) = 10.5° (U.S.A.)

if a mains water supply is used for cooling, since the inlet temperature is likely to be lower than ambient and condensation can occur. If an installation remains unused for some time, protection against freezing may also be necessary. Curves for a water-cooled magnetron are shown in Fig. 6.3.

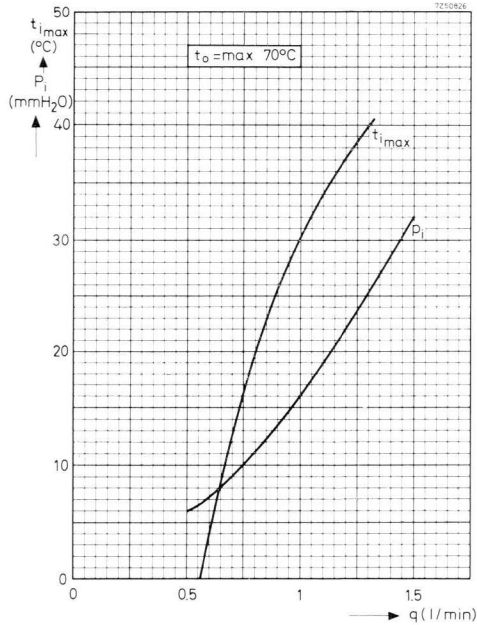

Fig. 6.3. Cooling curves for a water-cooled magnetron type YJ1160.

These are computed for a maximum outlet temperature of 70 °C. It is only necessary, therefore, to ascertain the water inlet temperature for the required volume and pressure drop to be obtained directly. For example, an inlet temperature of 30 °C will need 1.0 litre per minute against a pressure drop of 16 mm of water.

6.3 R.F. Interference

Unless adequate measures have been taken it is possible that r.f. interference may occur at frequencies outside the allocated band after switching on the anode supply, especially during the very short period before oscillation has stabilised in the π -mode. The cathode/heater structure and its associated leads are the only likely source of interference, assuming that the cavity and cavity door are well designed. If the cabinet that houses the equipment has no large holes and if the metal parts make good contact with one another, r.f. leakage should be sufficiently attenuated. If this is not so, a cathode screening-box should be fitted. The design of a suitable screening-box will vary from one magnetron type to another, as the amount of r.f. energy coupled into the heater and cathode depends on the structural design. The effectiveness of a screening-box also depends on the load conditions of the magnetron and the current waveform of the power supply. Moding might, amongst other effects, cause increased r.f. interference.

Screening-boxes usually incorporate filters to screen heater supply leads, but even if the cabinet itself provides sufficient screening for the cathode structure to make a screening-box unnecessary, it is advisable to fit filters in the heater leads. The filters should be adequately screened to prevent r.f. leakage from their components. Should serious r.f. interference problems be encountered, the advice of the magnetron supplier should be sought.



The self-service restaurant on the m.s. Koningin Juliana which operates on the Hook of Holland to Harwich service in the North Sea. Six microwave ovens can be seen in the photograph.

7 Measurements on Prototype

7.1 Cold Measurements

Having decided the dimensions of the cavity (with or without computer assistance) and the desired coupling system, i.e. that system which *should* couple and excite as many of the resonant modes as possible, it is now necessary to carry out tests on the prototype to find the optimum coupling position.

The following factors need to be taken into account:

- a. the matched operating frequency of a typical production magnetron can lie anywhere in the band 2.425 GHz to 2.475 GHz;
- b. the v.s.w.r. seen by a magnetron should be such that at any given frequency it does not exceed the maximum value permitted;
- c. the changes in v.s.w.r. seen by the magnetron, caused by the field stirrer as it rotates, must also be within the published limits (the limits allowed depend on the period of the field stirrer);
- d. the impedance of the match seen by the magnetron should preferably lie in, or near, the sink region to give maximum output, efficiency and frequency pulling;
- e. the foregoing conditions must hold for *all* loads likely to be used in the cavity;
- f. unless additional special precautions are taken, the residual cavity losses in the event of no-load operation must be sufficient to prevent moding of the magnetron and arcing at the field stirrer and the door contacts.

It is essential that all the foregoing cavity tests are carried out at a given coupling position with a given coupling design. It is unlikely that these requirements can all be met at the first attempt and modifications to the launch and its position relative to the cavity must be made until these conditions are met.

Experience has shown that these requirements entail many weeks of tedious and expensive slotted line measurements if the tests are to be carried out properly and may well daunt an intending designer. A typical set-up using slotted line techniques is shown in Fig. 7.1.

A much quicker way of carrying out such measurements – half an hour as compared to a week – and giving a far more reliable result is to use a system employing an automatic phase and amplitude plotter that gives a picture on a Smith Chart of the impedance seen by the magnetron. Details of this equipment are available on request.

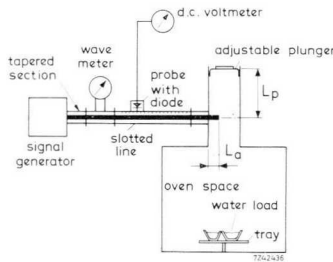

Fig. 7.1. Slotted line measurements for determining the VSWR.

7.2 Hot Measurements

7.2.1 ENERGY DISTRIBUTION

Mention was made of the desirability of exciting the maximum number of modes in the oven cavity to promote a uniform electric field. As field distribution cannot be measured direct without disturbing it, indirect methods must be used. Many have been tried with varying degrees of success. The most satisfactory involves soaking sheets of cardboard in cobalt chloride solution and arranging them in layers within the cavity. After brief exposure to the microwave field, the sheets will dry and the colour of the cardboard will change from red to blue. Irregularities in heat distribution will show up as variations in the colour of the cardboard. With this method a three-dimensional picture of the energy distribution can be built up. In another method, a sheet of lossy material covered with wax is placed in the cavity. Exposure to the microwave field melts the wax in areas of high intensity but not in areas of low inten-

sity. For a complete picture of the energy distribution at the shelf, the test should be repeated at various power levels, and for differing periods at a fixed power level. Heat-sensitive copying paper can also be used, as can sheets of dielectric material covered with wax and sprinkled with sand. Where the wax melts the sand will sink in, so that a pattern of melted and unmelted area is produced.

Where a quantitative method is required, small dishes of water can be located in holes drilled in a perspex sheet. If the dishes contain identical quantities of water, the temperature increase of each will be a measure of the energy at that point. The temperatures must be read quickly as cooling will start as soon as the oven is switched off. It is an advantage to have a jig (Fig. 7.2) that holds the requisite number of maximum-indicating thermometers ready for immediate insertion into the dishes. Another way of measuring the temperature is to use thermo-couples fixed to a jig. When the thermo-couples are put into the dishes, a device rapidly scans the thermo-couples and plots the temperature readings on a chart. The final check should be to use the various foodstuffs that are likely to be heated and to measure by a thermo-couple probe the actual temperatures in various parts of the food.

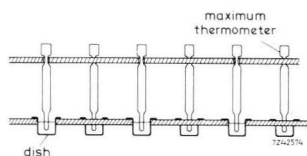

Fig. 7.2. Jig fitted with thermometers for measuring energy distribution.

7.2.2 HEATING EFFICIENCY

If a measured quantity of water is heated in a microwave oven for a pre-determined time, the power absorbed is given by:

$$P = \frac{q \times \Delta t}{14.4 \times T} \text{ watts}$$

where q = quantity of water (cm^3);

Δt = temperature rise of water ($^{\circ}\text{C}$);

T = heating time (min).

Thus the power per minute is

$$P = \frac{q \times \Delta t}{14.4} \text{ watts.}$$

The vessel holding the water should be non-metallic and its walls should be as thin as possible to reduce the error arising from the dish heating by conduction, and from actual energy losses in its walls. If the vessel is likely to affect the accuracy of measurement, its water equivalent must be added to the water volume. Although this procedure should lead to an oven of efficient design, other points should also be considered. The position of the food in the cavity may have a marked effect on the field distribution, particularly in the smaller cavities associated with hot-dog vending machines. In this instance it may help if the way in which the hot-dog falls into the oven is limited to the one that gives the best field distribution.

If the design of the oven permits operation with an empty cavity and safeguards against moding are insufficient, means must be provided to limit the v.s.w.r. under these circumstances, either by provision of a water load or a lossy tray, or some device that switches off the h.t. in such an event.

7.2.3 STRAY MAGNETIC FIELDS

Another important item for checking in the prototype stage is the effect of stray magnetic fields from transformers and chokes; these should not be allowed to affect the magnetic field of the magnetron. The best way to test the effects of nearby transformers is to mount a dummy magnetron (magnets and pole pieces only) in the working position, while the power supplies are used to operate another magnetron mounted well away from the cavity. The change in magnetic flux of the dummy when the magnetron is switched on can then be measured with a fluxmeter.

7.3 Power Supply Measurements

To ensure that the magnetron is being operated within the published limits the following measurements are necessary:

- a. instantaneous heater surge current;
- b. heater operating voltage;
- c. peak and mean values of anode current.

(a) *Heater Surge Current*: This may be conveniently observed on an oscilloscope connected as shown in Fig. 7.3(a). Surge current is maximum when the heater is cold (at least half an hour after last operation), repetitive measurement may, therefore, give a false indication. Surge current waveform can be compared with the waveform produced normally as shown in Fig. 7.3(b) to ensure that the absolute limiting value is not exceeded. Allowance should be made for the highest possible mains voltage, and for the highest tolerance on production transformer voltage.

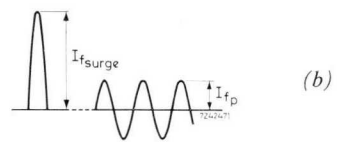
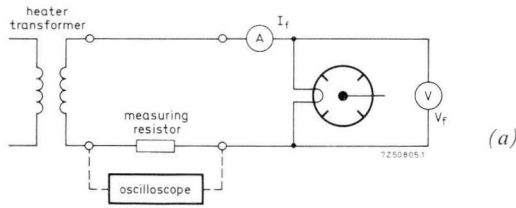

Fig. 7.3. Heater circuit measurements; oscilloscope enables surge current to be compared with normal current.

(b) *Heater Operating Voltage*: Fig. 7.3(a) also shows the connections for a moving coil instrument to measure nominal heater volts. Regard should also be paid to possible fluctuations in mains supply.

(c) *Anode Current*: Provision must be made for measuring anode current during high-power tests. Unless the magnetron is operated from a smoothed d.c. supply (see Chapter 2), both peak and r.m.s. values should be measured. A moving coil instrument will indicate average current directly, but peak current will have to be measured by connecting an oscilloscope or peak-voltage meter across a low-inductance resistor of known value connected in the earthline of the power supply. Alternatively, use may be made of the circuit shown in Fig. 7.4. The direct voltage developed across the capacitor in this circuit is related to the peak value of anode current, 40 μA full-scale deflection corresponding to a peak current of 3 amps. The range may be extended, as shown, to 10 A.

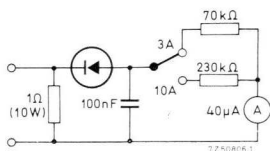

Fig. 7.4. Anode current may be measured by inserting this circuit in the earth line of the power supply.

7.4 Seal Temperatures

The temperature of the magnetron at the point indicated in the data should be measured with the oven operational, and on standby. It may be found that when an oven is switched to standby and the air-cooling is stopped, the temperature of the magnetron may temporarily rise. Provided the maximum temperature limit of the anode block is not exceeded this may not be important, but if the thermal switch (probably set at a slightly lower temperature) should operate, the magnetron cannot be switched back on until the switch has reset.



*A 1 kW microwave oven using the YJ1280 magnetron.
(By courtesy of Dysona Ltd., Great Britain).*

7.5 Stray Leakage

Stray leakage is important from three aspects. First, loss of microwave energy; second, the emission of interference in the communication bands; and third, microwave fields that are unsafe for personnel who operate the appliance. Radio interference is governed by regulations which vary from country to country, but, at present, no safety regulations are in force except in radar installations, which use very high pulse power.

It has been shown by experiments, that the maximum safe field density in the microwave bands is at about 10 mW/cm^2 for all parts of the human body. It is clear that initial designs should aim for *much lower* stray fields to allow for an increase due to dirt or wear during the life of the equipment in view of the possibility of forthcoming legislation.

The mechanism of the door and its seal are probably the most important items as far as stray leakage is concerned. It is *imperative* that the magnetron is switched off by at least two independent systems as soon as the door starts to open.

Designers and manufacturers should ensure that their staff are adequately warned about the possible dangers of microwave energy. They should be particularly warned against looking, or placing their hands, etc., into open waveguides or cavities fed from high energy microwave sources.

7.6 Production Testing

Testing production models is not nearly as rigorous as for the prototype; antenna and mode of coupling are already determined, as well as the impedance transformation elements. All that remains is to confirm by high-power tests that the oven functions safely. Particular attention should be paid to fluctuations in supply mains.

On some occasions it may be necessary to test a microwave oven over an extended period. The arrangements for this are simplified if the load is simulated by a single coil of water-hose through which a continuous stream of water passes via holes in the cavity wall. The power can be calculated from the inlet and outlet temperature of the water and the flow rate of the water.

7.7 Brief Check List

The following check list serves two purposes:

- (a) To assist customers in obtaining optimum life from our magnetrons.
- (b) To enable us to ascertain that, in the event of a claim under warranty, tubes have been used in accordance with their published ratings.

The basic condition to be observed is that even under the most adverse combination of circumstances (worst load, extreme fluctuation of mains voltage, extreme temperature and humidity), the tube is operated within its ratings.

7.7.1 USEFUL OUTPUT POWER

As far as the user is concerned the only output power is that dissipated in the load. This is related to specified tube output power but may or may not correspond with it. It is difficult to simulate all possible loads for a general purpose cavity oven, but a reasonably accurate impression of useful power in the load can be obtained by placing two half-filled 1 litre beakers of water symmetrically and fairly centrally in the cavity.

It can be taken that a temperature rise of 14.4 °C per minute in 1 litre of water corresponds to a dissipated power of 1 kW. The nett load power is determined by the following factors:

- heat capacity and losses in the water containers and in such other dielectric parts of the cavity as trays and supports;
- losses in the microwave circuit itself, mainly r.f. currents in waveguides, cavity, field stirrers;
- operating conditions of the magnetron defined by the load impedance and by the type of power supply used.

Values of nominal and minimum output power for a new tube operated under given conditions are specified in the tube data.

For the YJ1280; *Nominal* output power is 1200 W when operated on an unfiltered, single phase, full-wave rectified anode supply; mean anode current 380 mA, peak anode current 1.1 A, and when delivering energy into a matched load (v.s.w.r. 1.1). *Minimum* output power to be expected (allowing for production spread) for the same conditions is 1130 W. When the output power has fallen to 850 W the tube is considered to have reached the end of its useful life.

When the average load presented to the magnetron is known in terms of v.s.w.r. and phase, the output power can be estimated from the published load diagram.

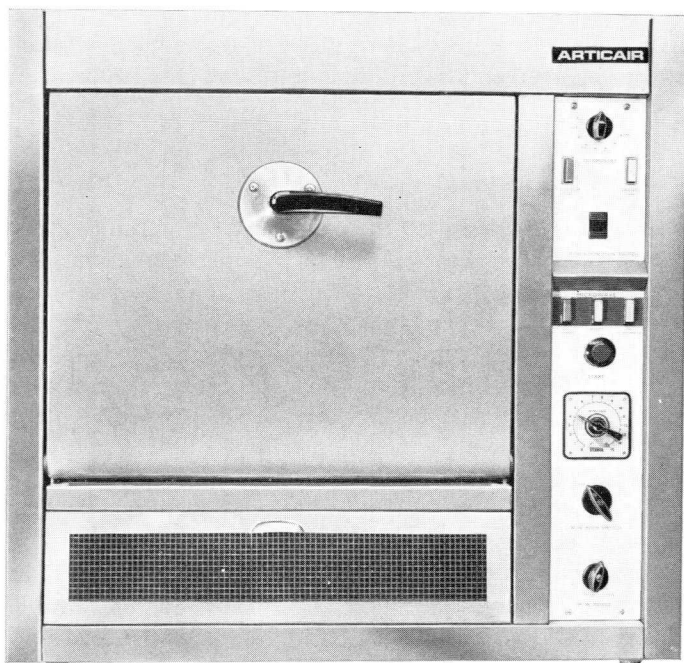

A 2 kW microwave oven with recirculating hot air for prime cooking. This oven uses the YJ1162 magnetron. (By courtesy of Hirst Microwave Ltd., Great Britain.)

Bearing in mind that the frequency of a new tube may lie anywhere in the range 2.425 GHz to 2.475 GHz, it is important that the mismatch is known for the whole of this band. This involves taking measurements at the two extreme frequencies as well as at the nominal: in this way the behaviour of the cavity can be predicted for any production tube.

7.7.2 LOAD IMPEDANCE AND STABILITY

Apart from determining output power, the impedance seen by the magnetron can also have a marked effect on its life. Excessive reflections can lead to overheating and/or instability and shorten a magnetron's life.

Variations in loading should never lead to the rated v.s.w.r. of the magnetron being exceeded. In this respect, it is worth noting that individual tubes may well exceed the published ratings in respect of their ability to withstand high reflections. For this reason it is important that designs be based *on the published data and not on results obtained by testing a single (or even several) tube.*

7.8 Oscilloscope Method of Checking for Moding

If an oscilloscope is used to display the V/I characteristic of an operating magnetron, the onset on moding can be observed quite easily. The circuit of Fig. 7.5(a) shows how to make the x and y connections so that voltage can be shown vertically against a horizontal current display.

The curve obtained from a magnetron that is operating in the π -mode is shown in Fig. 7.5(b). It will be noted that it is quite regular, showing a large increase in current for a small voltage increase once the magnetron has started to oscillate. Moding will be indicated by the appearance of a line (or parts of a line) above the normal curve, or by breaks in the normal curve, as shown overleaf.

Note

The tube manufacturer should be consulted if a power supply is proposed other than those mentioned in the published data, particularly if the voltage and current waveform differ from those of the supplies mentioned, and thus have different conduction angles and different ratios of peak-to-mean anode current.

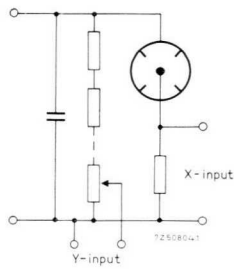

(a)

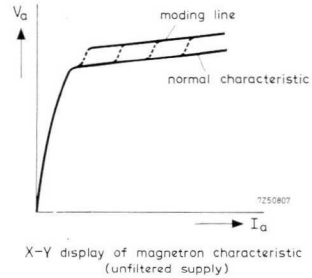

(b)

Fig. 7.5. Oscilloscope method of checking moding. The circuit shown in (a) enables the form of trace shown in (b) to be obtained.

The test should be performed under various load conditions and with field stirrers operating so that the effect of cyclic variations in reflection conditions may be observed. Conveyor-belt ranges should be operated with a variety of characteristic loads because here also the reflection characteristics may be cyclic.

We suggest that these tests should include one with the cavity empty; if the design is a good one moding will not occur. It is worth noting that an empty cavity also represents the worst case condition for the leakage of microwave fields, and that these too should be checked if there is the slightest chance that the installation may be operated (even inadvertently) when empty.

Technology relating to the products described in this publication is shared by the following companies.

Argentina

FAPESA I.y.C.
Melincué 2594
Tel. 50-9941/8155
BUENOS AIRES

Australia

Philips Industries Ltd.
Miniwatt Electronics Division
20, Herbert St.
Tel. 43-2171
ARTARMON, N.S.W.

Austria

WIVEG
Zieglergasse 6
Tel. 93 26 22
A1072 VIENNA

Belgium

M.B.L.E.
80, rue des Deux Gares
Tel. 23 00 00
1070 BRUSSELS

Brazil

IBRAPE S.A.
Av. Paulista 2073-S/Loja
Tel. 278-1111
SAO PAULO

Canada

Philips Electron Devices
116, Vanderhoof Ave.
Tel. 425-5161
TORONTO 17, Ontario

Chile

Philips Chilena S.A.
Av. Santa Maria 0760
Tel. 39-40 01
SANTIAGO

Colombia

SADAPE S.A.
Calle 19, No. 5-51
Tel. 422-175
BOGOTA D.E. 1

Denmark

Miniwatt A/S
Emdrupvej 115A
Tel. (01) 69 16 22
DK-2400 KØBENHAVN NV

Finland

Oy Philips A.B.
Elcoma Division
Kaivokatu 8
Tel. 10 915
HELSINKI 10

France

R.T.C.
La Radiotechnique-Compelec
Avenue Ledru Rollin 130
Tel. 357-69-30
PARIS 11

Germany

VALVO G.m.b.H.
Valvo Haus
Burchardstrasse 19
Tel. (0411) 3296-1
2 HAMBURG 1

Greece

Philips S.A. Hellénique
Elcoma Division
52, Av. Syngrou
Tel. 915.311
ATHENS

Hong Kong

Philips Hong Kong Ltd.
Components Dept.
St. George's Building 21st Fl.
Tel. K-42 82 05
HONG KONG

India

INBELEC Div. of
Philips India Ltd.
Band Box House
254-D, Dr. Annie Besant Road
Tel. 45 33 86, 45 64 20, 45 29 86
Worli, Bombay 18 (WB)

Indonesia

P.T. Philips-Ralin Electronics
Elcoma Division
Djalan Gajah Mada 18
Tel. 44 163
DJAKARTA

Ireland

Philips Electrical (Ireland) Ltd.
Newstead, Clonskeagh
Tel. 69 33 55
DUBLIN 14

Italy

Philips S.p.A.
Sezione Elcoma
Piazza IV Novembre 3
Tel. 69 94
MILANO

Japan

NIHON PHILIPS
32nd Fl., World Trade Center Bldg.
5, 3-chome, Shiba Hamamatsu-cho
Minato-ku
Tel. (435) 5204-5
TOKYO

Mexico

Electrónica S.A. de C.V.
Varsovia No. 36
Tel. 5-33-11-80
MEXICO 6, D.F.

Netherlands

Philips Nederland N.V.
Afd. Elonco
Boschdijk, VB
Tel. (040) 43 33 33
EINDHOVEN

New Zealand

EDAC Ltd.
70-72 Kingsford Smith Street
Tel. 873 159
WELLINGTON

Norway

Electronica A/S
Middelthuisgate 27
Tel. 46 39 70
OSLO 3

Peru

CADESA
Jr. Ilo. No. 216
Appartado 10132
Tel. 27 7317
LIMA

Portugal

Philips Portuguesa S.A.R.L.
Rua Joaquim Antonio de Aguiar 66
Tel. 68 31 21/9
LISBOA

South Africa

EDAC (PTY) Ltd.
South Park Lane
New Doornfontein
Tel. 24/6701-2
JOHANNESBURG

Spain

COPRESA S.A.
Balmes 22
Tel. 232 66 80
BARCELONA 7

Sweden

ELCOMA A.B.
Lidingövägen 60
Tel. 08/67 97 80
10250 STOCKHOLM 27

Switzerland

Philips A.G.
Edenstrasse 20
Tel. 051/44 22 11
CH-8027 ZUERICH

Taiwan

Philips Taiwan Ltd.
Elcoma Division
San Min Building, 3rd Fl.
57-1, Chung Shan N. Road
Section 2
Tel. 553101
TAIPEI

Turkey

Turk Philips Ticaret A.S.
EMET Department
Gümüssuyu Cad. 78-80
Tel. 45.32.50
Beyoğlu, ISTANBUL

United Kingdom

Mullard Ltd.
Mullard House
Torrington Place
Tel. 01-580 6633
LONDON WC1E 7HD

United States**Amperex Electronic Corp.**

Electron Tubes Div.
Tel. 516 WE 1-6200
HICKSVILLE N.Y.
Sem. and Microcircuits Div.
Tel. 401-762-9000
SLATERSVILLE R.I. 02876
Electronic Components Div.
Tel. 516-234-7000
HAUPPAGE N.Y.

Ferroxcube Corp.

(Memory Products)
P.O. Box 359
Tel. (914) 246-2811
SAUGERTIES, N.Y. 12477

Uruguay

Luzilectron S.A.
Rondeau 1567, piso 5
Tel. 9 43 21
MONTEVIDEO

Venezuela

C.A. Philips Venezolana
Elcoma Department
Colinas de Bello Monte
Tel. 72.01.51
CARACAS

