

**Vorläufige technische Daten · Tentative data**



**Zuverlässigkeit**

Der P-Faktor gibt den voraussichtlichen Röhrenausfall in Promille je 1000 Std. an. Er liegt bei ca. 1,5‰ je 1000 Std.

**Reliability**

The factor P indicates how many of 1,000 tubes fail over an operating period of 1,000 hours. The figure is approx. 1.5‰ for each 1,000 hours.



**Lange Lebensdauer**

Für diese Röhre wird eine Lebensdauer von 10000 Std., gemittelt über 100 Röhren, garantiert.

**Long life**

For long-life tubes we guarantee 10,000 hours operation, averaged over 100 tubes.



**Enge Toleranzen**

Bei dieser Röhre sind Streuungen der elektrischen Werte gegenüber Rundfunkröhren eingeengt.

**Tight tolerances**

In these tubes the tolerances of electrical ratings are reduced in comparison with receiving tubes.



**Stoß- und Vibrationsfestigkeit**

Die Röhre kann Schwingungen bis 2,5 g bei 50 Hz längere Zeit sowie Stoßbeschleunigungen bis 500 g kurzzeitig betriebssicher aufnehmen.

**Vibration and shock proof**

The tube withstands accelerations of 2.5 g at 50 c/s for lengthy periods and momentary shocks of 500 g for short periods.



**Zwischenschichtfreie Spezialkathode**

Die Spezialkathode dieser Röhre schließt das Entstehen einer störenden Zwischenschicht selbst dann aus, wenn sie längere Zeit bei eingeschalteter Heizung ohne Stromentnahme betrieben wird.

**Cathode free from interface**

The cathode establishes no interface even in cases where the heated tube is operated without plate current over lengthy periods.

$U_{f1}$ )	<b>6,3 ± 5%</b>	V
$I_f$	<b>1,2 ± 0,08</b>	A

**Meßwerte · Measuring values**

1) Als Pentode · As pentode

$U_a$	<b>100</b>	V
$U_{g2}$	<b>100</b>	V
$R_k$	<b>75</b>	$\Omega$
$I_a$	<b>100<sup>+18</sup><sub>-15</sub></b>	mA
$I_{g2}$	<b>5,2<sup>+1,3</sup><sub>-1,2</sub></b>	mA
S	<b>14 ± 2,5</b>	mA/V
$R_{g2/g1}$	<b>5,6</b>	
$R_i$	<b>5</b>	k $\Omega$
$-I_{g1}$	<b>≤ 1</b>	$\mu$ A
$R_{iL}$	<b>100</b>	$\Omega$
$I_a$ bei $U_{g1} = -35$ V	<b>0,1</b>	mA
$-U_{g1}^{2)}$	<b>&lt; 120</b>	V
bei $I_k = 60$ $\mu$ A		
$U_{asp} = 7$ kV		
$U_{g2} = 190$ V		
$Z_{g1} \leq 1$ k $\Omega$		

2) Als Triode geschaltet · Connected as triode

$U_{ag2}$	<b>100</b>	V
$R_k$	<b>85</b>	$\Omega$
$I_{a+g2}$	<b>100</b>	mA
S	<b>14</b>	mA/V
$\mu$	<b>5,2</b>	
$R_i$	<b>350</b>	$\Omega$
$R_{iL}$	<b>360</b>	$\Omega$

1) Die garantierte Lebensdauer gilt nur, wenn die Heizspannung in den Grenzen von ± 5% gehalten wird (absolute Grenzen).  
The guaranteed life applies only if the filament voltage is kept in the limits ± 5% (absolute limits).

2) Endröhre für Horizontal-Ablenkung: Impulsdauer max. 22% einer Periode, max. 18  $\mu$ s.  
Output tube for horizontal deflection: Pulse duration max. 22% per period, max. 18  $\mu$ s.



**Ende der Lebensdauer, siehe „Meßwerte“ 1)**

Anodenstrom	$I_a$	vom Anfangswert auf 65 mA	gesunken
Steilheit	S	vom Anfangswert auf 9,5 mA/V	gesunken
Negativer Gitterstrom	$-I_g$	vom Anfangswert auf 2 $\mu$ A	gestiegen

**End of the life, see "Measuring values" 1)**

Plate current	$I_a$	reduced from initial value to 65 mA
Mutual conductance	S	reduced from initial value to 9.5 mA/V
Negative grid current	$-I_g$	increased from initial value to 2 $\mu$ A

**Isolationswiderstände · Insulation resistance**bei  $U_f = 6,3$  V

$U_{isol} = 300$ V	Anode gegen alle restlichen Elektroden anode towards remaining electrodes	> 1000 $M\Omega$
$U_{isol} = 300$ V	Gitter 1 gegen alle restlichen Elektroden grid 1 towards remaining electrodes	> 100 $M\Omega$
$U_{f/k} = 100$ V	Faden gegen Kathode filament towards cathode	> 5 $M\Omega$

**Betriebswerte · Typical operation****Optimale Spitzenwerte des Anodenstromes bei Anwendung als Zeilenendröhre.**

Die Kennlinien geben die Werte mittlerer neuer Röhren an. Beim Entwurf der Schaltung für die horizontale Ablenkung ist zu beachten, daß sich infolge Röhrentoleranzen und Veränderungen während der Lebensdauer die angegebenen Werte um 25 % verringern können.

In allen Schaltungen für die horizontale Ablenkung ist  $R_{g2} \geq 1,5$  k $\Omega$  zu wählen. Beim Betrieb der Röhre unterhalb des Knies sollte zum Vermeiden von Barkhausen-Schwingungen der Schirmgitter-Widerstand nicht kleiner als 2,2 k $\Omega$  gewählt werden.

**Optimal values of peak plate current when used as power tube for horizontal deflection.**

Average values of new tubes are indicated by the curves. When developing new circuits for horizontal deflection it is necessary to note that the indicated values, caused by a changing and by tolerances of tubes, may decrease during the life time by 25 %.

For all circuits for horizontal deflection select  $R_{g2} \geq 1.5$  k $\Omega$ . When driving the tube below the knee of anode current vs anode voltage characteristic a higher value for  $R_{g2}$  than 2.2 k $\Omega$  should be chosen to avoid Barkhausen-Kurz-oscillations.



## Betriebswerte · Typical operation

2 Röhren in Gegentakt-B-Betrieb, Dauerton-Aussteuerung

2 tubes push-pull, class B, permanent tone level

$U_a$	<b>250</b>		V
$U_{g2}$	<b>170</b>		V
$R_{g2}^1)$	<b>2 x 0,5</b>		k $\Omega$
$-U_{g1}$	<b>34</b>		V
$I_a$	2 x 12	2 x 94	mA
$I_{g2}$	2 x 1	2 x 14	mA
$R_{aa}$		3	k $\Omega$
$U_{g1\text{eff}}$	0	22	V
N	0	30	W
k		6	%

1) Kapazitive Überbrückung führt zu Überlastung des Schirmgitters und ist deshalb nicht zulässig.  
Capacitive shunting overloads the screen grid and is therefore inadmissible.

## Absolute Grenzwerte

Absolute maximum ratings

$U_{a0}$	<b>650</b>	V
$U_a$	<b>400</b>	V
$U_{asp}^1)$	<b>7</b>	kV
$-U_{asp}^1)$	<b>1,5</b>	kV
$N_a$	<b>20</b>	W
$N_a + N_{g2}$	<b>22</b>	W
$U_{g20}$	<b>650</b>	V
$U_{g2}$	<b>300</b>	V
$N_{g2}^2)$	<b>5,5</b>	W
$-U_{g1sp}^1)$	<b>1</b>	kV
$I_k$	<b>220</b>	mA
$I_{ksp}^4)$	<b>1,2</b>	A
$t_{av}$	<b>10</b>	ms
$R_{g1}^3)$	<b>0,5</b>	M $\Omega$
$U_{f/k}$	<b>250</b>	V
$U_{f/k+}$	<b>250</b>	V
$U_{f/k-}$	<b>200</b>	V
$R_{f/k}$	<b>20</b>	k $\Omega$
$t_{Kolben}$	<b>240</b>	°C

## Kapazitäten · Capacitances

$C_e$	<b>19 ± 1,5</b>	pF
$C_a$	<b>9 ± 1</b>	pF
$C_{g1/a}$	<b>&lt; 1,1</b>	pF

1) Als Endröhre für die horizontale Ablenkung bei Impulsdauer max. 22% einer Periode,  $t_{\text{max}} = 18 \mu\text{s}$ .

As power tube for horizontal deflection at pulse duration max. 22% per period,  $t_{\text{max}} = 18 \mu\text{s}$ .

2) Während der Anheizzeit der Boosterdiode  $N_{g2 \text{ max}} = 7 \text{ W}$ .

During booster diode heating-up period  $N_{g2 \text{ max}} = 7 \text{ W}$ .

3) Als Endröhre für die horizontale Ablenkung unter Verwendung von Stabilisierungsschaltungen mit Regelung über das Steuergitter ist  $R_{g1} = \text{max. } 2,2 \text{ M}\Omega$ .

$R_{g1}$  should be limited to 2.2 M $\Omega$  when DC-control-voltage is applied to grid No.1 for stabilizing purposes.

4) max. 10 ms.

Sockelschaltbild  
Base connection

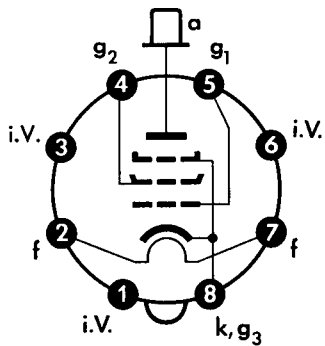

Oktal

Freie Stifte bzw. freie Fassungskontakte  
dürfen nicht als Stützpunkte für Schalt-  
mittel benutzt werden.

Free pins not to be connected externally.

max. Abmessungen  
max. dimensions

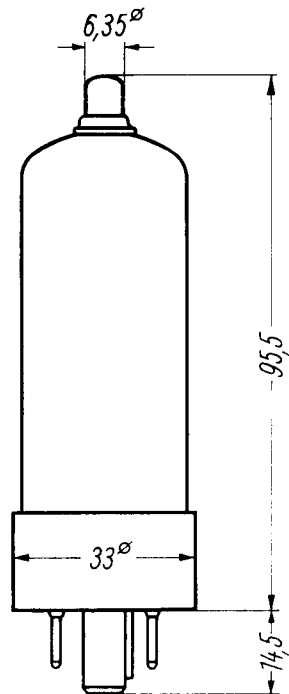

Gewicht · Weight  
max. 40 g

Die Anodenanschlußkappe ist mit  
Nennmaß angegeben.

Nominal measurement of anode  
clip is given.

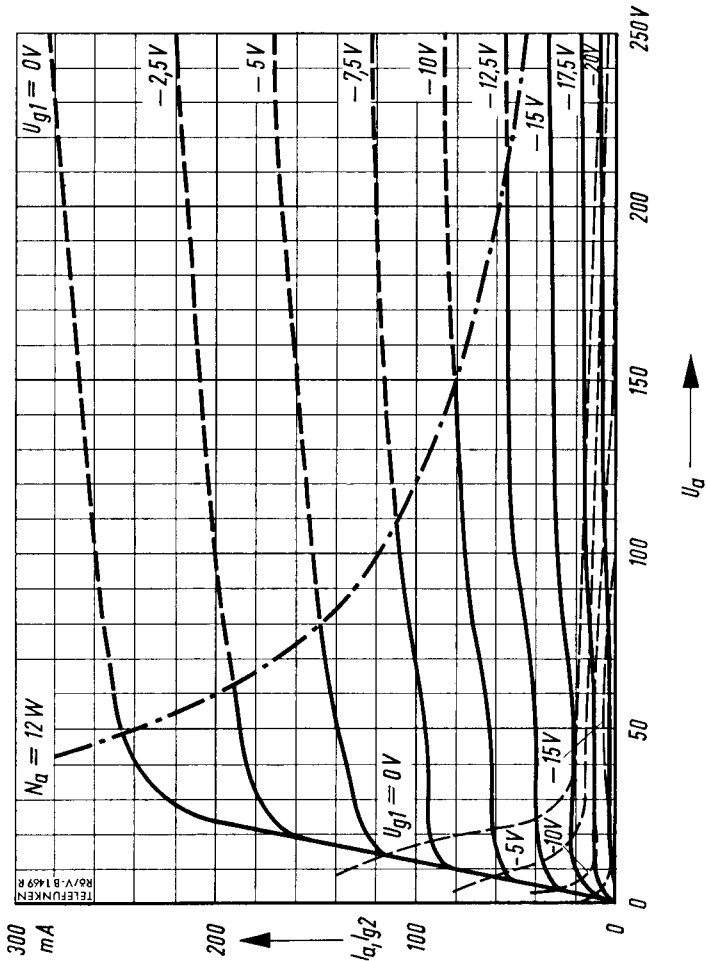

$I_a, I_{g2} = f(U_d)$   
 $U_{g2} = 100 V$   
 $U_{g1} = \text{Parameter}$

—  $I_a$     - - - -  $I_{g2}$

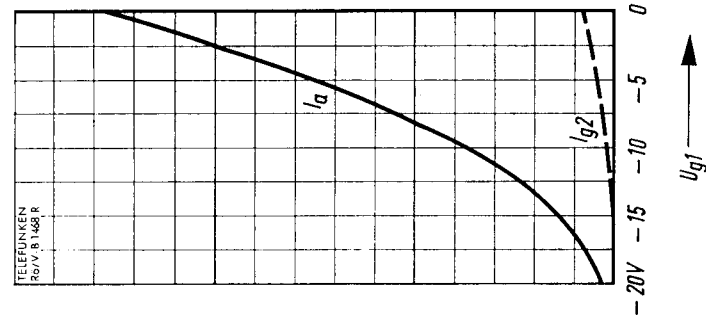

$I_a, I_{g2} = f(U_{g1})$   
 $U_a = U_{g2} = 100 V$



# TELEFUNKEN

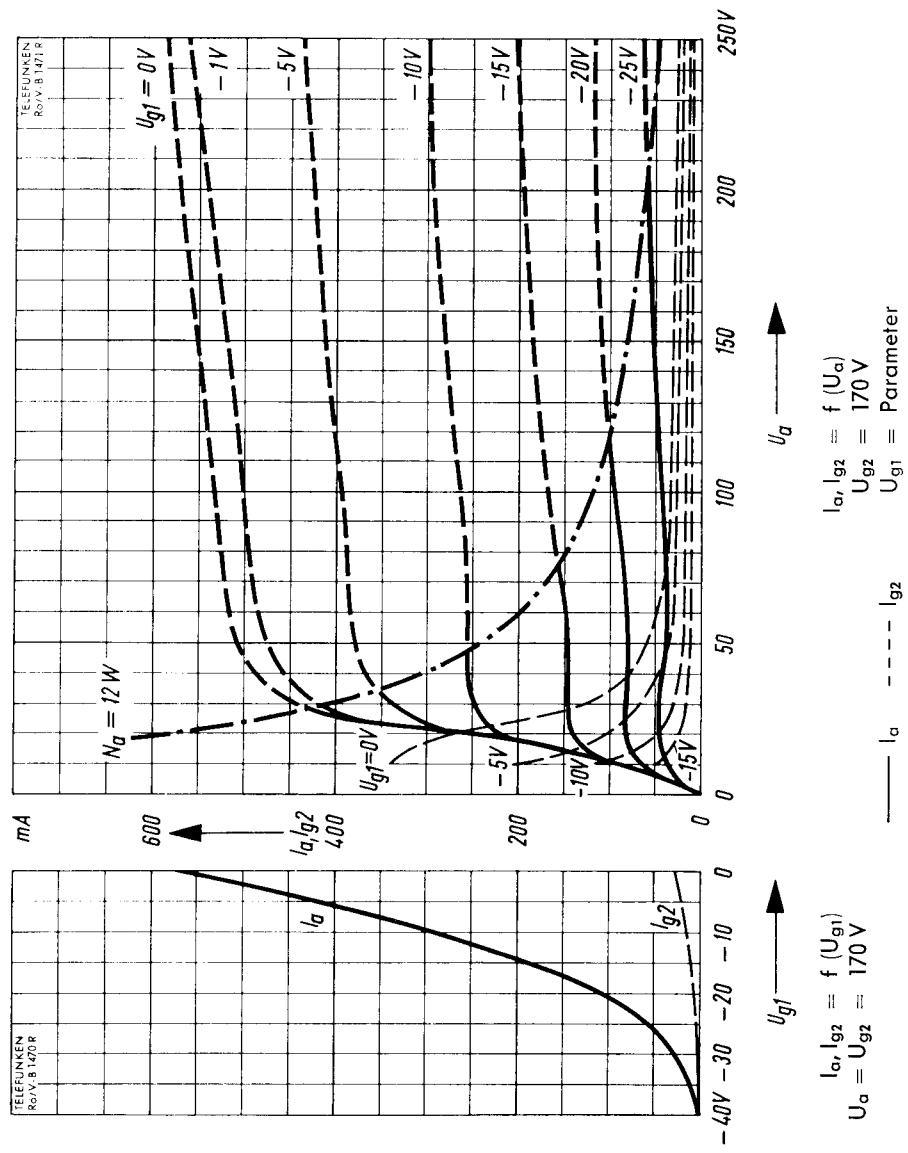

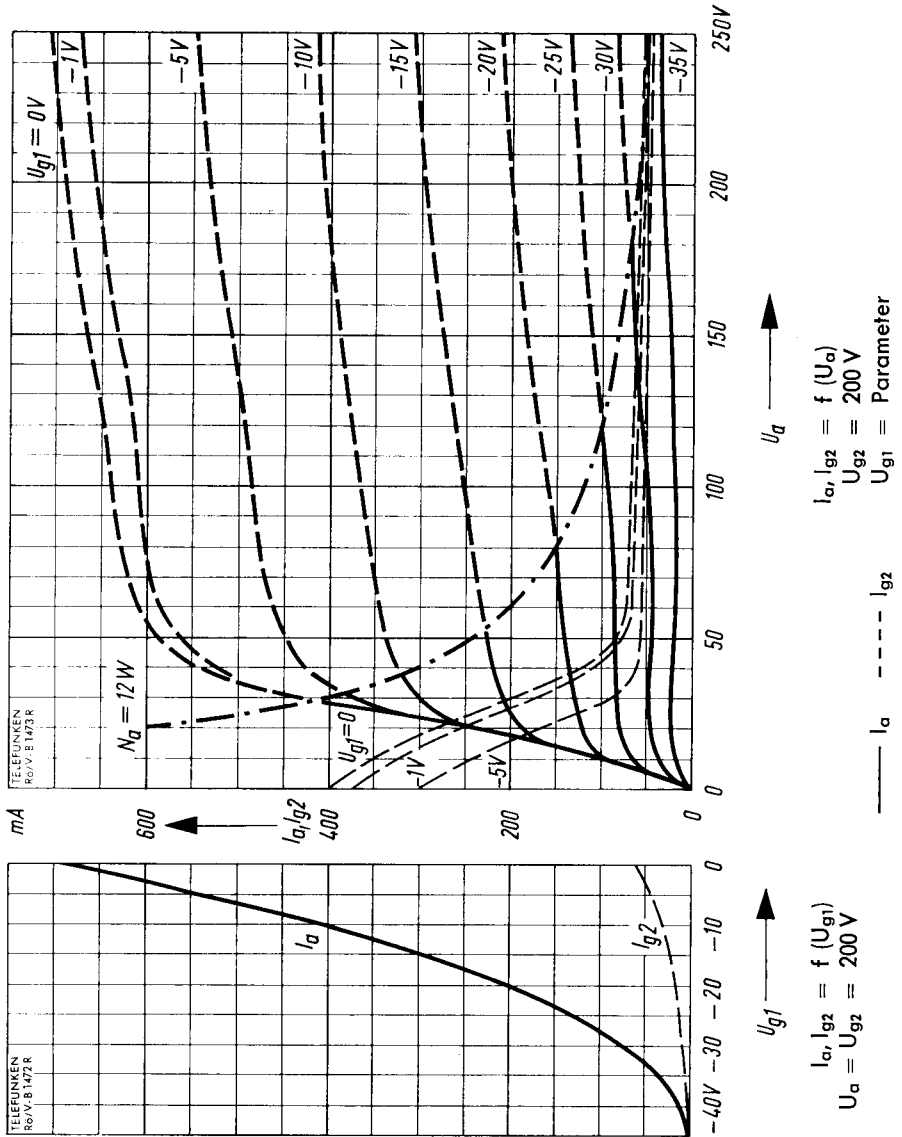

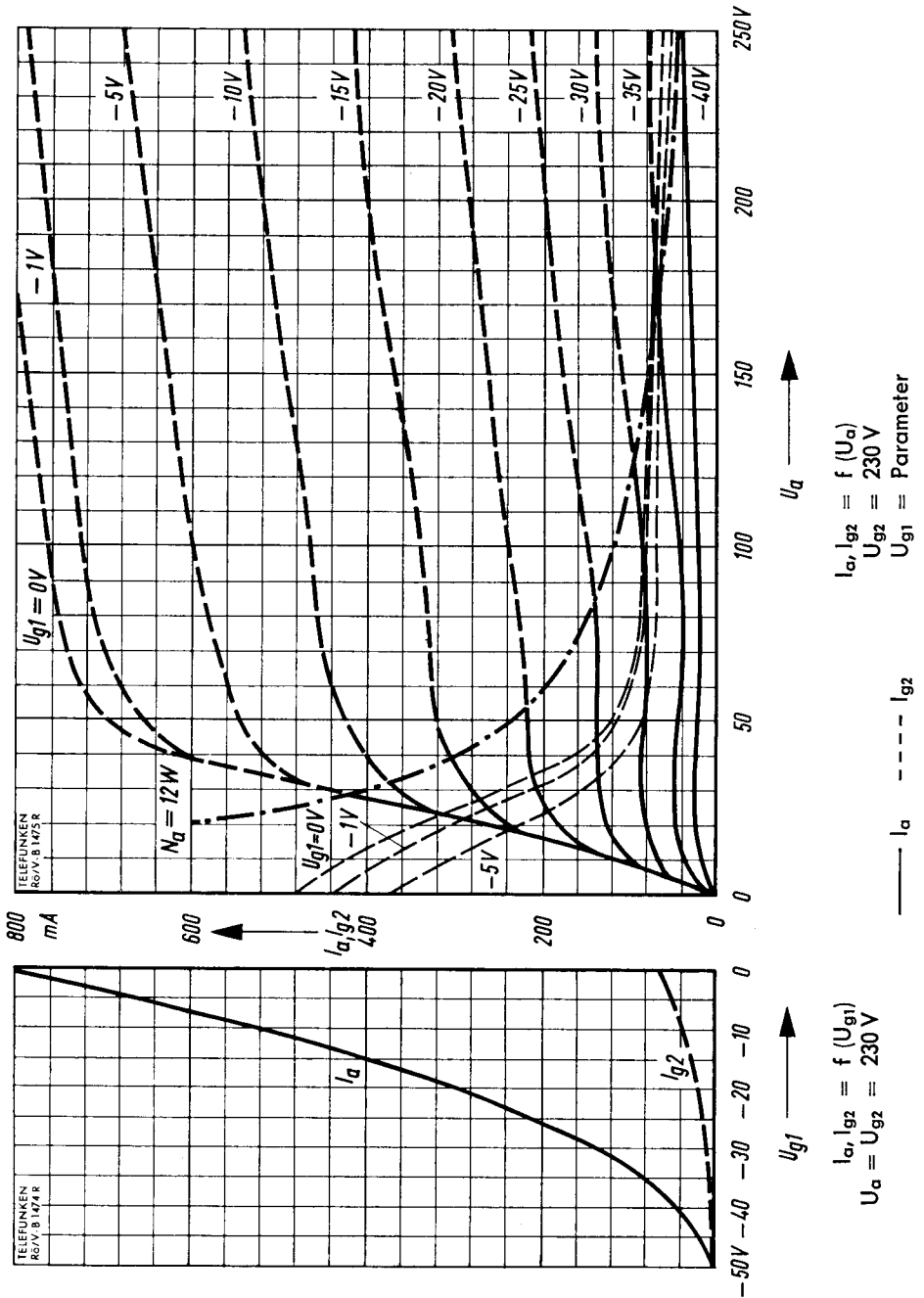



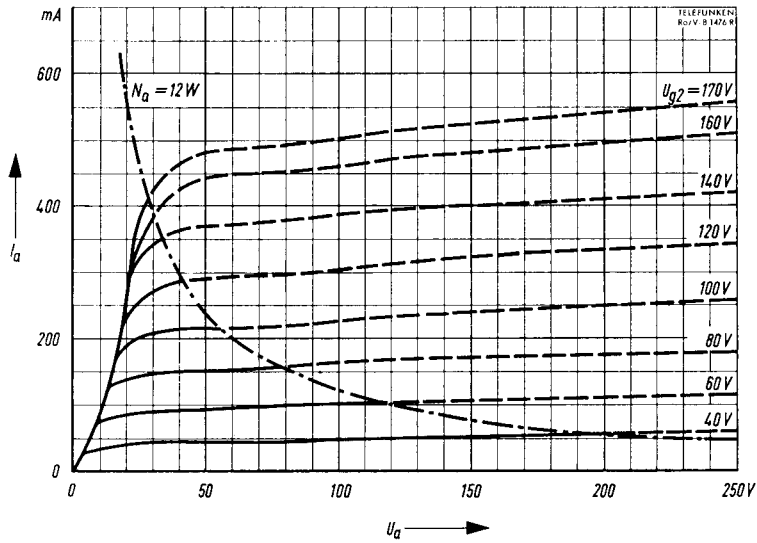

$I_a = f(U_a)$   
 $U_{g2} = \text{Parameter}$   
 $U_{g1} = -1V$

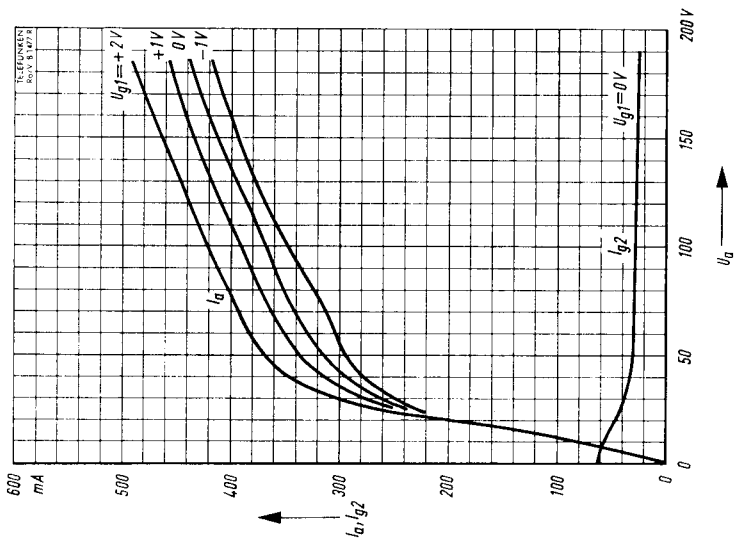

$I_a, I_{g2} = f(U_a)$   
 $U_{bg2} = 190V$   
 $R_{g2} = 2,2 k\Omega$   
 $U_{g1} = \text{Parameter}$

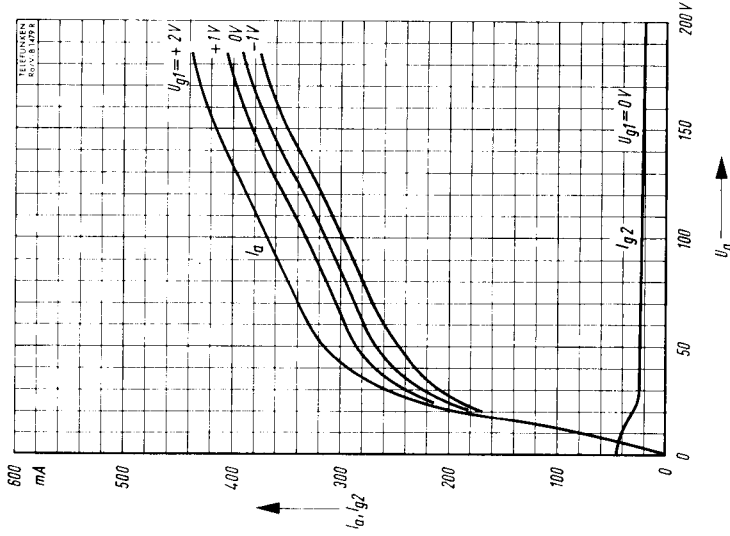

$I_{c1}, I_{g2} = f(U_{g1})$   
 $U_{bg2} = 190 V$   
 $R_{g2} = 3,3 k\Omega$   
 $U_{g1} = \text{Parameter}$

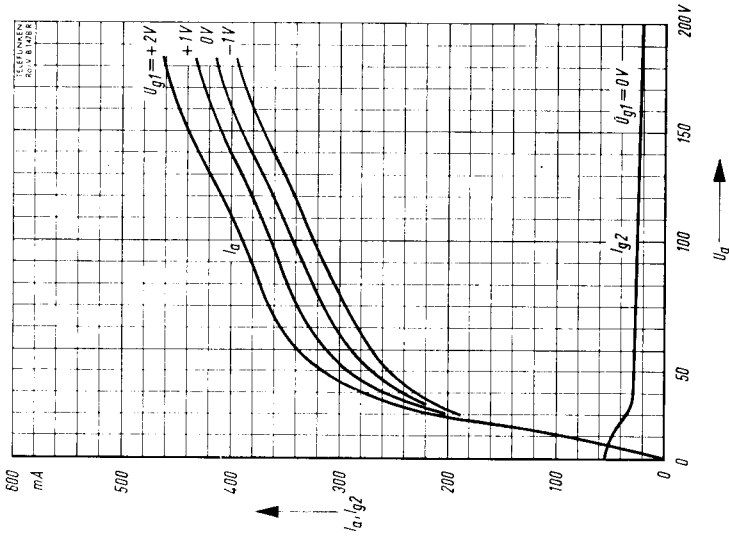

$I_{c1}, I_{g2} = f(U_{g1})$   
 $U_{bg2} = 190 V$   
 $R_{g2} = 2,7 k\Omega$   
 $U_{g1} = \text{Parameter}$



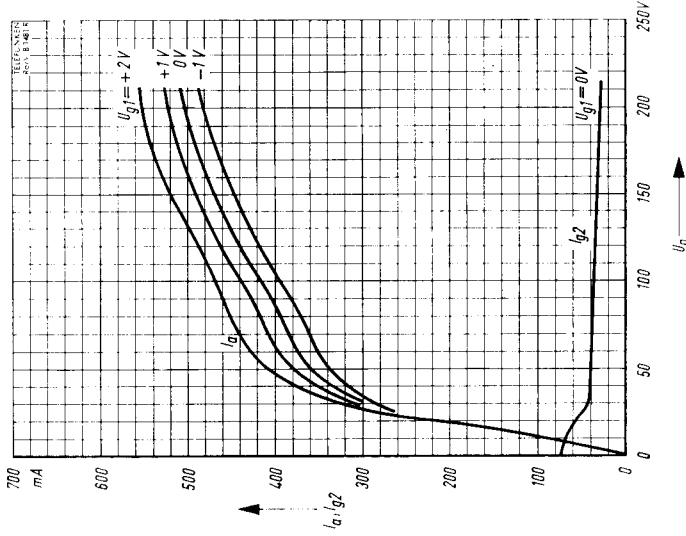

$I_c, I_{g2} = f(U_a)$   
 $U_{bg2} = 215 V$   
 $R_{g2} = 2,2 k\Omega$   
 $U_{g1} = \text{Parameter}$

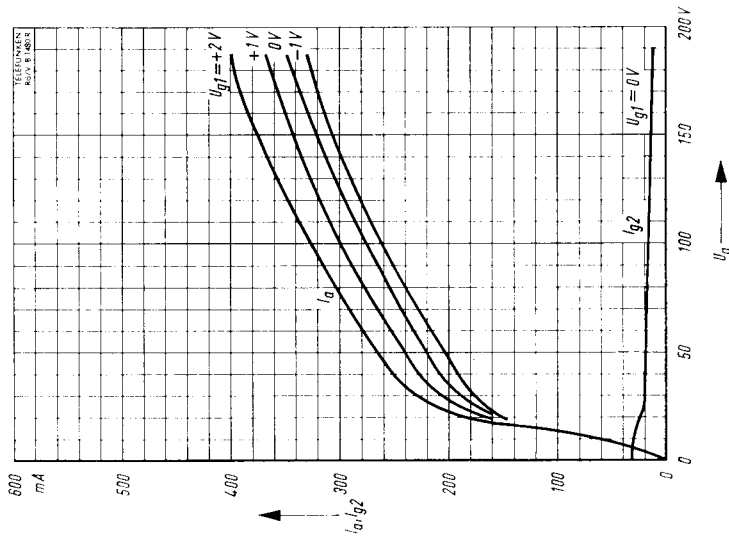

$I_c, I_{g2} = f(U_a)$   
 $U_{bg2} = 190 V$   
 $R_{g2} = 4,7 k\Omega$   
 $U_{g1} = \text{Parameter}$



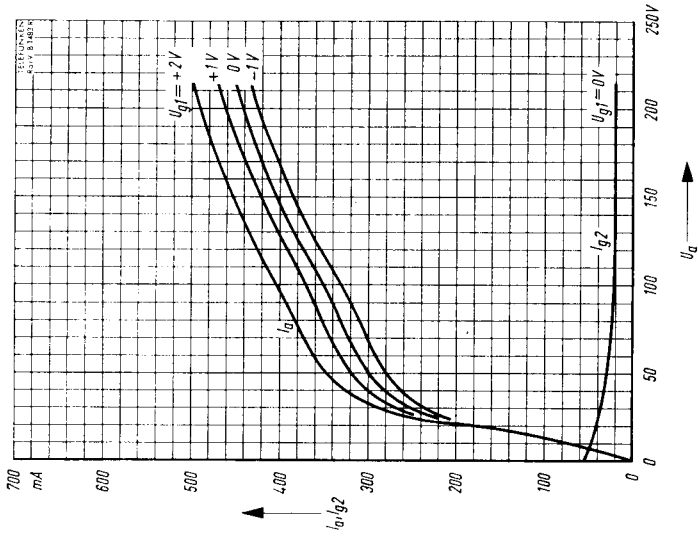

$I_{D1}, I_{D2} = f(U_G)$   
 $U_{B_{G2}} = 215V$   
 $R_{G2} = 3,3 k\Omega$   
 $U_{G1} = \text{Parameter}$

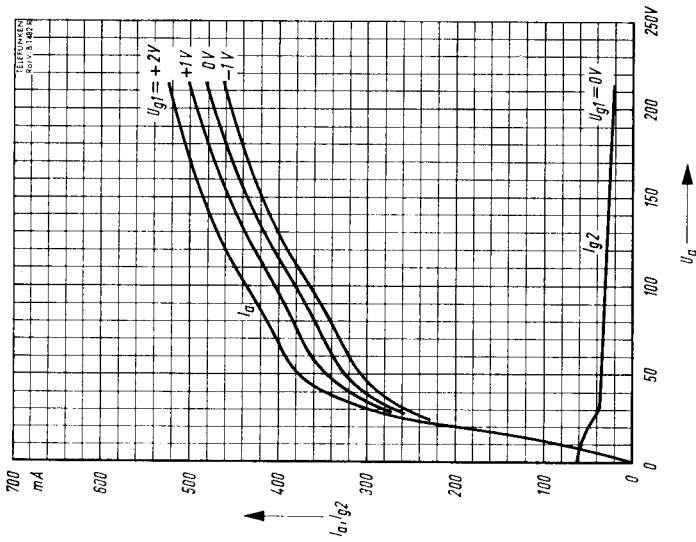

$I_{D1}, I_{D2} = f(U_G)$   
 $U_{B_{G2}} = 215V$   
 $R_{G2} = 2,7 k\Omega$   
 $U_{G1} = \text{Parameter}$



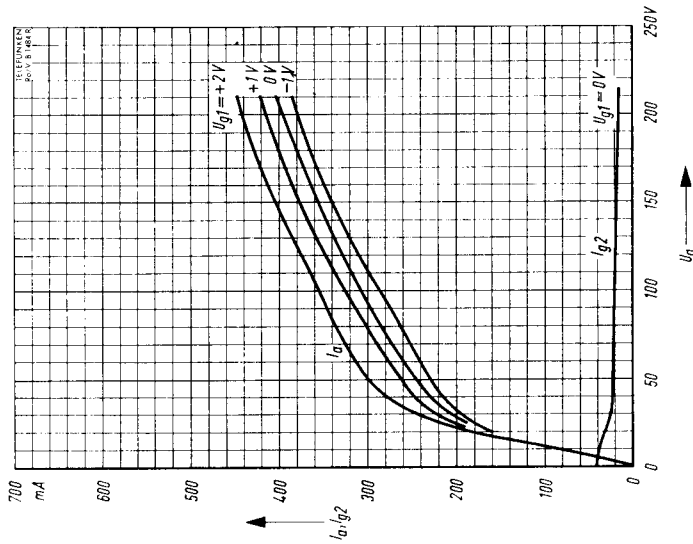
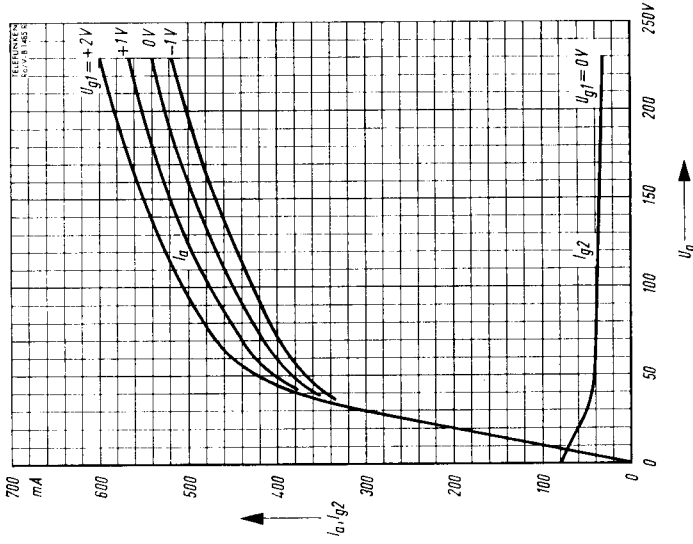

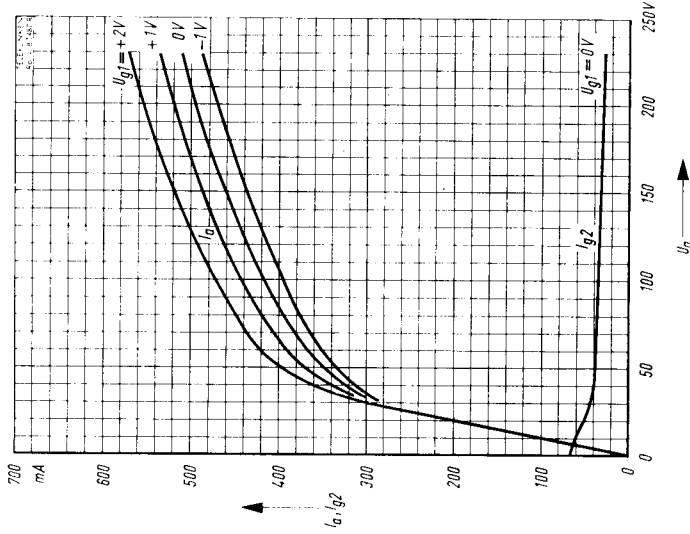

$I_a, I_{g2} = f(U_{g1})$   
 $U_{bg2} = 230 \text{ V}$   
 $R_{g2} = 2,7 \text{ k}\Omega$   
 $U_{g1} = \text{Parameter}$

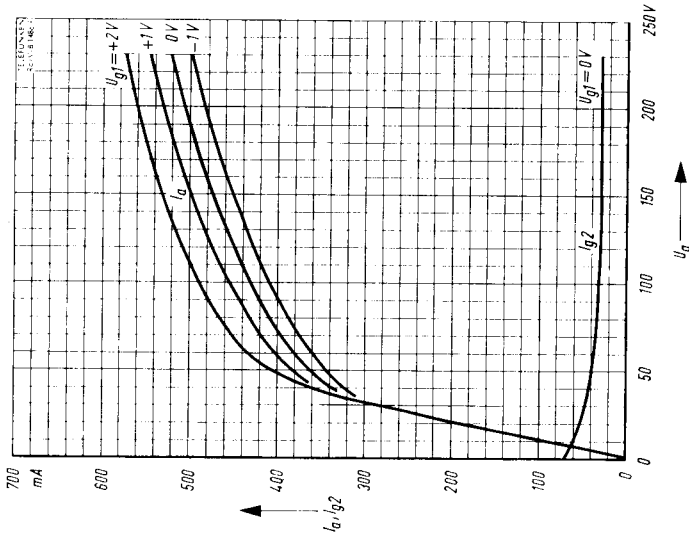

$I_a, I_{g2} = f(U_{g1})$   
 $U_{bg2} = 230 \text{ V}$   
 $R_{g2} = 2,5 \text{ k}\Omega$   
 $U_{g1} = \text{Parameter}$



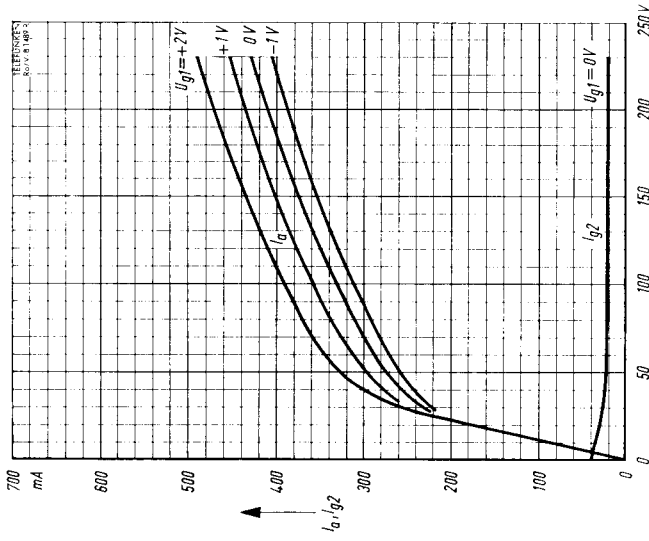

$I_a, I_{g2} = f(U_a)$   
 $U_{bg2} = 230V$   
 $R_{g2} = 4,7 k\Omega$   
 $U_{g1} = \text{Parameter}$

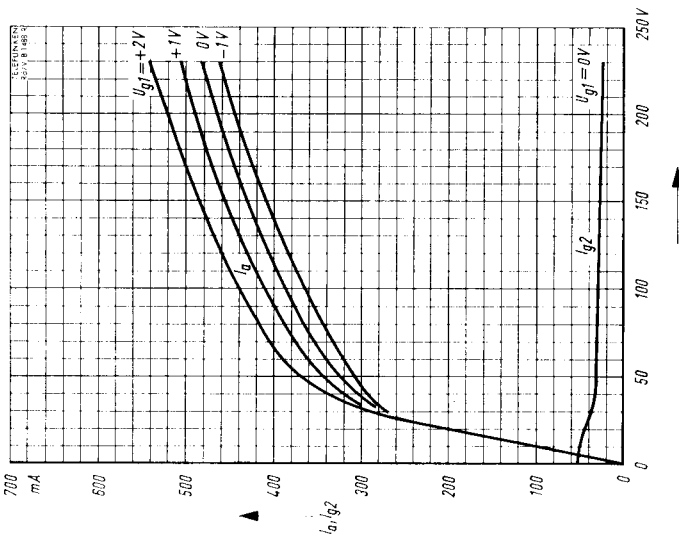

$I_a, I_{g2} = f(U_a)$   
 $U_{bg2} = 230V$   
 $R_{g2} = 3,3 k\Omega$   
 $U_{g1} = \text{Parameter}$

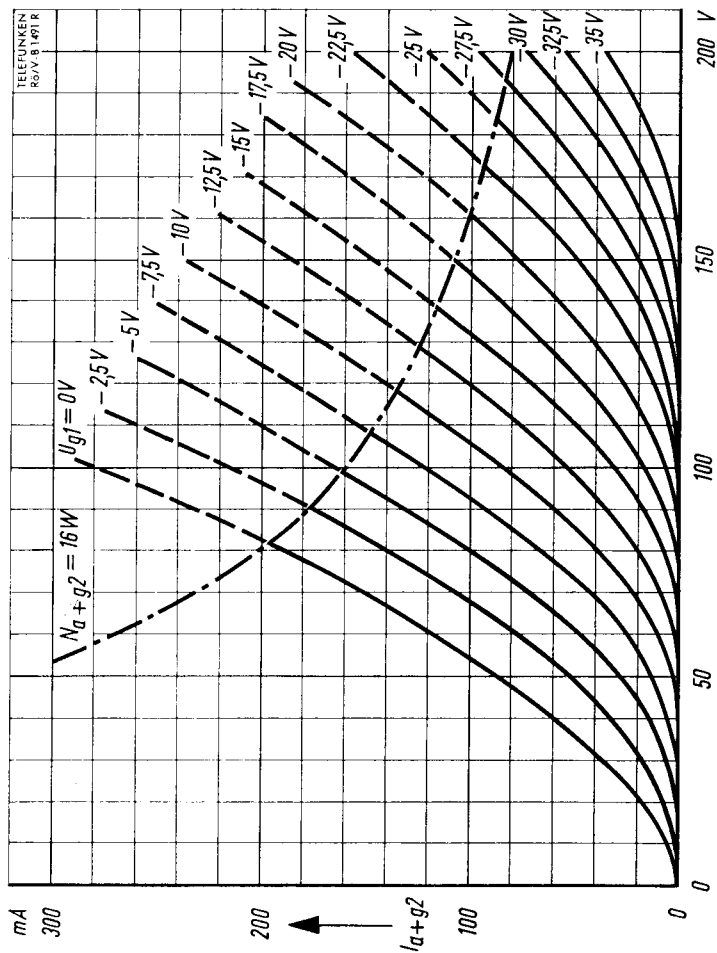

$I_{a+g2} = f(U_{ag2})$   
 $U_{g1} = \text{Parameter}$

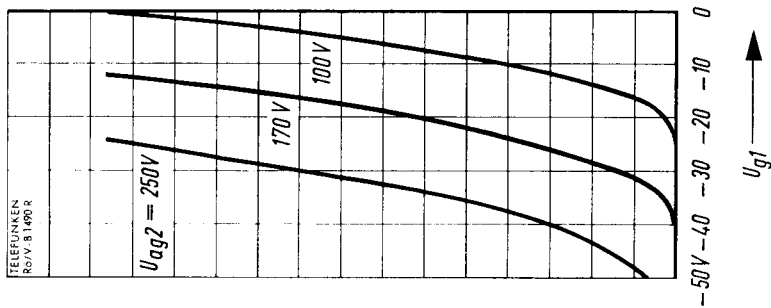

$I_{a+g2} = f(U_{g1})$   
 $U_{ag2} = \text{Parameter}$

Als Triode geschaltet · Connected as triode





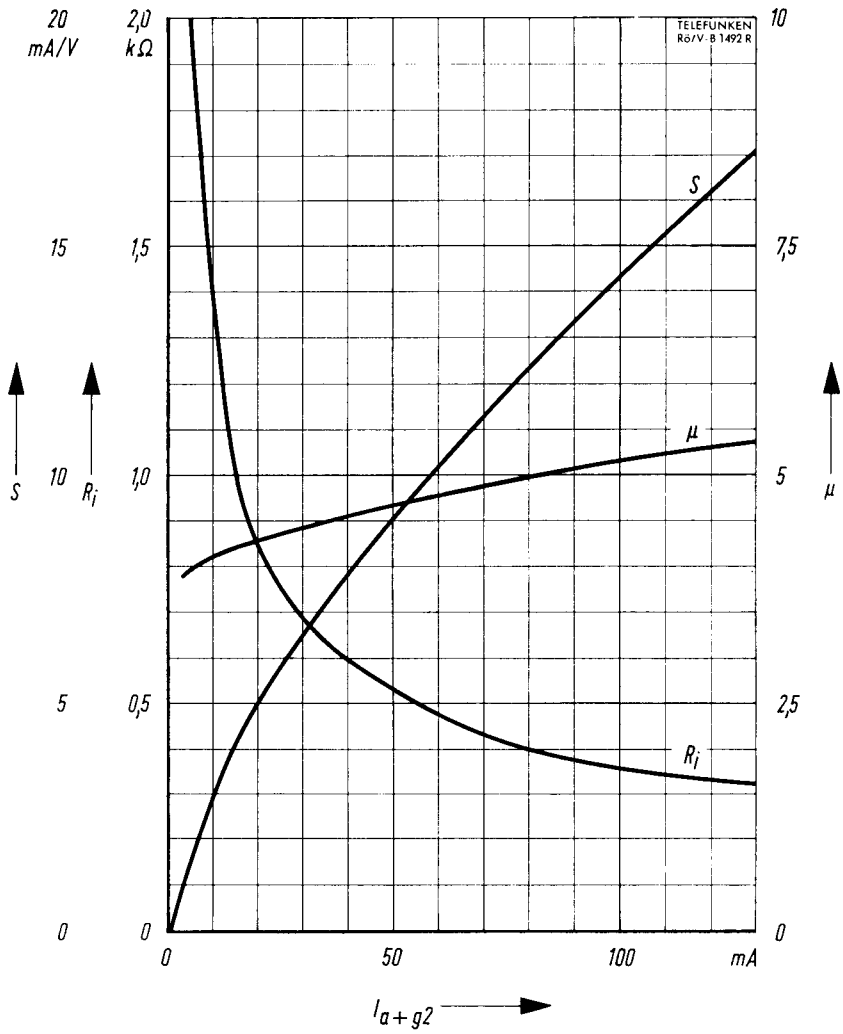

$S, R_i, \mu = f(I_a + g_2)$   
 $U_{ag2} = 100 \text{ V}$

Als Triode geschaltet · Connected as triode



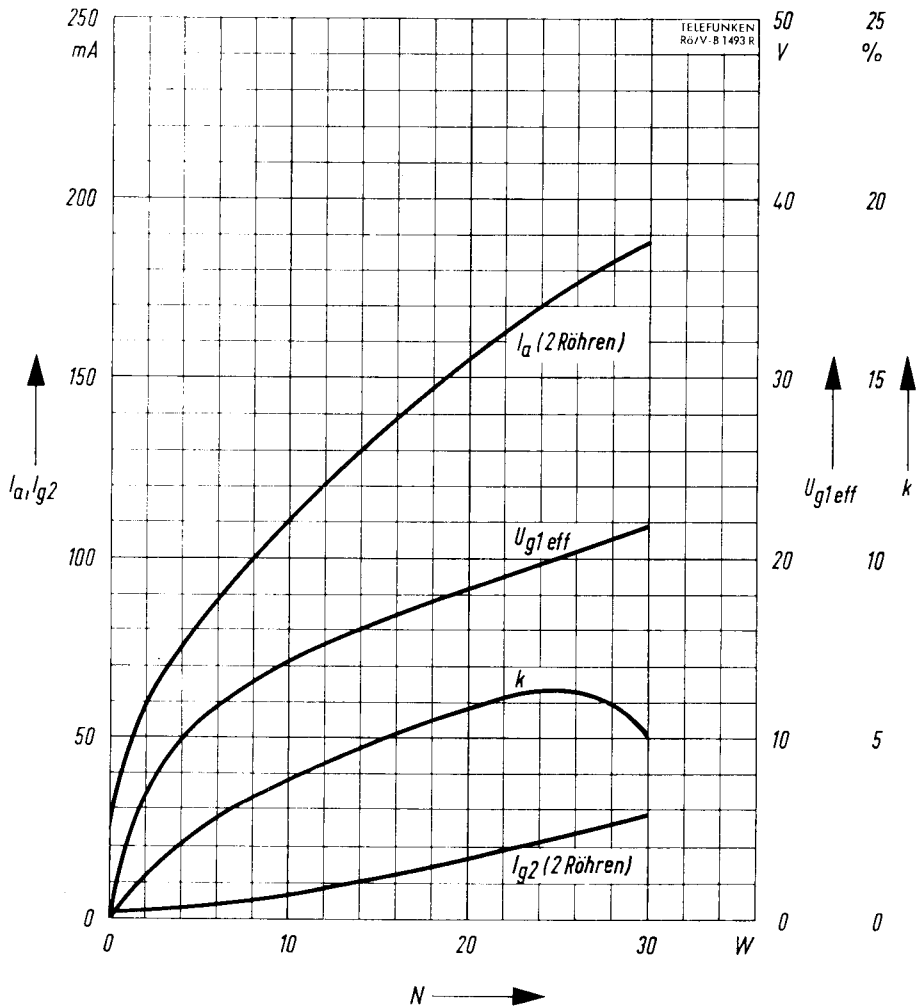

$$I_a, I_{g2}, U_{g1eff}, k = f(N)$$

- $U_a = 250 \text{ V}$
- $U_{g2} = 170 \text{ V}$
- $U_{g1} = -34 \text{ V}$
- $R_{aa} = 3 \text{ k}\Omega$
- $R_{g2} = 2 \times 0,5 \text{ k}\Omega$

2 Röhren in **Gegentakt-B-Betrieb** · 2 tubes push-pull, class B

