

Radiotron Type KT61 Power Output Tetrode

General

The KT61 valve is a high slope power amplifier tetrode fitted with a six watt indirectly heated cathode, for use in the output stage of an audio amplifier.

It has a high power sensitivity and should not normally be used in amplifiers which already have a high order of audio gain (in excess of 80 db), if microphony is to be avoided.

Maximum ratings and typical operating conditions are as follows:—

Heater:

Voltage	6.3 a.c. or d.c. volts
Current	0.95 approx. amp.

Direct Interelectrode Capacitances:

Plate to Grid	1.6 $\mu\mu\text{F}$
Input	17.3 $\mu\mu\text{F}$
Output	10.2 $\mu\mu\text{F}$
Maximum Overall Length	$4\frac{11}{16}$ "
Maximum Diameter	$1\frac{3}{4}$ "
Base	Octal 7-pin



- Pin 1. Not Connected.
- Pin 2. Heater.
- Pin 3. Plate.
- Pin 4. Screen Grid.
- Pin 5. Control Grid.
- Pin 6. Pin omitted.
- Pin 7. Heater.
- Pin 8. Cathode.

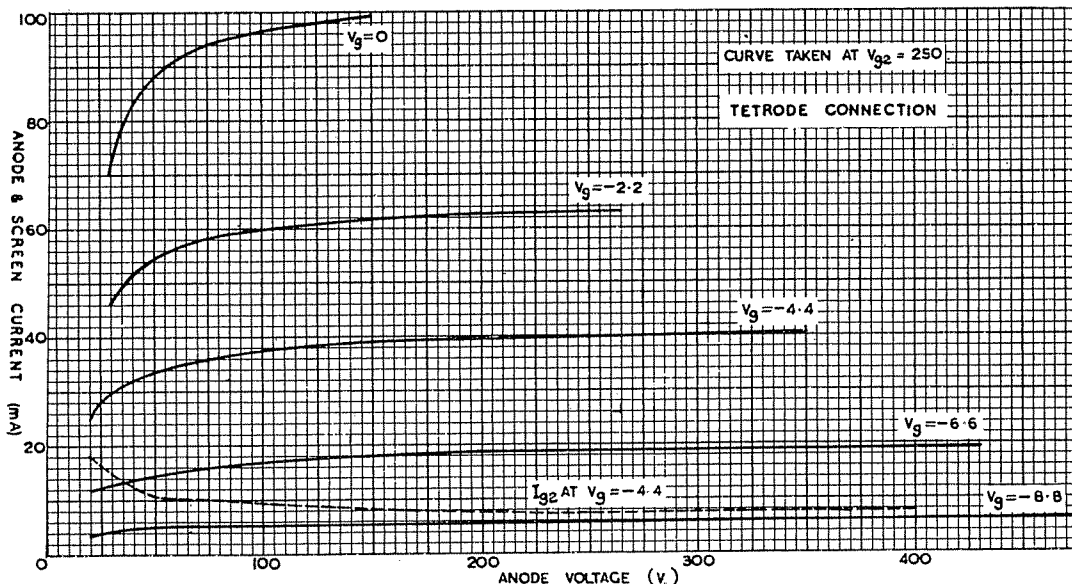
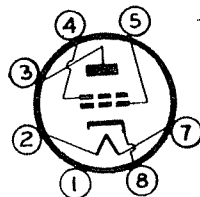

Fig. 1.

Characteristics

	Tetrode	Triode
Plate Voltage	275 V max.	350 V max.
Plate Current	40 mA max.	40 mA max.
Plate Dissipation	10 W max.	10 W max.
Screen Voltage	275 V max.	
Screen Current	7.5 mA max.	
Screen Dissipation	1.9 W	
Self Bias Resistance	90 ohms	
Mutual Conductance	10,500 μ mhos*	13,000 μ mhos†

Single valve class "A" amplifier: tetrode connection

For optimum results the KT61 valve should be operated at a plate and screen voltage of 250V, the conditions being set forth in the table below.

The plate load impedance should be kept nearly constant over the working frequency range if a level response is desired.

One suitable circuit is shown in Fig. 2: the valve is preceded by a triode or diode-triode such as the 6AV6. The overall gain given by this combination is high and full output will be obtained with an input signal of about 0.1V peak; should this sensitivity be considered excessive a simple degenerative circuit may be used as Fig. 3.

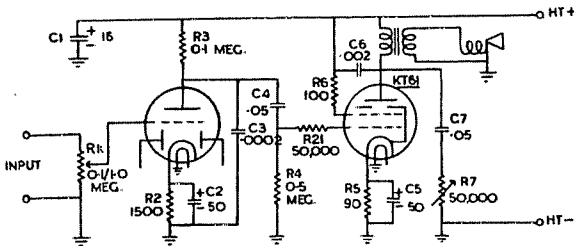

Fig. 2.

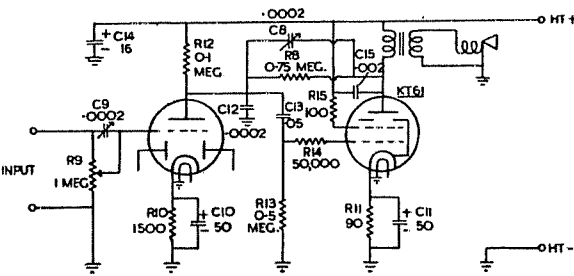

Fig. 3.

To prevent instability and parasitic oscillation a resistance of 100 ohms is placed in the tetrode screen circuit. This is more effective than the usual plate stopper and should always be used on valves of the tetrode type, especially with push-pull operation. A grid stopper is also recommended.

* Measured at $E_a = E_s = 250V, I_a = 40mA$.

† Measured at $E_a = 250V, I_a = 30mA$.

The output transformer should be designed to handle the plate current of this valve, while still maintaining a high inductance and low leakage inductance: its approximate ratio may be obtained by:

$$\frac{\text{Primary turns}}{\text{Secondary turns}} = \sqrt{\frac{\text{Opt. load impedance}}{\text{Voice coil impedance}}}$$

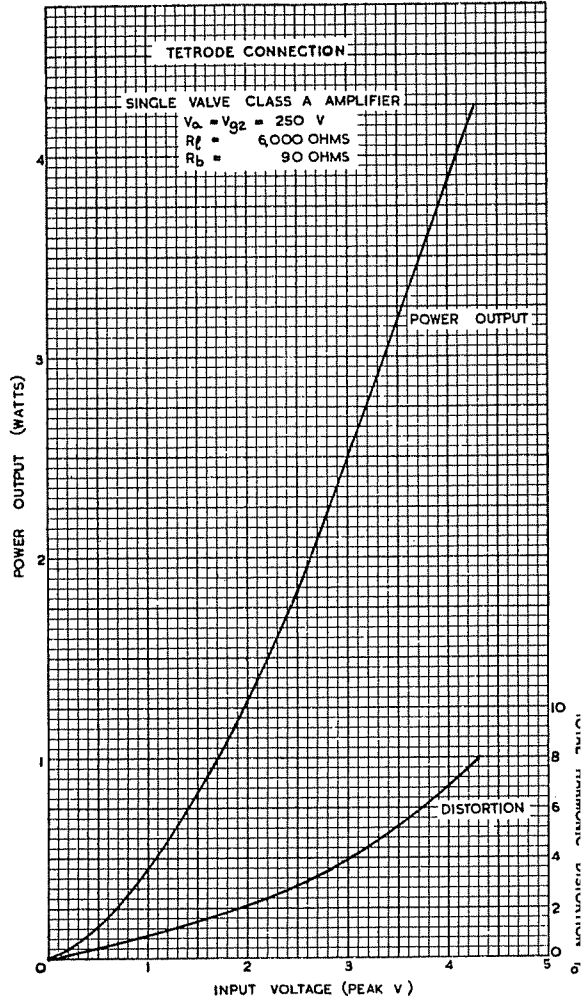

Fig. 4.

Operating data

Plate voltage	250V max.
Screen voltage	250V max.
Plate current	40 mA
Screen current	7.5 mA
Bias resistance	90 ohms.
Plate load impedance	6000 ohms.
Input signal to grid	4.3V peak, 3V r.m
Power output	4.3W
Distortion	8%

At full load the plate current decreases slightly with a corresponding increase in screen current. The performance of the KT61 is shown in Fig. Due to the high sensitivity of this valve, degener

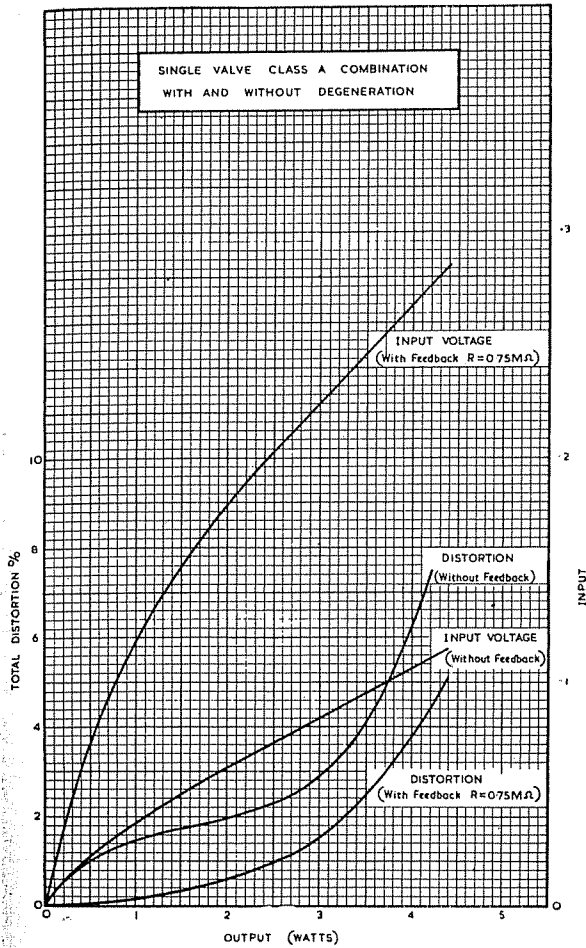

Fig. 5.

tion can be incorporated — Fig. 3 gives a recommended circuit — the overall sensitivity is reduced, but is still high enough for normal use. Degeneration is introduced into the plate circuit of the triode by means of the resistance $R8$: the curves in Fig. 5 show the reduction in distortion and sensitivity to be expected. An even more important advantage is the levelling of the frequency response when an inductive load is used — the curves in Fig. 6, demonstrate the improvement on a typical loudspeaker — it will be seen that the bass resonance is largely removed and that the tendency for the output to increase with frequency is prevented. In simple superheterodyne receivers the attenuation of the higher audio frequencies by the i-f amplifier is partly compensated by the rising frequency response of the output stage — degeneration prevents this, making it desirable to boost the treble in another part of the circuit — a small condenser $C9$, preferably variable, connected across the volume control $R9$ will perform this function.

The effect of a small condenser in parallel with the resistance $R8$ is also shown: a considerable range of tone control is possible, and this should be used instead of the usual series resistance-condenser method, which is inoperative with degeneration.

Two valve class AB push pull amplifier: tetrode connection

The KT61 valve is suitable for use in push-pull amplifiers when a higher output is required. A suitable circuit is shown in Fig. 7; the driver transformer can be of low ratio and degeneration can be added if desired. The curves in Fig. 8 show the performance, under 250 volt conditions.

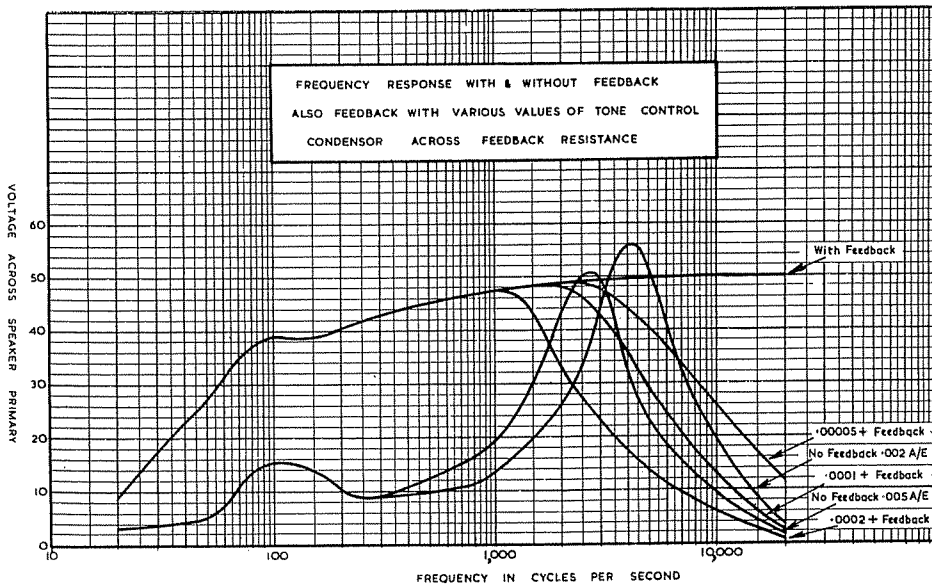

Fig. 6.

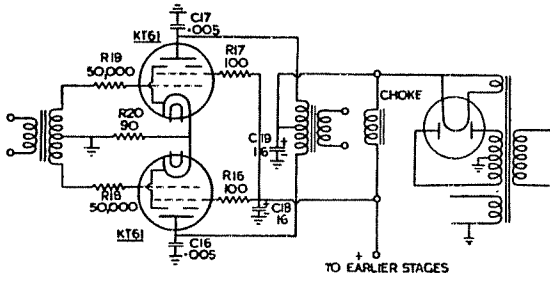

Fig. 7.

The plate and screen currents rise slightly at full load but a power unit having a regulation equal to 500-750 ohms internal resistance is suitable. If desired the plate supply may be taken direct from the first smoothing condenser, due to the small amount of filtration necessary; the screen supply and the plate supply to the earlier valves must be smoothed in the normal manner.

Stopper resistances are desirable in the screen and control grid circuits to prevent parasitic oscillation.

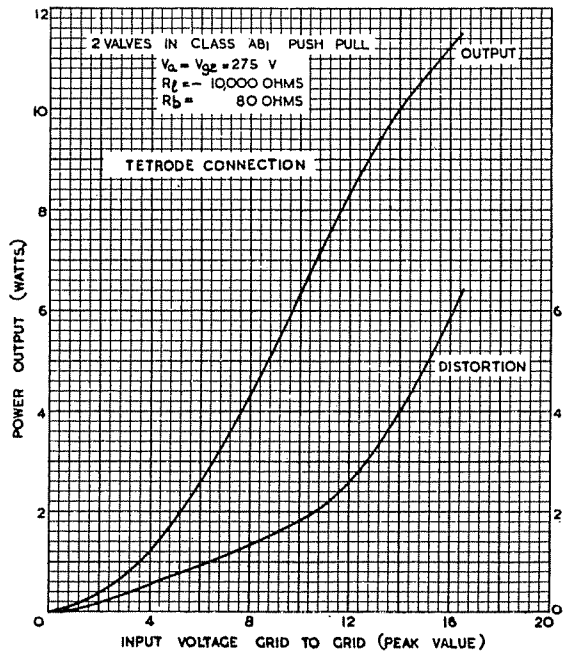

Fig. 9.

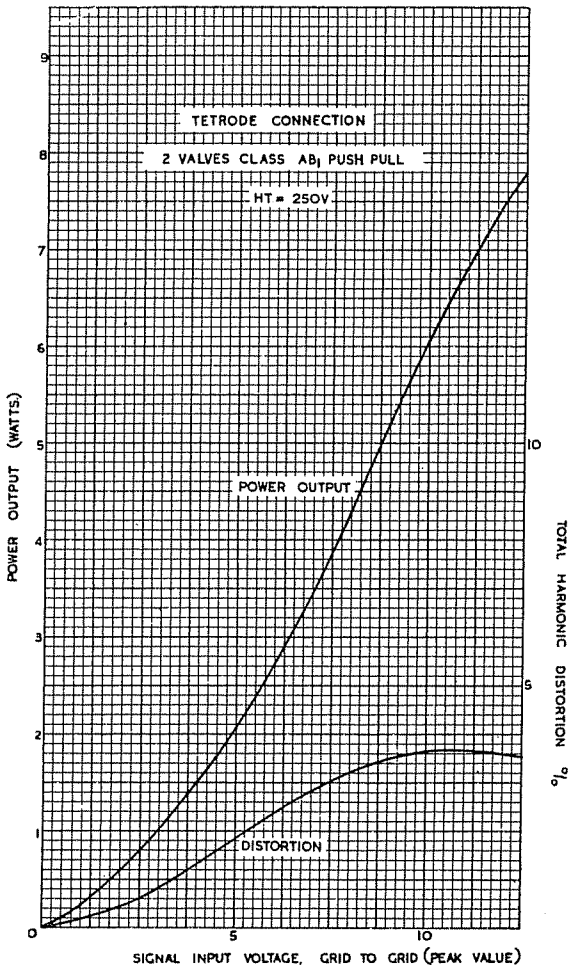

Fig. 8.

Operating data

Plate voltage	250 V max.
Screen voltage	250 V max.
Plate current (2 valves)	56 mA
Screen current (2 valves)	12 mA
Control grid bias	-6 V approx.
Power output	8.6 W
Distortion	4%
Input signal (grid to grid)	14V peak, 10V r.m.s.
Plate load impedance	10,000 ohms
Common bias resistance	90 ohms.

The plate current will rise 10% at full load while the screen current assumes a value approximately double that given above.

When a greater output is required it is permissible to increase the applied voltage to 275V. It must be remembered that the screen current maximum signal is nearly twice that at no signal so that the screen dissipation at this point must not exceed the maximum, i.e. 3 watts per valve. Suitable conditions are given below and the circuit recommended is that shown in Fig. 7.

Operating data

Plate and screen voltage	275 V
Plate current per pair (no signal)	72 mA
Screen current per pair (no signal)	12 mA
Screen dissipation at maximum signal	3 W

Plate to plate load	10,000 ohms
Common self-bias resistance	80 ohms
Input signal (grid to grid)	17.5V peak, 12.3V r.m.s.
Power output	11.5 W
Distortion	6.5%

At maximum signal the total plate current increases to 76 mA, and the screen current is almost doubled. It will be noticed that the self-bias resistance has been lowered in value; this is also satisfactory at $E_a = 250$ volts. The curves in Fig. 9 give the performance in detail.

Two valves push-pull class AB1: triode connected

The KT61 valve may be used triode connected in a push-pull circuit when a reasonable power output is required, coupled with very low distortion: suitable conditions are given below, using the circuit shown in Fig. 10.

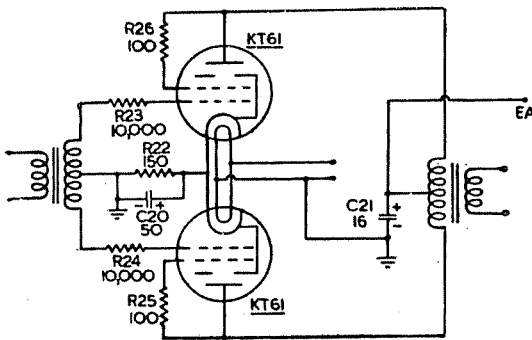

Fig. 10.

Operating data

Plate and screen voltage	350 V
Plate and screen current per pair	63 mA
Plate to plate load	6,000 ohms
Common self-bias resistance	150 ohms
Power output	6 W
Distortion	2%
Signal input (grid to grid)	23V peak, 16.3V r.m.s.

There is a rise in plate current of 10 mA at maximum signal. The curves, Fig. 11, show the performance in detail. The condenser C20, shunting the bias resistance should not be omitted: a big increase in the distortion will occur if this is done.

The screen grids are joined to the plates via small resistances R25 and R26: These in conjunction with the grid stoppers R23 and R24, suppress parasitic oscillations.

Curves connecting power output with applied voltage for a single valve, and for two valves in push-pull, are given in Fig. 12. Triode characteristics are shown in Fig. 13.

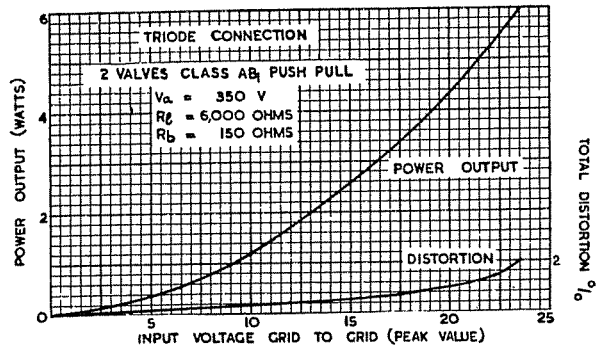

Fig. 11.

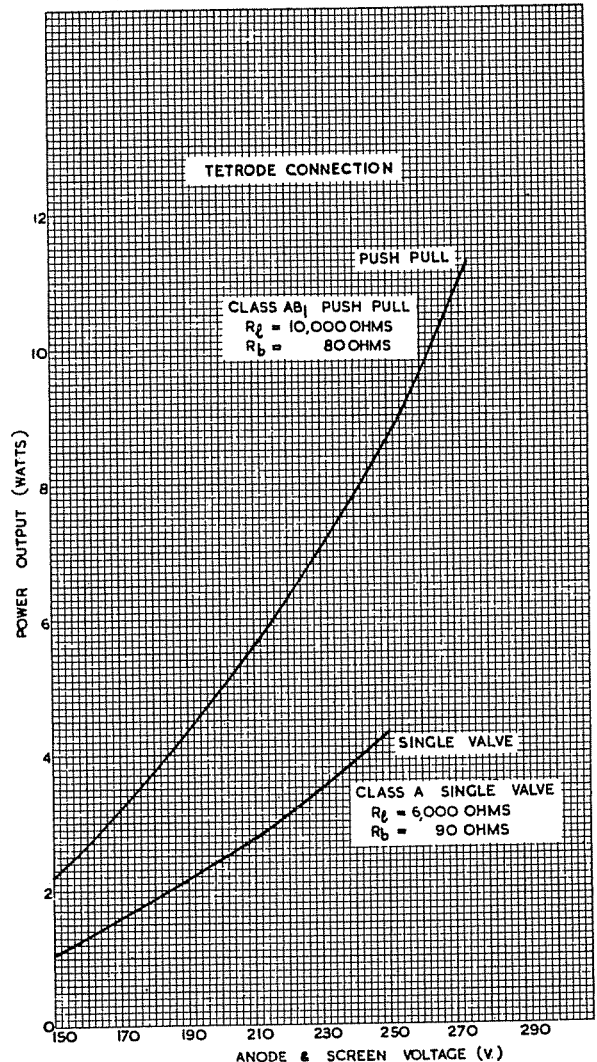

Fig. 12.

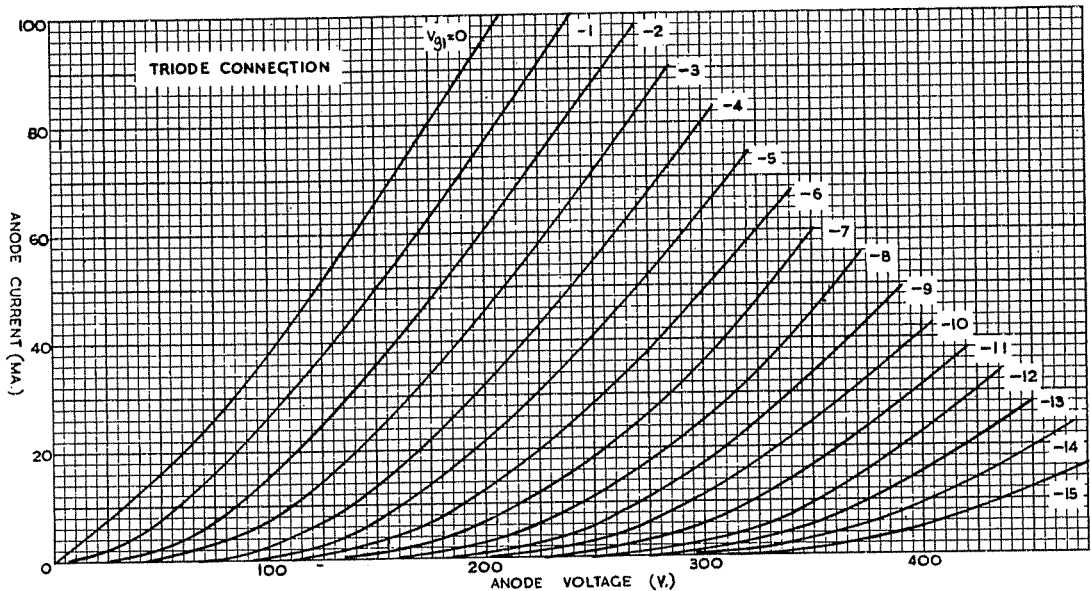

Fig. 13.

Precautions

- The following precautions should be observed:
- (1) Self bias must always be used due to the high mutual conductance.
 - (2) A screen stopper resistance should be used.
 - (3) The control grid to cathode resistance should not exceed 0.5 megohm.
 - (4) The plate and grid circuits must be isolated.
 - (5) The valve must not be operated with screen voltage applied if the plate is disconnected from the H.T. supply.
 - (6) Adequate ventilation must be provided.
 - (7) The voltage between heater and cathode should not be excessive.

Component values

R1	0.1 – 1.0 megohm	C1	16 μ F	R7	50000 ohms	C7	0.05 μ F
R2	1500 ohms	C2	50 μ F	R8	0.75 megohm	C8	0.0002 μ F
R3	0.1 megohm	C3	0.0002 μ F	R9	1.0 megohm	C9	0.0002 μ F
R4	0.5 megohm	C4	0.05 μ F	R10	1500 ohms	C10	50 μ F
R5	90 ohms	C5	50 μ F	R11	90 ohms	C11	50 μ F
R6	100 ohms	C6	0.002 μ F	R12	0.1 megohm	C12	0.0002 μ F
				R13	0.5 megohm	C13	0.05 μ F
				R14	50000 ohms	C14	16 μ F
				R15	100 ohms	C15	0.002 μ F
				R16	100 ohms	C16	0.005 μ F
				R17	100 ohms	C17	0.005 μ F
				R18	50000 ohms	C18	16 μ F
				R19	50000 ohms	C19	16 μ F
				R20	90 ohms	C20	50 μ F
				R21	50000 ohms	C21	16 μ F
				R22	150 ohms		
				R23	10000 ohms		
				R24	10000 ohms		
				R25	100 ohms		
				R26	100 ohms		