

Medium-Mu Triode

NUVISTOR TYPE

Heater Designed to Operate from Battery Supplies
Used in Sonobuoy and Other Expendable Equipment

Electrical:

Heater Characteristics and Ratings:

Voltage (DC). Tubes will be supplied with the heater designed to operate within $\pm 10\%$ of any specified center heater voltage between 6.0 and 8.5 volts to meet specific battery-supply requirements in sonobuoy and other expendable equipment.

Input 0.85 watt

Peak heater-cathode voltage:

Heater negative with respect to cathode. 100 max. volts

Heater positive with respect to cathode. 100 max. volts

Direct Interelectrode Capacitances (Approx.):

Grid to plate 2.1 pf

Grid to cathode, shell, and heater. 4.0 pf

Plate to cathode, shell, and heater 1.7 pf

Plate to cathode. 0.34 pf

Heater to cathode 1.4 pf

Characteristics, Class A₁ Amplifier:

Heater Voltage. Specified center value

Plate Supply Voltage. 24 volts

Grid. Connected to negative end of cathode resistor

Cathode Resistor. 100 ohms

Amplification Factor. 11.5

Plate Resistance (Approx.). 1530 ohms

Transconductance. 7500 μ mhos

Plate Current 8.7 ma

Grid Voltage (Approx.) for plate $\mu a = 50$ -5 volts

Mechanical:

Operating Position. Any

Type of Cathode Coated Unipotential

Maximum Overall Length. 0.800"

Maximum Seated Length 0.625"

Maximum Diameter. 0.440"

Weight (Approx.). 1.9 grams

Envelope. Metal Shell MT4

Socket. See *Socket & Connector Information*

for RCA Nuvistor Tubes at front of this Section

Base. Medium Ceramic-Wafer Twelvar 5-Pin (JEDEC No. E5-65)



Basing Designation for BOTTOM VIEW 12AQ

- Pin 1^a - Do Not Use
- Pin 2 - Plate
- Pin 3^a - Do Not Use
- Pin 4 - Grid
- Pin 5^a - Do Not Use
- Pin 6^a - Do Not Use
- Pin 7^a - Do Not Use
- Pin 8 - Cathode
- Pin 9^a - Do Not Use
- Pin 10 - Heater
- Pin 12 - Heater

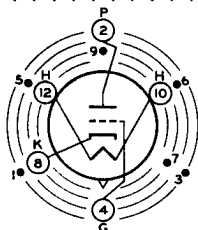

INDEX=LARGE LUG
 ●=SHORT PIN; IC=DO NOT USE

AMPLIFIER — Class A

Maximum Ratings, Absolute-Maximum Values:

For operation at any altitude

Plate Voltage.	50 max.	volts
Grid Voltage:		
Negative-bias value.	55 max.	volts
Peak-positive value.	2 max.	volts
Grid Current	2 max.	ma
Cathode Current.	15 max.	ma
Plate Dissipation.	0.45 max.	watt

Typical Operation:

Heater Voltage	Specified center value	
Plate Supply Voltage	12	24 volts
Grid Voltage	-	-0.7 volt
Grid Resistor.	33000	- ohms
Amplification Factor	12	12
Plate Resistance (Approx.)	1500	1500 ohms
Transconductance	8000	8000 μ hos
Plate Current.	5.5	9.5 ma

Maximum Circuit Values:

Grid-Circuit Resistance: ^b		
For fixed-bias operation	10 max.	megohms
For cathode-bias operation	10 max.	megohms

^a Pins 1, 3, 5, 6, 7, and 9 are of a length such that their ends do not touch the socket insertion plane.

^b For operation at metal-shell temperatures up to 150° C. measured in Zone "A" as shown on *Dimensional Outline*. For operation at metal-shell temperatures above 150° C, see accompanying *Grid-Circuit-Resistance Rating Chart*.



CHARACTERISTICS RANGE VALUES

	Note	Min. $\left[\frac{0.85}{E_f(\text{ctr})} \right]$	Max. $\left[\frac{0.85}{E_f(\text{ctr})} \right]$	
Heater Current . . .	1	0.95	1.05	amp
Direct Interelectrode Capacitances:				
Grid to plate. . .	2	1.8	2.4	pf
Grid to cathode, shell, and heater	2	3.4	4.6	pf
Plate to cathode, shell, and heater	2	1.4	2.0	pf
Plate to cathode .	2	0.26	0.42	pf
Heater to cathode.	2	1.1	1.7	pf
Plate Current (1).	1,3	6.7	10.7	ma
Plate Current (2).	1,4	-	50	μ a
Transconductance (1)	1,3	6500	8500	μ hos
Transconductance (2)	3,5	5700	-	μ hos
Reverse Grid Current	1,6	-	0.05	μ a
Amplification Factor	1,3	9	14	
Heater-Cathode Leakage Current:				
Heater negative with respect to cathode. . . .	1,7	-	5	μ a
Heater positive with respect to cathode. . . .	1,7	-	5	μ a
Leakage Resistance:				
Between grid and all other electrodes tied together	1,8	5000	-	megohms
Between plate and all other electrodes tied together	1,9	10000	-	megohms

Note 1: With dc heater volts = specified center value, $E_f(\text{ctr})$.

Note 2: Measured in accordance with EIA Standard RS-191-A.

Note 3: With dc plate supply volts = 24, grid and metal shell connected to negative end of cathode resistor, cathode resistor (ohms) = 100, and cathode-bypass capacitor (μ f) = 1000.

Note 4: With dc plate volts = 24, dc grid volts = -10, and metal shell connected to ground.

Note 5: With dc heater volts = 0.9 specified center value.

Note 6: With dc plate supply volts = 40, dc grid supply volts = -2, grid circuit resistance (megohms) ≤ 1 (the internal resistance of the current meter used for this measurement), and metal shell connected to ground.

Note 7: With dc heater-cathode volts = 100.

Note 8: With grid 100 volts negative with respect to all other electrodes tied together, and metal shell connected to ground.

Note 9: With plate 300 volts negative with respect to all other electrodes tied together, and metal shell connected to ground.



SPECIAL TESTS

Short-Duration Shock (1):

Peak Impact Acceleration. 1000 g

This test is performed on a sample lot of tubes to determine the ability of the tube to withstand the specified Peak Impact Acceleration. Tubes are held rigid in each of four different positions (X_1 , X_2 , Y_1 , and Y_2) in a Navy-Type High-Impact (Fly-weight) Shock Machine and, with tube-electrode voltages applied, are subjected to 20 blows (5 in each position) at the specified Peak Impact Acceleration.

At the end of this test, tubes are criticized for Continuity and Shorts, Transconductance (I), Reverse Grid Current, and Heater-Cathode Leakage Current.

Long-Duration Shock (2):

Peak Impact Acceleration. 50 g

This test is performed, using a half-sine-wave, 11-milli-second, mechanical shock pulse, on a sample lot of tubes from each production run to determine the ability of the tube to withstand the specified Peak Impact Acceleration. Tubes are held rigid in each of two positions in three mutually perpendicular axes on a free-fall table. The longitudinal axis of the tube is coincident with one of the three axes. The table is dropped a total of 18 times to a horizontal surface from a height sufficient to produce the specified Peak Impact Acceleration. The material of the horizontal surface is such that the duration of the half-sine-wave shock pulse is 11-milli-seconds. No tube-electrode voltages are applied during this test.

At the end of this test, tubes are criticized for Continuity and Shorts, Transconductance (I), Reverse Grid Current, and Heater-Cathode Leakage Current.

Sweep-Frequency Fatigue Vibration:

This test is performed on a sample lot of tubes from each production run to determine the ability of the tube to withstand the Sweep-Frequency Fatigue Vibration specified below. Tubes are held rigid and operated with dc heater-cathode volts = 100. During operation, the tube is vibrated through the frequency range from 5 to 500 cps and back to 5 cps. One such vibration sweep cycle takes approximately 15 minutes. This cycle is repeated for a period of 3 hours along each of three mutually perpendicular axes for a total of 9 hours. The longitudinal axis of the tube is coincident with one of the three axes. The vibrations are applied as follows:

- a. The vibration from 5 to 50 cps is applied with a constant peak amplitude of 0.040 inch (0.080 inch peak-to-peak).
- b. The vibration from 50 to 500 cps is applied with a constant acceleration of 10 g.
- c. The vibration from 500 to 50 cps and then to 5 cps follows the same procedure, but in reverse.

At the end of this test, tubes are criticized for Continuity

and Shorts, Transconductance (I), Reverse Grid Current, and Heater-Cathode Leakage Current.

Low-Pressure Voltage Breakdown:

This test is performed on a sample lot of tubes from each production run to determine the ability of the tube to withstand high-altitude (low-air-pressure) conditions. Tubes are operated with 250 volts rms (60-cycle, ac) applied between plate and all other electrodes and metal shell connected together. Tubes must not break down or show evidence of corona when subjected to an air pressure (8.0 ± 0.5 mm Hg) corresponding to an altitude of 100,000 feet.

Continuity and Shorts:

This test is performed on a sample lot of tubes from each production run. Tubes are subjected to the Thyatron-Type Shorts Test described in MIL-E-10, Amendment 5, Paragraph 4.7.7, except that tapping is done by hand with a soft rubber tapper (Specifications for this tapper will be supplied upon request). The areas of acceptance and rejection for this test are shown in the accompanying *Shorts-Test Acceptance-Limits* graph. In this test, tubes are criticized for permanent or temporary shorts and open circuits.

Reliability Life (20 Hours):

This test is performed on a sample size (minimum of 80 tubes/lot for a 5-lot sampling plan or a minimum of 400 tubes for a single-lot sampling plan) designed to assure a process average AFR (Acceptable Failure Rate) of 0.5 per cent for Inoperatives and 2.1 per cent for Total Defectives and a process average RFR (Rejectable Failure Rate) of 2.0 per cent for Inoperatives and 4.7 per cent for Total Defectives.

During this test, tubes are operated at maximum-rated plate dissipation.

At the end of this test, tubes are criticized for Change in Transconductance (I), Inoperatives, and Total Defectives. A tube is considered Inoperative if it has a discontinuity, permanent short, or air leak.

Heater-Cycling Life (100 Hours)

Intermittent Operation 2000 cycles

This test is performed on a sample lot of tubes from each production run with heater volts = $1.35 \times$ specified center value cycled 1 minute ON and 2 minutes OFF, dc heater-cathode volts = -100, all other tube electrodes and metal shell connected to ground.

At the end of this test, tubes are criticized for Heater-Cathode Leakage Current, Open Heaters, Open Cathode Circuits, and Heater-Cathode Shorts.



Intermittent Life (100 Hours):

This test is performed on a sample lot of tubes from each production run.

During this test, tubes are operated at maximum-rated plate dissipation.

At the end of this test, tubes are criticized for Transconductance (I), Reverse Grid Current, Inoperatives, and Total Defectives. A tube is considered Inoperative if it has a discontinuity, permanent short, or air leak.

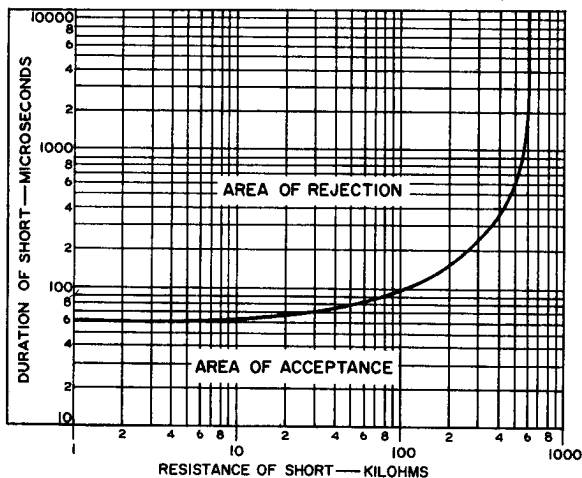
SHORTS-TEST ACCEPTANCE LIMITS

92CS-10465RI

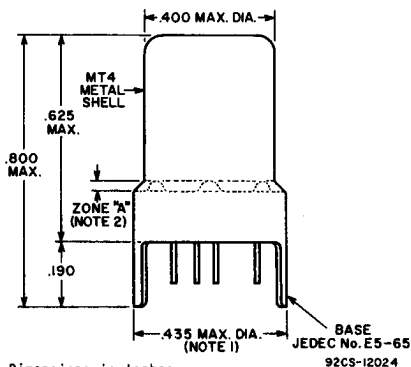

BOTTOM VIEW
Showing Arrangement of All 11 Base Pins

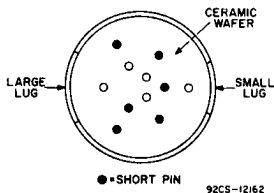

MODIFIED BOTTOM VIEW
With Element Connections Indicated
and Short Pins Not Shown

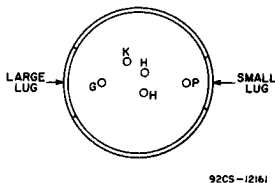

NOTE 1: MAXIMUM OUTSIDE DIAMETER OF 0.440" IS PERMITTED ALONG 0.190" LUG LENGTH.

NOTE 2: METAL-SHELL TEMPERATURE SHOULD BE MEASURED IN ZONE "A".



AVERAGE PLATE CHARACTERISTICS With Amplification Factor as Variable

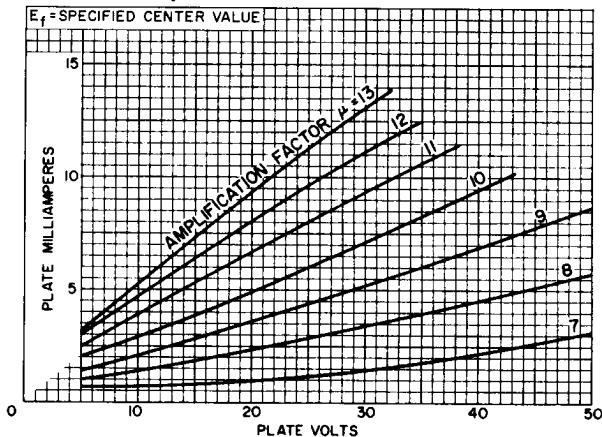

92CS-12165

AVERAGE PLATE CHARACTERISTICS With Transconductance as Variable

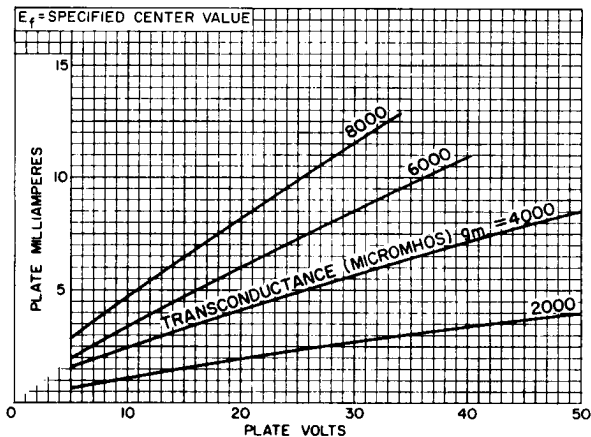

92CS-12166



AVERAGE PLATE CHARACTERISTICS

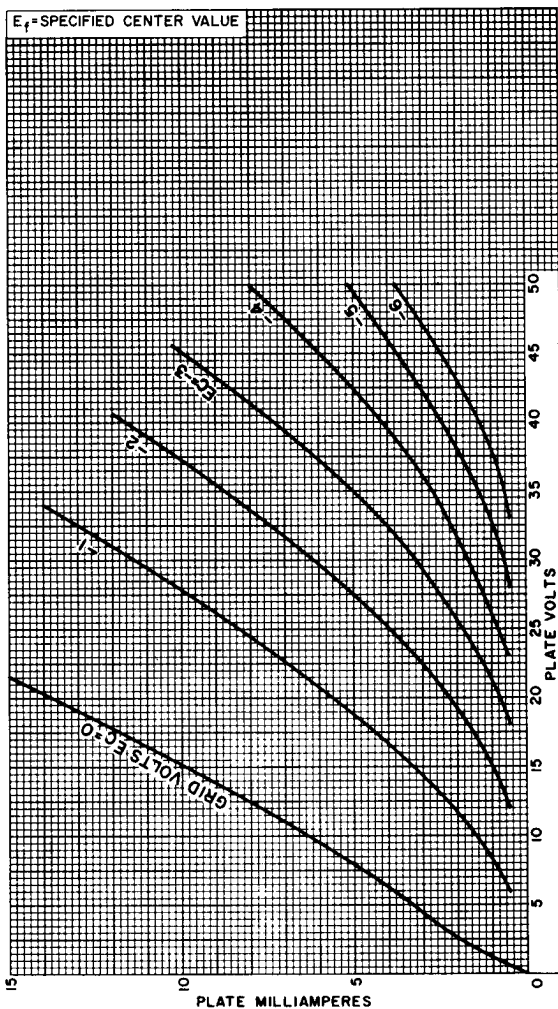

92CM-12167



AVERAGE PLATE CHARACTERISTICS With Plate Resistance as Variable

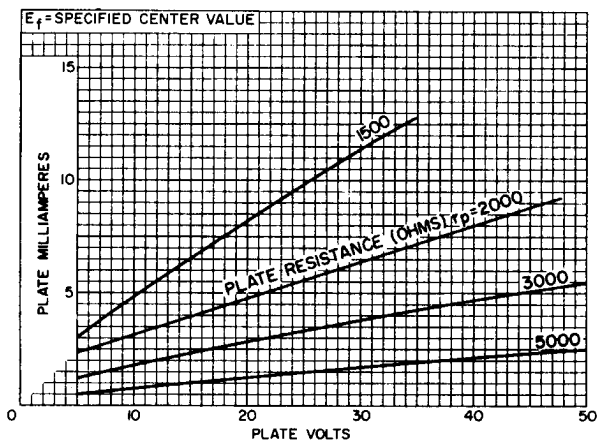

92CS-12164

GRID-CIRCUIT-RESISTANCE RATING CHART

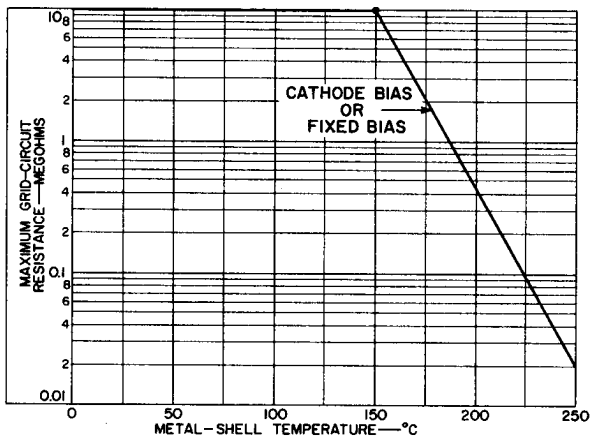

92CS-11479R1

