

24AUP4



24AUP4 PICTURE TUBE

Basing Designation for BOTTOM VIEW 12L

Pin 1 - Heater
Pin 2 - Grid No.1
Pin 6 - Grid No.4
Pin 10 - Grid No.2
Pin 11 - Cathode
Pin 12 - Heater

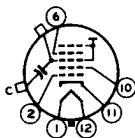

Cap - Ultor
(Grid No.3,
Grid No.5,
Collector)
C - External
Conductive
Coating

GRID-DRIVE[▲] SERVICE

Unless otherwise specified, voltage values are positive with respect to cathode

Maximum Ratings, Design-Center Values:

ULTOR VOLTAGE.	{ 20000 max. volts 12000* min. volts
GRID-No.4 (FOCUSING) VOLTAGE:	
Positive value	1000 max. volts
Negative value	500 max. volts
GRID-No.2 VOLTAGE.	500 max. volts
GRID-No.1 VOLTAGE:	
Negative-peak value.	200 max. volts
Negative-bias value.	140 max. volts
Positive-bias value.	0 max. volts
Positive-peak value.	2 max. volts
PEAK HEATER-CATHODE VOLTAGE:	
Heater negative with respect to cathode:	
During equipment warm-up period	
not exceeding 15 seconds	410 max. volts
After equipment warm-up period	180 max. volts
Heater positive with respect to cathode.	180 max. volts

Equipment Design Ranges:

With any ultor voltage (E_{c5k}) between 12000 and 20000 volts and grid-No.2 voltage (E_{c2k}) between 200 and 500 volts

Grid-No.4 Voltage for focus [§]	-75 to +400 volts
Grid-No.1 Voltage (E_{c1k}) for visual extinction of focused raster	See Raster-Cutoff-Range Chart for Grid-Drive Service
Grid-No.1 Video Drive from Raster Cutoff (Black Level):	
White-level value (Peak positive).	Same value as determined for E_{c1k} except video drive is a positive voltage
Grid-No.4 Current.	-25 to +25 μ a

▲, *, §: see next page.



24AUP4

PICTURE TUBE

24AUP4

Grid-No.2 Current.	-15 to +15	μ a
Field Strength of Adjustable Centering Magnet†.	0 to 8	gausses

Examples of Use of Design Ranges:

<i>With ultor voltage of</i>	18000	volts
<i>and grid-No.2 voltage of</i>	300	volts
Grid-No.4 Voltage for focus . . .	-75 to +400	volts
Grid-No.1 Voltage for visual extinction of focused raster. .	-35 to -72	volts
Grid-No.1 Video Drive from Raster Cutoff (Black Level):		
White-level value	35 to 72	volts

Maximum Circuit Values:

Grid-No.1-Circuit Resistance.	1.5 max.	megohms
---------------------------------------	----------	---------

CATHODE-DRIVE[■] SERVICE

Unless otherwise specified, voltage values are positive with respect to grid No.1

Maximum Ratings, Design-Center Values:

ULTOR-TO-GRID-No.1 VOLTAGE.	{ 20000 max. volts 12000* min. volts
GRID-No.4-TO-GRID-No.1 VOLTAGE:	
Positive value.	1000 max. volts
Negative value.	500 max. volts
GRID-No.2-TO-GRID-No.1 VOLTAGE.	640 max. volts
GRID-No.2-TO-CATHODE VOLTAGE.	500 max. volts
CATHODE-TO-GRID-No.1 VOLTAGE:	
Positive-peak value	200 max. volts
Positive-bias value	140 max. volts
Negative-bias value	0 max. volts
Negative-peak value	2 max. volts
PEAK HEATER-CATHODE VOLTAGE:	
Heater negative with respect to cathode:	
During equipment warm-up period not exceeding 15 seconds.	410 max. volts
After equipment warm-up period. . . .	180 max. volts
Heater positive with respect to cathode.	180 max. volts

Equipment Design Ranges:

With any ultor-to-grid-No.1 voltage (E_{c5g1}) between 12000 and 20000 volts and grid-No.2-to-grid-No.1 voltage (E_{c2g1}) between 225 and 640 volts

Grid-No.4-to-Grid-No.1 Voltage for focus§.	-75 to +400	volts
Cathode-to-Grid-No.1 Voltage (E_{kg1}) for visual extinction of focused raster	See Raster-Cutoff-Range Chart for Cathode-Drive Service	

*, †, §, †, ■: See next page.



PICTURE TUBE

Cathode-to-Grid-No.1 Video Drive from Raster Cutoff (Black Level):		
White-level value (Peak negative)	Same value as determined for E_{kg1} except video drive is a negative voltage	
Grid-No.4 Current	-25 to +25	μa
Grid-No.2 Current	-15 to +15	μa
Field Strength of Adjustable Centering Magnet†	0 to 8	gausses

Examples of Use of Design Ranges:

<i>With ultor-to-grid-</i>		
<i>No.1 voltage of</i>	18000	volts
<i>and grid-No.2-to-grid-</i>		
<i>No.1 voltage of</i>	300	volts
Grid-No.4-to-Grid-No.1 Voltage for focus	-75 to +400	volts
Cathode-to-Grid-No.1 Voltage for visual extinction of focused raster	33 to 60	volts
Cathode-to-Grid-No.1 Video Drive from Raster Cutoff (Black Level):		
White-level value	-33 to -60	volts

Maximum Circuit Values:

Grid-No.1-Circuit Resistance	1.5 max.	megohms
------------------------------	----------	---------

▲ Grid drive is the operating condition in which the video signal varies the grid-No.1 potential with respect to cathode.

● This value is a working design-center minimum. The equivalent absolute minimum ultor- or ultor-to-grid-No.1 voltage is 11,000 volts, below which the serviceability of the 24AUP4 will be impaired. The equipment designer has the responsibility of determining a minimum design value such that under the worst probable operating conditions involving supply-voltage variation and equipment variation the absolute minimum ultor- or ultor-to-grid-No.1 voltage is never less than 11,000 volts.

§ The grid-No.4 voltage or grid-No.4-to-grid-No.1 voltage required for focus of any individual tube is independent of ultor current and will remain essentially constant for values of ultor voltage (or ultor-to-grid-No.1 voltage) or grid-No.2 voltage (or grid-No.2-to-grid-No.1 voltage) within design ranges shown for these items.

† Distance from Reference Line for suitable PM centering magnet should not exceed 2-1/4". Excluding extraneous fields, the center of the undeflected focused spot will fall within a circle having a 1/2-inch radius concentric with the center of the tube face. It is to be noted that the earth's magnetic field can cause as much as 1/2-inch deflection of the spot from the center of the tube face.

■ Cathode drive is the operating condition in which the video signal varies the cathode potential with respect to grid No.1 and other electrodes.

*For X-ray shielding considerations, see sheet
X-RAY PRECAUTIONS FOR CATHODE-RAY TUBES
at front of this Section*



24AUP4

24AUP4

RASTER-CUTOFF-RANGE CHARTS GRID-DRIVE SERVICE

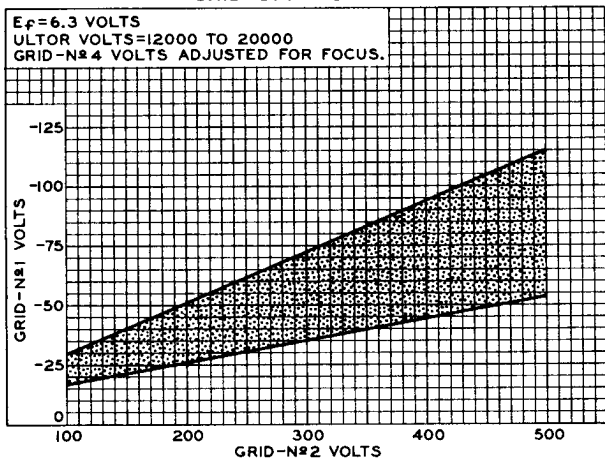

92CS-9919

CATHODE-DRIVE SERVICE

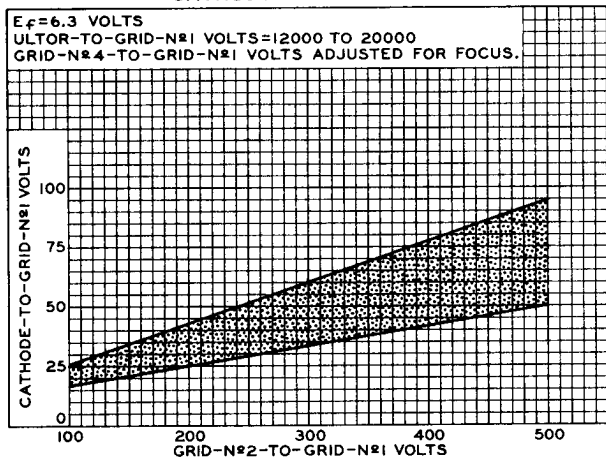

24AUP4



24AUP4 PICTURE TUBE

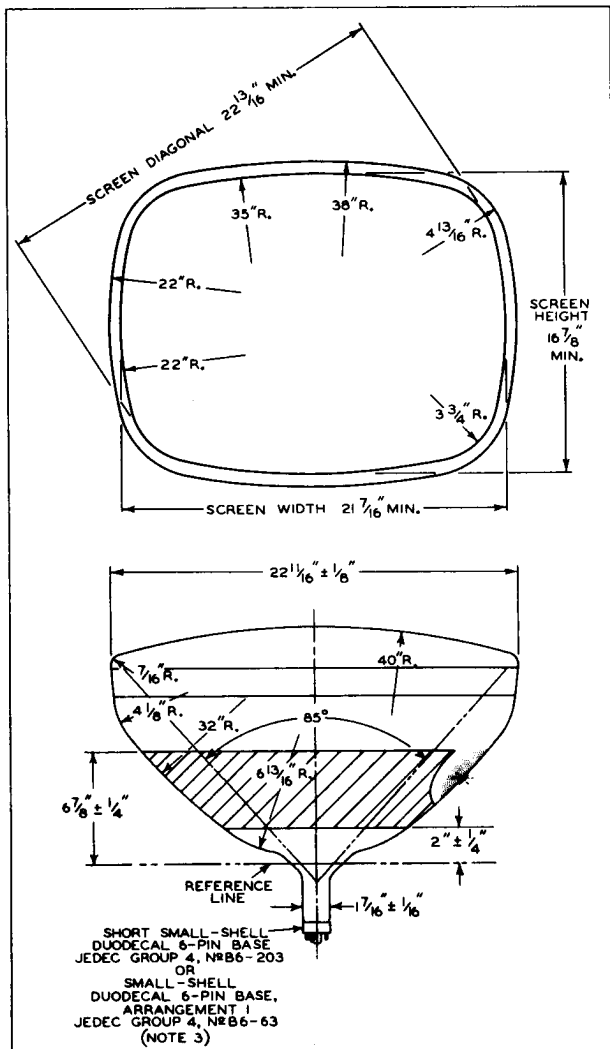



24AUP4

PICTURE TUBE

24AUP4

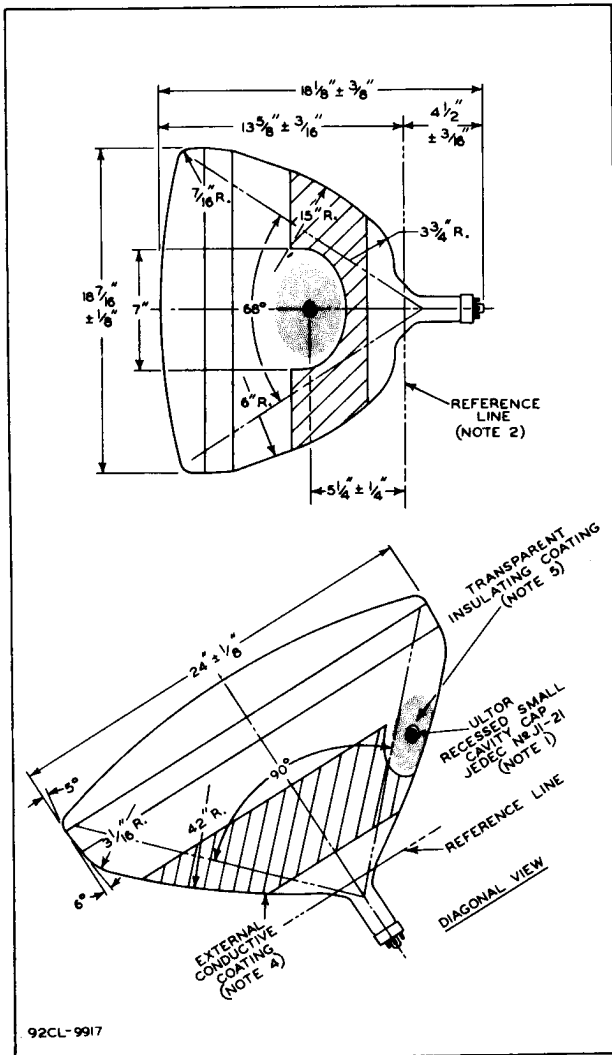

92CL-9917

24AUP4



24AUP4 PICTURE TUBE

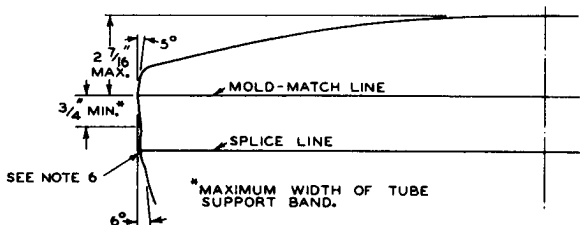

DETAIL OF PANEL

NOTE 1: THE PLANE THROUGH THE TUBE AXIS AND PIN 6 MAY VARY FROM THE PLANE THROUGH THE TUBE AXIS AND ULTOR TERMINAL BY ANGULAR TOLERANCE (MEASURED ABOUT THE TUBE AXIS) OF $\pm 30^\circ$. ULTOR TERMINAL IS ON SAME SIDE AS PIN 6.

NOTE 2: WITH TUBE NECK INSERTED THROUGH FLARED END OF REFERENCE-LINE GAUGE JEDEC No. G-116 (SHOWN AT FRONT OF THIS SECTION) AND WITH TUBE SEATED IN GAUGE, THE REFERENCE LINE IS DETERMINED BY THE INTERSECTION OF THE PLANE CC' OF THE GAUGE WITH THE GLASS FUNNEL.

NOTE 3: SOCKET FOR THIS BASE SHOULD NOT BE RIGIDLY MOUNTED; IT SHOULD HAVE FLEXIBLE LEADS AND BE ALLOWED TO MOVE FREELY. BOTTOM CIRCUMFERENCE OF BASE SHELL WILL FALL WITHIN A CIRCLE CONCENTRIC WITH BULB AXIS AND HAVING A DIAMETER OF 3".

NOTE 4: EXTERNAL CONDUCTIVE COATING MUST BE GROUNDED.

NOTE 5: TO CLEAN THIS AREA, WIPE ONLY WITH SOFT DRY LINT-LESS CLOTH.

NOTE 6: BULGE AT SPLICE-LINE SEAL MAY INCREASE THE INDICATED MAXIMUM VALUE FOR ENVELOPE WIDTH, DIAGONAL, AND HEIGHT BY NOT MORE THAN $1/8$ ", BUT AT ANY POINT AROUND THE SEAL, THE BULGE WILL NOT PROTRUDE MORE THAN $1/16$ " BEYOND THE ENVELOPE SURFACE AT THE MOLD-MATCH LINE.



24AUP4

24AUP4

AVERAGE DRIVE CHARACTERISTICS

CATHODE-DRIVE SERVICE	GRID-DRIVE SERVICE
$E_f = 6.3$ VOLTS	$E_f = 6.3$ VOLTS
ULTOR-TO-GRID-№1 VOLTS = 16000	ULTOR VOLTS = 16000
CATHODE BIASED POSITIVE WITH RESPECT TO GRID №1 TO GIVE FOCUSED RASTER CUTOFF.	GRID №1 BIASED NEGATIVE WITH RESPECT TO CATHODE TO GIVE FOCUSED RASTER CUTOFF.
RASTER FOCUSED AT AVERAGE BRIGHTNESS.	RASTER FOCUSED AT AVERAGE BRIGHTNESS.
RASTER SIZE = 21" x 16"	RASTER SIZE = 21" x 16"

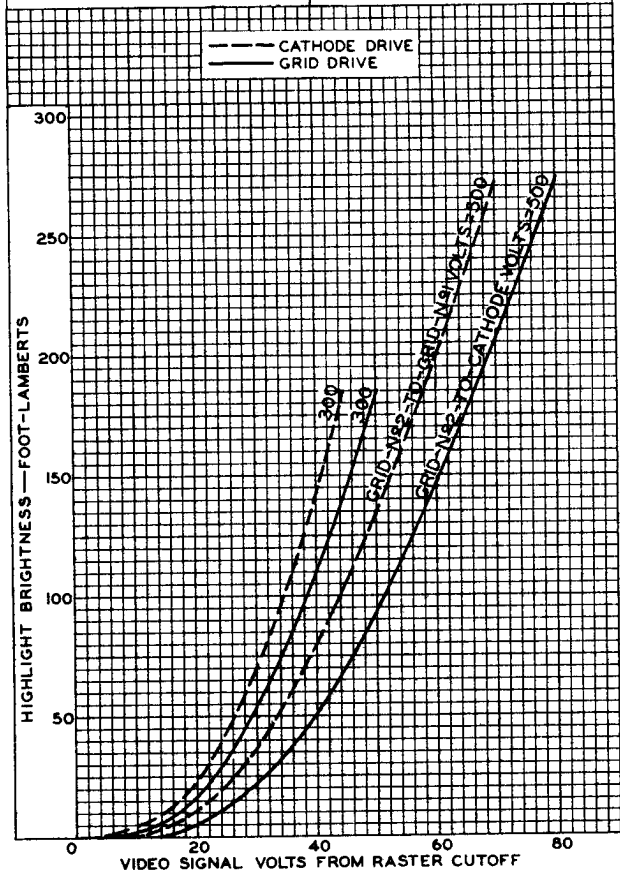

24AUP4



24AUP4

AVERAGE DRIVE CHARACTERISTICS

CATHODE-DRIVE SERVICE
 $E_f = 6.3$ VOLTS
 ULTOR-TO-GRID-N#1 VOLTS =
 12000 TO 20000
 CATHODE BIASED POSITIVE WITH
 RESPECT TO GRID N#1 TO GIVE
 FOCUSED RASTER CUTOFF.

GRID-DRIVE SERVICE
 $E_f = 6.3$ VOLTS
 ULTOR VOLTS = 12000 TO 20000
 GRID N#1 BIASED NEGATIVE, WITH
 RESPECT TO CATHODE TO GIVE
 FOCUSED RASTER CUTOFF.

--- CATHODE DRIVE
 ——— GRID DRIVE

