

# CATHODE RAY TUBES

- OSCILLOGRAPH TUBES
- RADAR DISPLAY TUBES
- MONITOR TUBES
- FLYING SPOT TUBES
- DISPLAY STORAGE TUBE
- ■ VIDICONS

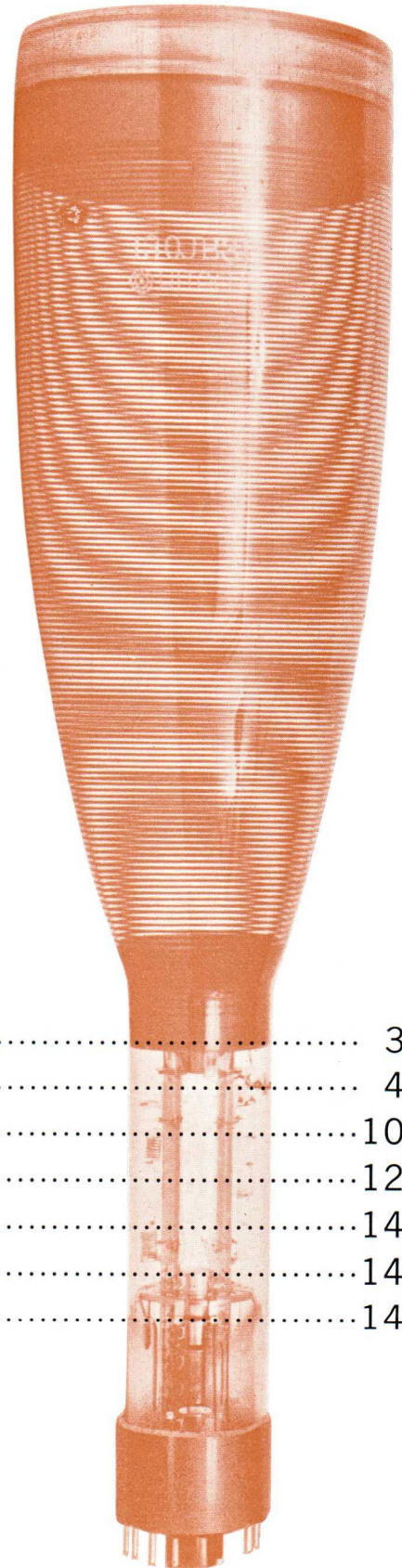

# CATHODE RAY TUBES



## CONTENTS

Standard Phosphors .....	3
Oscillograph Tubes .....	4
Radar Display Tubes .....	10
Monitor Tubes .....	12
Flying Spot Tubes .....	14
Display Storage Tube .....	14
Vidicons .....	14

## INTRODUCTION

This Catalog provides concise technical information on Hitachi Cathode-Ray Tubes. Hitachi has experience of manufacturing electron tubes for past 30 years, and various types of cathode-ray tubes having excellent quality and improved performance are developed and manufactured as the result of cooperation of excellent engineers and scientists working in various factories and laboratories of Hitachi, Ltd.

In this catalog are shown condensed technical data such as Maximum Ratings, Operating Conditions, Base Connections and Dimensional Outlines on various types of Cathode-Ray Tubes. More complete information is available on request to Electron Device and Component Div. Hitachi, Ltd., Marunouchi, Tokyo, Japan.

## STANDARD PHOSPHORS

Designation	Color		Persistence	Application
	Fluorescent	Phosphorescent		
P 1 (B 1)	Green	Green	Medium	Oscilloscopes
P 2 (B 2)	Yellowish-Green	Yellowish-Green	Medium	Oscilloscopes and radar
P 4 (B 4)	White	White	Medium-short	Television Receivers
P 7 (B 7)	White	Yellowish-Green	Long	Radar
P11 (B11)	Blue	Blue	Medium-short	Oscilloscopes for visual or photographic observation
P12 (B12)	Orange	Orange	Long	Radar
P15 (B15)	Green	Green	Very short	Flying spot scanner
P16 (B16)	Bluish purple	Bluish purple	Very short	Flying spot scanner

# OSCILLOGRAPH TUBES

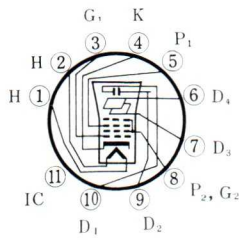

**1EP-**

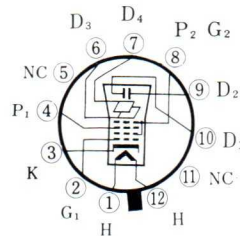

**2BP- • 50HB-**

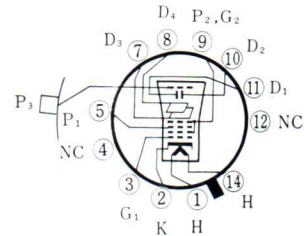

**3FP-A • 3JP-**

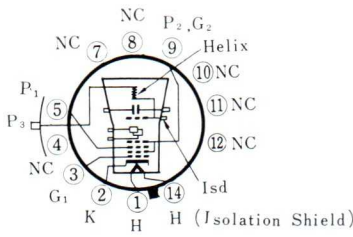

**3BHP-**

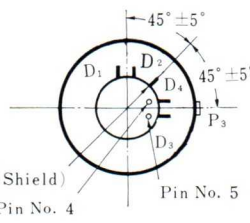

**3KP- • 3KP-(F)**

Type	Heater		Dimensional Outline		Base & Cap	Direct Interelectrode Capacitances			Screen		Maximum Ratings				
	Voltage (V)	Current (A)	Overall Length (inch)	Greatest Diameter of Bulb (inch)		D <sub>1</sub> to D <sub>2</sub> (pF)	D <sub>3</sub> to D <sub>4</sub> (pF)	G <sub>1</sub> to All other Electrode (pF)	Minimum Useful Diameter (inch)	Phosphor Numbers	Anode No. 3 (Post Ultor) Voltage (V)	Anode No. 2 (Ultor) Voltage (V)	Anode No. 1 Voltage for Focus (V)	Grid No. 1 Voltage (V)	Ratio of Post Ultor Voltage to Ultor Voltage
1EP-	6.3 ± 10%	0.6	4 <sup>1</sup> / <sub>16</sub> Max	1 <sup>1</sup> / <sub>4</sub> ± 1 <sup>1</sup> / <sub>16</sub>	E11-22	1.7	0.6	6.5	1 <sup>1</sup> / <sub>16</sub>	P1	—	1,500 (300min)	1,200	-200	—
2BP-	6.3 ± 10%	0.6	7 <sup>5</sup> / <sub>8</sub> ± 3 <sup>3</sup> / <sub>16</sub>	2 ± 1 <sup>1</sup> / <sub>16</sub>	B12-43	2	2	8	1 <sup>3</sup> / <sub>4</sub>	P1	—	2,500	1,000	-200	—
50HB-	6.3 ± 10%	0.3	6 <sup>1</sup> / <sub>16</sub> ± 3 <sup>3</sup> / <sub>16</sub>	2 ± 1 <sup>1</sup> / <sub>16</sub>	B12-43	1.5	1.5	6	1 <sup>3</sup> / <sub>4</sub>	B1	—	1,500	1,000	-200	—
3BHP-	6.3 ± 10%	0.3	13 <sup>3</sup> / <sub>8</sub> ± 3 <sup>3</sup> / <sub>8</sub>	3 ± 1 <sup>1</sup> / <sub>16</sub>	B12-37 J1-21 Pins	2.8	1.5	7.2	2 <sup>5</sup> / <sub>8</sub>	P1 P2 P7 P11	7,000	2,000	1,000	-200	6
3FP-A	6.3 ± 10%	0.6	10 ± 1 <sup>1</sup> / <sub>4</sub>	3 ± 1 <sup>1</sup> / <sub>16</sub>	B12-37 J1-22	2.5	2	8	2 <sup>3</sup> / <sub>4</sub>	P1 P7 P11	4,000	2,000	1,000	-125	2.3
3JP-	6.3 ± 10%	0.6	10 ± 1 <sup>1</sup> / <sub>4</sub>	3 ± 1 <sup>1</sup> / <sub>16</sub>	B12-37 J1-22	2.5	2	8	2 <sup>3</sup> / <sub>4</sub>	P1 P7 P11	4,000	2,000	1,000	-125	2.3
3KP- 3KP-(F)	6.3 ± 10%	0.6	11 <sup>1</sup> / <sub>2</sub> ± 1 <sup>1</sup> / <sub>4</sub>	3 ± 1 <sup>1</sup> / <sub>16</sub>	B11-66	2.5	2.5	8	2 <sup>3</sup> / <sub>4</sub> 2 <sup>5</sup> / <sub>8</sub>	P1 P7 P11	—	2,500	1,000	-200	—

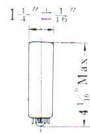

**1EP1**

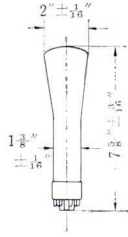

**2BP1**

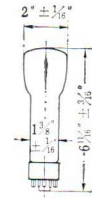

**50HB1**

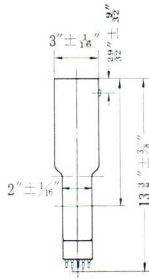

**3BHP-**

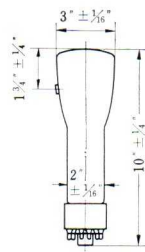

**3FP-A • 3JP-**

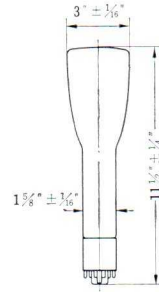

**3KP-**

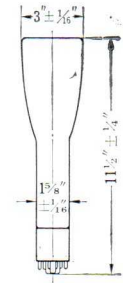

**3KP-(F)**

Equipment Design Ranges			Operating Conditions						
Grid No. 3 Voltage (V)	Deflection Factors		Anode No. 3 (Post Ultor) Voltage (V)	Anode No. 2 (Ultor) Voltage (V)	Anode No. 1 Voltage for Focus (V)	Pattern Adjustment Electrode Voltage Deflection Plate Shield Voltage	Grid No. 1 Voltage for Visual Cut Off (V)	Deflection Factors	
	D <sub>1</sub> to D <sub>2</sub> (Vdc/in./kV of Eb <sub>2</sub> )	D <sub>3</sub> to D <sub>4</sub> (Vdc/in./kV of Eb <sub>2</sub> )						D <sub>1</sub> to D <sub>2</sub> (Vdc/inch)	D <sub>3</sub> to D <sub>4</sub> (Vdc/inch)
Eb <sub>2</sub> × 10~30%	210~310	240~350	—	500	50~150	—	-7~-23	105~155	120~175
			—	1,000	100~300	—	-14~-46	210~310	240~350
Eb <sub>2</sub> × 15~28%	115~155	74~100	—	1,000	150~280	—	-67.5 max	115~155	74~100
			—	2,000	300~560	—	-135 max	230~310	148~200
Eb <sub>2</sub> × 14~32%	264 max	230 max	—	500	70~160	—	-34 max	132 max	115 max
			—	1,000	140~320	—	-67.5 max	264 max	230 max
Eb <sub>2</sub> × 14~26%	65.2~85.6 (Eb <sub>3</sub> = 6Eb <sub>2</sub> )	23.8~34.3	6,000	1,000	140~260	950~1,050	-32~-55	65.2~85.6	23.8~34.3
			3,000	500	70~130	475~525	-16~-27.5	32.6~42.8	11.9~17.2
Eb <sub>2</sub> × 20~34.5%	106~144 (Eb <sub>3</sub> = 2Eb <sub>2</sub> )	76~104	4,000	2,000	400~690	—	-30~-90	212~288	153~207
			2,000	2,000	400~690	—	-30~-90	136~184	100~136
Eb <sub>2</sub> × 20~34.5%	85~115 (Eb <sub>3</sub> = 2Eb <sub>2</sub> )	62.5~85	3,000	1,500	300~515	—	-23~-67	127~173	94~128
			4,000	2,000	400~690	—	-30~-90	170~230	125~170
			—	1,000	160~300	—	-45 max	50~68	38~52
Eb <sub>2</sub> × 16~30%	50~68	38~52	—	2,000	320~600	—	-90 max	100~136	76~104

Ⓐ Focusing method and deflection method are electrostatic.

# OSCILLOGRAPH TUBES

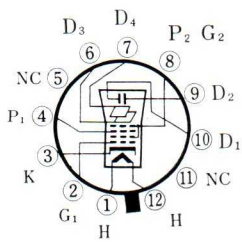

**3RP-3RP-A**

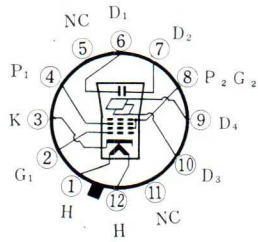

**3WP-**

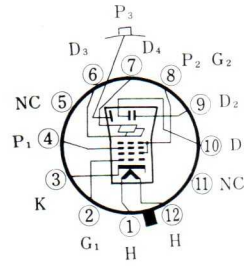

**80CB-**

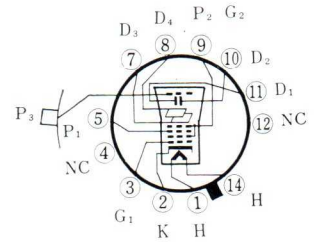

**5ABP-5CP-A**

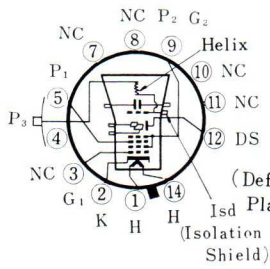

**5BHP-5CBP-**

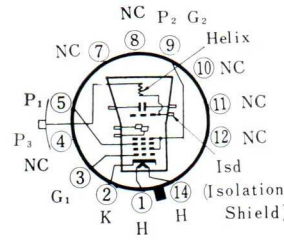
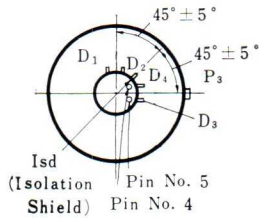

**5CAP-**

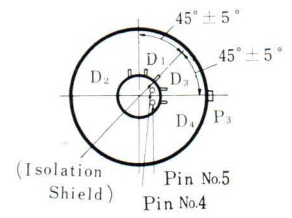

Type	Heater		Dimensional Outline		Base & Cap	Direct Interelectrode Capacitances			Screen		Maximum Ratings				
	Voltage (V)	Current (A)	Overall Length (inch)	Greatest Diameter of Bulb (inch)		D <sub>1</sub> to D <sub>2</sub> (pF)	D <sub>3</sub> to D <sub>4</sub> (pF)	G <sub>1</sub> to All Other Electrode (pF)	Minimum Useful Diameter (inch)	Phosphor Numbers	Anode No. 3 (Post Ultor) Voltage (V)	Anode No. 2 (Ultor) Voltage (V)	Anode No. 1 Voltage for Focus (V)	Grid No. 1 Voltage (V)	Ratio of Post Ultor Voltage to Ultor Voltage
3RP-3RP-A	6.3 ± 10%	0.6	9 1/8 ± 1/4	3 ± 1/16	B12-43	2	2	8	2 3/4 ± 2/8	P1 P7 P11	—	2,500	1,000	-200	—
3WP-	6.3 ± 10%	0.6	11 1/2 ± 1/8	3 ± 1/16	B12-43	2.8	1.8	7.8	2 3/4	P1 P2 P7 P11	—	2,500	1,000	-200	—
80CB-	6.3 ± 10%	0.3	9 17/32 ± 1/4	3 1/4 ± 1/8	B12-43 J1-21	2	2	8	1 3/4 × 2 3/8	B1	4,000	2,000	1,000	-200	2
5ABP-	6.3 ± 10%	0.6	16 3/4 ± 3/8	5 1/4 ± 3/32	B12-37 J1-22	2.5	1.3	8	4 9/16	P1 P7 P11	6,000	2,600	1,000	-200	2.3
5BHP-	6.3 ± 10%	0.6	18 1/4 ± 3/16	5 1/4 ± 3/32	B12-37 J1-21 Pins	1.9	1.5	6.4	4 1/2	P1 P2 P7 P11	12,000	2,000	800	-200	6
5CAP-	6.3 ± 10%	0.6	17 1/2 ± 3/16	5 1/4 ± 3/32	B12-37 J1-21 Pins	1.9	1.4	7.0	4 1/2	P1 P2 P7 P11	6,000	2,000	800	-200	3.3
5CP-A	6.3 ± 10%	0.6	16 3/4 ± 3/8	5 1/4 ± 3/32	B12-37 J1-22	2	2	8	4 1/2	P1 P7 P11	4,000	2,000	1,000	-200	2.3
5CBP-	6.3 ± 10%	0.6	18 1/4 ± 3/16	5 1/4 ± 3/32	B12-37 J1-21 Pins	1.9	1.4	7	4 1/2	P1 P2 P7 P11	6,000	2,000	800	-200	3

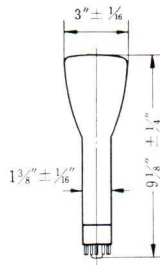

**3RP-**

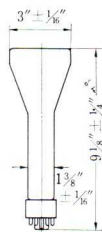

**3RP-A**

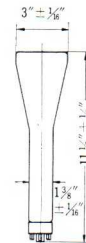

**3WP-**

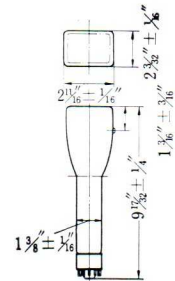

**80CB-**

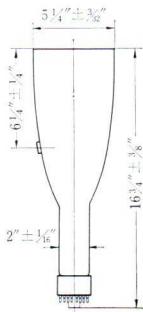

**5ABP-**

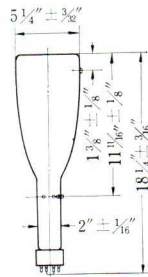

**5BHP- • 5CBP-**

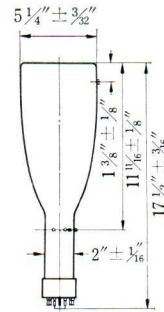

**5CAP-**

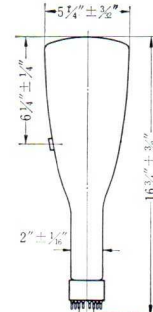

**5CP-A**

Equipment Design Ranges			Operating Conditions						
Grid No. 3 Voltage (V)	Deflection Factors		Anode No. 3 (Post Ultor) Voltage (V)	Anode No. 2 (Ultror) Voltage (V)	Anode No. 1 Voltage for Focus (V)	Pattern Adjustment Electrode Voltage Deflection Plate Shield Voltage	Grid No. 1 Voltage for Visual Cut Off (V)	Deflection Factors	
	D <sub>1</sub> to D <sub>2</sub> (Vdc/in./kV of Eb <sub>2</sub> )	D <sub>3</sub> to D <sub>4</sub> (Vdc/in./kV of Eb <sub>2</sub> )						D <sub>1</sub> to D <sub>2</sub> (Vdc/inch)	D <sub>3</sub> to D <sub>4</sub> (Vdc/inch)
Eb <sub>2</sub> × 16.5~31%	73~99	52~70	—	1,000	165~310	—	-67.5 max	73~99	52~70
			—	2,000	330~620	—	-130 max	146~198	104~140
Eb <sub>2</sub> × 16.5~31%	41.5~50.5	28.5~35	—	1,000	165~310	—	-30~-50	41.5~50.5	28.5~35
			—	1,500	247~465	—	-45~-75	62.3~75.8	42.8~52.5
			—	2,000	330~620	—	-60~-100	83~101	57~70
Eb <sub>2</sub> × 15~35	(Eb <sub>3</sub> = 2Eb <sub>2</sub> ) 73.6~100	53.4~72.6	1,000	500	75~175	—	-20~-40	36.8~50	26.7~36.3
			2,000	2,000	400~685	—	-52~-87	43~58	29~39
			3,000	1,500	300~515	—	-39~-65	40~54	27~36
Eb <sub>2</sub> × 20~34.5%	(Eb <sub>3</sub> = 2Eb <sub>2</sub> ) 26.5~36	18~24	4,000	2,000	400~685	—	-52~-87	53~72	36~48
			10,000	1,670	180~590	1,580~1,760	-50~-80	70~85	15.0~18.3
			6,000	1,850	225~670	1,720~1,980	-60~-85	48.2~61.0	22.6~28
Eb <sub>2</sub> × 18.7~34.5%	(Eb <sub>3</sub> = 2Eb <sub>2</sub> ) 39~53	33~45	2,000	2,000	375~690	—	-30~-90	62~84	54~74
			3,000	1,500	280~515	—	-22.5~-67.5	59~80	50~68
			4,000	2,000	375~690	—	-30~-90	78~106	66~90
Eb <sub>2</sub> × 10.0~29.8%	(Eb <sub>3</sub> = 2.1Eb <sub>2</sub> ) 25.4~30.8	8~10	4,000	1,330	130~395	1,260~1,400	-43~-60	38.3~46.8	11.9~15.3
			4,000	1,600	160~475	1,520~1,680	-52~-72	43.1~52.4	13.4~17
			4,000	1,900	190~565	1,800~2,000	-62~-85	48.2~58.4	15.2~19.1

ⓑ (F) in Type No. indicate flat face.

# OSCILLOGRAPH TUBES

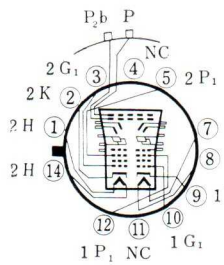

**5SP-A**

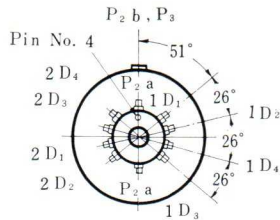

**5UP- • 5UP-(F)**

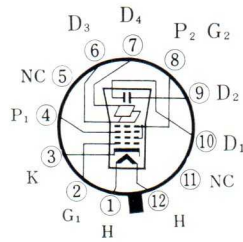

**5XP-A • 5XP-B**

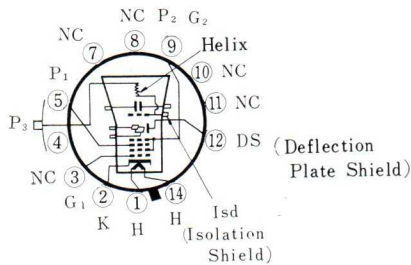
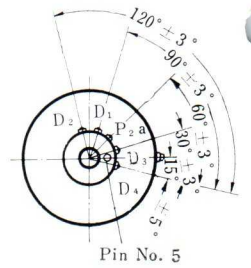

**130CB-**

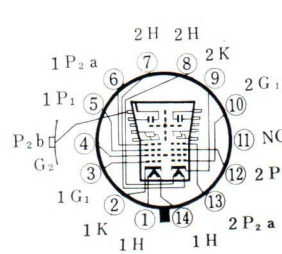
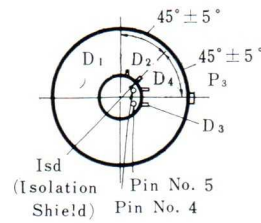

**130DB-**

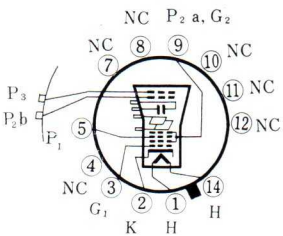
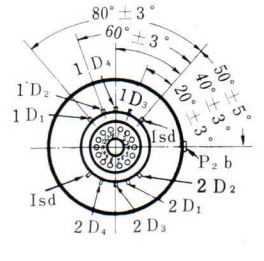

**130HB-**

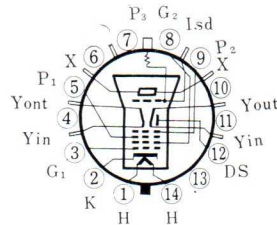
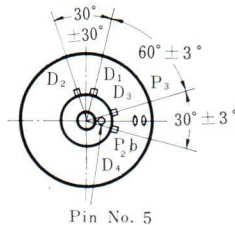

**130JB-**

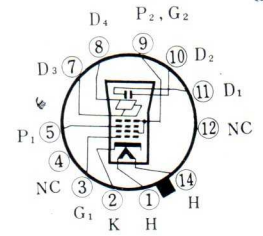
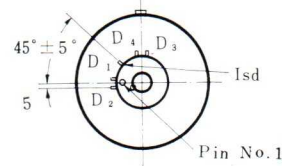

**7VP-(F)**

Type	Heater		Dimensional Outline		Base & Cap	Direct Interelectrode Capacitances			Screen		Maximum Ratings				
	Voltage (V)	Current (A)	Overall Length (inch)	Greatest Diameter of Bulb (inch)		D1 to D2 (pF)	D3 to D4 (pF)	G1 to All Other Electrode (pF)	Minimum Useful Diameter (inch)	Phosphor Numbers	Anode No. 3 (Post Ultor) Voltage (V)	Anode No. 2 (Ultor) Voltage (V)	Anode No. 1 Voltage for Focus (V)	Grid No. 1 Voltage (V)	Ratio of Post Ultor Voltage to Ultor Voltage
5SP-A	6.3 ± 10%	0.6	18 1/4 ± 1/4	5 1/4 ± 3/32	B12-37 J1-22 C1-2	2 max	2.3 max	6.6 max	4 9/16	P1 P7 P11	7,500	2,500	1,000	-200	3
5UP- 5UP-(F)	6.3 ± 10%	0.6	14 3/4 ± 3/8	5 1/4 ± 3/32	B12-43	2.5	2.5	8	4 1/2	P1 P7 P11	—	2,500	1,000	-200	—
5XP-A 5XP-B	6.3 ± 10%	0.6	17 5/8 ± 1/4	5 1/4 ± 3/32	B12-37 J1-22 J1-25	1.7	1.7	5	4 1/2	P1 P2 P7 P11	25,500	3,650	1,550	-200	10
130CB-	6.3 ± 10%	0.3	18 1/4 ± 3/16	5 1/4 ± 3/32	B12-37 J1-21 Pins	2.5	1.5	6.4	4 1/2	B1 B2 B7 B11	6,000	2,000	800	-200	3
130DB-	6.3 ± 10%	0.6	19 3/32 ± 3/8	5 1/4 ± 3/32	B14-38 J1-21 Pins	3.3	1.6	7.4	4 9/16	B1 B2 B7 B11	—	3,000	1,000	-200	—
130HB-	6.3 ± 10%	0.6	16 3/4 ± 3/8	5 1/4 ± 3/32	B12-37 J1-22 Pins	2.3	1.1	8	4 9/16	B1 B2 B7 B11	6,000	2,600	1,000	-200	2.3
130JB-	6.3 ± 10%	0.6	20 15/16 ± 3/16	5 1/4 ± 1/16	B14-38	2.5	1.9	6.4	4 1/2	B1 B2 B31	12,000	2,000	1,000	-200	6
7VP-(F)	6.3 ± 10%	0.6	14 1/2 ± 3/8	7 ± 1/8	B12-37	3	2	6	6	P1 P7 P11	—	4,000	2,000	-200	—



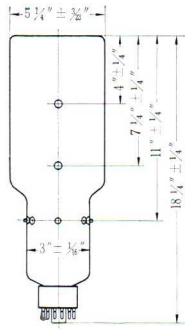

5SP-A

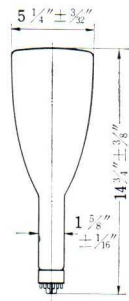

5UP-

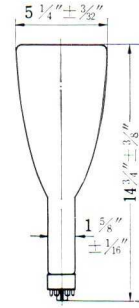

5UP-(F)

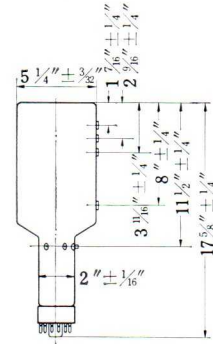

5XP-A • 5XP-B

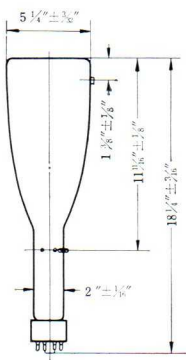

130CB-

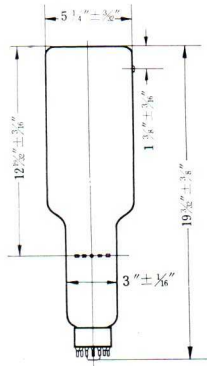

130DB-

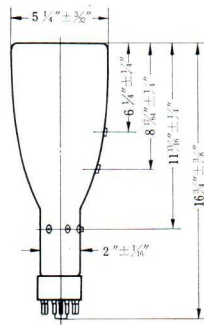

130HB-

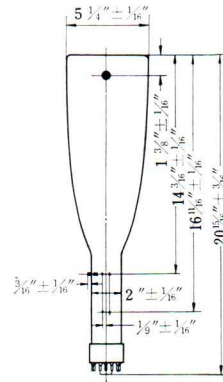

130JB-

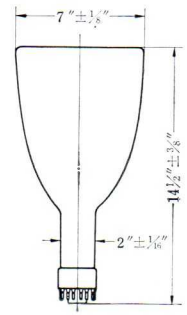

7VP-(F)

Equipment Design Ranges			Operating Conditions						
Grid No. 3 Voltage (V)	Deflection Factors		Anode No. 3 (Post Ultor) Voltage (V)	Anode No. 2 (Ultor) Voltage (V)	Anode No. 1 Voltage for Focus (V)	Pattern Adjustment Electrode Voltage Deflection Plate Shield Voltage	Grid No. 1 Voltage for Visual Cut Off (V)	Deflection Factors	
	D <sub>1</sub> to D <sub>2</sub> (Vdc/in./kV of Eb <sub>2</sub> )	D <sub>3</sub> to D <sub>4</sub> (Vdc/in./kV of Eb <sub>2</sub> )						D <sub>1</sub> to D <sub>2</sub> (Vdc/inch)	D <sub>3</sub> to D <sub>4</sub> (Vdc/inch)
Eb <sub>2</sub> × 18.1~34.8%	(Eb <sub>3</sub> = 2Eb <sub>2</sub> )		3,000	1,500	272~521	—	-34~-56	62~76	53~65
	41.5~50.5	35~43	4,000	2,000	363~695	—	-45~-75	83~101	70~86
Eb <sub>2</sub> × 17~32%	28~38.5	23~31	—	1,500	260~480	—	-67.5 max	42~57.8	34.5~46.5
			—	2,000	340~640	—	-90 max	56~77	46~62
Eb <sub>2</sub> × 18.1~34.8%	(Eb <sub>3</sub> = Eb <sub>2</sub> )		8,000	2,000	362~695	—	-45~-75	108~132	34.5~43.2
	38~46	12~15	12,000	2,000	362~695	—	-45~-75	130~159	42~52
Eb <sub>2</sub> × 9.8~30%	(Eb <sub>3</sub> = 3Eb <sub>2</sub> )		6,000	2,000	195~600	1,860~2,140	-52~-85	41.9~57.4	15.2~21.1
	20.8~28.8	7.6~10.7	4,000	1,330	130~400	1,240~1,420	-35~-56	27.9~38.1	10.1~14.0
Eb <sub>2</sub> × 14~26%	13.5~18.6	9.3~12.7	—	3,000	420~780	2,850~3,150	-50~-80	40.6~55.9	27.9~38.1
Eb <sub>2</sub> × 20~34.5%	(Eb <sub>3</sub> = 2Eb <sub>2</sub> )		2,000	2,000	400~690	—	-52~-87	43~58	29~39
	26.5~36	18~24	3,000	1,500	300~515	—	-39~-65	40~54	27~36
			4,000	2,000	400~690	—	-52~-87	53~72	36~48
Eb <sub>2</sub> × 12~40%	45.8~55.8	11.7~14.2	10,000	1,670	200~600	1,580~1,760	-40~-70	50.8	14
Eb <sub>2</sub> × 27~40%	31~41	25~34	—	1,500	400~600	—	-42 max	47~62	38~51
			—	3,000	800~1,200	—	-84 max	93~123	75~102

① 5SP-A, 130DB- are dual beam oscilograph tubes.

(F) in Type No. indicates flat face. As to 5XP-, A indicates none metal-backed, screen and B indicates metal-backed.

# RADAR DISPLAY TUBES

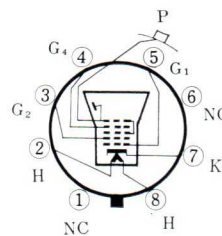

**5AHP7A**

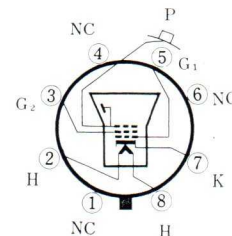

**5FP7A(M)**  
**7BP7A(M)**  
**12DP7A(M)**

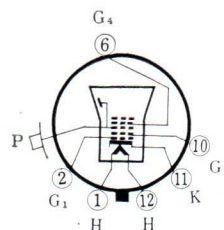

**7ABP7A**  
**10WP7A**  
**16AKP7**

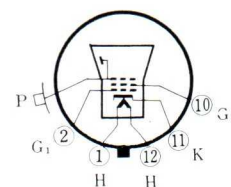

**7MP7(M)**  
**10KP7(M)**  
**12SP7B**

Type	Heater		Focusing Method	Deflection Method	Dimensional Outline		Base	Cap	Deflection Angle (°)
	Voltage (V)	Current (A)			Overall Length (inch)	Greatest Diameter of Bulb (inch)			
5AHP7A	6.3±10%	0.6	Electrostatic	Magnetic	11 1/8 ± 1/4	4 15/16 ± 3/32	B8-11	J1-22	53
5FP7A(M)	6.3±10%	0.6	Magnetic	Magnetic	11 1/8 ± 1/4	4 15/16 ± 3/32	B8-11	J1-22	53
7ABP7A	6.3±10%	0.6	Electrostatic	Magnetic	13 1/4 ± 1/4	7 3/16 ± 1/8	B6-63	J1-21	50
7BP7A(M)	6.3±10%	0.6	Magnetic	Magnetic	13 1/4 ± 3/8	7 ± 1/8	B8-11	J1-22	53
7MP7(M)	6.3±10%	0.6	Magnetic	Magnetic	12 3/4 ± 3/4	7 3/8 ± 1/8	B5-57	J1-21	50
10KP7(M)	6.3±10%	0.6	Magnetic	Magnetic	17 5/8 ± 3/8	10 1/2 ± 1/16	B5-57	J1-21	50
10WP7A	6.3±10%	0.6	Electrostatic	Magnetic	16 15/16 ± 3/8	10 1/2 ± 1/8	B6-63	J1-21	50
12DP7A(M)	6.3±10%	0.6	Magnetic	Magnetic	19 5/8 ± 1/2	12 ± 3/16	B8-11	C1-5	50
12SP7B	6.3±10%	0.6	Magnetic	Magnetic	18 3/4 ± 3/8	12 7/16 ± 1/16	B5-57	J1-21	50
16AKP7	6.3±10%	0.6	Electrostatic	Magnetic	22 1/16 ± 3/8	15 7/8 ± 1/8	B7-51	J1-21	53

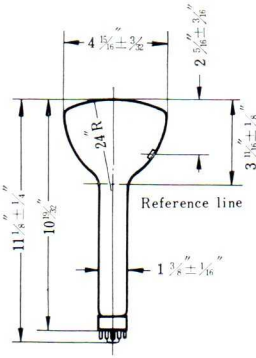

**5AHP7A • 5EP7A(M)**

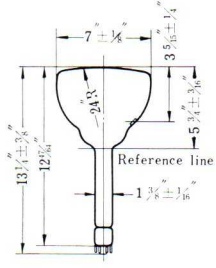

**7BP7A(M)**

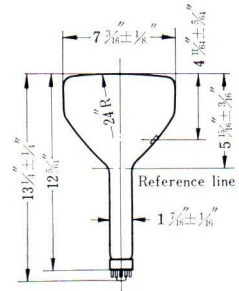

**7ABP7A**

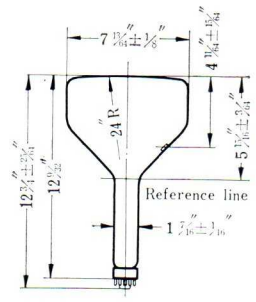

**7MP7(M)**

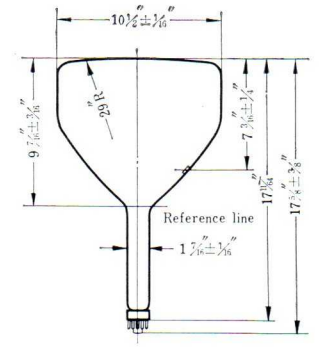

**10KP7(M)**

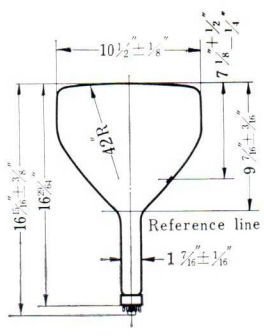

**10WP7A**

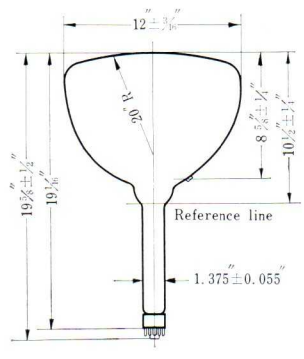

**12DP7A(M)**

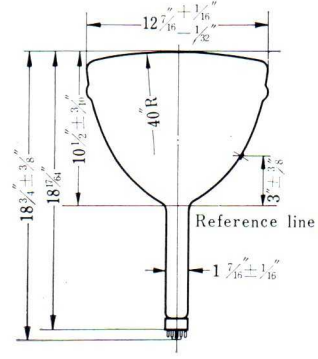

**12SP7B**

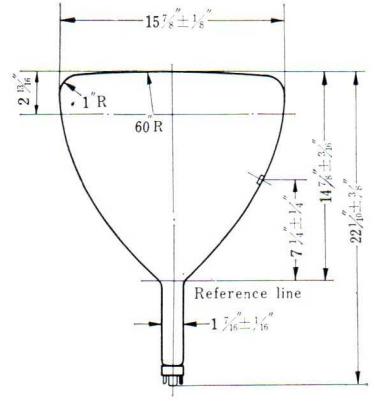

**16AKP7**

Direct Interelectrode Capacitance		Minimum Useful Screen Diameter (inch)	Grid No. 1 Circuit Resistance (M.Ω)	Maximum Ratings				Operating Conditions				
Grid No. 1 to All Other Electrodes (pF)	Cathode to All Other Electrodes (pF)			Anode (Ultor) Voltage (V)	Focusing Electrode Voltage (V)	Grid No. 2 Voltage (V)	Grid No. 1 Voltage (V)	Anode (Ultor) Voltage (V)	Focusing Voltage (V)	Grid No. 2 Voltage (V)	Grid No. 1 Voltage (V)	Focusing Field (AT)
6	5	4 1/4	1.5	10,000	-500 ~ +1,000	700	-180	7,000	300	-33 ~ -77	0 ~ 250	—
8	5	4 1/4	1.5	8,000	—	700	-165	7,000	250	-25 ~ -70	—	500
6	5	6	1.5	10,000	-500 ~ +1,000	700	-180	7,000	300	-28 ~ -72	0 ~ 300	—
8.5	5	6	1.5	8,000	—	700	-165	7,000	250	-25 ~ -70	—	400
6	5	5	1.5	8,000	—	700	-165	7,000	250	-27 ~ -63	—	500
6	5	9	1.5	10,000	—	700	-165	9,000	250	-27 ~ -63	—	620
6	5	9	1.5	12,000	-410 ~ +820	550	-180	10,000	300	-28 ~ -72	0 ~ 300	—
9	6	10	1.5	10,000	—	700	-165	7,000	250	-25 ~ -70	—	500
6	5	11	1.5	10,000	—	400	-165	9,000	250	-27 ~ -63	—	500
9	7	14 5/8	1.5	14,000	-500 ~ +1,000	450	-180	12,000	300	-35 ~ -75	-300 ~ +250	—

Ⓔ In general, the ultor voltage should not be less than 6,000 V.

# MONITOR TUBES

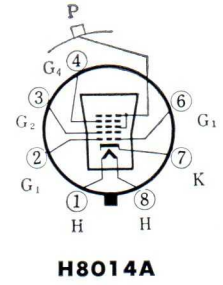
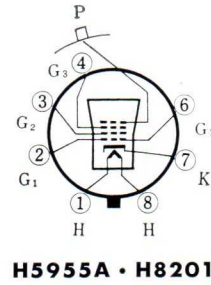
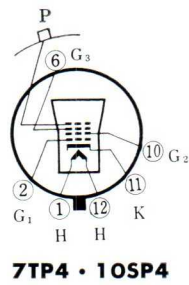
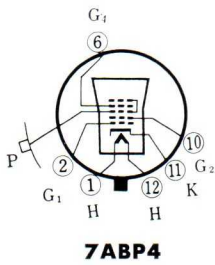
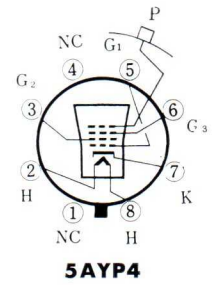
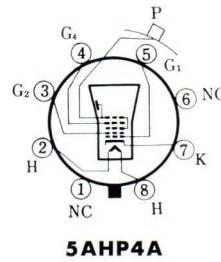
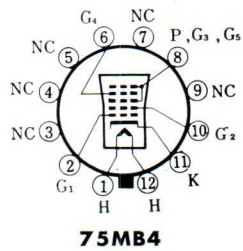

Type	Heater		Focusing Method	Deflection Method	Dimensional Outline		Base	Cap	Deflection Angle (°)
	Voltage (V)	Current (A)			Overall Length (inch)	Greatest Diameter of Bulb (inch)			
75MB4	6.3 ± 10%	0.3	Electrostatic	Magnetic	9 1/4 ± 1/4	3 ± 1/16	B12-43 B12-207	—	30
5AHP4A	6.3 ± 10%	0.6	Electrostatic	Magnetic	11 1/8 ± 1/4	4 5/16 ± 3/32	B8-11	J1-22	53
5AYP4	6.3 ± 10%	0.6	Electrostatic	Magnetic	11 9/16 ± 3/8	4 5/16 ± 3/32	B8-65	J1-22	53
7ABP4	6.3 ± 10%	0.6	Electrostatic	Magnetic	13 1/4 ± 1/4	7 3/16 ± 1/8	B6-63	J1-21	50
7TP4	6.3 ± 10%	0.6	Electrostatic	Magnetic	13 1/8 ± 3/8	7 3/16 ± 1/8	B6-63	J1-21	50
10SP4	6.3 ± 10%	0.6	Electrostatic	Magnetic	16 5/8 ± 3/8	10 1/2 ± 1/8	B6-63	J1-21	50
H5955A	6.3 ± 10%	0.3	Electrostatic	Magnetic	7 7/8 ± 5/16	5 ± 1/8	B7-208	J1-21	70
H8014A	6.3 ± 10%	0.3	Electrostatic	Magnetic	7 9/16 ± 5/16	5 ± 1/8	B7-208	J1-21	70
H8201	12.6 ± 10%	0.15	Electrostatic	Magnetic	9 7/8 ± 3/8	8 7/16 ± 1/8	B7-208	J1-21	90

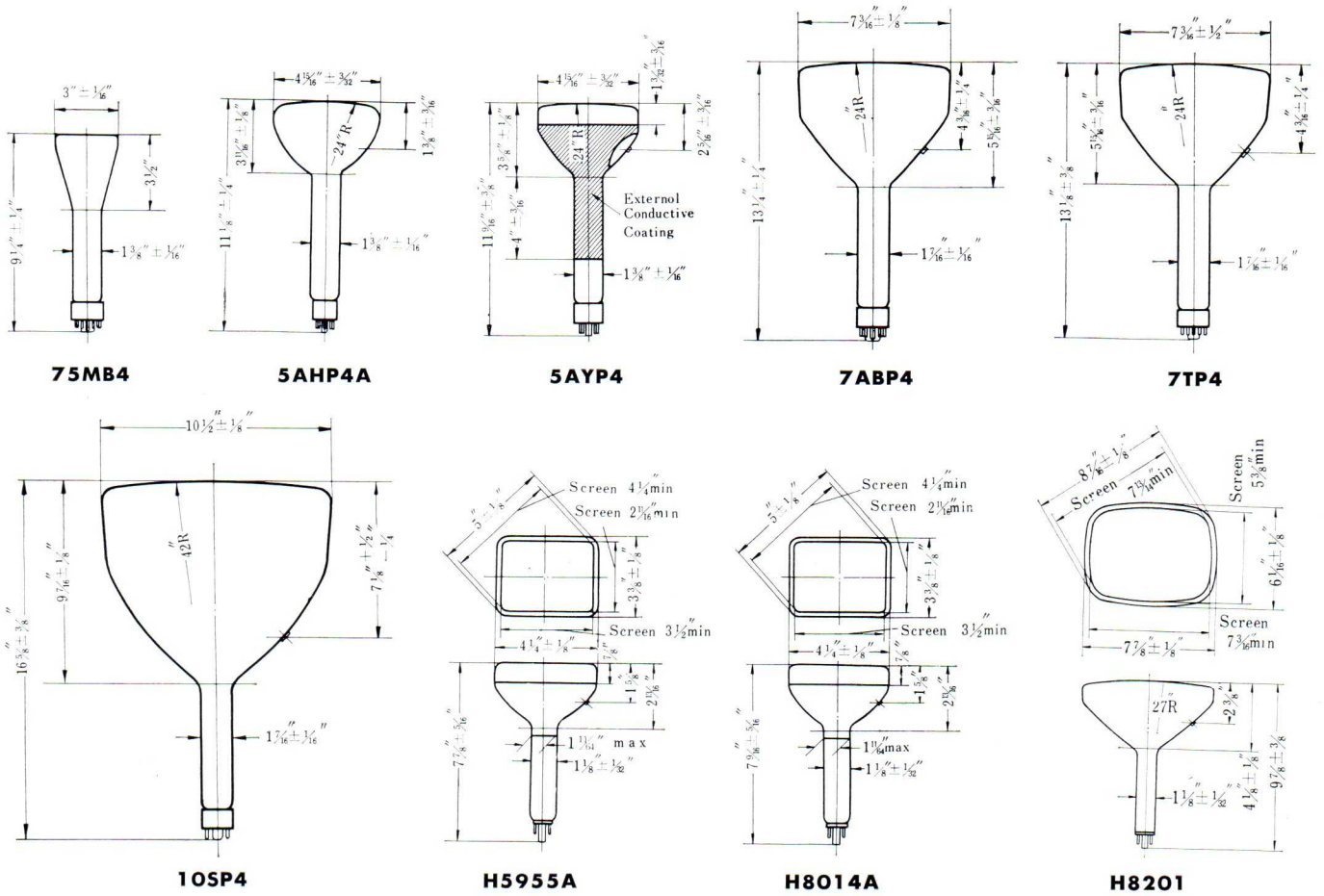

Direct Interelectrode Capacitance		Minimum Useful Screen Diameter (inch)	Grid No. 1 Circuit Resistance (MΩ)	Maximum Ratings				Operating Condition			
Grid No. 1 to All Other Electrodes (pF)	Cathode to All Other Electrodes (pF)			Anode (Ultor) Voltage (V)	Focusing Electrode Voltage (V)	Grid No. 2 Voltage (V)	Grid No. 1 Voltage (V)	Anode (Ultor) Voltage (V)	Focusing Voltage (V)	Grid No. 2 Voltage (V)	Grid No. 1 Voltage (V)
6	5	2 $\frac{5}{8}$	1.5	3,000	500	400	-115	2,500	0~250	300	-33~-77
6	5	4 $\frac{1}{4}$	1.5	10,000	-500~+1,000	700	-180	7,000	0~300	300	-33~-77
6	5	4 $\frac{1}{4}$	1.5	10,000	1,500	410	-115	10,000	980~1,410	300	-33~-77
6	5	6	1.5	10,000	-500~+1,000	700	-180	7,000	0~300	300	-33~-77
6	5	6	1.5	12,000	2,000	410	-115	10,000	1,160~1,560	200	-22~-52
6	5	9 $\frac{3}{8}$	1.5	14,000	3,000	410	-115	12,000	1,400~1,900	200	-22~-52
6	5	4 $\frac{1}{4}$	1.5	10,000	2,000	410	-125	10,000	1,190~1,610	200	-25~-54
6	5	4 $\frac{1}{4}$	1.5	11,000	1,000	500	-125	9,000	50~350	300	-33~-77
6	5	7 $\frac{13}{16}$	1.5	11,000	2,000	500	-125	8,000	984~1,320	150	-20~-40

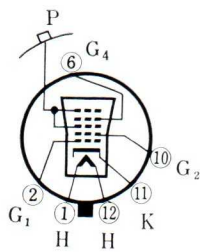

**H59401**

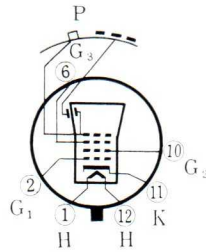

**5CNP16**

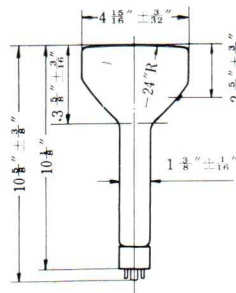

**H59401**

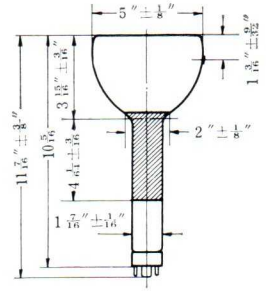

**5CNP16**

## FLYING SPOT TUBES

Type	Heater		Focusing Method	Deflection Method	Dimensional Outline		Base	Cap	Deflection Angle (°)
	Voltage (V)	Current (A)			Overall Length (inch)	Greatest Diameter of Bulb (inch)			
H59401	6.3	0.6	Electrostatic	Magnetic	10 <sup>5</sup> / <sub>8</sub> ± <sup>3</sup> / <sub>8</sub>	4 <sup>15</sup> / <sub>16</sub> ± <sup>3</sup> / <sub>32</sub>	B6-63	J1-22	50
5CNP16	6.3	0.6	Electrostatic	Magnetic	11 <sup>7</sup> / <sub>16</sub> ± <sup>3</sup> / <sub>8</sub>	5 ± <sup>1</sup> / <sub>8</sub>	B6-63	J1-21	50

## DISPLAY STORAGE TUBE

Type	Heater		Focusing Method	Deflection Method	Writing Method	Viewing Method	Dimensional Outline		Base	Maximum Viewing			
	Voltage (V)	Current (A)					Overall Length (inch)	Greatest Diameter of Bulb (inch)		Screen Voltage (V)	Backplate Voltage (V)	Grid No. 5 Voltage (V)	Grid No. 4 Voltage (V)
	7448	★ 1 6.3 ± 10%					0.6	None		None	Non equilibrium		
	★ 2 6.3 ± 10%	0.6	Electrostatic	Electrostatic		Flood beam	13.64	5.25	B14-38	7,000	2	210	50~150

## VIDICONS

Type	Heater		Focusing Method	Deflection Method	Dimensional Outline		Socket		Direct Interelectrode Capacitance (pF)	Useful Scarred Area (inch <sup>2</sup> )	Signal Electrode Voltage (V)	Grid No. 4 & Field No. 3 Voltage (V)
	Voltage (V)	Current (A)			Overall Length (inch)	Greatest Diameter of Bulb (inch)	Signal Electrode	Base				
7038	6.3 ± 10%	0.6	Magnetic	Magnetic	6 <sup>1</sup> / <sub>4</sub> ± <sup>1</sup> / <sub>4</sub>	1 <sup>1</sup> / <sub>8</sub> ± <sup>1</sup> / <sub>100</sub>	SJ	E8-11	3~6	½ × ¾	100max 10~100	350max 250~300
7735A	6.3 ± 10%	0.6	Magnetic	Magnetic	6 <sup>1</sup> / <sub>4</sub> ± <sup>1</sup> / <sub>4</sub>	1 <sup>1</sup> / <sub>8</sub> ± <sup>1</sup> / <sub>100</sub>	SJ	E8-11	3~6	½ × ¾	100max 10~100	750max 250~300

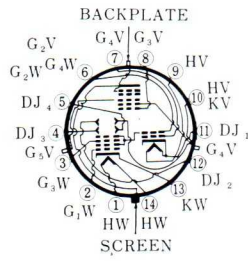

7448

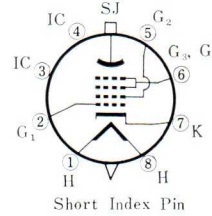
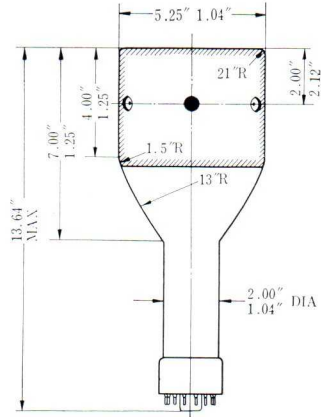

7038 • 7735-A

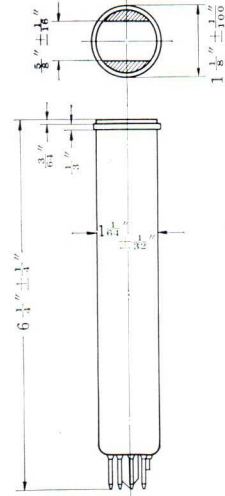

Direct Interelectrode Capacitance		Minimum Useful Screen Diameter	Grid No. 1 Circuit Resistance	Maximum Ratings				Operating Conditions			
Grid No. 1 to All Other Electrodes (pF)	Cathode to All Other Electrodes (pF)			Anode (Ultor) Voltage (V)	Focusing Electrode Voltage (V)	Grid No. 2 Voltage (V)	Grid No. 2 Voltage (V)	Anode (Ultor) Voltage (V)	Focusing Voltage (V)	Grid No. 2 Voltage (V)	Grid No. 1 Voltage (V)
6	5	4 1/4	1.5	12,000	+1,000 -500	500	+0 -125	10,000	0~250	300	-33~-77
6	5	4 1/4	1.5	22,000max 18,000min	3,850	450	+0 -125	20,000	2,220 ~3,160	200	-22~-52

Ratings and Operating Conditions

Section ☆ 1								Writing Section ☆ 2					
Grid No. 3 Voltage (V)	Grid No. 2 Voltage (V)	Grid No. 1 Voltage (V)	Maximum Writing Speed (in/sec)	Number of Half-Tone Steps	Viewing Duration (sec)	Resolution (lines/in)	Brightness (fl)	Grid No. 4 Voltage (V)	Grid No. 3 Voltage (V)	Grid No. 2 Voltage (V)	Grid No. 1 Voltage (V)	Deflection Factors	
												D <sub>1</sub> to D <sub>2</sub> (Vdc/in/kV of Eb <sub>2</sub> )	D <sub>3</sub> to D <sub>4</sub> (Vdc/in/kV of Eb <sub>2</sub> )
200max	200max 10min	-200max +0max	300,000	5	20	50	2,750	2,950max	1,200max	2,950max	-200max +0max		
10~50								2,000	350~750	2,000		36~38	35~47

- ① ☆ 1 Viewing gun ☆ 1 Voltage are shown with respect to cathode of viewing gun.
- ★ 2 Writing gun ☆ 2 Voltage are shown with respect to cathode of writing gun.

Maximum Ratings and Operating Conditions

Grid No. 2 Voltage (V)	Grid No. 1 Voltage (V)	Maximum Dark Current (μA)	Signal Current		Faceplate Illumination		Minimum Peak to Peak Blanking Voltage		Signal to Noise Ratio	Gamma	Faceplate Temperature (C°)	Alignment Field (Gauss)	Focusing Field (Gauss)
			Average (μA)	Peak (μA)	For Film Pick-up (lx)	For Live Pick-up (lx)	When Applied to Grid No. 1	When Applied to Cathode					
350max 300	-125max +0max -45~-100	0.004~0.2	0.1~0.2	0.3~0.4	10,000max 500~3,000	200	75	20	300 : 1	0.65	60max	0~4	40
350max 300	-125max +0max -45~-100	0.004~0.2	0.1~0.2	0.3~0.4	500	10~100	75	20	300 : 1	0.57~0.60	71max	0~4	40



Tokyo Japan

Head Office: 4, 1-chome, Marunouchi, Chiyoda-ku, Tokyo

Tel.: Tokyo (212) 1111 (80 lines)

Cable Address: "HITACHY" TOKYO

Codes: All Codes Used